

# Pacific Northwest National Laboratory

Operated by Battelle for the  
U.S. Department of Energy

## Results of 1998 Spectral Gamma- Ray Monitoring of Boreholes at the 216-Z-1A Tile Field, 216-Z-9 Trench, and 216-Z-12 Crib

D. G. Horton  
R. R. Randall

**RECEIVED**  
**SEP 24 1998**  
**OSTI**

September 1998

**MASTER** *JAT*

**DISTRIBUTION OF THIS DOCUMENT IS UNLIMITED**

Prepared for the U.S. Department of Energy  
under Contract DE-AC06-76RLO 1830



## DISCLAIMER

This report was prepared as an account of work sponsored by an agency of the United States Government. Reference herein to any specific commercial product, process, or service by trade name, trademark, manufacturer, or otherwise does not necessarily constitute or imply its endorsement, recommendation, or favoring by the United States Government or any agency thereof, or Battelle Memorial Institute.

PACIFIC NORTHWEST NATIONAL LABORATORY

*operated by*

BATTELLE

*for the*

UNITED STATES DEPARTMENT OF ENERGY

*under Contract DE-AC06-76RLO 1830*

Printed in the United States of America

Available to DOE and DOE contractors from the  
Office of Scientific and Technical Information, P.O. Box 62, Oak Ridge, TN 37831;  
prices available from (615) 576-8401.

Available to the public from the National Technical Information Service,  
U.S. Department of Commerce, 5285 Port Royal Rd., Springfield, VA 22161



This document was printed on recycled paper.

### DISCLAIMER

This report was prepared as an account of work sponsored by an agency of the United States Government. Neither the United States Government nor any agency thereof, nor any of their employees, makes any warranty, express or implied, or assumes any legal liability or responsibility for the accuracy, completeness, or usefulness of any information, apparatus, product, or process disclosed, or represents that its use would not infringe privately owned rights. Reference herein to any specific commercial product, process, or service by trade name, trademark, manufacturer, or otherwise does not necessarily constitute or imply its endorsement, recommendation, or favoring by the United States Government or any agency thereof. The views and opinions of authors expressed herein do not necessarily state or reflect those of the United States Government or any agency thereof.

## **DISCLAIMER**

**Portions of this document may be illegible in electronic image products. Images are produced from the best available original document.**

**Results of 1998 Spectral Gamma-Ray  
Monitoring of Boreholes at the  
216-Z-1A Tile Field, 216-Z-9 Trench,  
and 216-Z-12 Crib**

D. G. Horton  
R. R. Randall<sup>(a)</sup>

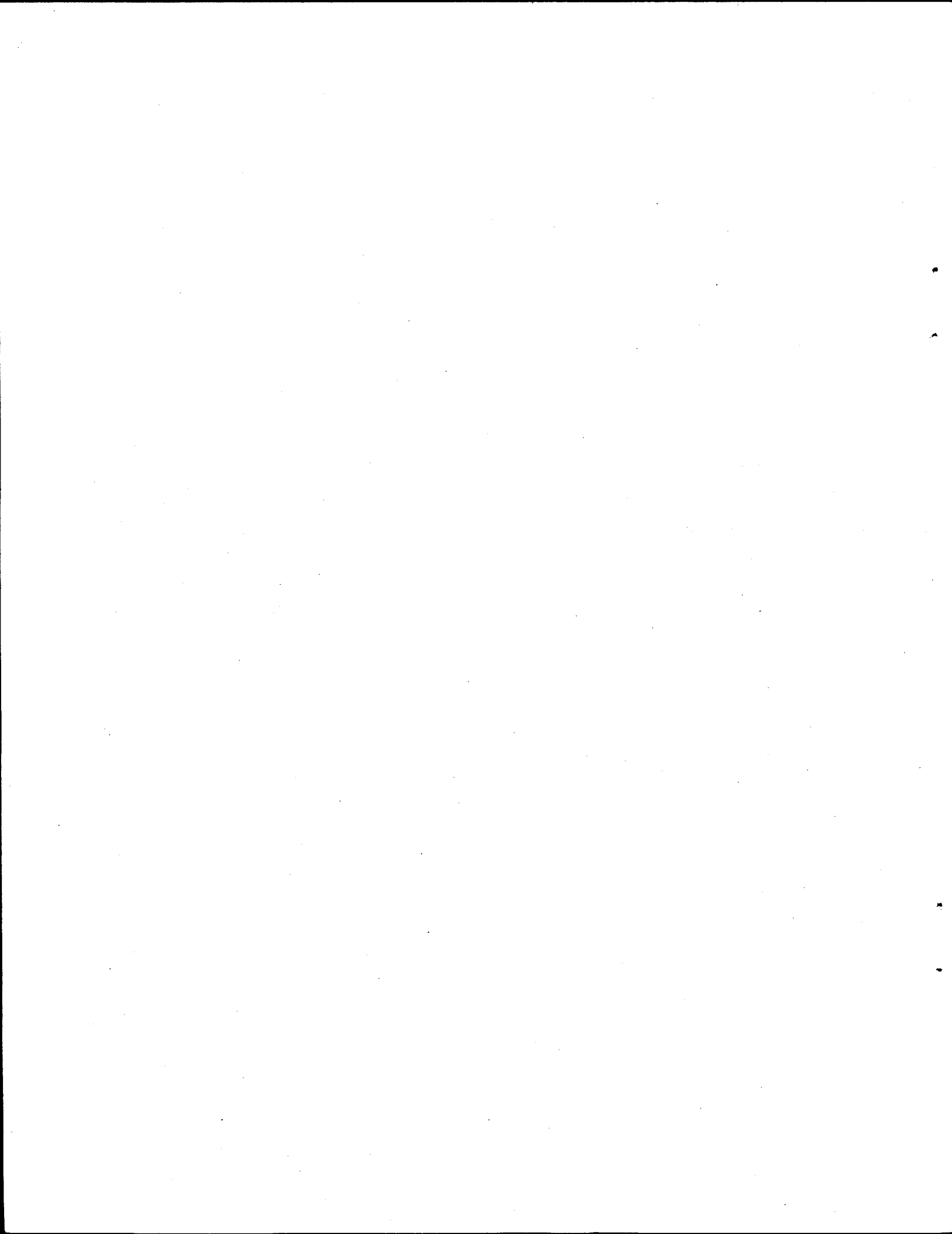
September 1998

Prepared for  
the U.S. Department of Energy  
under Contract DE-AC06-76RLO 1830

Pacific Northwest National Laboratory  
Richland, Washington 99352

---

<sup>(a)</sup>Three Rivers Scientific  
West Richland, Washington 99353

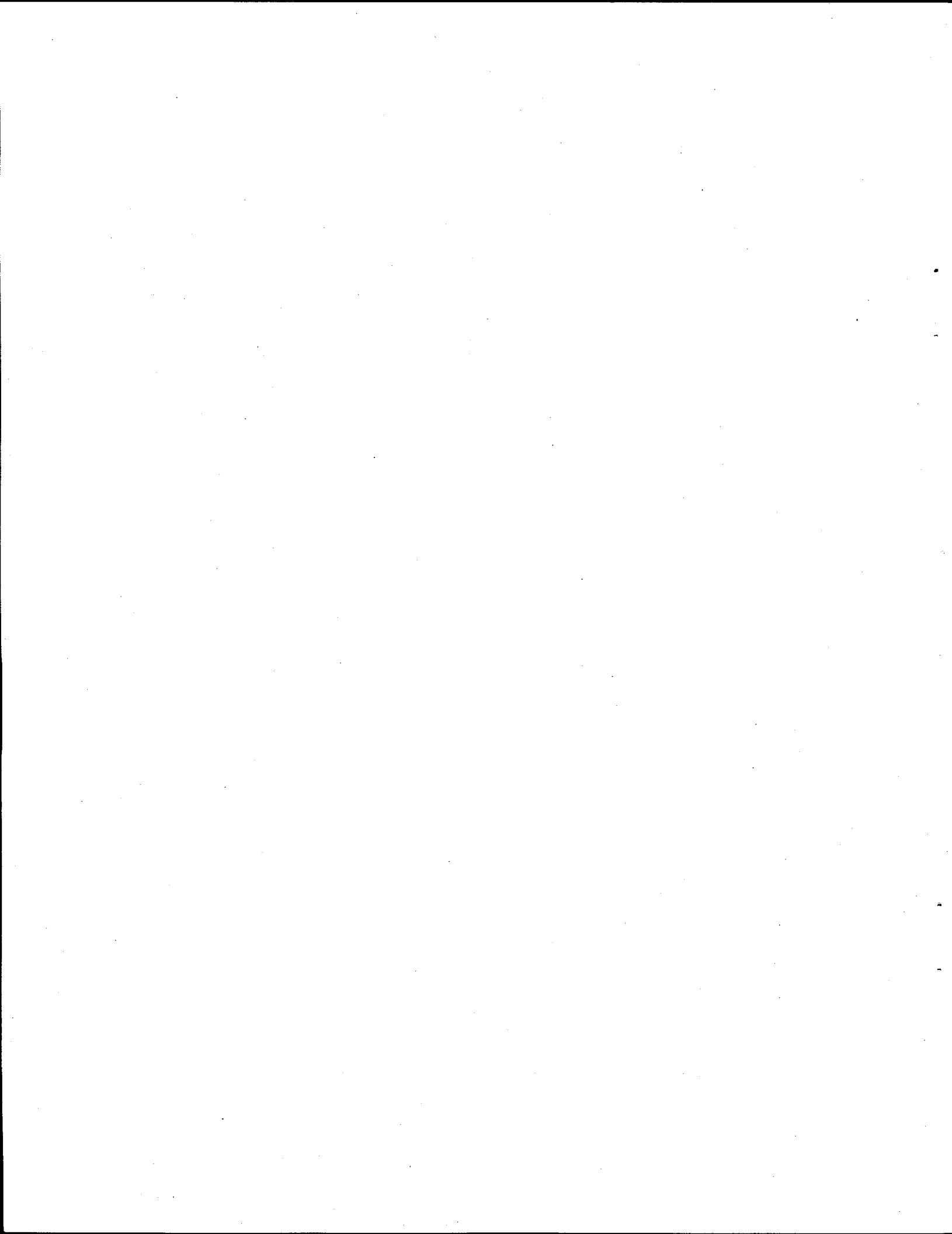


## Summary

In April 1998, 21 boreholes at the 216-Z-1A tile field, 216-Z-9 trench, and 216-Z-12 crib were monitored by spectral gamma-ray logging because they were identified as containing some of the most significant sources of radioactive contamination in the Hanford Site vadose zone.

The 1998 logging revealed that man-made isotopes ( $^{137}\text{Cs}$ ,  $^{233}\text{Pa}$ ,  $^{239}\text{Pu}$ , and  $^{241}\text{Am}$ ) were present in the 216-Z-1A tile field and the 216-Z-12 crib. The maximum activities were found in borehole 299-W18-159 at the tile field:  $^{137}\text{Cs}$  at 23 pCi/g,  $^{233}\text{Pa}$  at 63 pCi/g,  $^{239}\text{Pu}$  at 25,000 nCi/g, and  $^{241}\text{Am}$  at 2,500 nCi/g. The only man-made radionuclide identified at the 216-Z-9 trench was  $^{137}\text{Cs}$  (<1 pCi/g) near the surface in one borehole.

The data collected in 1998 were compared with past log data, suggesting that there have been some changes in radionuclide activity around two boreholes at the tile field and in one borehole from the crib. In one borehole at the tile field,  $^{233}\text{Pa}$  decreased and  $^{137}\text{Cs}$  increased in one zone and  $^{239}\text{Pu}$  decreased in a second zone. In another borehole at the tile field,  $^{233}\text{Pa}$  decreased in one zone and increased in another zone. At the crib, there was an increase in  $^{233}\text{Pa}$  and  $^{239}\text{Pu}$  activities and a possible decrease in  $^{137}\text{Cs}$  in one borehole. It was noted that there were apparent changes in other boreholes, but those apparent changes probably resulted from differences in data collection and data processing between the logging events.



# Contents

Summary .....	iii
1.0 Introduction.....	1.1
1.1 Notes on Units of Measure .....	1.1
1.2 Organization of This Document .....	1.1
2.0 Previous Work.....	2.1
3.0 Geologic and Facility Settings .....	3.1
3.1 Geology of the 200 West Area .....	3.1
3.1.1 Ringold Formation.....	3.1
3.1.2 Plio-Pleistocene Deposits .....	3.4
3.1.3 Hanford Formation .....	3.5
3.1.4 Holocene Deposits .....	3.6
3.2 Geology of the Vadose Zone Beneath the Facilities.....	3.6
3.3 Facility and Effluent Descriptions.....	3.7
3.3.1 216-Z-1A Tile Field.....	3.7
3.3.2 216-Z-9 Trench.....	3.11
3.3.3 216-Z-12 Crib .....	3.14
4.0 Methods.....	4.1
4.1 Boreholes .....	4.1
4.2 Logging Methods.....	4.1
4.2.1 System Calibration.....	4.7
4.2.2 Pre-Log and Post-Log Energy Calibration/Verification.....	4.8
4.2.3 Repeat Logs .....	4.8
4.3 Data Interpretation .....	4.9
5.0 Results.....	5.1
5.1 216-Z-1A Tile Field.....	5.1
5.1.1 Borehole 299-W18-149 .....	5.1
5.1.2 Borehole 299-W18-158 .....	5.3
5.1.3 Borehole 299-W18-159 .....	5.3

5.1.4 Borehole 299-W18-167 .....	5.6
5.1.5 Borehole 299-W18-168 .....	5.6
5.1.6 Borehole 299-W18-169 .....	5.6
5.1.7 Borehole 299-W18-173 .....	5.8
5.1.8 Borehole 299-W18-175 .....	5.8
5.2 216-Z-9 Trench.....	5.10
5.3 216-Z-12 Crib .....	5.10
5.3.1 Borehole 299-W18-08 .....	5.10
5.3.2 Borehole 299-W18-152 .....	5.12
5.3.3 Borehole 299-W18-153 .....	5.12
5.3.4 Borehole 299-W18-156 .....	5.12
5.3.5 Borehole 299-W18-179 .....	5.14
5.3.6 Borehole 299-W18-181 .....	5.14
5.3.7 Borehole 299-W18-182 .....	5.18
5.3.8 Borehole 299-W18-183 .....	5.18
5.3.9 Borehole 299-W18-185 .....	5.18
6.0 Discussion .....	6.1
6.1 Changes in Subsurface Radionuclide Distribution .....	6.1
6.2 Comparison of Borehole Spectral Gamma-Ray Logs and Laboratory Data .....	6.2
6.3 Stratigraphic Control of Contaminant Distribution .....	6.2
6.4 $^{233}\text{Pa}$ as Surrogate for $^{237}\text{Np}$ .....	6.3
6.5 $^{208}\text{Th}$ .....	6.3
6.6 Gross Gamma and Radon .....	6.4
6.7 Neutron Flux.....	6.4
7.0 Conclusions.....	7.1
8.0 References.....	8.1
Appendix - Borehole Logging Data .....	A.1

## Figures

3.1	Hanford Site Location Map.....	3.2
3.2	Hanford Site Stratigraphy .....	3.3
3.3	Hydrogeologic Units Beneath the 216-Z-1A Tile Field and 216-Z-9 Trench and Beneath the 216-Z-12 Crib.....	3.8
3.4	Map Showing Location of the 216-Z-1A Tile Field, 216-Z-9 Trench, and 216-Z-12 Crib .....	3.9
3.5	Plan View and Cross Section Showing Construction Details of the 216-Z-1A Tile Field .....	3.10
3.6	Construction Details for the 216-Z-9 Trench.....	3.13
3.7	Construction Details for the 216-Z-12 Crib .....	3.15
4.1	Borehole Locations at the 216-Z-1A Tile Field .....	4.4
4.2	Borehole Locations at the 216-Z-9 Trench .....	4.5
4.3	Borehole Locations at the 216-Z-12 Crib .....	4.6
5.1	Comparison of Activities Versus Depth from 1993 and 1998 Log and Laboratory Data in Borehole 299-W18-149.....	5.2
5.2	Comparison of $^{137}\text{Cs}$ and $^{233}\text{Pa}$ Activities Versus Depth from 1991 and 1998 Log Data in Borehole 299-W18-159.....	5.5
5.3	$^{233}\text{Pa}$ Activity Versus Depth in Borehole 299-W18-167.....	5.7
5.4	Comparison of $^{233}\text{Pa}$ , $^{241}\text{Am}$ , and $^{239}\text{Pu}$ Activities Versus Depth from 1993 and 1998 Log and Laboratory Data in Borehole 299-W18-175.....	5.9
5.5	Comparison of $^{233}\text{Pa}$ Activity Versus Depth from 1998 and 1993 Log Data in Borehole 299-W18-175.....	5.11
5.6	Comparison of $^{233}\text{Pa}$ Activity Versus Depth from 1993 and 1998 Log Data in Boreholes 299-W18-152 and 299-W18-153 .....	5.13
5.7	Comparison of $^{233}\text{Pa}$ and $^{239}\text{Pu}$ Activities Versus Depth from 1993 and 1998 Log Data in Borehole 299-W18-179 .....	5.15

5.8 Comparison of $^{233}\text{Pa}$ and $^{137}\text{Cs}$ Activities Versus Depth from 1998 and 1993 Log Data in Borehole 299-W18-181.....	5.16
5.9 Comparison of $^{239}\text{Pu}$ and $^{241}\text{Am}$ Activities Versus Depth from 1993 and 1998 Log and Laboratory Data in Borehole 299-W18-181 .....	5.17
5.10 $^{137}\text{Cs}$ and $^{233}\text{Pa}$ Activities Versus Depth in Borehole 299-W18-182.....	5.19
5.11 Comparison of $^{239}\text{Pu}$ and $^{241}\text{Am}$ Activities Versus Depth from 1998 Log and Laboratory Data.....	5.20
6.1 Comparison of Gross Gamma-Ray Plots from 1998 and 1993, Illustrating Radon Pumping in Borehole 299-W18-169.....	6.5

## Tables

3.1 Operational History for the 216-Z-1A Tile Field.....	3.11
3.2 Waste Inventories for the Monitored Facilities.....	3.12
4.1 Boreholes Logged at Plutonium Finishing Plant Liquid Waste Disposal Facilities .....	4.2

## 1.0 Introduction

This document describes the results of fiscal year 1998 vadose zone monitoring of three inactive liquid waste disposal facilities associated with the Plutonium Finishing Plant: the 216-Z-1A tile field, the 216-Z-9 trench, and the 216-Z-12 crib. Monitoring consisted of spectral gamma-ray logging of 21 boreholes. This work was performed by Pacific Northwest National Laboratory<sup>1</sup> in conjunction with Three Rivers Scientific and Waste Management Federal Services, Inc. Northwest Operations.

These three liquid waste disposal facilities were chosen for monitoring because they were identified as containing some of the most significant sources of radioactive contamination in the Hanford Site vadose zone (Johnson in Hartman and Dresel 1997). The basic question addressed by this logging activity is "Has the configuration of subsurface contamination changed since it was last measured?" Previous borehole logging and laboratory analyses provide the baseline data to help answer this question.

### 1.1 Notes on Units of Measure

This document uses metric units except in discussions of boreholes and the logging results from boreholes where English units are used. The decision to use English units was based on several factors. First, most historical information concerning the drilling and logging of boreholes is in English units. Second, new logging data were obtained in English units (feet and curies), and the software to process the raw data and the software for interpretation of the data are in English units. Finally, most users of borehole and logging data are familiar with parameters such as casing diameter in English units and with radionuclide activities in English units.

The following are some useful conversions between English units and metric equivalents:

- 1 foot = 0.3048 meter
- 1 inch = 2.54 centimeters
- 1 curie =  $3.7 \times 10^{10}$  becquerels
- 1 pCi =  $3.7 \times 10^{-2}$  becquerel.

### 1.2 Organization of This Document

This document is organized into several sections and an appendix, which give the previous work, the geology and facility descriptions, the methods used to obtain and evaluate the gathered data, the results for each facility evaluated, a discussion of the results, and the references cited in the text.

---

<sup>1</sup> Pacific Northwest National Laboratory is operated by Battelle for the U.S. Department of Energy.

## 2.0 Previous Work

The latest comprehensive collection and discussion of scintillation probe profiles at the Plutonium Finishing Plant area is included in Fecht et al. (1977). They interpreted the scintillation probe profiles for ~100 crib facilities, including the 216-Z-1A tile field, 216-Z-9 trench, and 216-Z-12 crib. They compared the profiles available at that time with previous profiles to interpret changes in subsurface distribution of gamma-emitting radionuclides.

At the 216-Z-1A tile field, Fecht et al. (1977) identified gamma contamination in three boreholes. Boreholes 299-W18-57 and 299-W18-58 showed increased gamma activity between 6.1 and 16.8 and between 13.7 and ~28 m, respectively, between 1965 and 1968. Borehole 299-W18-56 showed a zone between 11 and 21 m with gamma activity above background, but the intensity of the activity decreased between 1965 and 1973. All other logged boreholes at 216-Z-1A had no gamma intensity above background levels.

At the 216-Z-9 trench, Fecht et al. (1977) found contamination in two boreholes (299-W15-8 and 299-W15-86) between 15.2 and 38.1 m. The remainder of the boreholes showed near-background levels of radiation. For the two boreholes with elevated gamma activity, they concluded that gamma intensity decreased as a result of radioactivity decay since the previous logging.

At the 216-Z-12 crib, Fecht et al. (1977) found that gamma contamination near the head end of the crib remained detectable in four boreholes (299-W18-5, 299-W18-8, 299-W18-69, and 299-W18-71) at 6.7 m since the beginning of logging in 1967. They concluded that minor redistribution of contaminants had occurred from operations.

Scintillation probe data have been collected subsequent to Fecht et al. (1977) (see Additon et al. 1978a and 1978b) but no comparable discussion or presentation of the data has been made.

In 1991, Chamness et al. (1991) compiled a database of all known geophysical logging done in the 200 Aggregate Area. That compilation was used, as well as results from the few subsequent and unpublished spectral gamma logging events in this area, to delineate subsurface contamination (DOE 1992). The 1992 DOE report included isoconcentration maps of elevated gamma activities beneath the 216-Z-1A, 216-Z-9, and 216-Z-12 facilities.

Brodeur et al. (1993) reported on gross gamma and spectral gamma logging done in 1992 and 1993 for the 200 Areas' aggregate area management study. In 1993, Schlumberger and the U.S. Department of Energy's Grand Junction Projects Office logged several boreholes at Plutonium Finishing Plant waste disposal facilities for the Arid Site Integrated Demonstration Project. Schlumberger produced gross gamma logs from four boreholes at 216-Z-9 and from one borehole at 216-Z-12 (as well as other "oil field" type logs such as reservoir saturation and porosity logs) but their results have not been described or published. At about the same time, the Grand Junction Projects Office logging team produced prompt fission neutron logs of 10 boreholes, including 4 at 216-Z-1A and 1 each at 216-Z-9 and 216-Z-12. Those results have not been published but a draft report states that all the boreholes at the 216-Z-1A tile

field and one borehole in the 216-Z-12 crib showed large concentrations of fissionable isotopes. Two of the boreholes in 216-Z-1A had been logged with the prompt fission neutron tool in 1978 and again in 1984 (prior to the 1993 logging). The distribution of contaminants (undifferentiated fissionable isotopes, primarily  $^{235}\text{U}$ ,  $^{239}\text{Pu}$ , and  $^{241}\text{Pu}$ ) agreed well with the previous logs, indicating that fissionable radionuclides, including plutonium, had not moved substantially over the span of 15 years.

In addition to geophysical borehole logging, some analytical (laboratory) results exist from drilling and sampling activities at each of the 216-Z-1A, 216-Z-9, and 216-Z-12 facilities. Ridgway et al. (1971) reviewed previous soil sampling at 216-Z-9 and presented laboratory results for plutonium concentrations from their "third sampling" from split tube samples. Their samples were all obtained from  $\leq 3$  m, so they add little information to contaminant distribution beneath the trench. Smith (1973) reported results of a gamma survey, an infrared temperature survey, and a neutron survey of the surface (top 13 cm in the case of the neutron survey) of the 216-Z-9 trench in support of nuclear reactivity evaluations. Smith also reported results of laboratory analyses for plutonium and americium from shallow ( $< 3$  m) boreholes drilled through the trench floor.

Price et al. (1979) drilled and sampled 16 boreholes at the 216-Z-1A tile field for the purpose of delineating the distribution of subsurface contamination at that facility. Approximately 400 samples from those boreholes were analyzed for plutonium and americium activity. Their results were summarized as cross sections through the tile field, showing plutonium and americium distributions. Their cross sections have been the basis for subsequent visualizations of contamination at that facility.

Kasper (1982) did a study at the 216-Z-12 crib in a manner similar to Price et al. (1979). Kasper reviewed existing data and sampled seven new boreholes. That analysis resulted in cross sections of the crib with contours of the plutonium distribution down to the 1-pCi/g level. Also, laboratory analyses were provided in an unpublished letter report by J. L. Buelt, Pacific Northwest National Laboratory, for  $^{137}\text{Cs}$ ,  $^{154}\text{Eu}$ ,  $^{237}\text{U}$ ,  $^{239}\text{Pu}$ , and  $^{241}\text{Am}$  obtained from three 3-m-long cores sampled during drilling of 4 new boreholes in support of a large-scale, in situ vitrification project at the 216-Z-12 crib. Tables of results and cross sections of concentration versus depth were given in the letter report.

All of the previous geophysical logging results and the laboratory analytical results are available and serve as a baseline against which results collected for this monitoring effort are compared.

## 3.0 Geologic and Facility Settings

The Hanford Site is located in the central Columbia Plateau of southeastern Washington State (Figure 3.1). The Columbia Plateau is underlain by more than 3,000 m of tholeiitic basalt flows comprising the Columbia River Basalt Group. Sedimentary units of the Ellensburg Formation are interbedded with the basalts. The basalt flows were folded and faulted, beginning in Miocene time and continuing to the present, to form a broad structural and topographic basin punctuated with asymmetric anticlinal ridges. The ridges delineate several topographic basins within the Columbia Plateau, and the Hanford Site lies within one of these basins, the Pasco Basin. The Hanford Site is bounded by Umtanum Ridge, Yakima Ridge, and the Rattlesnake Hills on the west; the Saddle Mountains to the north; the Palouse Slope to the east; and Rattlesnake Mountain and Rattlesnake Hills to the south. The regional geology of the Columbia Plateau and the Pasco Basin have been discussed in detail in DOE (1988) and Delaney et al. (1991).

The Columbia River Basalt Group is overlain by thick accumulations of clastic sedimentary deposits in the Pasco Basin. These suprabasalt deposits include the Miocene to Pliocene Ringold Formation, the Plio-Pleistocene unit, and the Pleistocene Hanford formation. Much of the surface of the Hanford Site is covered by a thin veneer of Holocene alluvial and eolian sediment.

### 3.1 Geology of the 200 West Area

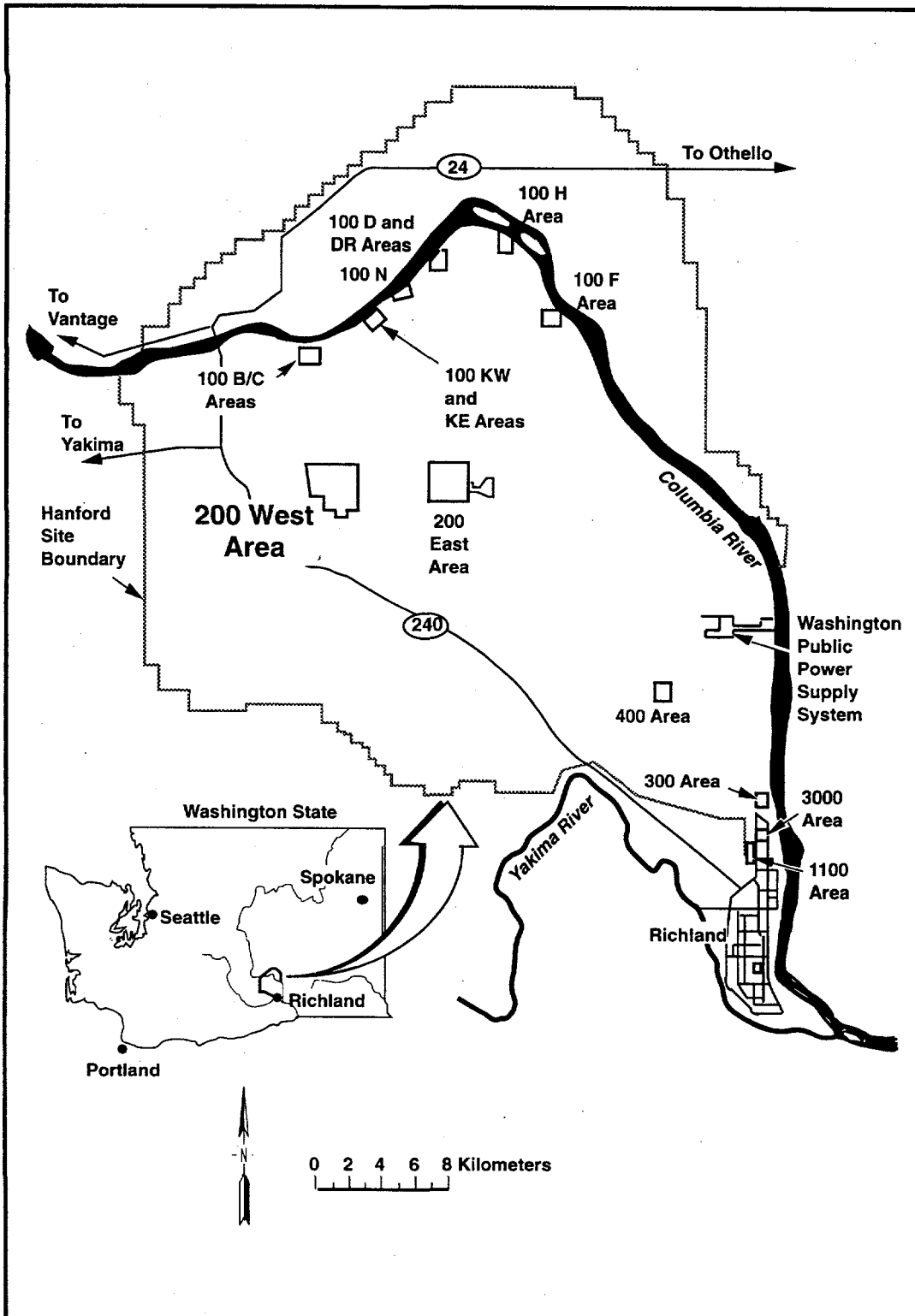
The 200 West Area lies in the west-central part of the Hanford Site (see Figure 3.1). Lindsey (1991a) described the geology of the 200 West Area in detail and much of this section is taken from his description. Figure 3.2 shows a generalized stratigraphy applicable to the central part of the Hanford Site. Not all units shown on Figure 3.2 are present in the 200 West Area.

The Elephant Mountain Member of the Saddle Mountains Basalt is the uppermost basalt unit beneath the 200 West Area. The Elephant Mountain Member dips to the southwest into the Cold Creek syncline, which trends northwest-southeast just south of the 200 West Area. The Elephant Mountain Member is continuous everywhere beneath the 200 West Area.

#### 3.1.1 Ringold Formation

The Miocene to Pliocene Ringold Formation has been described in terms of five facies associations based on lithology, petrology, stratification, and pedogenic alteration (Lindsey 1991b, 1996). The facies are described below.

1. Fluvial gravels consist of clast-supported granule to cobble gravel with a sandy matrix. Sands and muds (overbank facies) are interbedded with the gravels. Low-angle to planar stratification, massive bedding, and large-scale cross bedding are found in outcrops. The fluvial gravel facies were deposited by braided streams with wide, shallow, shifting channels (Lindsey 1991b).



RP980700049.8

Figure 3.1. Hanford Site Location Map (after Rohay et al. 1994)

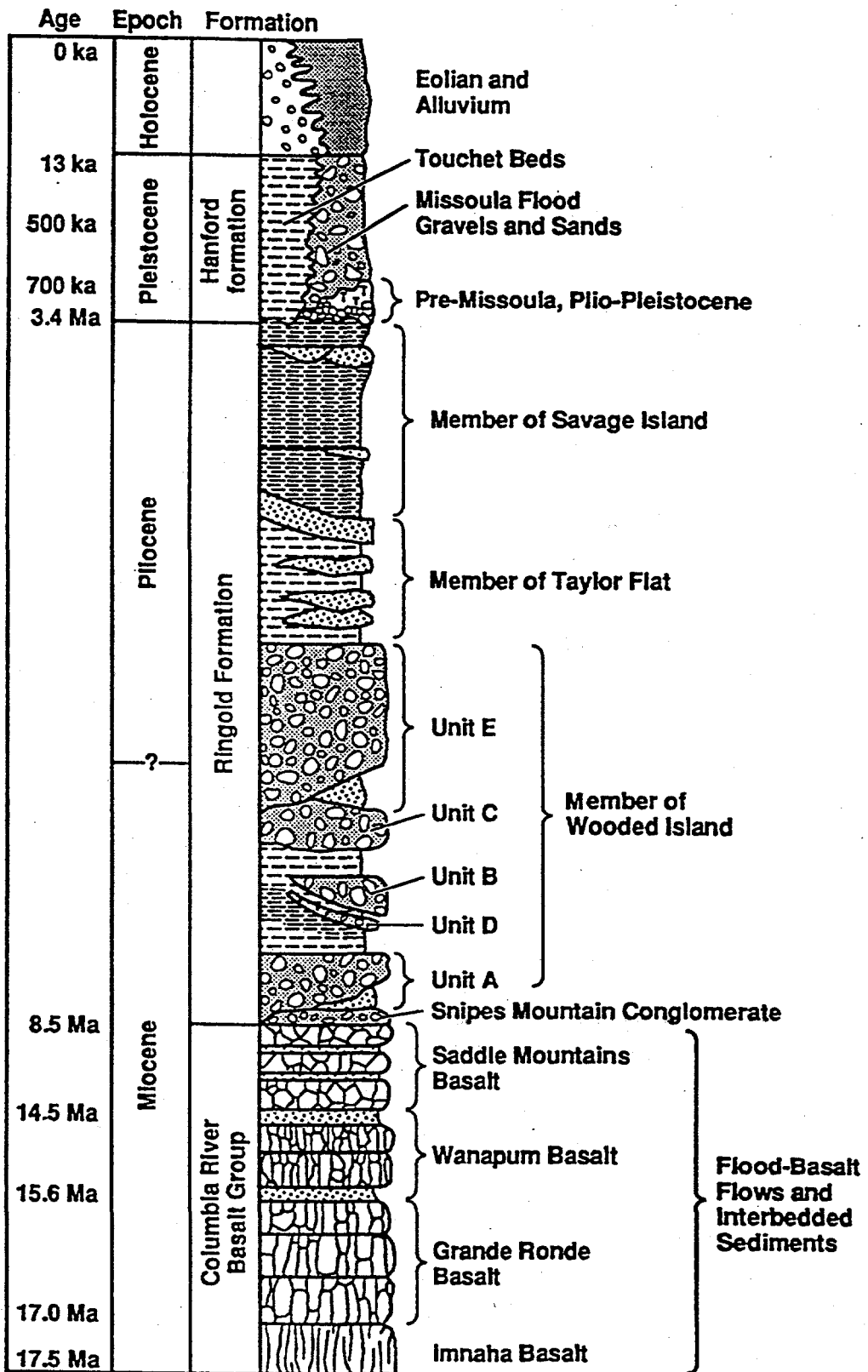


Figure 3.2. Hanford Site Stratigraphy (after Lindsey 1996)

2. Fluvial sands display cross bedding and cross laminations. Lenticular, silty sands and clays (overbank facies) up to 3 m thick and gravels (fluvial gravel facies) <0.5 m thick are interbedded with the sands. The fluvial sands are interpreted as being deposited in wide, shallow stream channels (Lindsey 1991b).
3. Overbank deposits consist of laminated to massive silt, silty fine-grained sand, and paleosols with variable quantities of pedogenic calcite. Overbank deposits occur as <0.5- to 2-m-thick lenticular beds in the fluvial gravel and fluvial sand facies and as up to 10-m-thick laterally continuous sedimentary units. The overbank facies represent proximal levee to distal floodplain deposition (Lindsey 1991b).
4. Lacustrine deposits consist of plane laminated to massive clay with thin silt and silty sand interbeds. These commonly exhibit soft sediment deformation features. The lacustrine facies were deposited in a lake environment under standing water to deltaic conditions (Lindsey 1991b).
5. Alluvial fan deposits consist of massive to crudely stratified detritus. These deposits are generally basalt rich and occur around the periphery of the basin. The alluvial fan facies were deposited as debris flows along uplifted ridges and in side streams (Lindsey 1991b).

Lindsey (1991b) divided the lower part of the Ringold Formation (the member of Wooded Island) into five stratigraphic intervals each dominated by the fluvial gravel facies. These gravels are designated (from oldest to youngest) as units A, B, C, D, and E and are separated by deposits of overbank and lacustrine facies (see Figure 3.2). The five gravel units are overlain by a sequence of fluvial sands, overbank deposits, and lacustrine deposits.

In the 200 West Area, only two of the gravel units are present: unit A and E. Both gravel units contain lenticular, discontinuous beds of sand and silt. The two units are separated by deposits of the lacustrine facies known as the lower mud unit. Unit E is overlain by the sands and muds of the member of Taylor Flat (see Figure 3.2). Both unit A and the lower mud unit thicken and dip toward the axis of the Cold Creek syncline. The thickness of the lower mud unit is irregular and pinches out in the northeastern corner of the 200 West Area (Lindsey 1991a). Where the lower mud unit is absent, it is difficult to distinguish gravel units A and E. Unit E also dips to the southeast but, unlike the lower unit A, unit E thins in the direction of dip.

The member of Taylor Flat is dominated by the fluvial sand and overbank facies (Lindsey 1996) and is discontinuous in the 200 West Area as a result of post-Ringold erosion. It is present in the central, west, and northwest portions of the 200 West Area and is absent in the east, southeast, and south portions.

### 3.1.2 Plio-Pleistocene Deposits

The Plio-Pleistocene deposits overlie the Ringold Formation and, in the 200 West Area, consist of sidestream alluvial deposits, calcic paleosols, and the early "Palouse" soil. The pre-Missoula gravels are absent under the 200 West Area. The paleosols consist of massive calcium carbonate-cemented silt, sand,

and gravel and interbedded caliche-rich and caliche-poor silts and sands. The thickness of the unit is very irregular, and Lindsey (1991a) speculates that erosional windows exist through the unit in the 200 West Area.

The early Palouse soil consists of massive, compact, loess-like silt and minor, fine-grained sand (Tallman et al. 1979). Calcium carbonate is present in the unit but is not as abundant as in the underlying paleosols. The thickness of the unit is irregular; it is thickest in the southwest, southeast, and central parts of the 200 West Area (Lindsey 1991a).

### 3.1.3 Hanford Formation

The majority of the vadose zone in the 200 West Area is located in the Hanford formation. The Hanford formation overlies the Plio-Pleistocene deposits and consists of pebble to boulder gravels, fine- to coarse-grained sands, and silt and has been divided into three facies: 1) gravel dominated, 2) sand dominated, and 3) silt dominated (also known as the slackwater deposits, the "Touchet Beds," and the rhythmite facies). All three facies of the Hanford formation are found beneath the 200 West Area.

Deposits of the gravel-dominated facies consist of coarse-grained basaltic sand and granule to boulder gravel. They show massive bedding, plane to low-angle bedding, and large-scale planar cross bedding. In places, the gravels are matrix poor and have an open-framework texture. Sand and silt beds occur throughout the gravel-dominated facies. The Hanford formation gravels were deposited in main flood channels by high-energy flood waters of the catastrophic glacial floods.

The sand-dominated facies consist of fine- to coarse-grained sand and gravel. The deposits show plane lamination, bedding, and, less commonly, channel-fill structures. The sands may contain pebble-gravel interbeds and silty interbeds <1 m thick (Lindsey 1991a). The silt content of the sands is variable and, where it is low, a well-sorted and open-framework texture results. The sand facies were deposited adjacent to the main flood channels during the waning stages of flooding.

The silt-dominated facies consist of thinly bedded, plane laminated, and ripple cross laminated silt and fine to coarse sand. The deposits are commonly normally graded and rhythmically bedded deposits, with beds ranging from a few centimeters to several tens of centimeters thick (Bjornstad et al. 1987, DOE 1988). These sediments were deposited under slackwater conditions and in backflooded areas.

Lindsey (1991a) divided the Hanford formation beneath the 200 West Area into two sequences: a fine-grained sequence and a coarse-grained sequence. The fine-grained sequence is 0 to 32 m thick and consists dominantly of silt, silty sand, and sand of the silt-dominated facies interbedded with coarser sands of the sand-dominated facies. Thin beds of the gravel facies are found locally in the fine-grained sequence. The fine-grained sequence thickens to the south, where the proportion of silt facies within the sequence predominates. The fine-grained sequence is absent in the northern part of the 200 West Area.

The coarse-grained sequence mainly consists of the gravel-dominated facies but deposits of the sand-dominated facies predominate locally. Laterally discontinuous deposits of the silt-dominated facies are also present but are minor in abundance. The coarse-grained sequence is up to 45 m thick but laterally

discontinuous under the 200 West Area. The coarse-grained sequence overlies the fine-grained sequence in the 200 West Area and in the central part of the 200 West Area, the coarse-grained sequence directly overlies the Plio-Pleistocene unit, where the lower fine-grained sequence is absent.

### 3.1.4 Holocene Deposits

Holocene eolian sheet sands blanket part of the 200 West Area. These sands consist of very fine- to medium-grained sands and silty sands. The eolian deposits have been removed from much of the area by construction activities. Where the eolian sands are found, they tend to be in thin sheets  $\leq 3$  m thick (Lindsey 1991a). Dunes generally are not as well developed in the 200 West Area as they are at other places on the Hanford Site.

## 3.2 Geology of the Vadose Zone Beneath the Facilities

Rohay et al. (1994) refined the geology beneath the site of the 200 West Area carbon tetrachloride expedited response action in the central part of the 200 West Area. They presented a detailed description of the stratigraphic section, a discussion of the hydrogeology of the vadose zone and unconfined aquifer, and several cross sections interpreting the subsurface at the expedited response action site.

The three sites monitored for this study (the 216-Z-1A tile field, the 216-Z-9 trench, and the 216-Z-12 crib) are all within the area of the expedited response action, and the following description of the geology and hydrogeology of the monitored sites is taken largely from Rohay et al. (1994).

The water table beneath the area is within the Ringold unit E gravels at  $\sim 142$  m elevation. The top of the Ringold unit E varies between 150 and 167 m elevation in that area, but averages  $\sim 160$  m elevation. Rohay et al. (1994) found the Ringold unit E to be absent in one borehole (299-W15-7) used by them for stratigraphic correlations. However, the Ringold unit E is present beneath all three of the facilities being discussed in this document.

The Plio-Pleistocene unit overlies the Ringold unit E beneath all three monitored facilities. The Plio-Pleistocene unit is at  $\sim 160$  m elevation and is  $\sim 4$  m thick at 216-Z-1A (Price et al. 1979), at  $\sim 169$  m elevation and  $\sim 10$  m thick at 216-Z-9 (Rohay et al. 1994), and at  $\sim 169$  m elevation and  $\sim 2$  m thick at 216-Z-12 (Kasper 1982). The Plio-Pleistocene unit consists of eolian silt that is generally compact and massive. Caliche content is commonly  $\geq 7\%$  and is  $>30\%$  in some boreholes in this area (Price et al. 1979).

Rohay et al. (1994) divided the Hanford formation into five hydrogeologic units for purposes of description at the carbon tetrachloride expedited response action site. Their units are listed below. The terms in brackets denote the general facies composition of each of their units.

1.  $H_{uf}$  - Hanford gravelly sand and sand (upper fine unit) [sand-dominated facies]
2.  $H_{uc}$  - Hanford gravels (upper coarse unit) [gravel-dominated facies]
3.  $H_f$  - Hanford sand (fine unit) [sand-dominated facies]

4. H<sub>lc</sub> - Hanford sandy gravel (lower coarse unit) [gravel-dominated facies]
5. H<sub>lf</sub> - Hanford interbedded silt and fine sand (lower fine unit) [silt-dominated facies].

Figure 3.3 shows the hydrostratigraphy at each of the three facilities being discussed in this document. The Hanford upper fine unit is present at all three facilities but is thinner than the thickness of the backfill material at 216-Z-1A and 216-Z-12. The majority of the Hanford formation present at all three facilities is the Hanford upper coarse unit and the underlying Hanford fine unit. The thickness of the upper coarse unit averages ~11, 10, and 14 m at 216-Z-1A, 216-Z-9, and 216-Z-12, respectively (thicknesses at 216-Z-1A and 216-Z-9 are from data reported in Rohay et al. 1994, and the thickness at 216-Z-12 is interpreted from cross sections in Kasper 1982). The thickness of the Hanford fine unit averages ~13, 20, and 20 m at 216-Z-1A, 216-Z-9 and 216-Z-12, respectively. The Hanford lower coarse unit is present at 216-Z-1A, where it is <1 to ~14 m thick; at 216-Z-12, where it is 15 to 20 m thick; and is absent at 216-Z-9. The Hanford lower fine unit is present in only some of the boreholes at 216-Z-1A, where it ranges in thickness from ~1 to ~12 m.

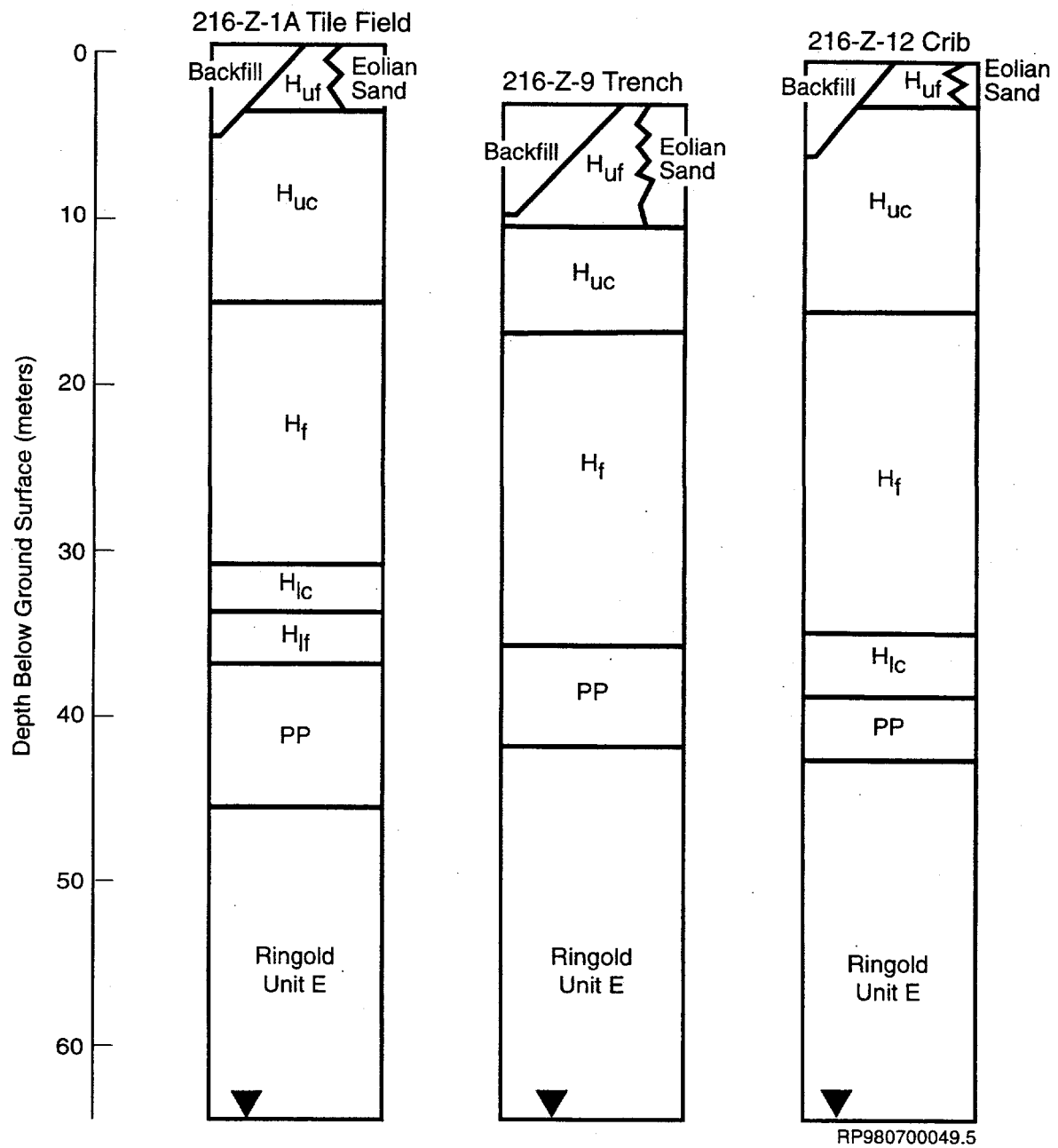
The detailed lithology has been logged and published by Price et al. (1979) for boreholes at 216-Z-1A and is shown on cross sections in Kasper (1982) for 216-Z-12. No published logs for boreholes at 216-Z-9 exist, but the driller's logs for boreholes at that facility give some indication of the heterogeneities in the Hanford formation. Relatively small-scale differences in lithology can be an important control on contaminant distribution in some boreholes (Section 5.0).

### 3.3 Facility and Effluent Descriptions

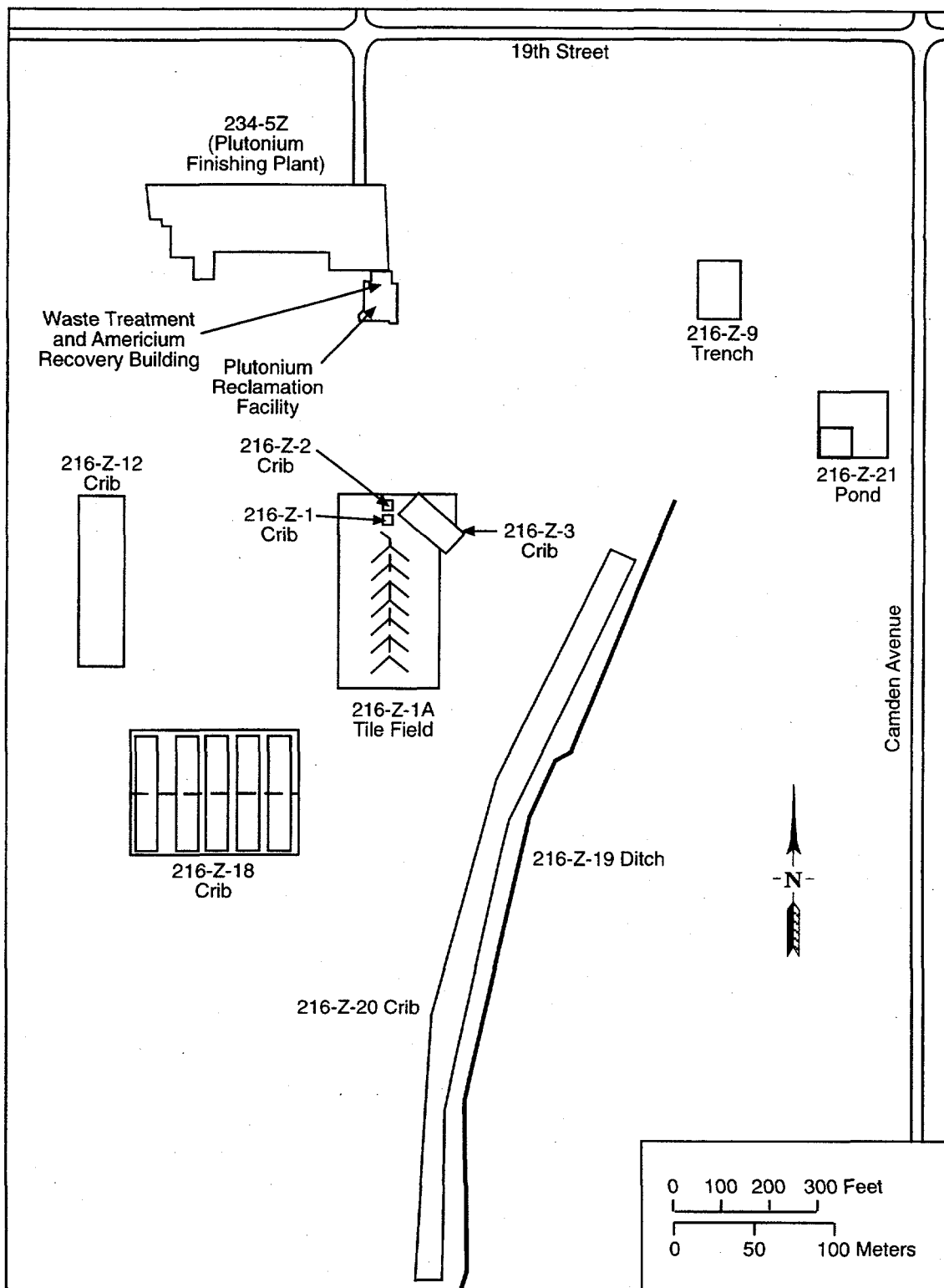
#### 3.3.1 216-Z-1A Tile Field

The 216-Z-1A tile field is located south of the 234-5Z Building in the 200 West Area and immediately south of the 216-Z-1 and 216-Z-2 cribs (Figure 3.4). The tile field is ~60 m wide by 110 m long. Excavated to 5.8 m in depth with inward sloping side walls, a central floor dimension of ~35 by 84 m results (Price et al. 1979). The floor of the excavation was covered by a 1.2-m-thick cobble layer before placing a herringbone pattern of 20-cm-dia. clay pipe for waste distribution (Price et al. 1979). The 85.4-m-long central distributor pipe runs north-south and has 7 pairs of 21.4-m-long laterals spaced 10.7 m apart. The distribution pipe was covered by 15 cm of cobbles and 1.5 m of sand and gravel. Prior to reactivation of the tile field in 1964, a sheet of polyethylene covered by 30 cm of sand and gravel was added to the top of the facility (Price et al. 1979). Figure 3.5 shows construction details of the tile field; specific construction details differ among sources.

The operational history of the tile field is summarized in Table 3.1. The tile field operated from 1949 to 1969. Initially, the tile field received overflow from the 216-Z-1 and 216-Z-2 cribs. Later, liquid waste was routed directly to the tile field. Twice in its history, the inlet point was moved farther from the head end of the tile field. This resulted in distribution of contaminants along the entire length of the tile field. The tile field received between 5,200,000 and 6,200,000 L of liquid waste during its operable life (DOE 1992), which was ~60% of its calculated, specific retention volume (Price et al. 1979).

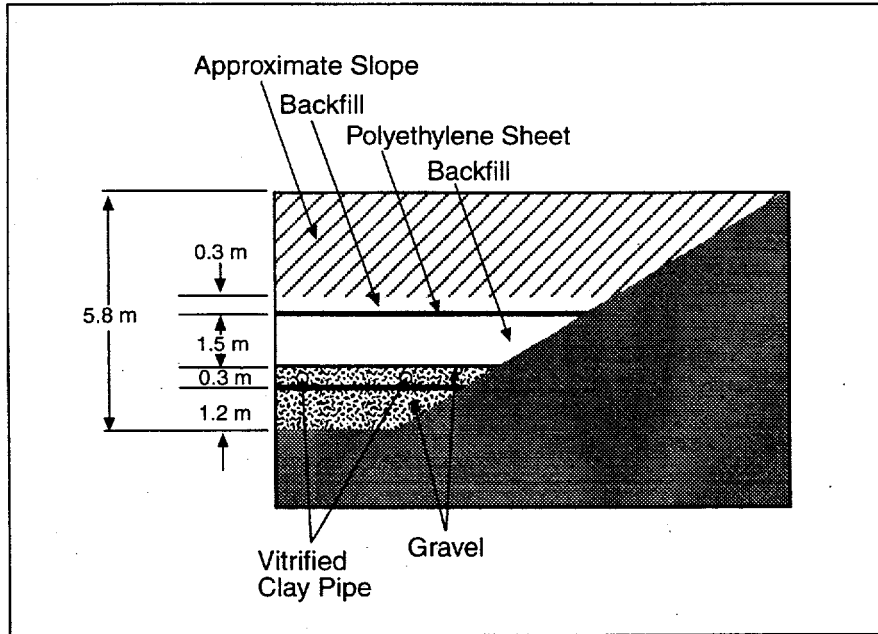
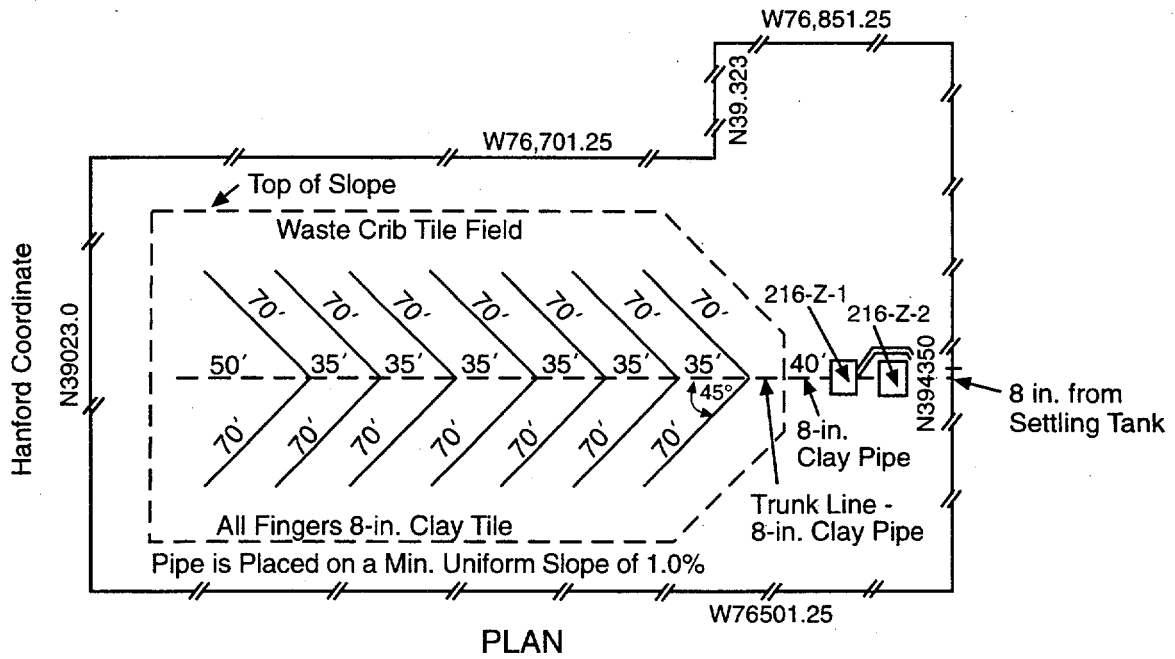


**Figure 3.3.** Hydrogeologic Units Beneath the 216-Z-1A Tile Field and 216-Z-9 Trench (modified from Rohay et al. 1994) and Beneath the 216-Z-12 Crib (stratigraphy interpreted from Kasper 1982)



RP980700049.1

**Figure 3.4.** Map Showing Location of the 216-Z-1A Tile Field, 216-Z-9 Trench, and 216-Z-12 Crib (after Rohay et al. 1994)



RP980700049.17

**Figure 3.5.** Plan View (top from Wood 1958) and Cross Section (bottom from Price et al. 1979) Showing Construction Details of the 216-Z-1A Tile Field

**Table 3.1. Operational History for the 216-Z-1A Tile Field (after DOE 1992)**

Service Dates		Operations
From	To	
6/49	6/52	Along with 216-Z-1 and 216-Z-2 cribs received process, analytical, and development laboratory wastes from 234-5Z Building via the 241-Z-361 settling tank.
6/52	3/59	216-Z-1 and 216-Z-2 cribs were bypassed. Received the above wastes via overflow from the 216-Z-3 crib.
3/59	5/64	Inactive.
5/64	8/64	Received aqueous waste and organic waste from the Plutonium Reclamation Facility.
8/64	5/66	Received 242-Z Building waste and americium recovery (242-Z) waste in addition to the above.
5/66	6/66	Along with 216-Z-1 and 216-Z-2 cribs received 236-Z Building aqueous and organic waste and 242-Z Building waste and the distribution point in tile field was moved from the "a" section 30.5 m down the main trunk to the "b" section (Section 4.0 identifies the sections).
6/66	10/67	216-Z-1 and 216-Z-2 cribs were inactive; section "b" received aqueous and organic waste from 236-Z and 242-Z Buildings.
10/67	10/67	216-Z-1 and 216-Z-2 cribs received 236-Z and 242-Z Building wastes and the discharge point in the tile field was moved 23 m farther down the main trunk from the "b" section to the "c" section.
10/67	3/68	216-Z-1 and 216-Z-2 cribs were inactive. Received 236-Z and 242-Z Building wastes.
3/68	4/69	Continued to receive the above wastes; 216-Z-1 and 216-Z-2 cribs received uranium wastes from 236-Z Building.
4/69		All portions of the 216-Z-1, 216-Z-2, 216-Z-3 cribs and 216-Z-1A tile field retired.

Table 3.2 lists the inventory of what is known to have been disposed to the tile field. All information in the table is from DOE (1992). The two major waste streams to the tile field were 1) process waste and analytical and development laboratory waste from the Plutonium Finishing Plant and 2) aqueous and organic wastes from the Plutonium Reclamation Facility. The early discharged process waste and analytical and laboratory waste were dilute, basic, aqueous solutions, whereas the wastes from the Plutonium Reclamation Facility were acidic, concentrated solutions of nitrates with a pH of 1.0. Periodic small batches of organic wastes containing carbon tetrachloride and tributylphosphate were also disposed to the tile field (Price et al. 1979).

### 3.3.2 216-Z-9 Trench

Construction details for the 216-Z-9 trench are shown in Figure 3.6. The trench is located ~213 m east of the 234-5Z Building and 152 m south of 19th Street in the 200 West Area (see Figure 3.4). The trench consists of a 6.4-m-deep excavation with a 36.6- by 22.5-m concrete cover over what was an active

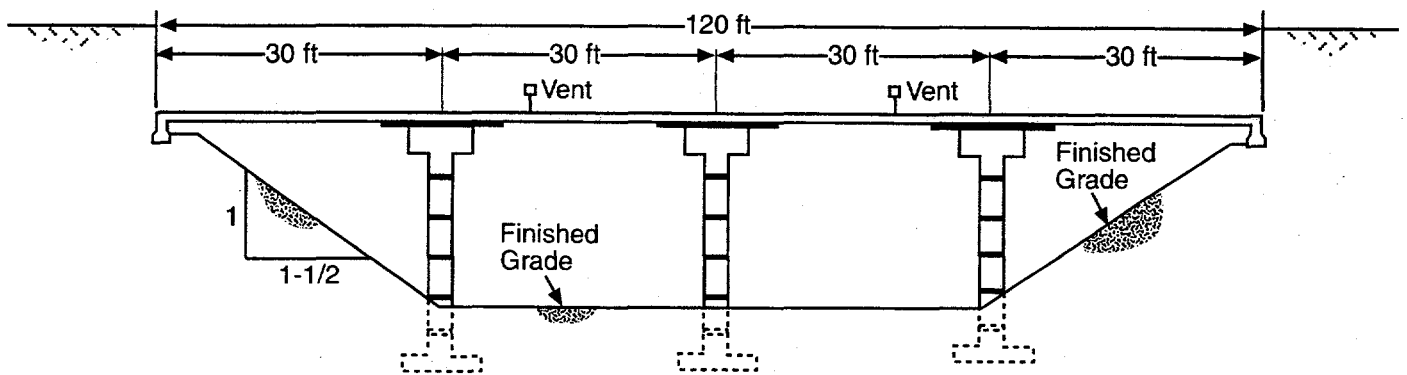
**Table 3.2. Waste Inventories for the Monitored Facilities<sup>(a)</sup> (from DOE 1992)**

	216-Z-1A Tile Field	216-Z-9 Trench	216-Z-12 Crib
Pu (gm)	57,000	48,000	25,000
<sup>238</sup> U		0.000037	0.000017
<sup>137</sup> Cs	0.16	0.052	0.053
<sup>106</sup> Ru	0.0000052	0.000000019	0.00000093
<sup>87</sup> Sr	0.15	0.049	0.051
<sup>60</sup> Co		0.00395	0.00515
<sup>241</sup> Am	3,432	8,580	
<sup>239</sup> Pu	137	2.19	1.43
<sup>240</sup> Pu	37	590	386
CCl <sub>4</sub>	268,000	131,140 to 471,000	
Tributylphosphate	30,000		
DBBP	20,300		
Nitrate	3,000	500,000	900,000
Sodium	900	200,000	600,000
Fluoride	900		300,000
Ca(NO <sub>3</sub> ) <sub>2</sub>		130,000	
Mg(NO <sub>3</sub> ) <sub>2</sub>		180,000	
Nitric acid		39,000	
AlF(NO <sub>3</sub> ) <sub>2</sub>		210,000	
Al(NO <sub>3</sub> ) <sub>3</sub>		190,000	
Fe(NO <sub>3</sub> ) <sub>3</sub>		40,000	
Sulfate		10,000	

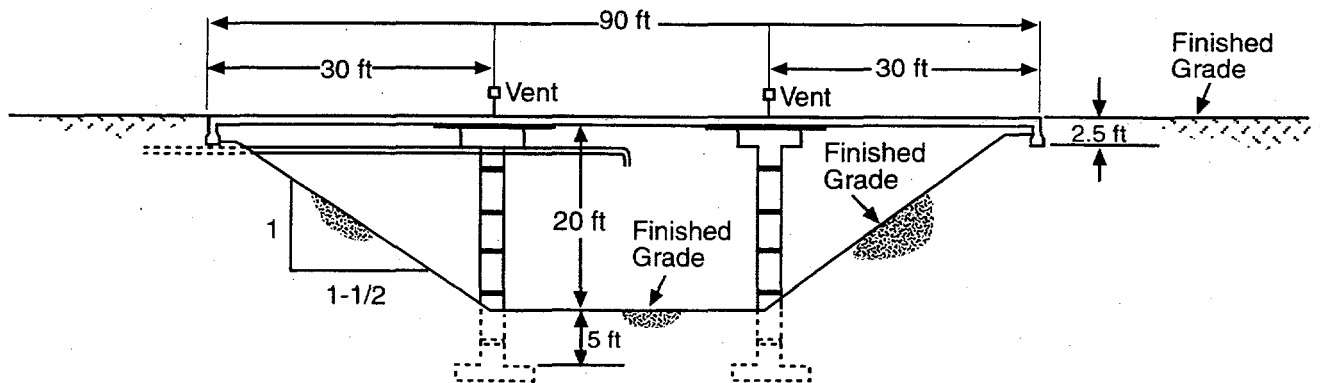
(a) All radionuclide quantities are reported in curies unless otherwise noted. Curies are decayed through 1989. Chemical quantities are reported in kilograms unless otherwise noted.

floor area of 9.1 by 18.3 m (Ridgway et al. 1971). The 23-cm-thick concrete slab cover is supported by 6 concrete columns. The trench remains an open excavation beneath the slab.

The trench operated from July 1955 to June 1962, receiving solvent and aqueous wastes from the RECUPLEX facility in the 234-5Z Building. The trench reportedly received 4,040,000 L of acidic, aqueous, and organic liquid waste from the RECUPLEX facility. In 1973, it was decided to remove plutonium from the trench so as to reduce the risk of environmental contamination and reduce the



NORTH - SOUTH CROSS SECTION



EAST - WEST CROSS SECTION

RP980700049.18

**Figure 3.6.** Construction Details for the 216-Z-9 Trench (after Ridgway et al. 1971)

criticality potential. Between August 1976 and January 1977, the top 30 cm of soil, containing an estimated 58 kg of plutonium, were removed with remote mechanical equipment (Rohay et al. 1994, DOE 1992).

The trench essentially received the same type of waste as the 216-Z-1A tile field: high salt, acidic, aqueous, and organic liquid waste. Kasper (1982) describes the waste as 5M to 6M, acidic (pH ~1.0), sodium nitrate solution. Organic liquids consisted of carbon tetrachloride ( $\text{CCl}_4$ ), tributylphosphate, and dibutylbutylphosphonate (DBBP) as both saturation amounts in the aqueous phase and as separately discharged nonaqueous batches.

### 3.3.3 216-Z-12 Crib

The 216-Z-12 crib is ~122 m southwest of the 234-5Z Building in the 200 West Area (see Figure 3.4). It was constructed in 1958 to replace the 216-Z-3 crib. Having a surface dimension of 25 by 110 m, the crib was excavated to 6.1 m deep. The crib has inward sloping sides, resulting in a 6.1- by 91.4-m floor dimension (Kasper 1982). The bottom of the crib was covered with 0.6 to 1.2 m (inconsistent information in the literature) of clean gravel. A single, 30-cm-dia., vitreous clay, distribution pipe was placed on the gravel layer with no slope. Forty centimeters of gravel were laid over the pipe, followed by a 0.05-cm polyethylene sheet. The excavation was backfilled to grade (Kasper 1982). Figure 3.7 shows the crib construction details.

The crib was active between 1959 and 1975 and received ~2,810,000 L of process waste and analytical and development laboratory waste from the 234-5Z Building via the 241-Z-361 settling tank. In 1987, a portion of the crib was used as a demonstration for large-scale in situ vitrification. It was noted in J. L. Buel's unpublished letter report that the test resulted in vitrification of the upper 5 m of the crib and, therefore, did not encompass most of the contamination.

Wastes disposed to this crib differed from those sent to the 216-Z-1A and 216-Z-9 facilities; low salt, aqueous phases that were typically dilute (~0.15M), adjusted to be slightly basic (pH ~8), sodium, fluoride, and nitrate solutions (Kasper 1982). Also, the plutonium finishing process did not use organic extraction so that the large amounts of organic-radionuclide complexes disposed to the 216-Z-1A and 216-Z-9 facilities were not disposed to the crib. Kasper (1982) stated that the crib did receive minor amounts of  $\text{CCl}_4$  as part of laboratory waste. Indeed, there is sufficient  $\text{CCl}_4$  associated with the crib to include it in the  $\text{CCl}_4$  soil vapor extraction project.

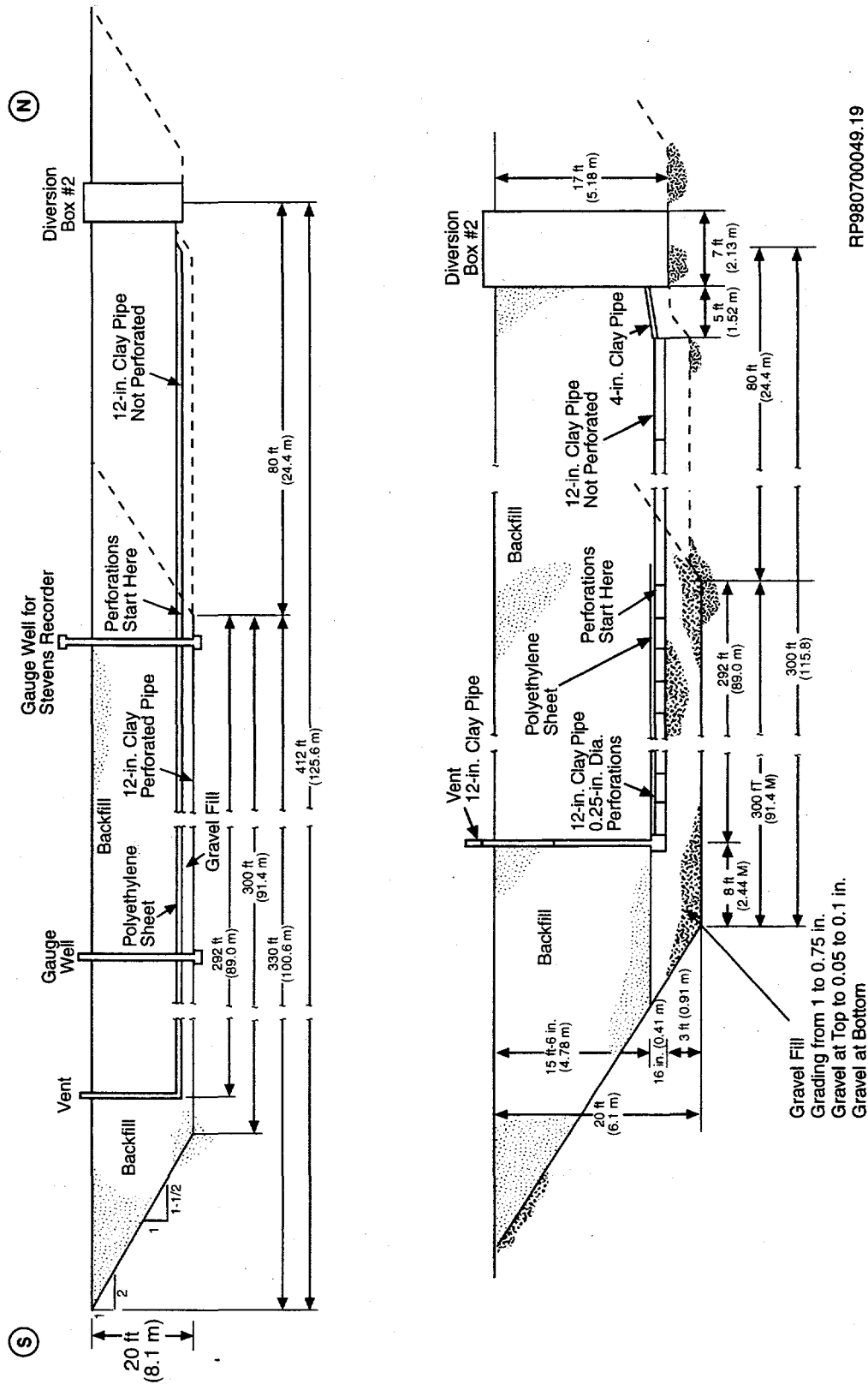


Figure 3.7. Construction Details for the 216-Z-12 Crib (after Kasper 1982)

## 4.0 Methods

### 4.1 Boreholes

Forty-seven boreholes were screened to evaluate their use for spectral gamma-ray logging at the 216-Z-1A tile field, 216-Z-9 trench, and 216-Z-12 crib. The boreholes were chosen based on 1) their location relative to the facility, 2) their location relative to existing subsurface contamination, 3) the availability of historical gamma-ray spectra and laboratory data for baseline purposes, and 4) a superficial evaluation of the borehole construction.

The boreholes were then evaluated for logging quality by reviewing information found in driller's logs, borehole construction reports, as-builts, and documentation of alterations made to the boreholes subsequent to their original construction. Based on the results of these evaluations, 21 boreholes were selected for logging (Table 4.1). The locations of the boreholes relative to the facilities are shown in Figures 4.1, 4.2, and 4.3. Twenty-six boreholes were rejected because of unknown construction characteristics, such as annular seals and/or the number of borehole casings, which would render the logging results unquantifiable. Available well construction and summary reports are given in Appendix B of Horton (1998) for boreholes that were logged during this effort.

Except for borehole 299-W18-149, all logged boreholes are 6- or 8-in.-dia., carbon steel cased. Borehole 299-W18-149 is cased with 6-in.-dia. polyvinyl chloride.

Prior to logging, the boreholes were temporarily transferred from the custody of the Bechtel Hanford, Inc. soil vapor extraction operation to Pacific Northwest National Laboratory. Thirteen of the boreholes are used by the soil vapor extraction operation, and the boreholes have special caps designed for CCl<sub>4</sub> vapor extraction. The caps were removed prior to logging but were reinstalled afterward.

Several of the boreholes had not been entered for several years and were swabbed to check for internal contamination. Two were alpha contaminated (299-W18-173 and 299-W18-175). Borehole 299-W18-152 on the west side of the 216-Z-1A tile field had a packer that was removed prior to logging but was replaced after logging. Borehole 299-W18-156 is located directly underneath the outer Plutonium Finishing Plant security fence, making insertion of the logging tool difficult.

### 4.2 Logging Methods

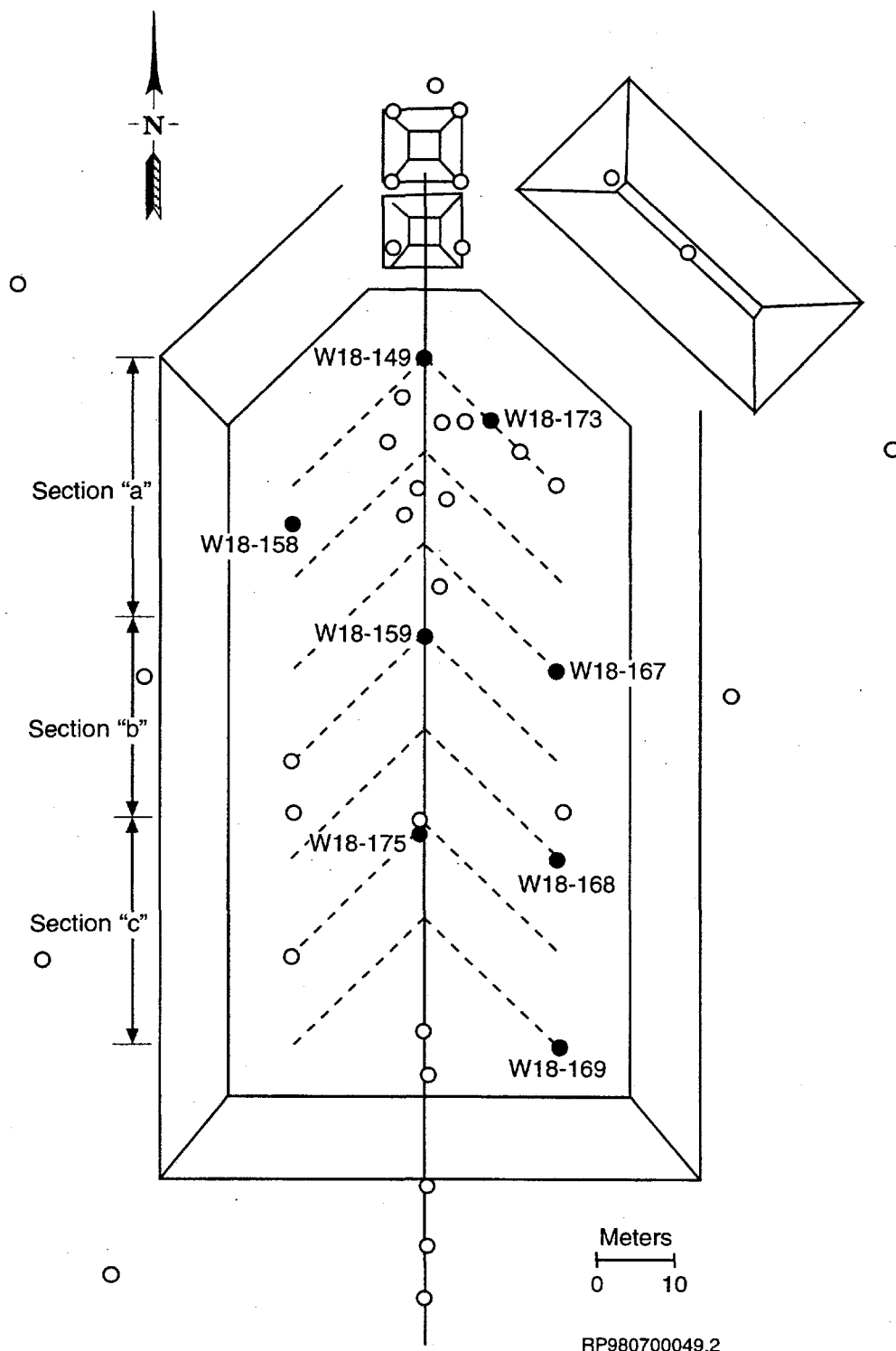
High-resolution gamma spectroscopic instrumentation was used to log the boreholes. The instrument was lowered by an automated hoist controlled by the data acquisition computer system housed in the logging truck. The instrument was centered in the borehole by a centralizer if the borehole casing was >4 in. in diameter. The data collection procedures are described in WMNW (1998).

**Table 4.1. Boreholes Logged at Plutonium Finishing Plant Liquid Waste Disposal Facilities**

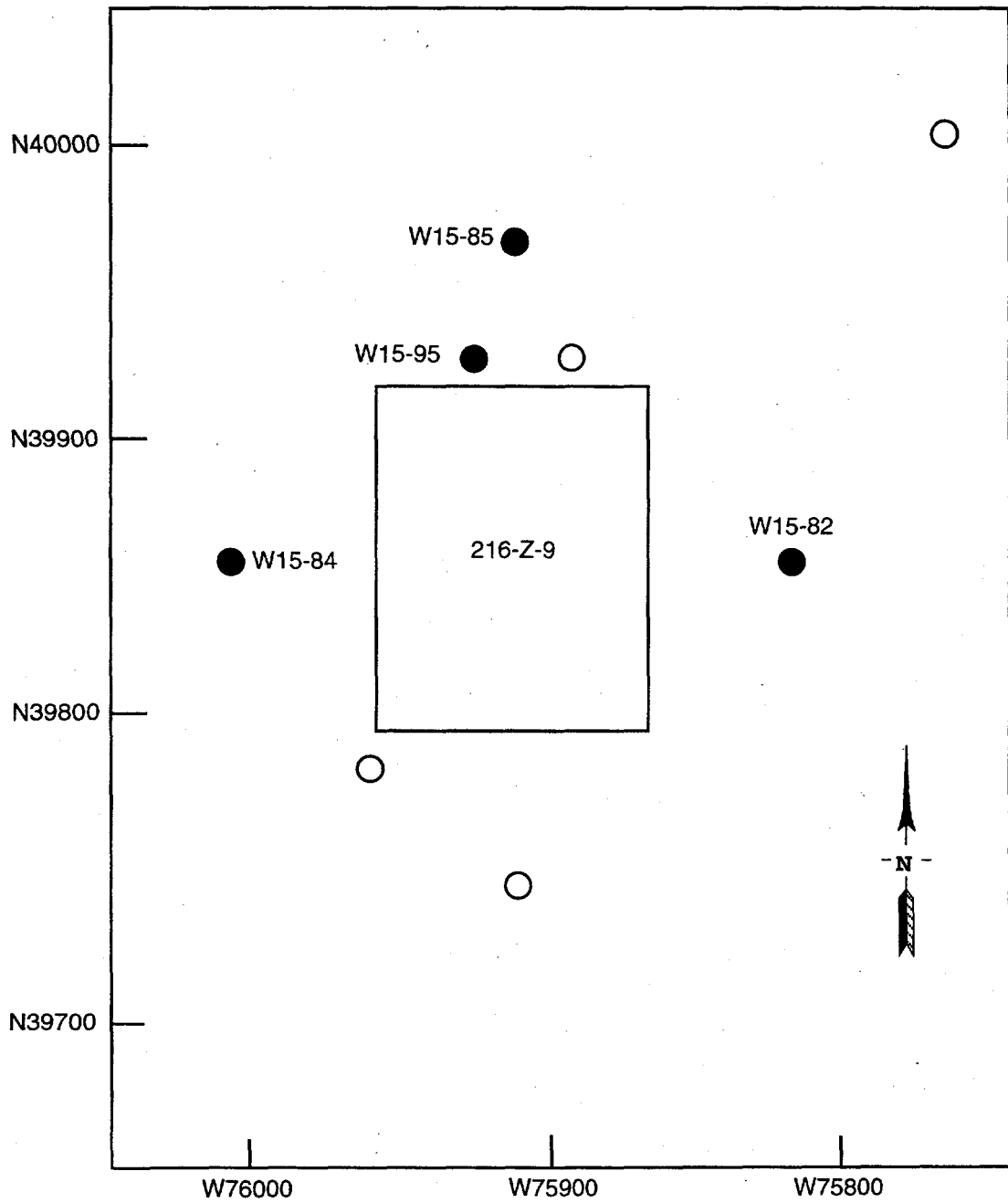
Borehole Number	Date Drilled	Total Depth (ft)	Logged Depths (ft)	Comments
216-Z-1A Tile Field				
299-W18-149	1974	92	0 to 26	Borehole has 6-in. polyvinyl chloride casing; sampled by Price et al. (1979) during drilling; logged with spectral gamma system and with prompt fission neutron (PFN) system in 1993.
299-W18-158	1976	128	0 to 128	Borehole is used for vapor extraction; packer was temporarily removed; sampled by Price et al. (1979) during drilling.
299-W18-159	1977	120	0 to 120	Borehole is used for vapor extraction; sampled by Price et al. (1979) during drilling; logged by spectral gamma-ray system in 1991; logged with PFN system in 1978, 1984, and 1993.
299-W18-167	1977	126	10 to 126	Borehole is used for vapor extraction; sampled by Price et al. (1979) during drilling.
299-W18-168	1977	124	0 to 124	Borehole is used for vapor extraction; sampled by Price et al. (1979) during drilling.
299-W18-169	1977	125	0 to 125	Borehole is used for vapor extraction; sampled by Price et al. (1979) during drilling; logged by spectral gamma system in 1993.
299-W18-173	1977	44	0 to 43	Borehole was sampled by Price et al. (1979) during drilling; logged by spectral gamma system in 1993.
299-W18-175	1977	118	0 to 118	Borehole is used for vapor extraction; logged with spectral gamma-ray and PFN systems in 1993.
216-Z-9 Trench				
299-W15-82	1954	101	0 to 101	Borehole is used for vapor extraction.
299-W15-84	1954	110	0 to 110	Borehole is used for vapor extraction; logged with spectral gamma system in 1992.
299-W15-85	1954	106	0 to 106	Borehole is used for vapor extraction.
299-W15-95	1959	100	0 to 100	Borehole is used for vapor extraction.

Table 4.1. (contd)

Borehole Number	Date Drilled	Total Depth (ft)	Logged Depths (ft)	Comments
216-Z-12 Crib				
299-W18-08	1966	212	0 to 48.5	Borehole was logged with spectral gamma system in 1993.
299-W18-152	1976	118	0 to 118	Borehole is used for vapor extraction; sampled by Kasper (1982) during drilling; logged with spectral gamma system in 1993.
299-W18-153	1976	110	0 to 107	Borehole is used for vapor extraction; sampled by Kasper (1982) during drilling.
299-W18-156	1976	25	0 to 24	Borehole is under the Plutonium Finishing Plant security fence.
299-W18-179	1980	42	0 to 39.5	Borehole was logged with spectral gamma system in 1993.
299-W18-181	1980	137	0 to 137	Borehole was sampled by Kasper (1982) during drilling; logged with spectral gamma system in 1993.
299-W18-182	1980	41	0 to 40	Borehole was sampled by Kasper (1982) during drilling; logged with spectral gamma and PFN systems in 1993.
299-W18-183	1980	38	0 to 38	Borehole was sampled by Kasper (1982) during drilling; logged with spectral gamma system in 1993.
299-W18-185	1980	42	0 to 39	Borehole was sampled by Kasper (1982) during drilling; logged with spectral gamma system in 1993.

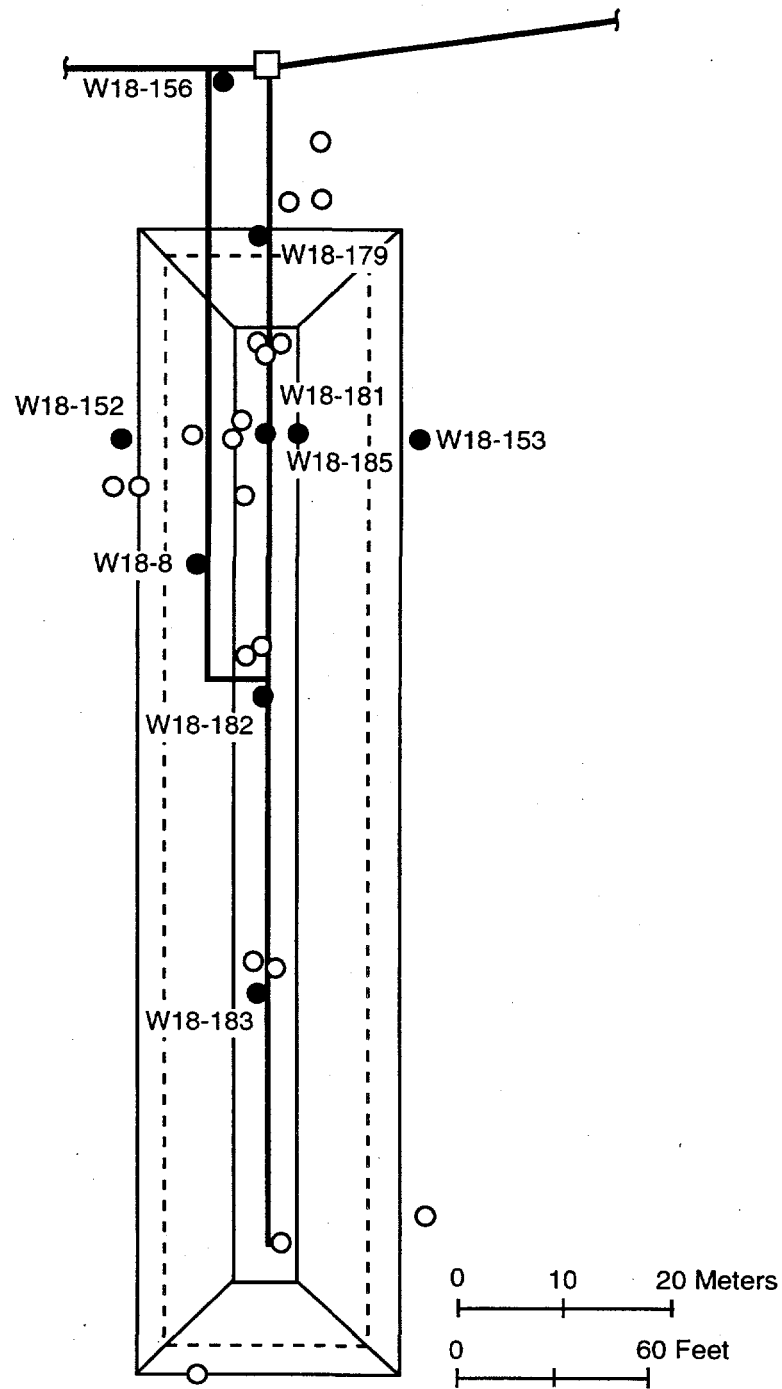


**Figure 4.1.** Borehole Locations at the 216-Z-1A Tile Field. Boreholes represented by solid circles were logged in 1998 (after Price et al. 1979)



RP980700049.3

**Figure 4.2.** Borehole Locations at the 216-Z-9 Trench. Boreholes represented by solid circles were logged in 1998 (after Fecht et al. 1977)



RP980700049.4

**Figure 4.3.** Borehole Locations at the 216-Z-12 Crib. Boreholes represented by solid circles were logged in 1998 (after Kasper 1982)

Data were acquired with a 35% high-purity germanium (HPGe) detector. The detector was liquid nitrogen cooled, and the gaseous nitrogen was vented through a tube in the logging cable. Signals from the detector were amplified in the logging tool and transmitted by cable to the data acquisition computer in the logging truck. A multichannel analyzer accepted signals from the detector within the energy range 0 to 3 MeV. Dead-time corrections adjusted counting times for losses in high count-rate conditions (Koizumi et al. 1994).

Logging speeds were controlled by the data acquisition computer. An optimization of the time required to collect log data versus the time required to achieve the best (lowest) minimum detection levels was used for the boreholes deeper than 50 ft. Boreholes of 50 ft or less in total depth were logged at 6-in. increments for 200 s per depth reading. Boreholes over 50 ft total depth were first logged at 6-in. increments for 47 s per depth reading. Full analysis of the first log data set was used to determine a re-log section of most critical depths. The goal was to cover the deepest possible indications of a contaminant with a longer sample time of 200 s/6-in. increment.

Data analysis methods have been described by Stromswold (1994a), who performed a technical review of the software. Briefly, the analysis software reads the spectral data and analyzes the spectrum to locate peak centroids, performs a background subtraction, determines a peak count rate, and calculates a statistical uncertainty in the count rate. Absolute photo peak intensities are used to determine the calibration coefficients. In cases where daughter products are used to identify the parent, branching ratios are applied to the calibration coefficient during the analysis process. Radionuclides are then identified based on peak energy, and the peak areas are corrected for attenuation of gamma rays by steel casing (Koizumi et al. 1991). Casing thicknesses were measured in the field by caliper. Finally, concentrations are calculated using peak areas and gamma-ray emission properties. For radionuclides with multiple peaks, the "best result" was determined from the statistical uncertainty of each peak (Stromswold 1994a). In addition, all channels (energies) were summed to obtain a gross gamma-ray spectrum.

#### **4.2.1 System Calibration**

The collection of the spectral data required the calibration of the instrumentation. Two calibrations are applicable: 1) a depth calibration of the cable and cable hoist system and 2) a calibration of the detector and associated electronics.

Depth calibration of the logging system cable hoist was performed by the equipment manufacturer (Greenspan, Inc., Houston, Texas) as part of the system assembly and checkout. The depth encoding sheave wheel generates 2,500 pulses per revolution and has a 14-in. dia. This results in a depth precision of 0.0073 ft per pulse (Section 17.0, Attachment B in WMNW 1998). The accuracy is a function of the weight of the logging probe, the amount of cable in the borehole, and the logging medium (air or water). A depth recalibration is required after system components are subjected to major repairs or alterations. The depth calibration in effect at the time of this logging was performed by Three Rivers Scientific, West Richland, Washington, in March 1998. The depth variance at that time was 0.6-in. root mean square error over 250 ft down and back to surface for an air-filled borehole.

Calibration of the HPGe logging system is required once each year. The calibration in effect at the time these data were taken was done in September 1997. Calibration measurements are made in the calibration facilities at the Hanford Site. The Hanford Site calibration models were built and assayed by the U.S. Department of Energy's Grand Junction Projects Office (Heistand and Novak 1984) and are traceable to the gamma-ray counting standards certified by the U.S. Department of Energy's New Brunswick Laboratory, Argonne, Illinois. The calibration standards and their construction are described by Stromswold (1994b). The analysis of the calibration data and the resulting calibration factors are described by Randall (1994).

#### **4.2.2 Pre-Log and Post-Log Energy Calibration/Verification**

Energy calibration was performed on location at the borehole site just prior to log data collection. The linear energy conversion from channels was established using two characteristic gamma rays from a  $^{232}\text{Th}$  source, placed directly over the detector section of the logging instrument. The measurement was made with either a Coleman<sup>®</sup> mantle assembly or a potassium-uranium-thorium unit from Amersham International PLC (Amersham, United Kingdom).

An instrument verification was also performed prior to and after each logging event. Because there is no photo peak interference at the 583-keV gamma ray from the  $^{232}\text{Th}$  source, that photo peak was used to perform both the pre-log and post-log instrument verification. The instrument verification was established by measurement of the full width at half maximum of this characteristic gamma ray emitted from the  $^{232}\text{Th}$  and observed in the collected spectra. The same spectra collected to perform the photo peak energy calibration was used to analyze the full width at half maximum of the 583-keV photo peak. The acceptance criteria for the pre- and post-logging energy resolution as determined by the full width at half maximum was 1.5 times the value established during maintenance (3 keV) (Section 17.0, Attachment D in WMNW 1998). For all logging passes, the pre- and post-logging instrument verification was within specifications.

#### **4.2.3 Repeat Logs**

A quality assurance/quality control requirement for spectral gamma-ray logging is collection of a repeat log section. The logging procedures dictate that the repeat log interval shall be 10 ft or 10% of total borehole depth, whichever is smaller. The repeat log was collected after the borehole was logged over the entire depth open to the instrument. A gross gamma-ray calculation was generated for the main pass log data and, from this signature, the repeat depth interval was selected. The goal was to repeat the deepest section of contamination. Good agreement was obtained between the main log and the repeat log in every case.

Deviations in the log data, the main log, and repeat log (and the re-log sections when applicable) were within standard statistical limits except for uranium and gross gamma in boreholes where radon pumping was observed (Section 4.3, item 4). Each analysis package for each borehole contained plots of the repeat sections, with the statistical error displayed as error bars. Those plots are included in the Appendix.

### 4.3 Data Interpretation

Logging data were plotted as concentration versus depth for each spectrum. These plots were compared to lithologic columns drawn to the same scale to idealize geologic control over contaminant distribution. Lithologic information was taken from geologist's logs, if available, driller's logs, well construction and completion summaries (if no logs were available), and from published stratigraphy (Price et al. 1979, Kasper 1982). Inconsistencies among sources of lithologic information were common, and data from the geologist's logs were used in those instances.

One of the major difficulties in comparing the log data with lithology was ensuring that the drilling depths, the sampled depths, and the depths recorded by the logging systems were all relative to a common datum. Logging data were corrected to surface elevation before making any comparisons. In several cases, discrepancies in top-of-casing elevation exist. In addition, modifications such as shortening the top of the casing have been made to some of the boreholes since they were drilled. Also, the surface of the 216-Z-1A tile field was modified in the early 1990s by adding ~30 cm of gravel to the surface. These changes, along with inconsistencies in geologist's and driller's logs, make some depth determinations difficult.

Comparison of 1998 logging data to borehole logs collected previously were performed for the boreholes that had previously been logged with the radionuclide logging system. The previous logging data, collected in 1991 and 1993, were obtained and reprocessed consistent with the processing of the 1998 logging data. Also, data from Price et al. (1979) for the 216-Z-1A tile field and data from Kasper (1982) for the 216-Z-12 crib were compared with the new log data. Interpretations of contaminant redistribution were based on changes among the data sets. Several challenges existed in making these interpretations.

Several computations and corrections were necessary to make comparisons between current log data and previously collected log data. These include the following:

1. Depth shift – The depth reference was ground surface for log data collected in 1991 and 1993. The 1998 log data were collected using the top of the casing as the zero-depth reference. Additionally, modifications made to the top of the casings and contamination stabilization may have altered the top of the casing or ground elevation since the last logging event. To place both spectra relative to the same elevation datum, the gross gamma spectra from past logging events were depth adjusted to get the best fit with the new log data.
2. Dead-time correction limitations – Previous log data were recorded using an earlier version of electronic signal processing. The 1993 log data had a limit for dead-time correction at 20% dead time and below. The 1998 log data have a limit of 32% and below for dead-time corrections.
3. Raw data reanalysis – To make rigorous comparisons of old and current data, the raw spectral data of the previous logs were reanalyzed with the same casing corrections and radionuclides as the current (1998) log data analysis.

4. Gross gamma-ray comparisons – Different amounts of radon from atmospheric pumping occur during different days of log data collection. The changes in radon levels within the borehole cause the gross gamma-ray count rate to change. This occurred during collection of some of the 1998 log data between the time the main log and the re-log were acquired, as well as between the 1993 and 1998 data acquisition.
5. Statistical precision – Apparent but not real changes in radionuclide abundances are possible for very low gamma-ray intensities because of the statistical precision of both the current and past log data sets.
6. Depth coefficients – Different logging units can have slight systematic errors in absolute depth. At extended depth intervals, the systematic depth errors can be significant. A depth stretch, or shrinkage, can be used to correct for this type of difference and make log-to-log comparisons. Given that possible depth changes in a contaminant can also be viewed as a depth stretch, no such corrections were applied during analysis.
7. Natural decay – Any given radionuclide has an inherent decay with a specific decay rate.  $^{137}\text{Cs}$  is the only radionuclide detected during 1998 logging that has any significant change in activity because of natural decay since previous log data were collected.
8. Depth sampling – Different sample points for different logging runs can result in apparent but not real differences in observed maximum readings from thin zones or highly structured beds. Grade-thickness products were used for thin zones to eliminate the effect of different sampling points for different log runs.
9. Photo peak interference – The interference of multiple photo peaks in the near (energy) vicinity of a photo peak of interest can be stripped from the spectra with suitable peak area computations. This correction for interference was not made for the current work.

There also are several issues to consider when comparing log data with data from laboratory-analyzed core samples.

1. The volume of a core sample is typically 100 to 200 times less than the volume investigated by the logging system. Heterogeneity of contaminant distribution over the representative volume plays a large role in the results.
2. Vertical depth accuracy and vertical resolution can be widely different in logging and coring operations. Log-depth control is generally very accurate, but operations and equipment can have consistent errors.
3. Contaminants confined to thin intervals may be completely missed during core or chip sampling. Logging data will average the thin interval with the bounding units.

4. The collection, preparation, and analysis of a sample in the laboratory may interject some bias relative to log data. For example, exclusion of coarse-grained granules, pebbles, and cobbles from the laboratory samples may concentrate a contaminant relative to the log analysis.
5. Laboratory procedures allow one to dilute sediment samples and/or allow counting for longer times such that laboratory practices can detect activity over a greater range than can typical log analysis.

All of the above made the comparison of laboratory-derived data and the log data challenging. In general, the comparisons were not as good as anticipated, so that most inferences as to contaminant movement were made from comparisons with past log data.

## 5.0 Results

The following are descriptions of the spectral gamma-ray logging results for each borehole logged at 216-Z-1A tile field, 216-Z-9 trench, and 216-Z-12 crib. Comparisons are made with past log data and/or previous laboratory data where such data exist. Information on 1998 log results is summarized from a data compilation by K. D. Reynolds, Waste Management Federal Services, Inc. Northwest Operations, Richland, Washington. The log headers, activity-versus-depth profiles, acceptance quality assurance processing spectra, and log analysis summaries with minimum detection limits for each borehole logged are given in the Appendix. It should be noted that, unlike depths reported in this section, the depths in the Appendix are not corrected for casing stickup. Raw spectral data and processed data for all gamma-ray spectra (both 1998 and previous) are available in a Pacific Northwest National Laboratory database.

### 5.1 216-Z-1A Tile Field

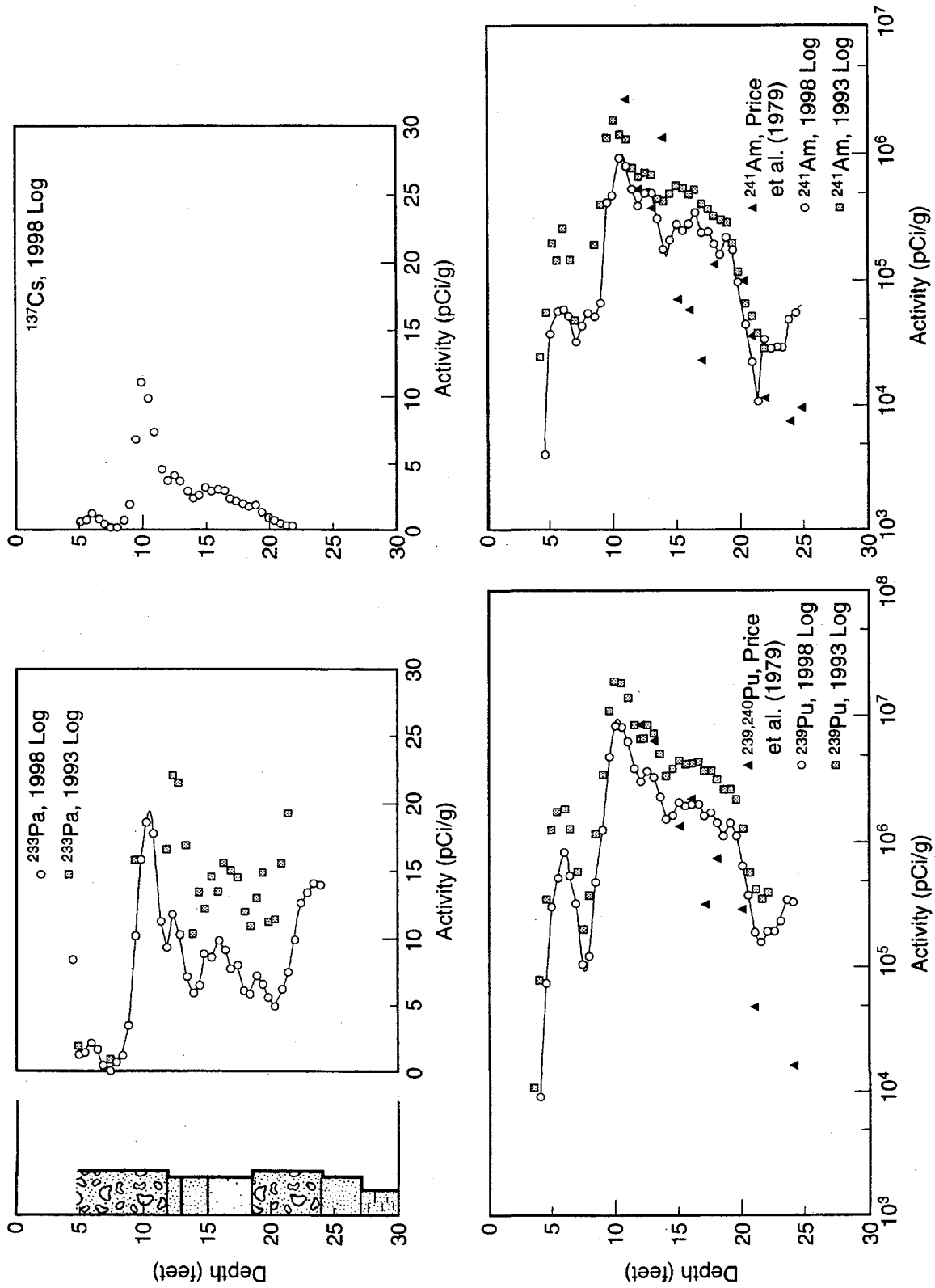
#### 5.1.1 Borehole 299-W18-149

This borehole is located at the head end of the tile field and at the junction of the center distributor pipe and the first set of diagonals. The borehole was drilled in 1974 to a depth of 92 ft and cemented back to 75 ft. However, only 26 ft remain open today. The distributor pipe is at a depth of ~8 ft, and the bottom of the tile field is at ~10 ft at this borehole.

$^{137}\text{Cs}$ ,  $^{233}\text{Pa}$ ,  $^{239}\text{Pu}$ , and  $^{241}\text{Am}$  were identified between 4 and 24 ft. Maximum activity for each radionuclide is at 10 to 10.5 ft (11 pCi/g for  $^{137}\text{Cs}$ , 20 pCi/g for  $^{233}\text{Pa}$ , 8,400 nCi/g for  $^{239}\text{Pu}$ , and 900 nCi/g for  $^{241}\text{Am}$ ), which coincides with the base of the tile field. The system dead-time limits were exceeded between 9 and 12 ft; therefore, activities are higher than reported in this interval. In addition to the man-made radionuclides,  $^{208}\text{Tl}$  was found between 6 and 21 ft in concentrations that are not in secular equilibrium with the other daughter products of  $^{232}\text{Th}$ .

There are two lenses of contamination in the borehole, with the deeper one covering a larger depth interval and much higher concentrations of all observed radionuclides (Figure 5.1). The smaller peak in all intensities occurs at 6 ft. The larger maximum occurs at ~10 ft, with a broadly spreading and declining activity down to 21 ft, where a third rise is observed.

The neutron capture of hydrogen at 2.22 MeV is observed in the 1998 data set from this borehole. Because the hydrogen content from vadose zone moisture is very low, the hydrogen in the polyvinyl chloride casing is most likely the source of these capture events. Given the presence of the thermal neutron-induced hydrogen gamma rays, other neutron- and fission-induced gamma activity is predicted, and the spectra contain many unidentified photo peaks as a result of these nuclear events. Spectra covering 0 to 10 MeV are needed to determine the source of the photo peaks; whereas the present data cover 0 to 3 MeV.



RP980700049.14

**Figure 5.1.** Comparison of Activities Versus Depth from 1993 and 1998 Log and Laboratory Data in Borehole 299-W18-149 (laboratory data from Price et al. 1979)

This borehole was last logged by spectral gamma-ray methods in 1993. At that time  $^{233}\text{Pa}$ ,  $^{239}\text{Pu}$ , and  $^{241}\text{Am}$  were identified between ~4 and 22 ft. Maximum values were between 10 and 11 ft and were 36 pCi/g for  $^{233}\text{Pa}$ , 19,000 nCi/g for  $^{239}\text{Pu}$ , and 1,800 nCi/g for  $^{241}\text{Am}$ .  $^{137}\text{Cs}$  was not reported, but was present as determined by reprocessing of the data.  $^{208}\text{Tl}$ , out of secular equilibrium with other daughter products of  $^{232}\text{Th}$ , was found between 9 and 22 ft.

Any comparison of the 1993 and 1998 log data from this borehole must be restricted to intervals excluding the zone between 9 and 12 ft because of limitations on dead-time correction accuracy of both log data sets. Grade thickness products between 12 to 24 ft showed a 29% increase in  $^{137}\text{Cs}$ , 16% increase in  $^{233}\text{Pa}$ , 11% decrease in  $^{239}\text{Pu}$ , and 17% decrease in  $^{241}\text{Am}$ . For all the radionuclides, the shape of the depth profiles over this interval appears the same in 1998 as in 1993, given the systematic changes in apparent concentrations. This leads to the most likely conclusion that the observed changes are due to interferences and calibration and/or corrections errors.

This borehole was logged with a prompt fission neutron system in 1993 by D. C. George and R. D. Wilson for the U.S. Department of Energy's Grand Junction Projects Office. That logging event identified  $^{239}\text{Pu}$  between 5 and 20 ft, with a maximum of ~16,300 nCi/g at slightly less than 10 ft.

Price et al. (1979) found  $^{239,240}\text{Pu}$  and  $^{241}\text{Am}$  between 11 and 25 ft. At that time, the borehole was open to 95 ft and they found  $^{239}\text{Pu}$  intermittently to 60 ft and  $^{241}\text{Am}$  to 95 ft. All activities at depths >60 ft were <0.1 nCi/g. Figure 5.1 shows a comparison of the 1979 reported laboratory data and the 1998 log data.

### 5.1.2 Borehole 299-W18-158

This borehole is located between the distal ends of the first and second diagonals on the west side of the tile field.

The only man-made radionuclide identified in this borehole is  $^{233}\text{Pa}$  at 45 ft (4 pCi/g) and at 58 ft (11 pCi/g).  $^{208}\text{Tl}$  was identified at 53 ft, where it is not in secular equilibrium with other daughter products of  $^{232}\text{Th}$ . If the  $^{208}\text{Tl}$  is due to waste input of  $^{232}\text{Th}$  into the tile field, then it has been differentiated from  $^{233}\text{Pa}$  because the two radionuclides occur at different depths. The geology log between 52 and 70 ft is missing, so lithologic correlation with radionuclide distribution cannot be made. Also, radon pumping is evident in the repeat section of the log data.

This borehole has not been logged previously, but Price et al. (1979) found  $^{239}\text{Pu}$  (0.037 nCi/g) and  $^{241}\text{Am}$  (0.002 nCi/g) at 50 ft during drilling. These values are well below the minimum detection limits of the current logging.

### 5.1.3 Borehole 299-W18-159

This borehole is located approximately half way down the centerline of the tile field.

$^{137}\text{Cs}$  occurs between 9 and 58 ft, with a maximum activity of 23 pCi/g at 11 ft.  $^{233}\text{Pa}$  was found between 11 and 53 ft, with a maximum activity of 63 pCi/g at 52.5 ft.  $^{239}\text{Pu}$  was identified between 5 and 63 ft, with a maximum activity of 25,000 nCi/g at 11 ft and a second but lesser maximum of 3,683 nCi/g at 43 ft.  $^{241}\text{Am}$  also showed two maxima: one at 13 ft (2,500 nCi/g) and the second at 43 ft (1,293 nCi/g). The system dead-time limits were exceeded between 10 and 15.5 ft, so that activities will be higher than reported in this interval. In addition to these man-made radionuclides,  $^{208}\text{Tl}$  was found between 9 and 65 ft in concentrations that are not in secular equilibrium with other daughter products of  $^{232}\text{Th}$ .  $^{208}\text{Tl}$  exhibits two maxima: one at 28 ft and the second at 46 ft.

Most of the radionuclides identified in this borehole show two maxima: one at the base of the tile field at ~11 ft and the other at ~45 ft. The deeper maximum occurs at a depth approximately equivalent to a gradual transition from coarse sand to underlying fine to medium sand (geology from Price et al. 1979).

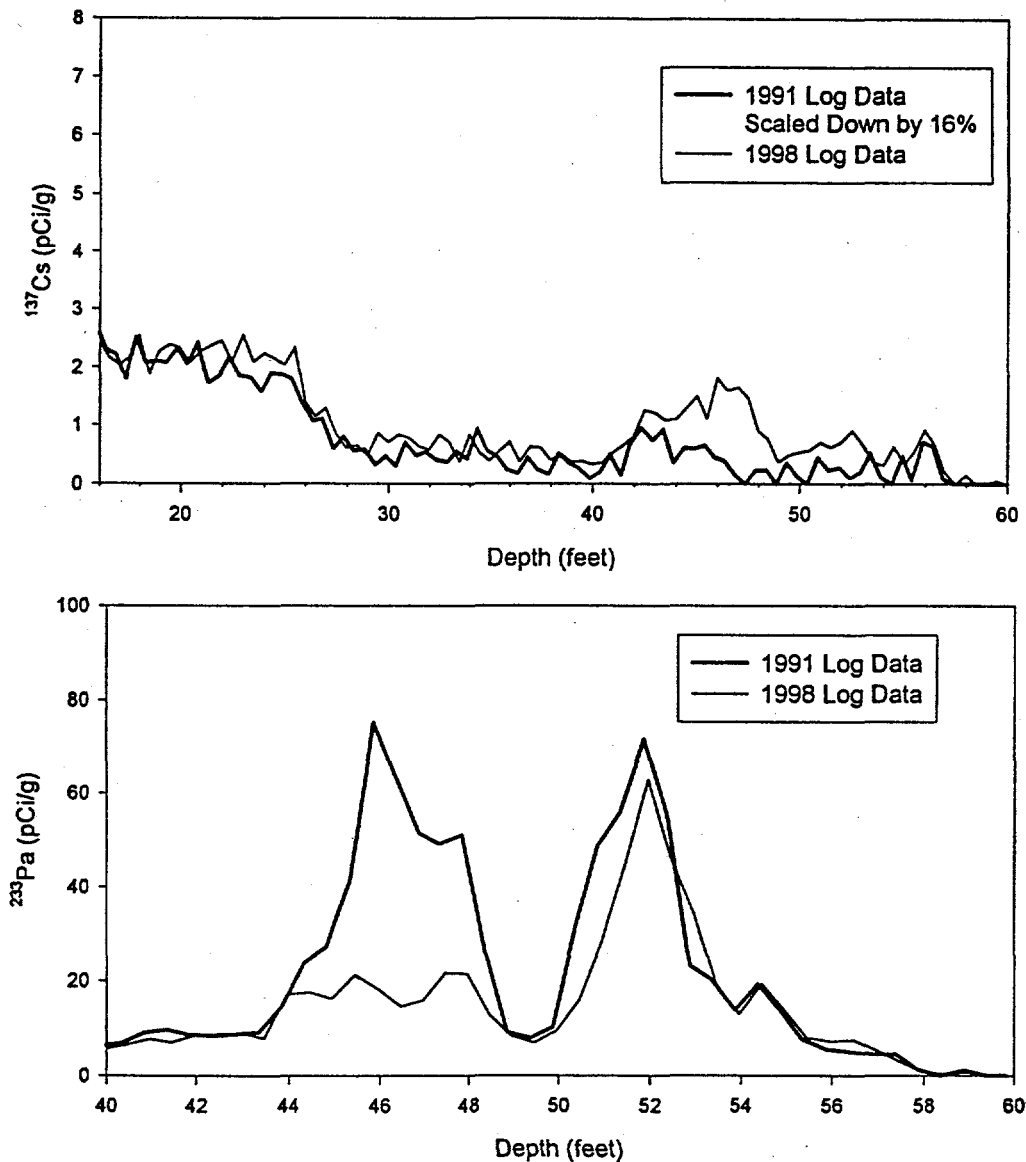
This borehole was last logged by spectral gamma-ray tools in 1991, at which time only  $^{137}\text{Cs}$  and  $^{152}\text{Eu}$  were reported. However, reprocessing of the 1991 spectra shows that  $^{137}\text{Cs}$ ,  $^{233}\text{Pa}$ ,  $^{239}\text{Pu}$ , and  $^{241}\text{Am}$  isotopes were present but not reported.

Any comparisons of the 1991 and 1998 log data must exclude the interval from 5 to 14 ft because high count rates exceed the dead-time accuracy in this interval for both data sets. The comparison of the log data sets over other depth intervals shows changes in  $^{233}\text{Pa}$  activity over the interval 44 to 49 ft, where the activity has decreased to one-third the 1991 levels (Figure 5.2). There is no apparent change in  $^{233}\text{Pa}$  activity above and below 45 to 50 ft, suggesting that the change is lateral and not vertical movement of  $^{233}\text{Pa}$ .

There also appears to be a change in the  $^{137}\text{Cs}$  activity in this borehole (see Figure 5.2).  $^{137}\text{Cs}$  must be corrected for natural decay, and the  $^{137}\text{Cs}$  activity in the older log data was reduced 16% to make a quantitative comparison. As can be seen from the log comparison for  $^{137}\text{Cs}$  over the 17- to 42-ft interval, there is no noticeable difference between the 1991 and 1998 data. However, from 43 to 53 ft, there has been a factor of 3 increase in the summed concentration.

There is no consistent scaling factor that can be applied to the 1998  $^{239}\text{Pu}$  data to match the 1991 distribution. Thus, there is an apparent 7% decrease in  $^{239}\text{Pu}$  over the interval from 17 to 28 ft and no noticeable change in the interval from 28 to 44 ft. No clear conclusion regarding changes in the depth profile of  $^{241}\text{Am}$  can be made because of statistical precision and photo peak interference.

This borehole was logged in 1993 by prompt fission neutron methods and the results are given in a U.S. Department of Energy Grand Junction Projects Office unpublished report. That logging showed that maximum  $^{239}\text{Pu}$  activity was ~80,000 nCi/g at slightly less than 10 ft, the activity decreased and leveled out to ~1,000 nCi/g between 18 and 25 ft, then dropped to ~50 nCi/g before peaking again at 45 ft with ~1,000 nCi/g. This borehole was also logged by prompt fission neutron methods in 1978 and again in 1984. It was concluded in the report that there had been no movement of plutonium at this borehole between 1978 and 1993.



**Figure 5.2.** Comparison of  $^{137}\text{Cs}$  and  $^{233}\text{Pa}$  Activities Versus Depth from 1991 and 1998 Log Data in Borehole 299-W18-159

In sampling this borehole during drilling, Price et al. (1979) found  $^{239,240}\text{Pu}$  intermittently throughout the entire borehole, with a maximum of 1,260 nCi/g at 21 ft.  $^{241}\text{Am}$  was found in all samples, with a maximum of 412 nCi/g at 46 ft. The shallowest sample obtained by Price et al. (1979) was at 11.2 ft, which is slightly below the base of the tile field. Thus, they could have missed the high activity zone logged for the Grand Junction Projects Office. However, current logging results show 25,000 nCi/g of  $^{239}\text{Pu}$  at 11 ft compared to 134 nCi/g in the 11.2-ft sample of Price et al. (1979). Assuming all data are valid, a very steep gradient in plutonium activity is indicated.

#### 5.1.4 Borehole 299-W18-167

This borehole is at the end of the third diagonal on the east side of the tile field. An inspection of the borehole in 1991 was unable to determine the elevation of the survey marker because the borehole had been recapped.

$^{233}\text{Pa}$  (19 pCi/g),  $^{239}\text{Pu}$  (19 nCi/g), and  $^{241}\text{Am}$  (128 nCi/g) were identified in a thin zone at 55 ft in this borehole (Figure 5.3). The driller's log notes that the sand layer at this depth was moist during drilling in 1977.

This borehole has not been logged previously, but Price et al. (1979) sampled the sediment during drilling and found  $^{239,240}\text{Pu}$  (879 nCi/g) and  $^{241}\text{Am}$  (415 nCi/g) in one sample (with activities above their one sigma uncertainties) at 55 ft. The combined results of the Price et al. (1979) and the current logging suggest no movement of plutonium or americium since 1978.

#### 5.1.5 Borehole 299-W18-168

This borehole is located at the end of the fifth diagonal on the east side of the tile field.

Four man-made radionuclides were identified between 47.5 and 64 ft. The radionuclides and their maximum activities are the following:  $^{137}\text{Cs}$  (<1 pCi/g between 51 and 66 ft),  $^{233}\text{Pa}$  (15 pCi/g at 49 ft),  $^{239}\text{Pu}$  (below minimum detection limit between 52 and 64 ft), and  $^{241}\text{Am}$  (70 nCi/g at 49 ft). In addition,  $^{208}\text{Tl}$  was identified between 48 and 62 ft.

This borehole has not been logged previously with high-resolution instrumentation, but Price et al. (1979) found one sample with  $^{239,240}\text{Pu}$  at 58 ft, with a maximum activity of 136 nCi/g, and  $^{241}\text{Am}$  between 48 and 64 ft, with a maximum activity of 194 nCi/g.

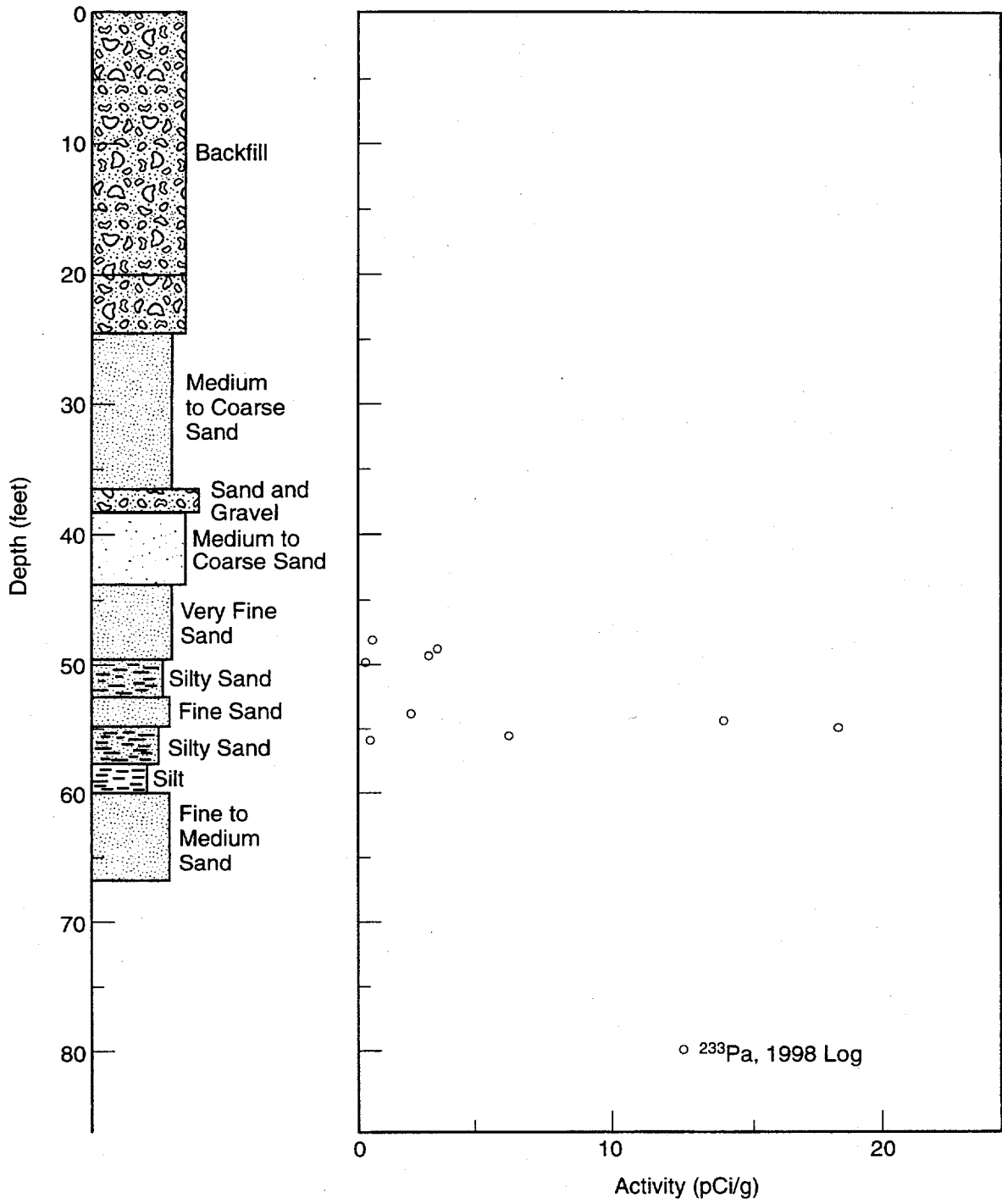
#### 5.1.6 Borehole 299-W18-169

This borehole is on the east side of the tile field at the end of the last diagonal.

No  $^{137}\text{Cs}$  was noted as a result of the 1998 logging.  $^{233}\text{Pa}$  was the only radionuclide identified in this borehole and was found at 35.5 ft, with an activity of 1.3 pCi/g. The borehole was last logged in 1993, at which time  $^{137}\text{Cs}$  was the only man-made radionuclide reported (0.3 pCi/g) and was present in the backfill material between 1.5 and 2 ft.

The 1993 log data were reprocessed and  $^{233}\text{Pa}$  was identified. No observable changes, outside of statistical precision between 1993 and 1998, exist in the  $^{233}\text{Pa}$  distribution. Also, a comparison of the 1993 to the 1998 data shows a radon pumping that appears to increase from the start of the 1998 log data acquisition until approximately the mid point of data collection and then slowly decreases for the remainder of the log data collection.

Price et al. (1979) found  $^{239,240}\text{Pu}$  at ~4.9 nCi/g between 36 and 37 ft during drilling of this borehole.



RP980700049.13

Figure 5.3. <sup>233</sup>Pa Activity Versus Depth in Borehole 299-W18-167

### 5.1.7 Borehole 299-W18-173

This borehole is located half way between the central distributor pipe and the end of the first diagonal on the east side of the tile field.

$^{137}\text{Cs}$  was found at  $<1$  pCi/g between 1 and 4.5, 13 and 14, and 27 and 40 ft.  $^{233}\text{Pa}$  was identified in two zones: one at 11 to 23 ft and the other at 25 to 42 ft, with a maximum of 7 pCi/g at 28.5 ft.  $^{239}\text{Pu}$  and  $^{241}\text{Am}$  were found in three zones between 11.5 and 16, 28 and 30, and 40 and 42 ft. The maximum  $^{239}\text{Pu}$  value is just below the base of the tile field at 13 ft (34 nCi/g); the maximum  $^{241}\text{Am}$  value is at 28.5 ft (80 nCi/g).

The borehole was last logged in 1993, at which time  $^{233}\text{Pa}$  was found between 12 and 21 ft and between 25.5 and 43 ft, with a maximum activity of 7.3 pCi/g at 43 ft.  $^{239}\text{Pu}$  existed between 13 and 15 and 28 and 28.5 ft, with a maximum of 58.9 nCi/g at 13 ft.  $^{241}\text{Am}$  was identified at 13 ft and intermittently between 27.5 and 40.5 ft, with a maximum of 50 nCi/g at 33.5 ft. The distribution and activity of the identified cesium, plutonium, and americium isotopes are comparable in the 1993 and 1998 data, given the statistical precision of both data sets. However,  $^{233}\text{Pa}$  shows a consistent 18% decrease at all depths. Given the similar shapes of the 1993 and 1998 depth profiles, the associated statistical precisions, and the consistent change over all depths, the apparent change in  $^{233}\text{Pa}$  activity is most likely due to calibration or correction errors and not to a change in actual activity. However, horizontal spreading away from the borehole cannot be ruled out.

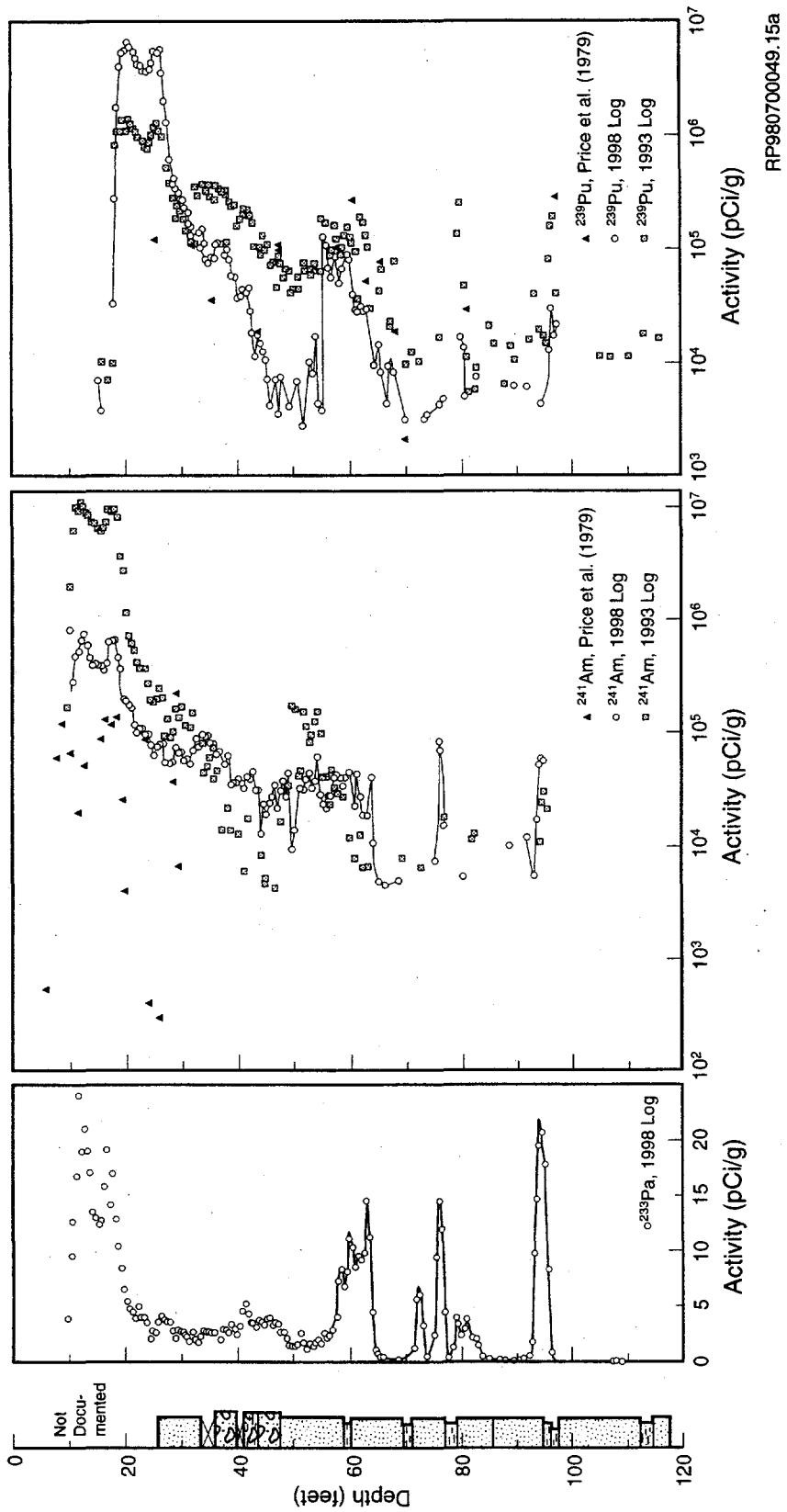
Price et al. (1979) found  $^{239,240}\text{Pu}$  at levels above their minimum detection limits at 16 ft (2.4 nCi/g), 46 ft (50 nCi/g), and 51 ft (5.3 nCi/g). The maximum  $^{241}\text{Am}$  activity was 210 nCi/g at 34 and 46 ft.

### 5.1.8 Borehole 299-W18-175

This borehole is located at the junction of the sixth diagonal with the center distributor pipe. This is at the discharge point for section "c" of the tile field.

The system dead-time limits were exceeded between 10.5 and 13.5 and 17 and 19.5 ft in this borehole.  $^{137}\text{Cs}$  was identified in three zones: 9 to 64, 75 to 77, and 90 to 96 ft. The maximum (8 pCi/g) occurs in the upper zone beneath the base of the tile field at 12 ft. The lower zones coincide with silt units.  $^{233}\text{Pa}$  was found in two zones: 10 to 67 and 72 to 97 ft. The maximum activity was 24 pCi/g at 12.5 ft, corresponding to the base of the tile field. Five other maxima occur at depth and correspond to thin silt beds bounded by sand beds (Figure 5.4).  $^{239}\text{Pu}$  was identified between 10 and 67 and 72 and 97 ft, with a maximum of 6,600 nCi/g at 12.5 ft. As with the distribution of  $^{233}\text{Pa}$ , the  $^{239}\text{Pu}$  distribution may correspond to thin silt units within the sand beds.  $^{241}\text{Am}$  was found between 10 and 64, 75 and 77, and 92 and 95 ft. The maximum value was 800 nCi/g at 14 ft. In addition,  $^{208}\text{Tl}$  was found between 6 and 60 ft, where it is not in secular equilibrium with the other daughter products of  $^{232}\text{Th}$ .

Comparison of the 1993 and 1998 log data lead to several observations. First, the gross gamma-ray response in 1998 shows a dramatic increase over that of the 1993 spectra in a thin zone at 41 ft. The photo peaks used to identify radionuclides cannot account for the observed increase. The photo peak used



**Figure 5.4.** Comparison of  $^{233}\text{Pa}$ ,  $^{241}\text{Am}$ , and  $^{239}\text{Pu}$  Activities Versus Depth from 1993 and 1998 Log and Laboratory Data in Borehole 299-W/18-175 (laboratory data from Price et al. 1979)

for the quantification of  $^{241}\text{Am}$  is the 208-keV gamma ray, and there is no noticeable change in this photo peak from 1993 to 1998. However, there is a dramatic increase in the  $^{241}\text{Am}$  60-keV photo peak between 1993 and 1998. One possible explanation is a change in casing thickness (corrosion?) between 1993 and 1998 that attenuates the lower energy photons less in 1998 than in 1993. Alternatively, a small amount of  $^{241}\text{Am}$  may be on the inside of the casing at this depth.

$^{137}\text{Cs}$ ,  $^{239}\text{Pu}$ , and  $^{241}\text{Am}$  (using the 208-keV photo peak) show an apparent and consistent 10% decrease throughout the entire depth of the borehole. The consistency of this change suggests a calibration or correction error and not a real change in activities.

Finally, a change in  $^{233}\text{Pa}$  activity at specific depth intervals is observed (Figure 5.5). From 20 to 53 ft,  $^{233}\text{Pa}$  increases 51% over the 1993 log results, but shows no change from 53 to 57 ft. Also, there is a significant decrease in  $^{233}\text{Pa}$  for the thin zone at 58 ft and a 22% increase in  $^{233}\text{Pa}$  at the zone from 93 to 97 ft. The conclusion is that the distribution of  $^{233}\text{Pa}$  activity has changed since 1993.

This borehole was also logged by prompt fission neutron methods in 1993 for the U.S. Department of Energy's Grand Junction Projects Office. Those results and the results of 1978 and 1984 prompt fission neutron logs from the same borehole lead to the conclusion that there was no change in the distribution of  $^{239}\text{Pu}$  between 1978 and 1993.

Price et al. (1979) identified  $^{239,240}\text{Pu}$  between 17 and 29, 37 and 64, at 77, and at 95 ft. They also identified  $^{241}\text{Am}$  from 17 ft to the bottom of the borehole.

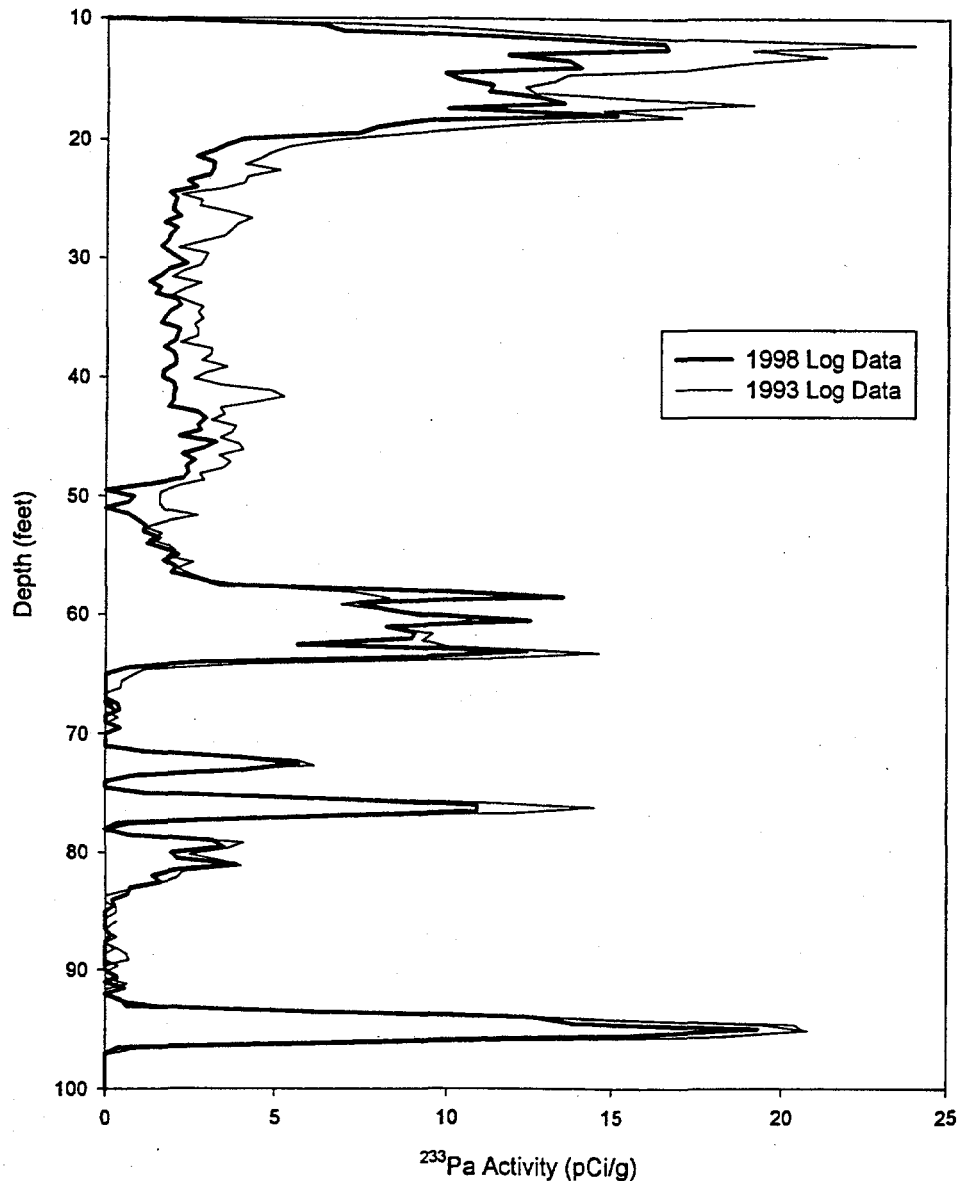
## 5.2 216-Z-9 Trench

Four boreholes were logged around this trench: 299-W15-82, 299-W15-84, 299-W-15-85, and 299-W15-95. The only man-made radionuclide identified was  $^{137}\text{Cs}$  in borehole 299-W15-95. The  $^{137}\text{Cs}$  was identified at the surface and at an activity of <1 pCi/g. Borehole 299-W15-84 was logged by spectral gamma-ray methods in 1992. No man-made radionuclides were identified as a result of that logging. Fecht et al. (1977) found gamma activity in two boreholes (299-W15-8 and 299-W15-86) at 50 and 125 ft, but found near-background levels in boreholes 299-W15-82, 299-W15-84, and 299-W15-85. They did not log borehole 299-W15-95.

## 5.3 216-Z-12 Crib

### 5.3.1 Borehole 299-W18-08

This borehole is located ~33 m south of the head end of the crib, near the center of the crib, and adjacent to the 1968 distribution pipe. The borehole was drilled in 1966 to a depth of 212 ft but is only open to 48.5 ft today.



**Figure 5.5.** Comparison of  $^{233}\text{Pa}$  Activity Versus Depth from 1998 and 1993 Log Data in Borehole 299-W18-175

$^{233}\text{Pa}$  and  $^{239}\text{Pu}$  were identified from the gamma-ray log.  $^{233}\text{Pa}$  occurs between 24 and 36 ft, with a maximum activity of 57 pCi/g at 24.5 ft, and  $^{239}\text{Pu}$  occurs between 24 and 28 ft, with a maximum of 58 nCi/g at 24.5 ft. This borehole was last logged in 1993. Only  $^{233}\text{Pa}$  was reported at that time. Reprocessing of the raw spectral data from 1993 showed that  $^{239}\text{Pu}$  was present but not reported. There is an apparent 5% increase in  $^{233}\text{Pa}$  since 1993, but the activity-versus-depth profiles are the same. This indicates that a scale factor change has resulted from calibration or from environmental correction differences between the 1993 and 1998 systems, and thus, no real change in the activity of  $^{233}\text{Pa}$  exists. Poor statistical precision associated with the 1993  $^{239}\text{Pu}$  log data prohibits comparisons for that radionuclide.

An increase in the gross gamma-ray intensity over what is normally found in Hanford Site soils at 24 ft was noted in both the 1998 and 1993 logs. The increase is attributed to  $^{208}\text{Tl}$ , a daughter of natural  $^{232}\text{Th}$ . The  $^{208}\text{Tl}$  is not in secular equilibrium with the other radionuclides in the  $^{232}\text{Th}$  decay chain.

### 5.3.2 Borehole 299-W18-152

This borehole is located just west of the crib approximately one-quarter the way down the length of the crib.

$^{233}\text{Pa}$  between 22 and 27 ft was the only man-made radionuclide identified. The maximum value was 16 pCi/g at 23.75 ft. The borehole was previously logged in 1993, at which time  $^{233}\text{Pa}$  was identified at the same depth interval (22.5 to 26.5 ft) and with the same maximum activity (17 pCi/g at 23.5 ft). Thus, there has been no change in  $^{233}\text{Pa}$  around this borehole in the last 5 years (Figure 5.6). The  $^{233}\text{Pa}$  occurs in a medium- to coarse-grained sand that the driller's log noted in 1976 was moist from 22.5 to 29 ft.

Kasper (1982) reported analytical results from samples obtained during the drilling of this borehole. Two samples contained ~20 pCi/g  $^{239,240}\text{Pu}$  (at 25 and 112 ft). He attributes the deep sample to some anomalous concentration mechanism at depth. It is also possible that the deep contamination resulted from borehole construction. One sample, from 25 ft, had  $^{241}\text{Am}$  at ~4 pCi/g. All other samples were <1 pCi/g each of  $^{239,240}\text{Pu}$  and  $^{241}\text{Am}$ .

### 5.3.3 Borehole 299-W18-153

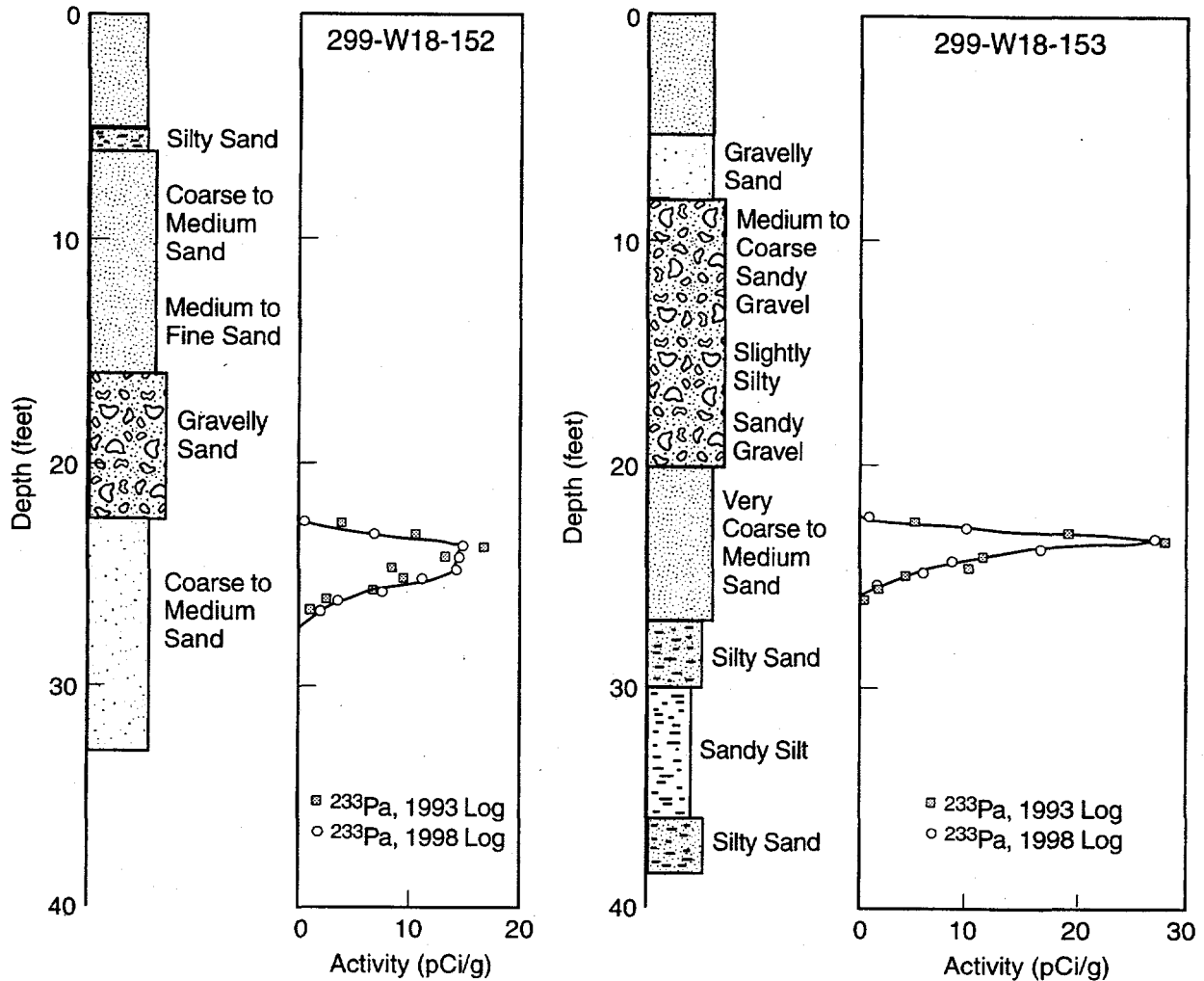
This borehole is located just east of the crib approximately one-quarter the way down the length of the crib.

$^{233}\text{Pa}$  between 22 and 27 ft was the only man-made radionuclide identified. The maximum value was 27 pCi/g at 23.5 ft. The borehole was previously logged in 1993, at which time  $^{233}\text{Pa}$  was identified from 22.5 to 28 ft, with an identical maximum activity of 27 pCi/g at 23.5 ft (see Figure 5.6). Thus, there has been no major change in  $^{233}\text{Pa}$  around this borehole in the last 5 years. As in borehole 299-W18-152, on the opposite side of the crib,  $^{233}\text{Pa}$  occurs in a medium- to coarse-grained sand that is noted in the 1976 driller's log as moist from 22.5 to 29 ft.

Kasper (1982) found  $^{239,240}\text{Pu}$  between 21 and 109 ft in this borehole. The maximum value was 120 pCi/g at 20.9 ft, diminishing quickly to 2 pCi/g at 25 ft and then  $\leq 1$  pCi/g to the bottom of the hole (108 ft). He also found  $^{241}\text{Am}$  between 20 and 106 ft, with the maximum of 31 pCi/g at 20.9 ft.

### 5.3.4 Borehole 299-W18-156

This borehole is located ~15 m north of the crib and ~2 m west of the diversion box. The base of the diversion box is at 17 ft.



RP980700049.12

**Figure 5.6.** Comparison of  $^{233}\text{Pa}$  Activity Versus Depth from 1993 and 1998 Log Data in Boreholes 299-W18-152 and 299-W18-153

$^{233}\text{Pa}$  was found in two zones: 1 to 2.5 and 17.5 to 23.5 ft, with a maximum activity of 10 pCi/g at the deepest data point (23.5 ft).  $^{239}\text{Pu}$  was found from 21 ft to the bottom of the hole. The maximum value was 17.1 nCi/g at 22 ft.

The maximum  $^{233}\text{Pa}$  activity in this borehole is at the same depth as in boreholes 299-W18-08, 299-W18-152, and 299-W18-153. Also, in the latter boreholes,  $^{233}\text{Pa}$  occurs to depths deeper than the total depth of this borehole, indicating that  $^{233}\text{Pa}$  may exist deeper at this location. There is no record of this borehole having ever been logged. However, contamination (500 disintegrations/min) was encountered during drilling in 1976 at 17.5 to 18 ft.

### 5.3.5 Borehole 299-W18-179

This borehole is located at the head end of the crib on centerline. The borehole was drilled through the base of the backfill material (~17 ft) but is north of the perforations in the distributor pipe.

Several man-made radionuclides were found in this borehole. Detector dead time was exceeded between 18.5 and 19.5 ft, so that activities in this interval are higher than reported.  $^{137}\text{Cs}$  was found between 14.5 and 19 ft, with a maximum activity of 900 pCi/g at 16.5 ft.  $^{233}\text{Pa}$  and  $^{239}\text{Pu}$  exist at 21.5 and at 16.5 ft, with maximum activities of 36 pCi/g and 700 nCi/g, respectively, at 16.5 ft.  $^{241}\text{Am}$  was identified but could not be quantified because of interference from  $^{137}\text{Cs}$ .  $^{208}\text{Tl}$  is observed to be elevated over normal Hanford Site levels and not in secular equilibrium with other daughter products of  $^{232}\text{Th}$ . The high  $^{208}\text{Tl}$  is located at 17 to 21 ft; the bottom of the crib is at ~17 ft.

This borehole was last logged in 1993. The zone between 16 to 18 ft exceeds the dead-time correction accuracy limits for both the 1993 and 1998 log data sets. This affects any comparison of logging results over this depth interval; however, the differences are opposite the effects of dead time for the two systems.  $^{137}\text{Cs}$  shows an apparent 13% decrease for this zone between 15 to 18 ft, after natural decay correction.  $^{233}\text{Pa}$  has an apparent 16% increase over the 1993 log results.  $^{239}\text{Pu}$  shows an apparent 123% increase over the 1993 log results (Figure 5.7). The electronic processing system used in the 1993 log data collection would overestimate the concentrations in this high-count-rate zone. The upgraded electronics used in the collection of the 1998 log data underestimate the concentrations in this zone. Because of the protactinium and plutonium increase in opposition to the dead-time effects, the conclusion is that a significant increase in the activity of these radionuclides has occurred over the past 5 years.

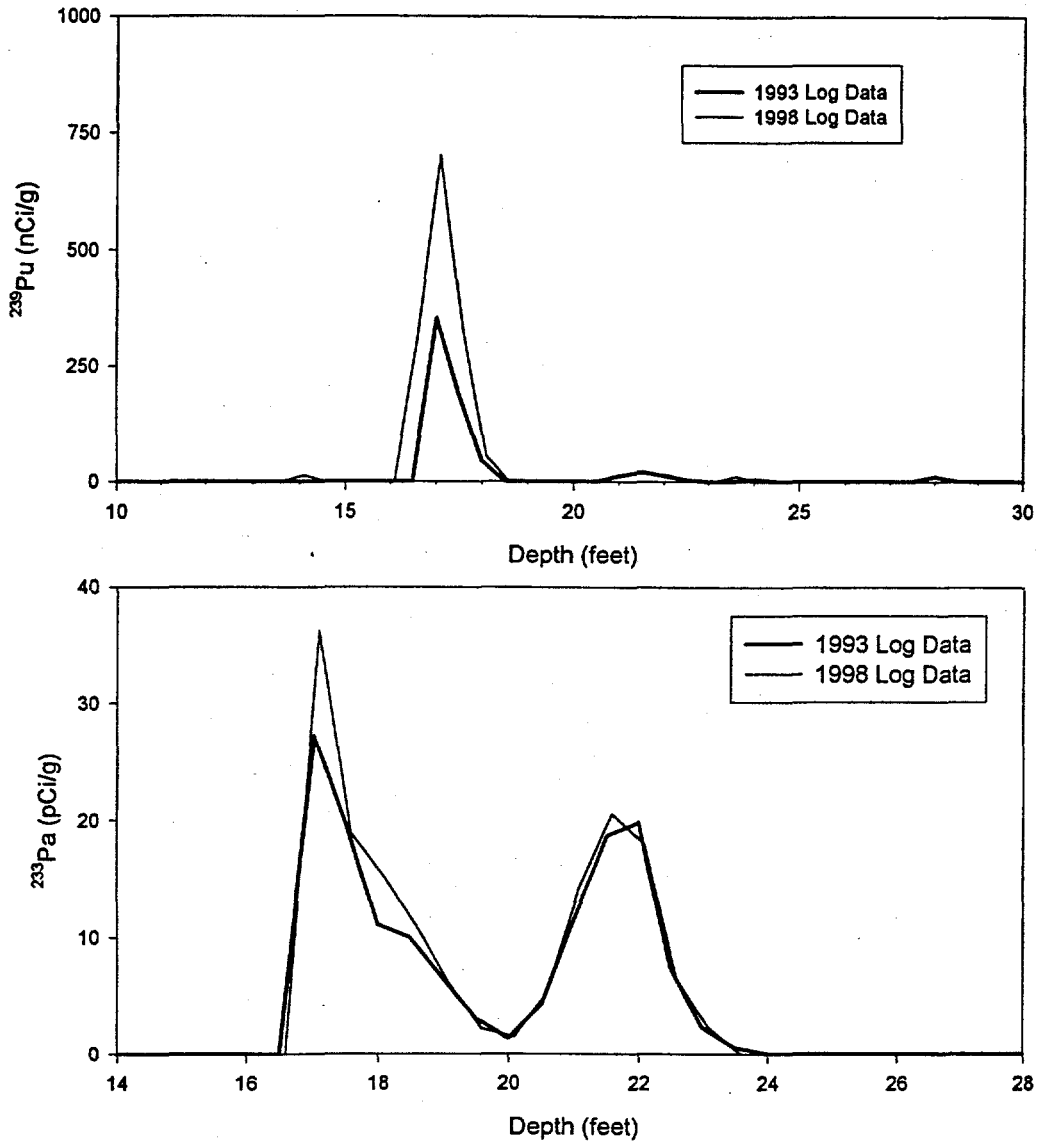
In 1982, Kasper found a maximum of 1,000 nCi/g  $^{239,240}\text{Pu}$  and 400 nCi/g  $^{241}\text{Am}$  at 17 ft.

### 5.3.6 Borehole 299-W18-181

This borehole is located approximately one-fourth the way down the crib along centerline.

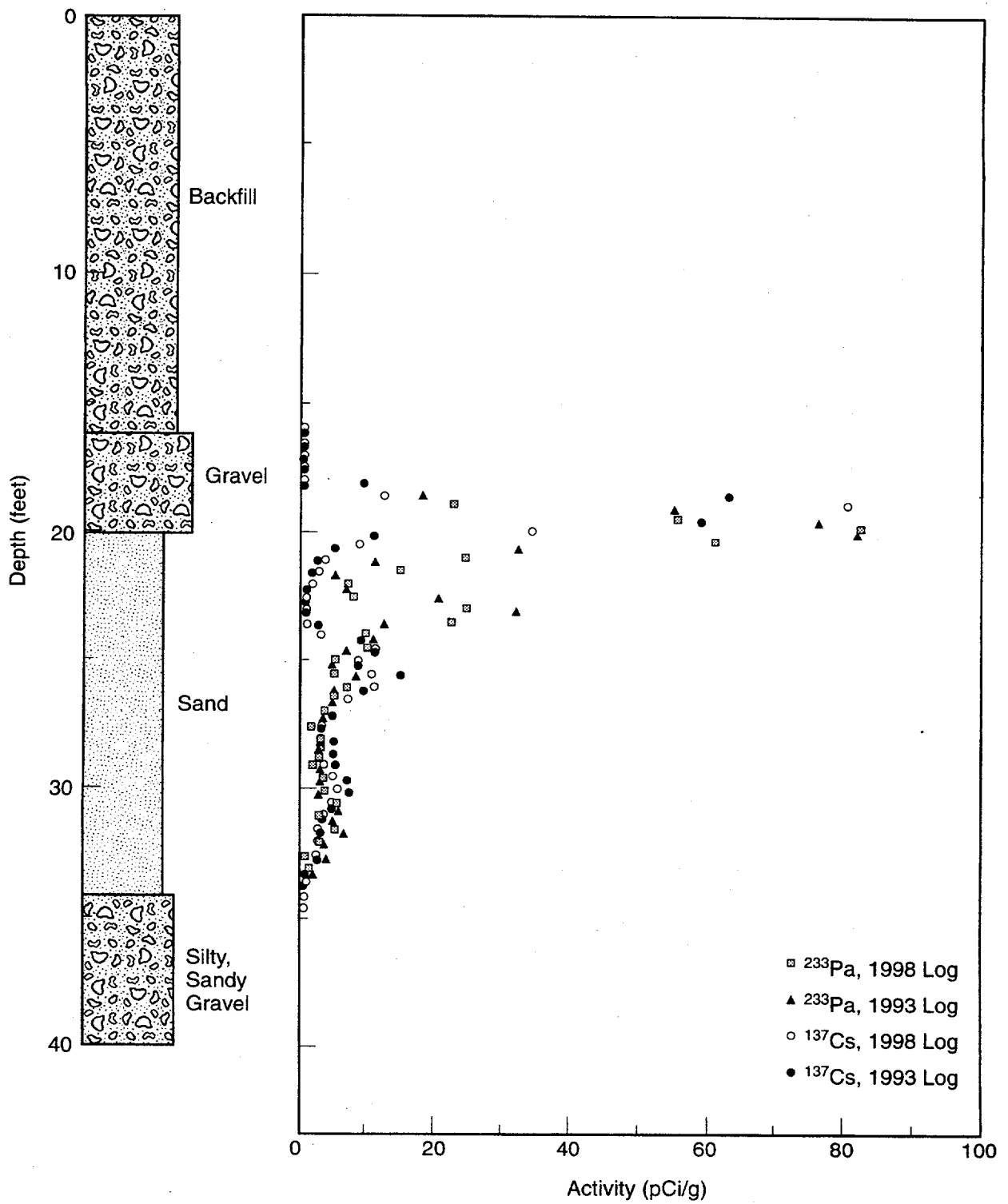
Several man-made radionuclides were identified in this borehole.  $^{137}\text{Cs}$  was identified between 16 and 34 ft, with a maximum activity of 125 pCi/g at 19 ft.  $^{233}\text{Pa}$  was found between 18.5 and 33 ft, with a maximum activity of 85 pCi/g at 20 ft.  $^{239}\text{Pu}$  was identified between 18.5 and 33.5 ft, with a maximum activity of 3,000 nCi/g also at 20 ft.  $^{241}\text{Am}$  was found between 19 and 32 ft, with a maximum activity of 470 nCi/g at 20 ft, but interference from other radionuclides makes quantification questionable. Finally,  $^{208}\text{Tl}$  between 18 and 23 ft is observed to be elevated over normal Hanford Site levels and not in secular equilibrium with other daughter products of  $^{232}\text{Th}$ .

Many of the same photo peaks that appeared in the log data from borehole 299-W18-149 at the 216-Z-1A tile field also appear in the spectra from this borehole. However, the definitive presence of the hydrogen capture photo peak at 2.2 MeV is not prevalent in these log data. Because the photo peaks are the same, it can be stated that neutron and fission events are present in the subsurface at this borehole.



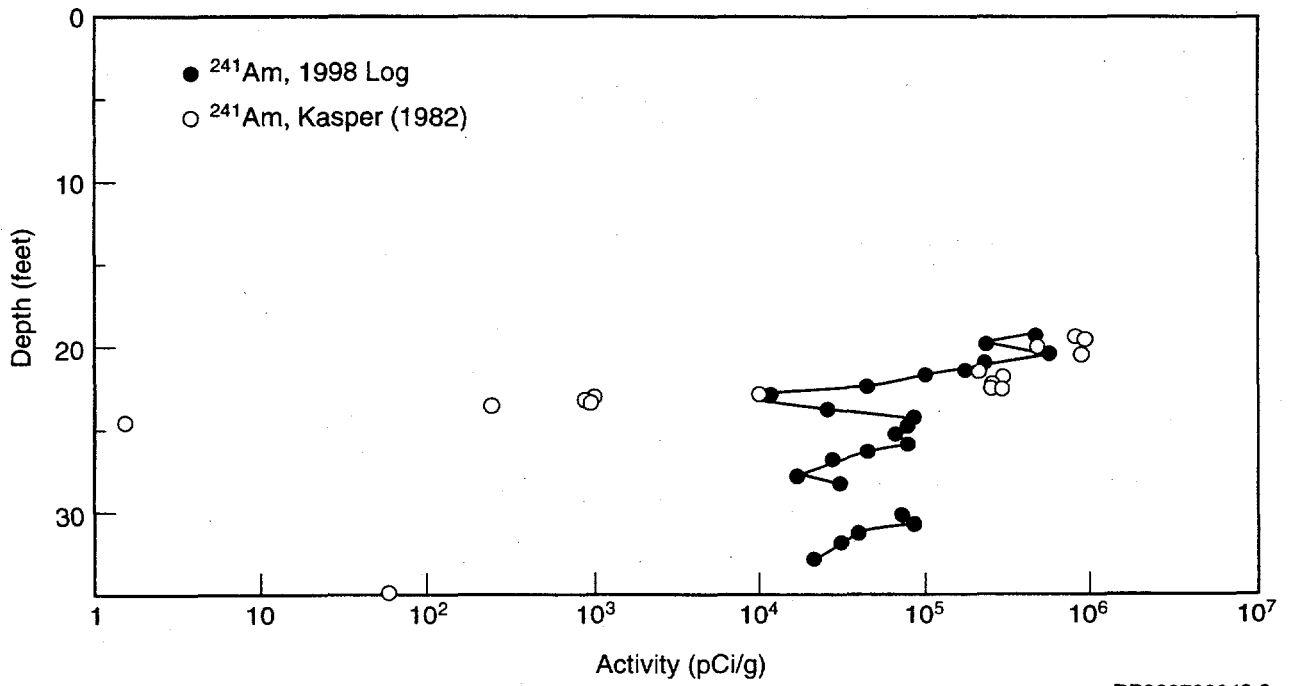
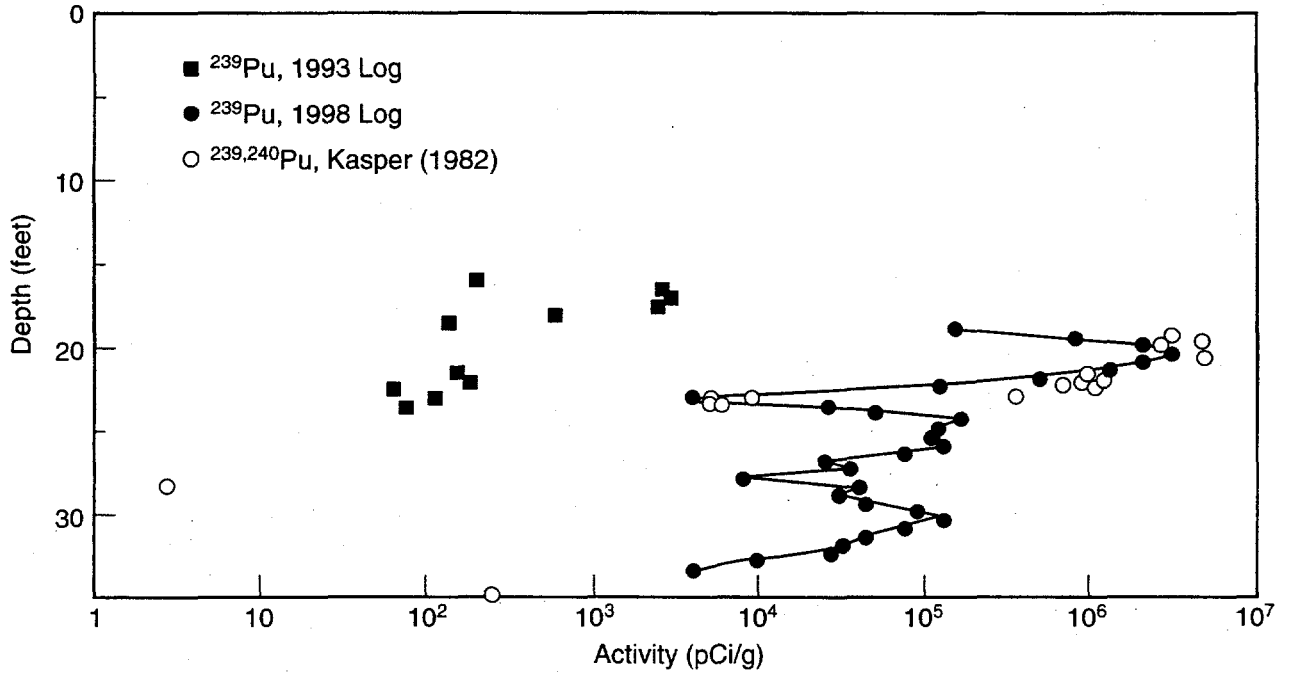
**Figure 5.7.** Comparison of  $^{233}\text{Pa}$  and  $^{239}\text{Pu}$  Activities Versus Depth from 1993 and 1998 Log Data in Borehole 299-W18-179

This borehole was last logged in 1993. The current logging results agree with the 1993 results, indicating no changes in  $^{137}\text{Cs}$ ,  $^{233}\text{Pa}$ ,  $^{239}\text{Pu}$ , or  $^{241}\text{Am}$  distribution in the last 5 years (Figures 5.8 and 5.9). The 1993 results show  $^{137}\text{Cs}$  present between 16 and 33.5 ft, with a maximum of 168 pCi/g at 18.5 ft;  $^{233}\text{Pa}$  present between 18.5 to 28 ft, with a maximum of 84 pCi/g at 20 ft;  $^{239}\text{Pu}$  present between 19 and 26 ft, with a maximum of 3,121 nCi/g at 20 ft; and  $^{241}\text{Am}$  present between 18.5 and 32.5 ft, with a maximum of 377 nCi/g at 20 ft.



RP980700049.11

Figure 5.8. Comparison of  $^{233}\text{Pa}$  and  $^{137}\text{Cs}$  Activities Versus Depth from 1998 and 1993 Log Data in Borehole 299-W18-181



RP980700049.6

**Figure 5.9.** Comparison of  $^{239}\text{Pu}$  and  $^{241}\text{Am}$  Activities Versus Depth from 1993 and 1998 Log and Laboratory Data in Borehole 299-W18-181 (laboratory data from Kasper 1982)

Kasper (1982) found activities of  $^{239,240}\text{Pu}$  as high as 4,880 nCi/g and  $^{241}\text{Am}$  as high as 772 nCi/g beneath the base of the crib (20.5 ft). These values decreased to  $\leq 200$  pCi/g at the base of the sand unit. Kasper found  $^{239,240}\text{Pu}$  and  $^{241}\text{Am}$  in two deeper zones between 23 and 33 and 118 and 128 ft at  $<100$ -pCi/g activities.

### 5.3.7 Borehole 299-W18-182

This borehole is approximately half way between the north and south boundaries of the crib on centerline.

$^{137}\text{Cs}$ ,  $^{233}\text{Pa}$ ,  $^{239}\text{Pu}$ , and  $^{241}\text{Am}$  were the man-made radionuclides identified in this borehole.  $^{137}\text{Cs}$  was found between 16 and 27 ft, with a maximum of 250 pCi/g at 23.5 ft;  $^{233}\text{Pa}$  was found between 19 and 30.5 ft, with a maximum of 30 pCi/g at 20 ft;  $^{239}\text{Pu}$  was found between 18.5 and 29.5 ft, with a maximum of 1,100 nCi/g at 19.5 ft; and  $^{241}\text{Am}$  was found between 19 and 22.5 ft, with a maximum of 2,100 nCi/g at 20.5 ft. The maximum activity for all radionuclides is at or within a meter below the crib bottom (~20 ft) (Figures 5.10 and 5.11).

This borehole was logged in 1993 by the U.S. Department of Energy's Grand Junction Projects Office with a prompt fission neutron tool. The log showed  $^{239}\text{Pu}$  to be present between ~17 and 23 ft, with a maximum near 1,230 nCi/g at  $\leq 20$  ft.

Kasper (1982) found  $^{239,240}\text{Pu}$  up to 2,080 nCi/g and  $^{241}\text{Am}$  up to 1,640 nCi/g just below the base of the crib. These activities decreased to  $\leq 5$  pCi/g below 29 ft.

### 5.3.8 Borehole 299-W18-183

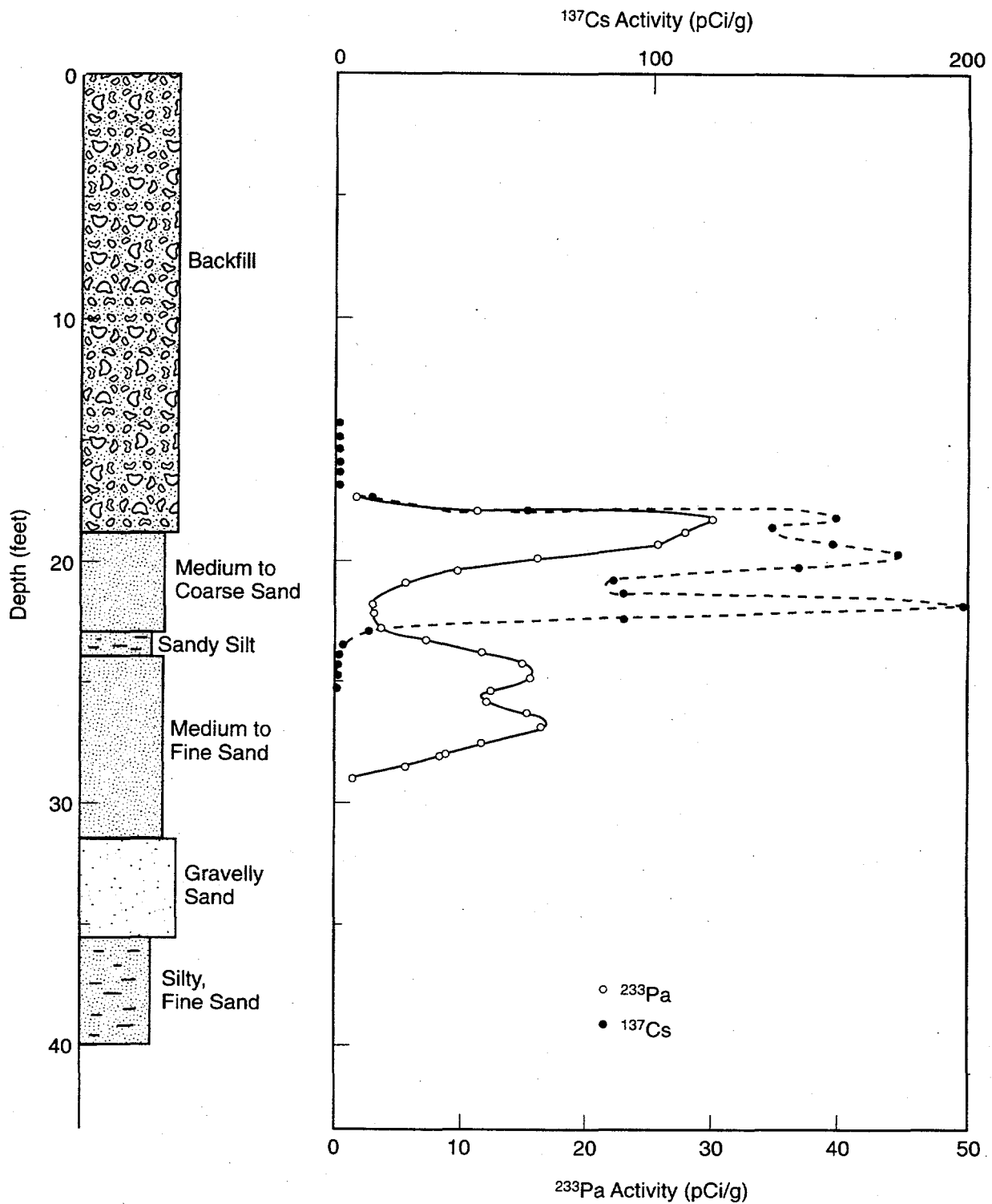
This borehole is located on the crib centerline approximately one-fourth the way up from the south edge.

$^{137}\text{Cs}$  was found from the surface to 1.5 ft and from 6 to 9.5 ft at  $<1$  pCi/g. The borehole was previously logged in 1993, at which time only  $^{137}\text{Cs}$  was identified at 6 to 8 ft, with an activity of ~0.2 pCi/g. The cesium is located well above the distributor pipe (at ~16 to 17 ft) and probably resulted from a surface source.  $^{233}\text{Pa}$  was identified from 24 to 28 ft, with a maximum activity of 2 pCi/g at 27.5 ft.

Kasper (1982) found  $^{239,240}\text{Pu}$  and  $^{241}\text{Am}$  in several samples from throughout the depth of the borehole but all activities were  $<0.5$  pCi/g, except at 25 ft where activities were 8.29 pCi/g  $^{239,240}\text{Pu}$  and 1.3 pCi/g  $^{241}\text{Am}$ .

### 5.3.9 Borehole 299-W18-185

This borehole is located on the centerline ~20 m from the head end of the crib.



RP980700049.9

Figure 5.10.  $^{137}\text{Cs}$  and  $^{233}\text{Pa}$  Activities Versus Depth in Borehole 299-W18-182



Four man-made radionuclides were identified in the borehole.  $^{137}\text{Cs}$  was found between 17.5 and 23.5 ft, with a maximum of 216 pCi/g at 19.5 ft;  $^{233}\text{Pa}$  was found between 18.5 and 26 ft, with a maximum of 61 pCi/g at 19.5 ft;  $^{241}\text{Am}$  was found between 19 and 22.5 ft, with a maximum of 386 nCi/g at 21.5 ft (interference from the Compton downscatter from  $^{137}\text{Cs}$  makes this value semi-quantitative); and  $^{239}\text{Pu}$  was found between 18.5 and 24 ft, with a maximum of 1,047 nCi/g at 20 ft. In addition,  $^{208}\text{Tl}$  was found at 21.5 ft that is not in secular equilibrium with the parent  $^{232}\text{Th}$ .

The borehole was last logged in 1993. At that time,  $^{137}\text{Cs}$  was found between 17.5 and 23.5 ft, with a maximum of 240 pCi/g at 19 ft;  $^{233}\text{Pa}$  was found between 18.5 and 25 ft, with a maximum of 61 pCi/g at 19.5 ft;  $^{239}\text{Pu}$  was identified between 18.5 and 23.5 ft, with a maximum of 1,012 nCi/g at 21 ft; and  $^{241}\text{Am}$  was identified between 19 and 22.5 ft, with a maximum of 298 nCi/g at 19.5 ft. Based on the 1993 data and the most current logging information, there do not appear to be any changes in the distribution of man-made radioisotopes in this borehole in the last 5 years.

Kasper (1982) found maximum activities for  $^{239,240}\text{Pu}$  and  $^{241}\text{Am}$  of 3,080 and 863 nCi/g, respectively, just below the crib bottom (~21 ft). All activities decreased to  $\leq 50$  pCi/g below a depth of ~23 ft.

## 6.0 Discussion

Man-made, gamma-ray-emitting radionuclides were found at depth in all boreholes logged at the 216-Z-1A tile field and 216-Z-12 crib. Only one borehole at the 216-Z-9 trench revealed man-made radionuclides;  $^{137}\text{Cs}$  was identified at the surface. However, contamination is known to exist at 216-Z-9 in boreholes that were not logged in 1998 (Fecht 1977).

Contamination associated with the three boreholes located along the tile field centerline and the one borehole located half way between the centerline and the end of the first diagonal was shown to be at or just below the bottom of the tile field and extending to greater depths. Boreholes located near the ends of the diagonals showed contamination only at depth. This suggests that wastes drained dominantly from the center distributor pipe and did not reach the ends of the laterals. Contamination found at depth in the lateral boreholes must have been emplaced by lateral movement from the center of the tile field because downward movement near the boreholes would have resulted in contamination higher in the soil column. These observations are consistent with those made by Price et al. (1979).

All boreholes at the 216-Z-12 crib showed contamination just below the base of the crib and extending to  $\leq 10$  ft deeper. The  $^{233}\text{Pa}$  noted in the two lateral boreholes located outside the crib boundary also occurs at the level equivalent to the base of the crib. The contamination in these boreholes must have resulted from lateral movement from the base of the crib.

### 6.1 Changes in Subsurface Radionuclide Distribution

Changes in subsurface radionuclide distribution (activity) were suggested at two boreholes at the 216-Z-1A tile field and one borehole at the 216-Z-12 crib. The presence of a change was based on comparison of spectral gamma-ray log data collected in 1991 or 1993 and the log data collected in 1998. Apparent changes were noted in several other boreholes but those changes probably resulted from differences in calibration, environmental correction (casing thickness), or dead-time characteristics of the systems used for logging in 1993 and 1998. In one instance, borehole 299-W18-149, apparent changes in radionuclide distribution are masked by subsurface neutron and fission-induced gamma activity. Eight of the boreholes had no previous spectral log data, and an analysis of radionuclide redistribution could not be made.

The two boreholes showing changes in radionuclide activity at the 216-Z-1A tile field are 299-W18-159 and 299-W18-175. Both of the boreholes lie along the centerline distributor pipe. In borehole 299-W18-159,  $^{137}\text{Cs}$  increased by a factor of 3 from 45 to 55 ft (after natural decay correction),  $^{233}\text{Pa}$  decreased by approximately one-third of its activity noted in 1991 between 45 and 50 ft, and  $^{239}\text{Pu}$  decreased by 7% from 17 to 30 ft.

Borehole 299-W18-175 showed a decrease of 7% in  $^{233}\text{Pa}$  activity at 58 ft since 1993 but an increase of 51% activity between 22 and 53 ft and an increase of 22% between 95 and 100 ft.

At the 216-Z-12 crib, only borehole 299-W18-179 showed definite evidence of change in radionuclide activity. The log results indicate a 16% increase in  $^{233}\text{Pa}$  and a 123% increase in  $^{239}\text{Pu}$  over the depth interval 17 to 20 ft (see Figure 5.7). Because this interval exceeds the dead-time correction accuracy, the increase is larger than reported. The change in  $^{239}\text{Pu}$  is due probably to lateral movement. This conclusion is based on the fact that only the intensity of  $^{239}\text{Pu}$  activity and not the depth profile has changed. In other words, the ratio of the full width at half maximum to the maximum intensity is the same in the 1993 and the 1998 logs.

Also,  $^{137}\text{Cs}$  shows an apparent 13% decrease, after natural decay correction, between 17 and 20 ft. This could be a result of the different dead-time errors of the different instruments, but has not been quantified.

## 6.2 Comparison of Borehole Spectral Gamma-Ray Logs and Laboratory Data

It was initially thought that the laboratory analyses reported by Price et al. (1979) for samples from the 216-Z-1A tile field and by Kasper (1982) for samples from the 216-Z-12 crib could be used to compare with the current logging results to discern any changes in the depth distribution of plutonium and americium that occurred since their sampling activities. This turned out not to be as easily done as was initially hoped for, as discussed in Section 4.3.

The quality of the comparison of laboratory data with log data varied from borehole to borehole. One of the better comparisons is shown in Figure 5.4 that shows the  $^{239}\text{Pu}$  and  $^{241}\text{Am}$  distributions with depth in borehole 299-W18-175 from the 216-Z-1A tile field. The data from the two sources show the same general depth distribution trend but have absolute differences of up to an order of magnitude, with several pairs of data points showing greater differences. This is typical for comparisons at boreholes. Figures 5.9 and 5.11 show similar comparisons for data from boreholes 299-W-181 and 299-W18-185 at the 216-Z-12 crib. The agreement between the data in these examples is somewhat closer than in Figure 5.4 but the situation illustrated in Figure 5.4 is more typical. Generally, the depth of the maximum values of log-derived and laboratory-derived activities agree favorably but the magnitudes usually agree less favorably.

## 6.3 Stratigraphic Control of Contaminant Distribution

Price et al. (1979) and Kasper (1982) both noted a relationship between lithology and contaminant distribution. Price et al. noted that the highest concentration of plutonium and americium was just beneath the center distribution pipe of the 216-Z-1A tile field and that, with the exception of isolated silt lenses,  $^{239,240}\text{Pu}$  concentrations  $>1,000$  nCi/g were not found below  $\sim 2$  m beneath the facility. Plutonium

and americium concentrations at depths >2 m beneath the bottom of the tile field were generally associated with an increase in silt content of the sediments or with boundaries between major sedimentary units. Kasper noted the same effect at the 216-Z-12 crib in one borehole (299-W18-181) that encountered contamination at depth.

The results of the 1998 logging are in general agreement with the conclusions of Price et al. (1979) and Kasper (1982). In several boreholes, relationships between the occurrence of contaminants and lithology can be noted. In several boreholes, however, no definite relationships were observed generally because either the stratigraphy was not well defined in driller's logs or because of uncertainties in depth determinations as discussed in Section 4.3.

#### 6.4 $^{233}\text{Pa}$ as Surrogate for $^{237}\text{Np}$ ( $^{241}\text{Am}$ )

$^{233}\text{Pa}$ , with a half-life of 27.4 days, was observed in most boreholes by measuring the photo peak at 312 keV. Because  $^{233}\text{Pa}$  remains detectable in 1998, the source for the  $^{233}\text{Pa}$  must be a parent radioisotope.  $^{233}\text{Th}$  is one parent of  $^{233}\text{Pa}$ , but because the  $^{233}\text{Th}$  isotope has a 22-minute half-life, it cannot be the source in these boreholes. Another and more probable parent of  $^{233}\text{Pa}$  is  $^{237}\text{Np}$ , with a half-life of 2,000,000 years. Clearly, the  $^{233}\text{Pa}$  is in secular equilibrium with  $^{237}\text{Np}$ . Because the direct gamma ray measured is the  $^{233}\text{Pa}$ , this is the activity presented in the log plots; however, in those boreholes, this represents the activity of  $^{237}\text{Np}$ . This is an important point in terms of the potential for contaminant migration in the vadose zone, because the geochemistry of  $^{237}\text{Np}$  may be a determining factor for the occurrence of  $^{233}\text{Pa}$ . The daughter product of  $^{233}\text{Pa}$  is  $^{233}\text{U}$ , with a half-life of 27 days, and the daughter of  $^{233}\text{U}$  is  $^{229}\text{Th}$ , with a half-life of 160,000 years. Basically,  $^{229}\text{Th}$  is increasing where  $^{233}\text{Pa}$  is observed. Migration characteristics of  $^{229}\text{Th}$  also may be an issue in terms of groundwater protection. Note, however, that the activity of  $^{229}\text{Th}$  is very low due to its long half-life. Further,  $^{229}\text{Th}$  is highly retarded under most environmental conditions.

The parent isotope for  $^{237}\text{Np}$  is  $^{241}\text{Am}$ , one of the more abundant radioisotopes at the Hanford Site. As shown in this document,  $^{241}\text{Am}$  can be detected by spectral gamma methods. The photo peak used is the relatively weak 59.5 keV with an abundance of 36.3% (36.3 emissions per 100 alpha decays), resulting in a fairly high detection threshold.  $^{233}\text{Pa}$ , however, is much more easily detected and has a much lower detection threshold. Thus,  $^{233}\text{Pa}$  may give a better picture of  $^{241}\text{Am}$  distribution than actual measurements of  $^{241}\text{Am}$ .

#### 6.5 $^{208}\text{Th}$

In 1965 and 1966, an experimental process was carried out in the  $\text{UO}_3$  Plant to convert commercial thorium nitrate into thorium oxide powder for fabrication of reactor target elements for  $^{233}\text{U}$  production. During the same time, the Plutonium-Uranium Extraction (PUREX) Plant processed powdered thorium oxide fuel targets that had been irradiated for production of  $^{233}\text{U}$  (Gerber 1993). During that campaign, 194 t of thorium oxide were processed (ISO 1967). As part of the process of purifying natural  $^{232}\text{Th}$  for

reactor-grade thorium, all members of the  $^{232}\text{Th}$  decay chain (except  $^{228}\text{Th}$ ) were removed (Hughey 1966). As a consequence, the daughters of  $^{232}\text{Th}$  were enriched relative to the  $^{232}\text{Th}$  in the process waste.

$^{208}\text{Tl}$  is a daughter product of naturally occurring  $^{232}\text{Th}$ .  $^{208}\text{Tl}$ , in excess of what is expected from secular equilibrium with natural thorium, was found associated with 5 of the 8 boreholes logged at the 216-Z-1A tile field and with 5 of 9 boreholes logged at the 216-Z-12 crib. No documentation was found that cited the fate of the wastes from purification of either the thorium oxide or  $^{233}\text{U}$ . The 1998 logging results suggest, however, that some of the process waste may have been disposed to the tile field and the crib.

## 6.6 Gross Gamma and Radon

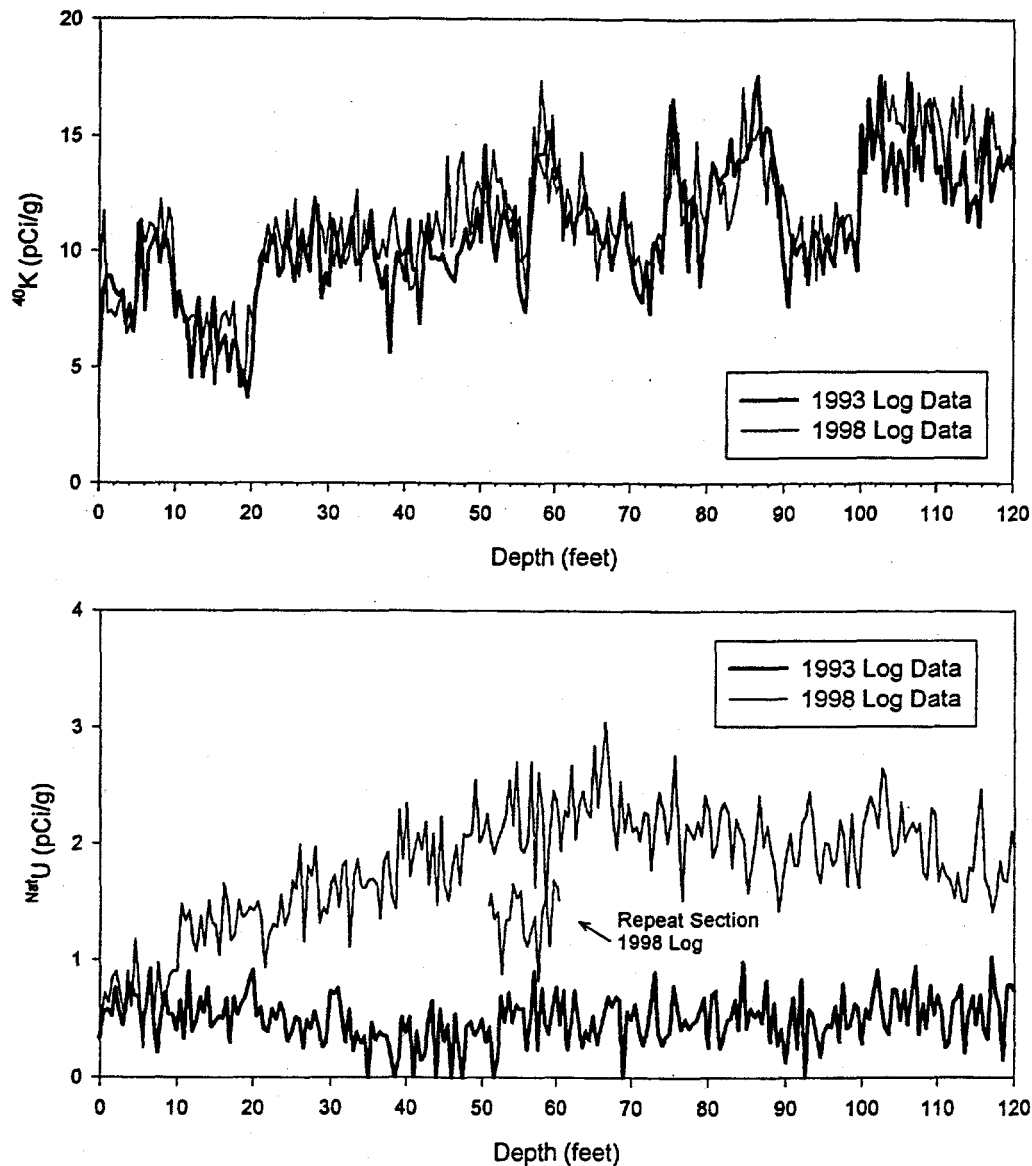
Atmospheric pumping of radon gas, a daughter product of naturally occurring uranium, occurred in several of the boreholes, resulting in systematic changes in the levels of radon gas inside or just outside the casing. This caused the observed uranium concentrations to change when compared to the previous logging results. Also, a significant time lapse between the main pass and the repeat pass can cause apparent differences in uranium content during a single logging event.

Data for borehole 299-W18-169 exhibit this phenomenon clearly (Figure 6.1). The comparison of the 1998 and 1993 data shows excellent agreement for the natural  $^{40}\text{K}$ , which is not influenced by radon pumping, but very large deviations for the uranium. Figure 6.1 shows that, as the 1998 logging proceeded, the effect of radon pumping increased until logging reached ~70 ft. At that time, the radon content began to decrease until the last operation of the repeat log when the apparent uranium concentration is midway between the 1993 and first-pass 1998 results. Note that the repeat section is plotted also for potassium, but since the repeat log is within statistical precision, it is difficult to see in the overlapping responses. As a consequence of the apparent levels of uranium changing in the detection volume surrounding the logging instrument, the gross gamma-ray count rate also changes. Therefore, the gross gamma-ray spectra from the main pass and from the repeat pass deviate more than statistical precision.

## 6.7 Neutron Flux

The presence of transuranics around some of the boreholes causes fission processes that, in turn, produce a neutron flux. However, the high degree of visibility of these processes found in the gamma-ray spectra from some boreholes was not expected.

After searching libraries for common contaminants encountered at the Hanford Site, it was discovered that several boreholes contained many unidentified gamma-ray emitters. Also, neutron flux was observed by indirect means in data from borehole 299-W18-149, where the 2.22-MeV gamma ray from thermal neutron capture with hydrogen was measured. The borehole is cased with polyvinyl chloride, which not only contains hydrogen but also chlorine, and the neutron capture gamma rays at 1,959, 1,951, 1,165, and 788 keV of chlorine are visible in the spectra at the highest gross gamma-ray response at 12 ft. Note



**Figure 6.1.** Comparison of Gross Gamma-Ray Plots from 1998 and 1993, Illustrating Radon Pumping in Borehole 299-W18-169

that the prominent 6,111-keV chlorine gamma ray was not observed because it is outside the data-collection range of 0 to 3,000 keV. Likewise, because there is no iron casing in this borehole, the iron capture gamma rays were not observed.

Borehole 299-W18-159 also exhibited a characteristic indicative of neutron flux but with differences from the spectra obtained from borehole 299-W18-149. An unusually high Compton background above the 2,614-keV peak of thorium was most likely from capture gamma rays above 2,614 keV. The

hydrogen capture was visible in spectra from borehole 299-W18-159 but not as significant as it was in borehole 299-W18-149. This is to be expected, however, because there is no polyvinyl chloride in borehole 299-W18-159. Many other gamma rays were observed in some intervals from several boreholes, typically when the transuranics were >20 to 50 nCi/g.

## 7.0 Conclusions

Twenty-one boreholes were monitored by spectral gamma-ray logging in April 1998 at the 216-Z-1A tile field, the 216-Z-9 trench, and the 216-Z-12 crib. These facilities were chosen to be monitored because they were identified as containing some of the most significant sources of radioactive contamination in the Hanford Site vadose zone.

$^{137}\text{Cs}$ ,  $^{233}\text{Pa}$ ,  $^{239}\text{Pu}$ , and  $^{241}\text{Am}$  were identified in the logs from the 216-Z-1A tile field and the 216-Z-12 crib. The maximum activities found were in borehole 299-W18-159 at the tile field, where  $^{137}\text{Cs}$  was 23 pCi/g,  $^{233}\text{Pa}$  was 63 pCi/g,  $^{239}\text{Pu}$  was 25,000 nCi/g, and  $^{241}\text{Am}$  was 2,500 nCi/g. The only man-made radionuclide identified at the 216-Z-9 trench was  $^{137}\text{Cs}$ , at <1 pCi/g near the surface in 1 borehole.

Comparisons of data collected in 1998 with data from past logging events suggest there have been some changes in radionuclide activity around two boreholes at the 216-Z-1A tile field and one borehole from the 216-Z-12 crib.  $^{137}\text{Cs}$  activity increased and  $^{233}\text{Pa}$  activity decreased in one zone, and  $^{239}\text{Pu}$  activity decreased in a second zone in one borehole at the tile field.  $^{233}\text{Pa}$  activity decreased in one zone and increased in another zone in a second borehole at the tile field. At the crib, there was a possible decrease in  $^{137}\text{Cs}$  activity and an increase in  $^{233}\text{Pa}$  and  $^{239}\text{Pu}$  activity in one borehole. Apparent changes were noticed in several other boreholes but those changes are attributed to differences in data collection and data processing between the 1998 and past logging events.

Comparisons of log data with laboratory analyses from samples obtained during drilling of the boreholes were not as useful for delineating changes in activity as were comparisons with past logging data because of the differences in the material samples and in the analytical methods.

$^{208}\text{Tl}$  was identified in several boreholes in excess of what is expected from secular equilibrium with its parent, natural thorium. This suggests that wastes from early attempts to produce  $^{233}\text{U}$  from thorium oxide may have been disposed to the Plutonium Finishing Plant waste disposal facilities.

The large quantities of transuranics present around some boreholes produce large neutron fluxes, resulting in some unidentified gamma rays that result from neutron activation of borehole construction materials and the backfill soils.

## 8.0 References

- Additon, M. K., K. R. Fecht, T. L. Jones, and G. V. Last. 1978a. *Scintillation Probe Profiles, 200 East Area Crib Monitoring Wells*. RHO-LD-28, Rockwell Hanford Operations, Richland, Washington.
- Additon, M. K., K. R. Fecht, T. L. Jones, and G. V. Last. 1978b. *Scintillation Probe Profiles, 200 West Area Crib Monitoring Wells*. RHO-LD-29, Rockwell Hanford Operations, Richland, Washington.
- Bjornstad, B. N., K. R. Fecht, and A. M. Tallman. 1987. *Quaternary Stratigraphy of the Pasco Basin Area, South-Central Washington*. RHO-BW-SA-563A, Rockwell Hanford Operations, Richland, Washington.
- Brodeur, J. R., R. K. Price, R. D. Wilson, and C. J. Koizumi. 1993. *Results of Spectral Gamma-Ray Logging of Select Boreholes for the Aggregate Area Management Study*. WHC-SD-EN-TI-021, Westinghouse Hanford Company, Richland, Washington.
- Chamness, M. A., S. S. Teel, D. L. McAlister, A. W. Pearson, K.R.O. Barton, R. W. Fruland, and R. E. Lewis. 1991. *Z Plant Geologic and Geophysics Data Package for the 200 Aggregate Area Management Study*. WHC-SD-EN-DP-020, Westinghouse Hanford Company, Richland, Washington.
- Delaney, C. D., K. A. Lindsey, and S. P. Reidel. 1991. *Geology and Hydrology of the Hanford Site: A Standardized Text for Use in Westinghouse Hanford Company Documents and Reports*. WHC-SD-ER-TI-003, Westinghouse Hanford Company, Richland, Washington.
- DOE (see U.S. Department of Energy)
- Fecht, K. R., G. V. Last, and K. R. Price. 1977. *Evaluation of Scintillation Probe Profiles from 200 Area Crib Monitoring Wells*. ARH-ST-156, Volume III, Atlantic Richfield Hanford Company, Richland, Washington.
- Gerber, M. S. 1993. *Brief History of PUREX and UO<sub>3</sub> Facilities*. WHC-MR-0437, Westinghouse Hanford Company, Richland, Washington.
- Heistand, B. E., and E. F. Novak. 1984. *Parameter Assignments for Spectral Gamma-Ray Borehole Calibration Models*. GJBX-2(84), Bendix Field Engineering Corporation, Grand Junction, Colorado.
- Horton, D. G. 1998. *Monitoring Plan for Borehole Logging at 216-Z-1A Tile Field, 216-Z-9 Trench, and 216-Z-12 Crib*. PNNL-11878, Pacific Northwest National Laboratory, Richland, Washington.
- Hughey, C. C. 1966. *Evaluation of Radiologic Hazards Associated with Conversion of Thorium Nitrate to Thorium Oxide*. ISO-431, Isochem, Inc., Richland, Washington.

Isochem, Inc. (ISO). 1967. *PUREX Plan: Thorium Process Operations Report*. ISO-419, Richland, Washington.

Johnson, V. G. 1997. "4.1 Major Sources." In *Hanford Site Groundwater Monitoring for Fiscal Year 1996*. PNNL-11470, M. J. Hartman and P. E. Dresel (eds.), Pacific Northwest National Laboratory, Richland, Washington.

Kasper, R. B. 1982. *216-Z-12 Transuranic Crib Characterization: Operational History and Distribution of Plutonium and Americium*. RHO-ST-44, Rockwell Hanford Operations, Richland, Washington.

Koizumi, C. J., J. R. Brodeur, W. H. Ulbricht, and R. K. Price. 1991. *Calibration of the RLS HPGc Spectral Gamma Ray Logging System*. WHC-EP-0464, Westinghouse Hanford Company, Richland, Washington.

Koizumi, C. J., J. R. Brodeur, R. K. Price, J. E. Meisner, and D. C. Stromswold. 1994. "High-Resolution Gamma-Ray Spectrometry Logging for Contamination Assessment." *Nucl. Geophys.* 8:149-164.

Lindsey, K. A. 1991a. *Geologic Setting of the 200 West Area - An Update*. WHC-SD-EN-TI-008, Westinghouse Hanford Company, Richland Washington.

Lindsey, K. A. 1991b. *Revised Stratigraphy for the Ringold Formation, Hanford Site, South-Central Washington*. WHC-SD-EN-EE-004, Westinghouse Hanford Company, Richland, Washington.

Lindsey, K. A. 1996. *The Miocene to Pliocene Ringold Formation and Associated Deposits of the Ancestral Columbia River System, South-Central Washington and North-Central Oregon*. Open-File Report 96-8, Washington State Department of Natural Resources, Olympia, Washington.

Price, S. M., R. B. Kasper, M. K. Additon, R. M. Smith, and G. V. Last. 1979. *Distribution of Plutonium and Americium Beneath the 216-Z-1A Crib: A Status Report*. RHO-ST-17, Rockwell Hanford Operations, Richland, Washington.

Randall, R. R. 1994. *Calibration of the Radionuclide Logging System Germanium Detector*. WHC-SD-EN-TI-292, Westinghouse Hanford Company, Richland, Washington.

Ridgway, K. R., M. D. Veatch, and D. T. Crawley. 1971. *216-Z-9 Crib History and Safety Analysis*. ARH-2207, Atlantic Richfield Hanford Company, Richland, Washington.

Rohay, V. J., K. J. Swett, and G. V. Last. 1994. *1994 Conceptual Model of the Carbon Tetrachloride Contamination in the 200 West Area at the Hanford Site*. WHC-SD-EN-TI-248, Westinghouse Hanford Company, Richland, Washington.

Smith, A. E. 1973. *Nuclear Reactivity Evaluations of 216-Z-9 Enclosed Trench*. ARH-2915, Atlantic Richfield Hanford Company, Richland, Washington.

Stromswold, D. C. 1994a. *Technical Evaluation of Software for Gamma-Ray Logging System*. PNL-9807, Pacific Northwest Laboratory, Richland, Washington.

Stromswold, D. C. 1994b. *Calibration Facilities at Hanford for Gamma-Ray and Fission-Neutron Well Logging*. PNL-9958, Pacific Northwest Laboratory, Richland, Washington.

Tallman, A. M., K. R. Fecht, M. C. Marratt, and G. V. Last. 1979. *Geology of the Separations Areas, Hanford Site, South-Central Washington*. RHO-ST-23, Rockwell Hanford Operations, Richland, Washington.

U.S. Department of Energy (DOE). 1988. *Consultation Draft, Site Characterization Plan*. DOE/RL-0164, 9 Vols., Office of Civilian Radioactive Waste Management, Washington, D.C.

U.S. Department of Energy (DOE). 1992. *Z Plant Source Aggregate Area Management Study Report*. DOE/RL-91-58, Richland Operations Office, Richland, Washington.

Wood, V. W. 1958. *Index of CPD Crib Building Numbers Designs of CPD Radioactive Liquid Waste Disposal Sites*. NW-55176, Part II, General Electric Hanford Atomic Products Operation, Richland, Washington.

Waste Management Federal Services, Inc. Northwest Operations (WMNW). 1998. "Section 17.0, Geophysical Logging." In *Operational Environmental Monitoring*. WMNW-CM-004, Richland, Washington.

## **Appendix**

### **Borehole Logging Data**

# Appendix

## Borehole Logging Data

This appendix contains log header sheets, depth-versus-activity plots, acceptance quality assurance processing plots, and log analysis summaries for each borehole logged at the 216-Z-1A tile field, 216-Z-9 trench, and 216-Z-12 crib. All logging data were collected by Waste Management Federal Services, Inc., Northwest Operations according to procedures in WMNW (1998a). Log data analysis was completed by Three Rivers Scientific according to procedures in WMNW (1998b). None of the depths noted on the plots in this appendix are corrected for casing stickup.

### References

WHC-SD-EN-TI-292. 1994. *Calibration of the Radionuclide Logging System Germanium Detector*. R. R. Randall, Westinghouse Hanford Company, Richland, Washington.

WMNW (Waste Management Federal Services, Inc., Northwest Operations). 1998a. "Section 17.0, Geophysical Logging." In *Operational Environmental Monitoring*. WMNW-CM-004, Richland, Washington.

WMNW (Waste Management Federal Services, Inc., Northwest Operations). 1998b. "Section 18.0, Geophysical Log Data Analysis." In *Operational Environmental Monitoring*. WMNW-CM-004, Richland, Washington.

# RLS Spectral Gamma Ray Borehole Survey

## Waste Management Federal Services NW

### Log Header

Project: Z Crib Geophysics

Well: 299-W15-82

Log Type: HPGe Spectral Gamma Ray

#### Borehole Information

Well ID	NONE	Water Depth	No Data	Total Depth	101 ft
Elevation Reference	No Data	Elevation	No Data ft		
Depth Reference	Top of Casing	Casing Stickup	2.33 ft		
Casing Diameter	8 in ID	Depth Interval	0 to 101 ft	Thickness	0.28 in
Casing Diameter	in	Depth Interval	ft	Thickness	in

#### Logging Information

Log Type	HPGe Spectral Gamma Ray	
Company	Waste Management Federal Services NW	
Date/Archive File Name	Apr. 6&8, 1998	H2W15082
Logging Engineers	R. Wilson	
Instrument Series	RLSG3.1	
Logging Unit	RLS2	
Depth Interval	2 to 75.5 ft	Prefix B196
	38 to 43 ft	Prefix B200
Instrument Calibration Date	Sep. 9, 1997	
Calibration Report	WHC-SD-EN-TI-292, Rev. 0	

#### Analysis Information

Company	Three Rivers Scientific
Analyst	Russ Randall
Date	April 10, 1998

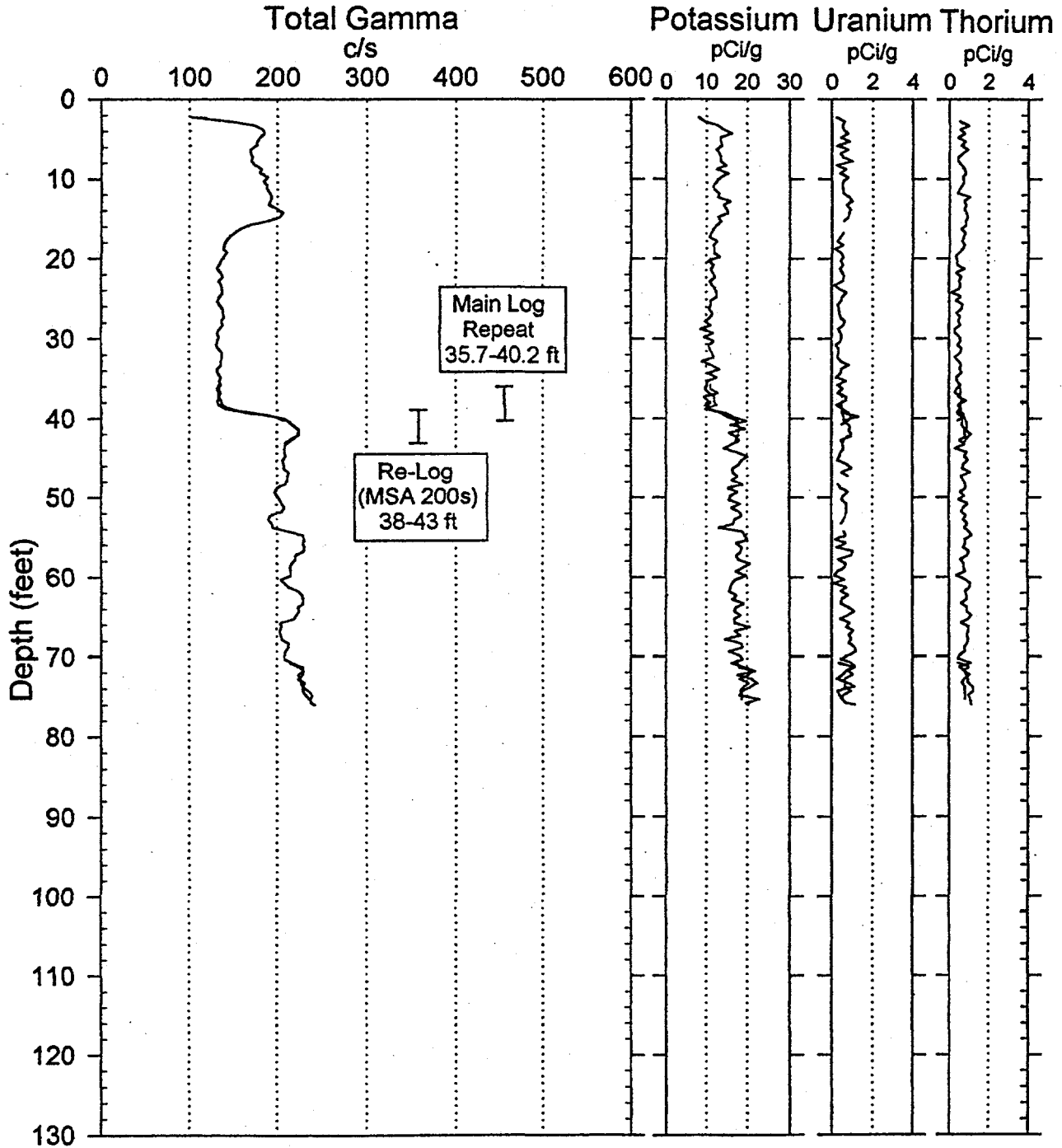
Notes: No man-made radionuclides observed. Therefore, no plot for man-made gammaray emitters, and the repeat plot covers both potassium and thorium.

# RLS Spectral Gamma Ray Borehole Survey

## Waste Management Federal Services NW

Project: Z Crib Geophysics  
Borehole: 299-W15-82

Log Date: Apr. 6 & 8, 1998  
Naturally Occurring Radionuclides



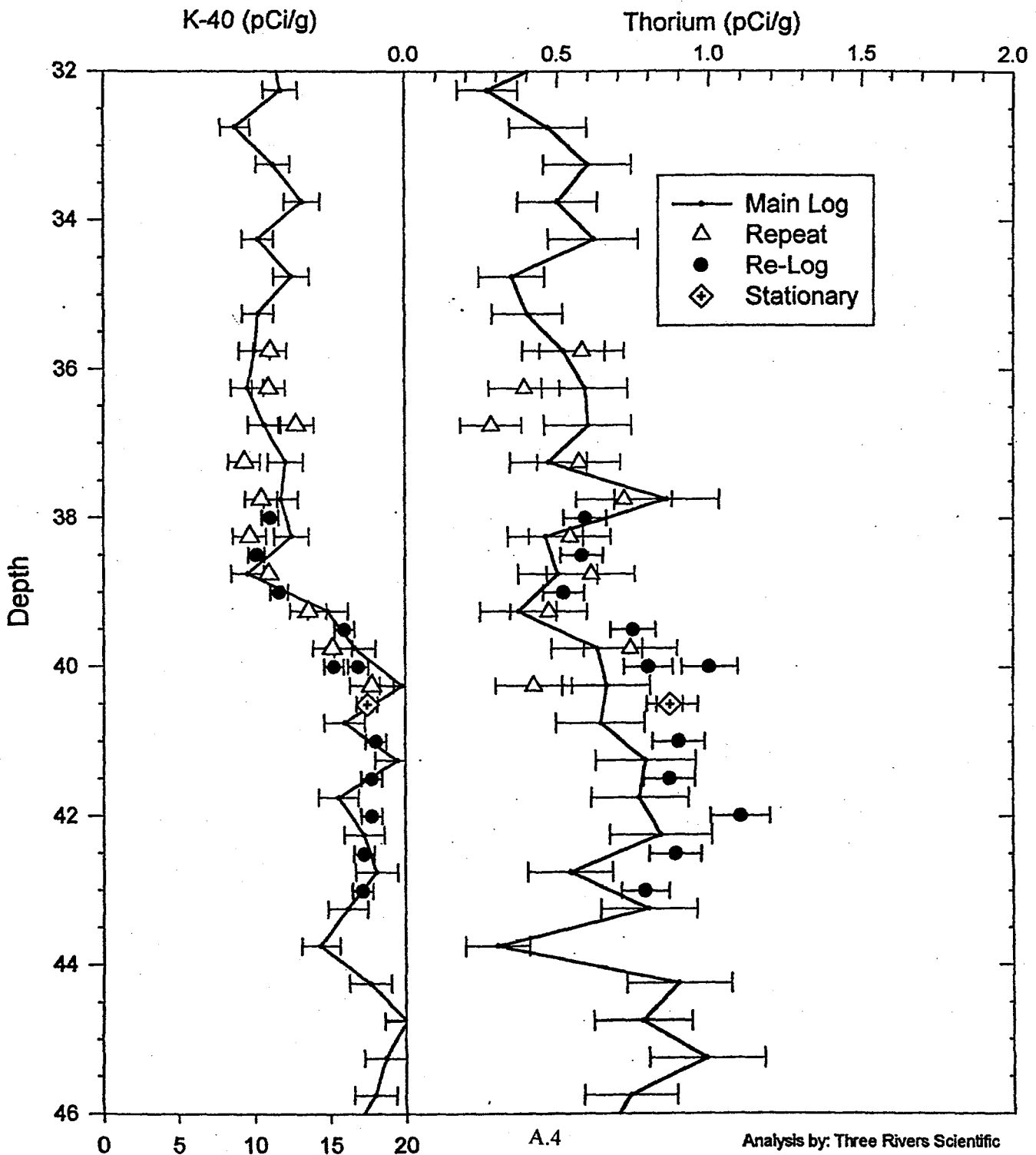
Analysis by: Three Rivers Scientific

# RLS Spectral Gamma Ray Borehole Survey

## Acceptance QA Processing

Project: Z Crib Geophysics  
 Borehole: 299-W15-82

Log Date: Apr. 6 & 8, 1998  
 Compare Main Log, Repeat, Re-Log



Analysis by: Three Rivers Scientific

**RLS Spectral Gamma Ray Borehole Survey**  
Waste Management Federal Services NW

**Log Analysis Summary Report**

Project: Z Crib Geophysics  
Log Type: HPGe Spectral Gamma-Ray

Well ID: 299-W15-82  
Log Dates: Apr. 6&8, 1998

**General Notes:**

Total gamma is, in general, a response to formation lithology.

**System Performance Verification:** The pre- and post-log verification was performed using coleman #2 mantle. The maximum FWHM for the 583 keV gamma ray photo peak for both survey dates was 2.72 keV. The maximum acceptable FWHM resolution is 3.10 keV for probe RLSG3.1 on the log dates.

**Repeat Interval:** The repeat interval, 35.7 to 40.2 feet, agrees with the main log within acceptable limits (refer to the Acceptance QA Processing plot). Since no man-made radionuclides were detected, the repeat for the most precise man-made component was replaced with the natural thorium response.

**Environmental Corrections:** The KUT concentrations have been corrected for casing attenuation over the entire well. No casing correction was applied to the total gamma due to Compton downscatter interference.

**Radionuclides:**

No man-made radionuclides were detected.

**RLS Spectral Gamma Ray Borehole Survey**  
**Waste Management Federal Services NW**

**Log Header**

Project: Z Crib Geophysics

Well: 299-W15-84

Log Type: HPGe Spectral Gamma Ray

**Borehole Information**

Well ID	<u>A7384</u>	Water Depth	<u>No Data</u>	Total Depth	<u>110</u> ft
Elevation Reference	<u>No Data</u>	Elevation	<u>No Data</u> ft		
Depth Reference	<u>Top of Casing</u>	Casing Stickup	<u>1.28</u> ft		
Casing Diameter	<u>8</u> in ID	Depth Interval	<u>0 to 110</u> ft	Thickness	<u>0.24</u> in
Casing Diameter	<u>    </u> in	Depth Interval	<u>    </u> ft	Thickness	<u>    </u> in

**Logging Information**

Log Type	HPGe Spectral Gamma Ray		
Company	Waste Management Federal Services NW		
Date/Archive File Name	Apr. 6&8, 1998	H2W15084	
Logging Engineers	R. Wilson		
Instrument Series	RLSG3.1		
Logging Unit	RLS2		
Depth Interval	1.5 to 106.5 ft	Prefix B197	
	39 to 44 ft	Prefix B201	
Instrument Calibration Date	Sep. 9, 1997		
Calibration Report	WHC-SD-EN-TI-292, Rev. 0		

**Analysis Information**

Company	Three Rivers Scientific
Analyst	Russ Randall
Date	April 10, 1998

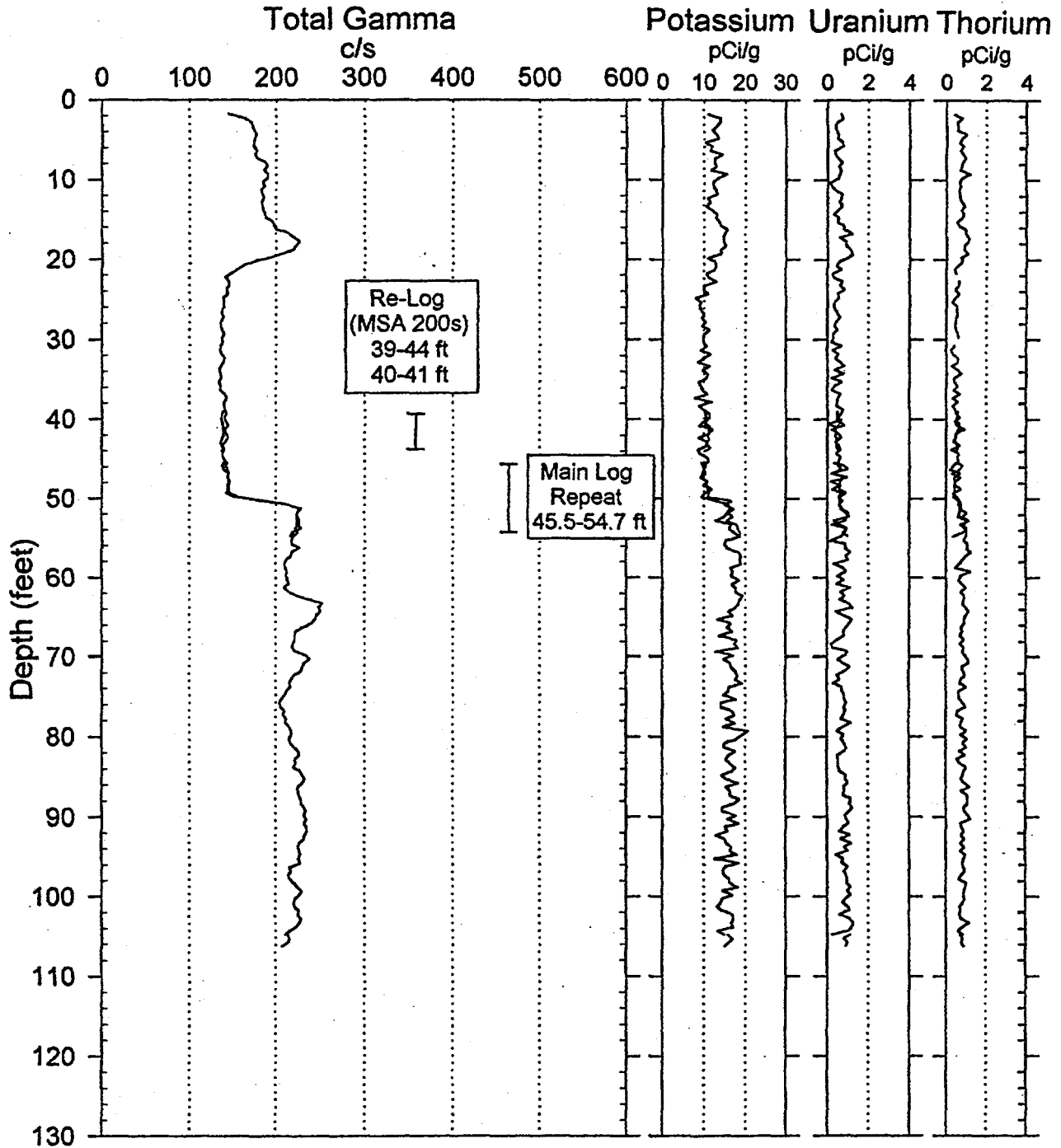
Notes No man-made radionuclides observed. Therefore, no plot for man-made gamma ray emitters, and the repeat plot covers both potassium and thorium.

# RLS Spectral Gamma Ray Borehole Survey

## Waste Management Federal Services NW

Project: Z Crib Geophysics  
Borehole: 299-W15-84

Log Date: Apr. 6 & 8, 1998  
Naturally Occurring Radionuclides

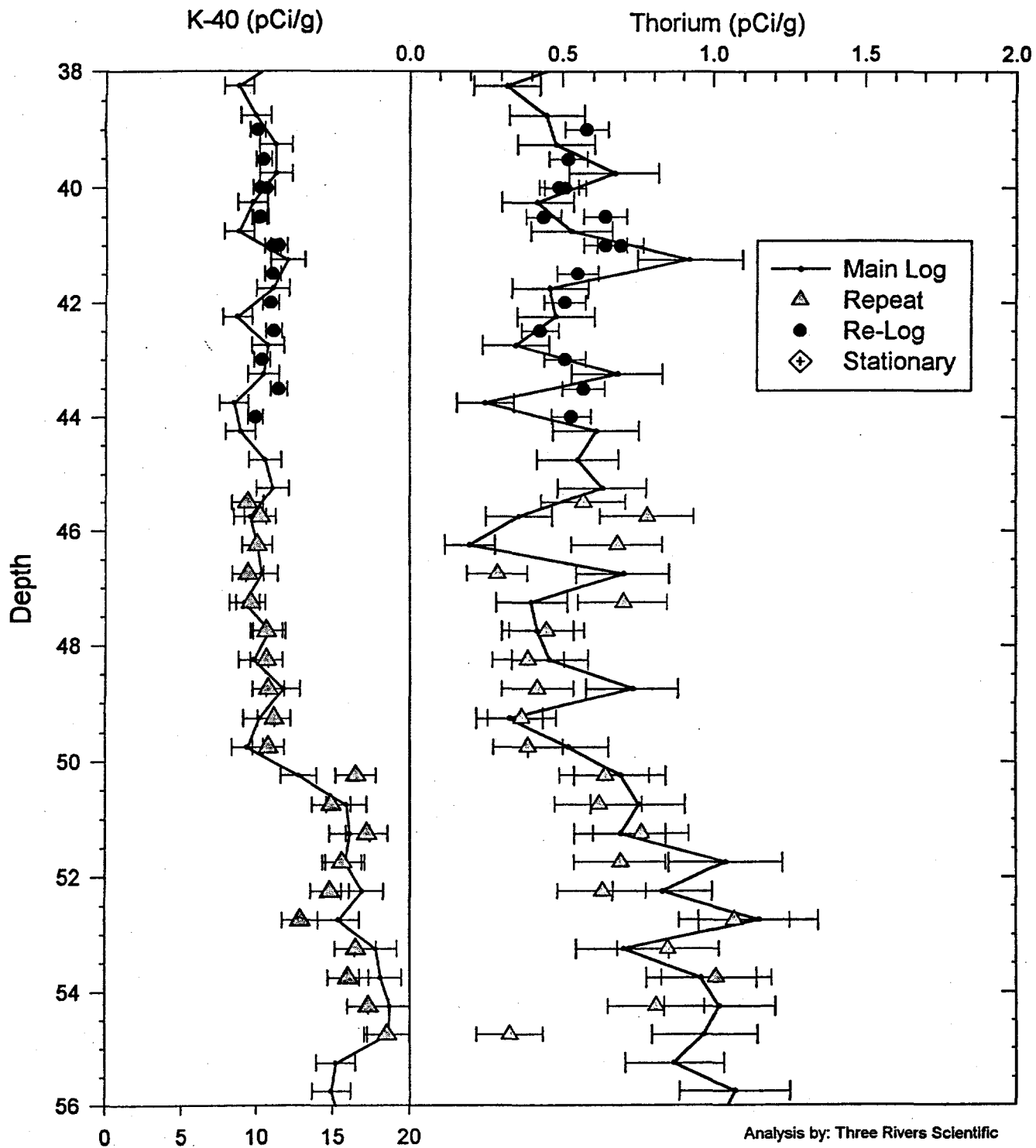


# RLS Spectral Gamma Ray Borehole Survey

## Acceptance QA Processing

Project: Z Crib Geophysics  
Borehole: 299-W15-84

Log Date: Apr. 6 & 8, 1998  
Compare Main Log, Repeat, Re-Log



Analysis by: Three Rivers Scientific

**RLS Spectral Gamma Ray Borehole Survey**  
Waste Management Federal Services NW

**Log Analysis Summary Report**

Project: Z Crib Geophysics  
Log Type: HPGe Spectral Gamma Ray

Well ID: 299-W15-84  
Log Dates: Apr. 6&8, 1998

**General Notes:**

Total gamma is, in general, a response to formation lithology.

**System Performance Verification:** The pre- and post-log verification was performed using coleman #2 mantle. The maximum FWHM for the 583 keV gamma ray photo peak for both survey dates was 2.28 keV. The maximum acceptable FWHM resolution is 3.10 keV for probe RLSG3.1 on the log dates.

**Repeat Interval:** The repeat interval, 45.5 to 54.7 feet, agrees with the main log within acceptable limits (refer to the Acceptance QA Processing plot). Since no man-made radionuclides were detected, the repeat for the most precise man made component was replaced with the natural thorium response.

**Environmental Corrections:** The KUT concentrations have been corrected for casing attenuation over the entire well. No casing correction was applied to the total gamma due to Compton downscatter interference.

**Radionuclides:**

No man-made radionuclides were detected.

# RLS Spectral Gamma Ray Borehole Survey

## Waste Management Federal Services NW

### Log Header

Project: Z Crib Geophysics

Well: 299-W15-85

Log Type: HPGe Spectral Gamma Ray

#### Borehole Information

Well ID	A7385	Water Depth	No Data	Total Depth	106 ft
Elevation Reference	No Data	Elevation	No Data		
Depth Reference	Top of Casing	Casing Stickup	1.56 ft		
Casing Diameter	8 in ID	Depth Interval	0 to 106 ft	Thickness	0.24 in
Casing Diameter	in	Depth Interval	ft	Thickness	in

#### Logging Information

Log Type	HPGe Spectral Gamma Ray	
Company	Waste Management Federal Services NW	
Date/Archive File Name	Apr. 3&7, 1998	H2W15085
Logging Engineers	R. Wilson	J. Meisner
Instrument Series	RLSG3.1	
Logging Unit	RLS2	
Depth Interval	1.5 to 103.5 ft	Prefix B195
	24-26 & 42-47.5	Prefix B199
Instrument Calibration Date	Sep. 9, 1997	
Calibration Report	WHC-SD-EN-TI-292, Rev. 0	

#### Analysis Information

Company	Three Rivers Scientific
Analyst	Russ Randall
Date	April 10, 1998

Notes: No man-made radionuclides observed. Therefore, no plot for man-made gamma ray emitters, and the repeat plot covers both potassium and thorium.

# RLS Spectral Gamma Ray Borehole Survey

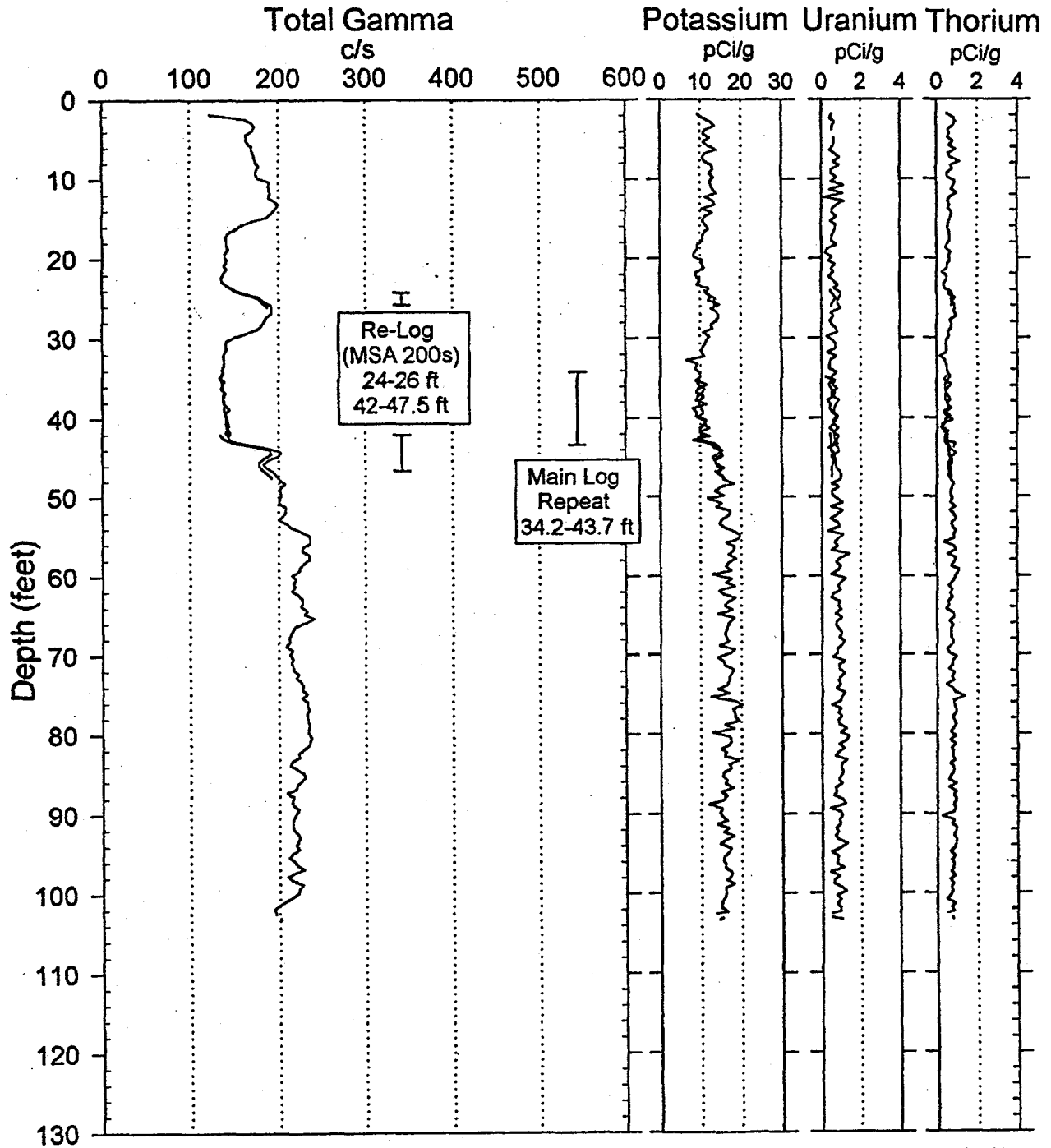
## Waste Management Federal Services NW

Project: Z Crib Geophysics

Log Date: Apr. 3 & 7, 1998

Borehole: 299-W15-85

Naturally Occurring Radionuclides



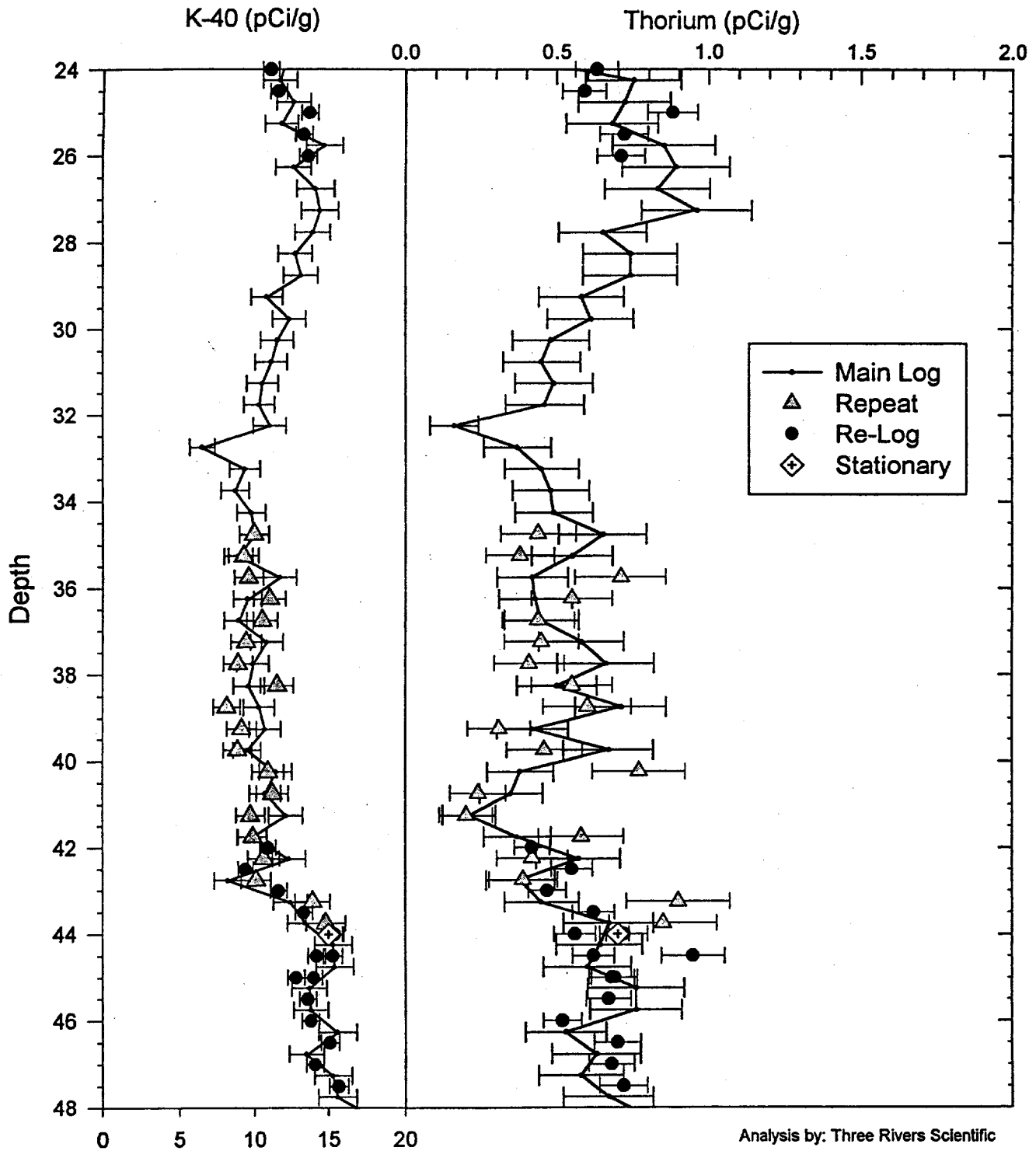
Analysis by: Three Rivers Scientific

# RLS Spectral Gamma Ray Borehole Survey

## Acceptance QA Processing

Project: Z Crib Geophysics  
Borehole: 299-W15-85

Log Date: Apr. 3 & 7, 1998  
Compare Main Log, Repeat, Re-Log



Analysis by: Three Rivers Scientific

**RLS Spectral Gamma Ray Borehole Survey**  
Waste Management Federal Services NW

**Log Analysis Summary Report**

Project: Z Crib Geophysics  
Log Type: HPGe Spectral Gamma-Ray

Well ID: 299-W15-85  
Log Dates: Apr. 3&7, 1998

**General Notes:**

Total gamma is, in general, a response to formation lithology.

**System Performance Verification:** The pre- and post-log verification was performed using coleman #2 mantle. The maximum FWHM for the 583 keV gamma ray photo peak for both survey dates was 2.23 keV. The maximum acceptable FWHM resolution is 3.10 keV for probe RLSG3.1 on the log dates.

**Repeat Interval:** The repeat interval, 34.2 to 43.7 feet, agrees with the main log within acceptable limits, refer to the Acceptance QA Processing plot. Since no man-made radionuclides were detected, the repeat for the most precise man-made component was replaced with the natural thorium response.

**Environmental Corrections:** The KUT concentrations have been corrected for casing attenuation over the entire well. No casing correction was applied to the total gamma due to Compton downscatter interference.

**Radon Pumping:** Low barometric pressure permits free radon-222 in the formation to vent up the borehole, creating additional uranium gamma-ray daughters inside the casing that add to the logging signal. The high apparent uranium concentrations during low barometric pressure vents will not agree with formation gamma ray activity when radon is not venting up boreholes. The re-log of 4/7/1998 compared to the main log of 4/3/1998 demonstrates a small, but noticeable difference in the uranium and subsequently a moderately poor gross gamma log repeat.

**Radionuclides:**

No man-made radionuclides were detected.

**RLS Spectral Gamma Ray Borehole Survey**  
**Waste Management Federal Services NW**

**Log Header**

Project: Z Crib Geophysics

Well: 299-W15-95

Log Type: HPGe Spectral Gamma Ray

**Borehole Information**

Well ID	<u>A7394</u>	Water Depth	<u>None</u>	Total Depth	<u>101</u> ft
Elevation Reference	<u>Ground Level</u>	Elevation	<u>663</u> ft		
Depth Reference	<u>Top of Casing</u>	Casing Stickup	<u>2.62</u> ft		
Casing Diameter	<u>8</u> in ID	Depth Interval	<u>0 to 101</u> ft	Thickness	<u>0.26</u> in
Casing Diameter	<u>   </u> in	Depth Interval	<u>      </u> ft	Thickness	<u>      </u> in

**Logging Information**

Log Type	HPGe Spectral Gamma Ray	
Company	Waste Management Federal Services NW	
Date/Archive File Name	Mar. 28 & Apr. 3, 1998 H2W15095	
Logging Engineers	R. Wilson	
Instrument Series	RLSG3.1	
Logging Unit	RLS2	
Depth Interval	3 to 100 ft	Prefix B188
	39.5 to 47 ft	Prefix B194
Instrument Calibration Date	Sep. 9, 1997	
Calibration Report	WHC-SD-EN-TI-292, Rev. 0	

**Analysis Information**

Company	Three Rivers Scientific
Analyst	Randall Price
Date	April 7, 1998

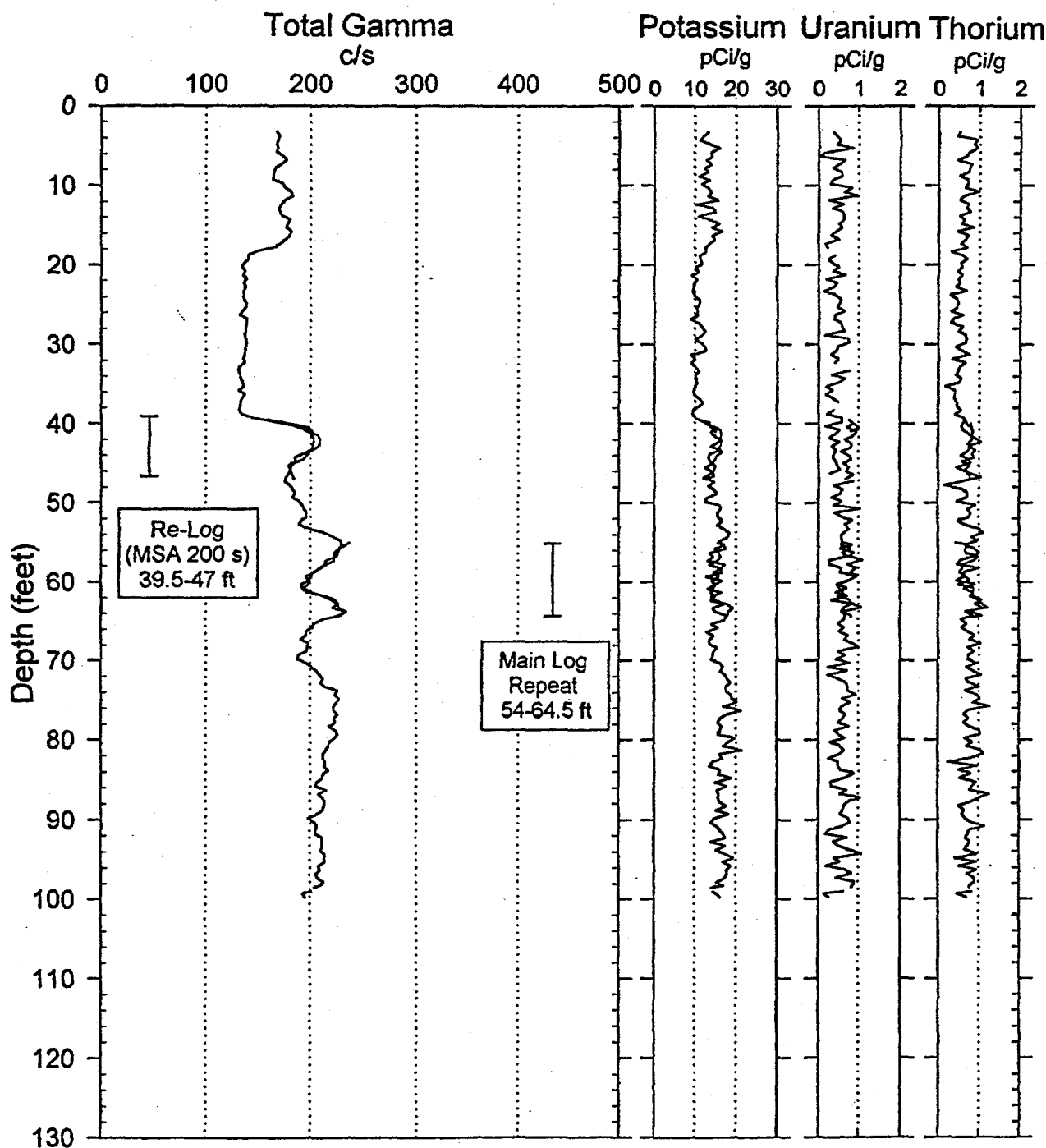
Notes Cs-137 was the only man-made radionuclide identified. Cs-137 exists only at the surface with an apparent concentration of less than 1 pCi/g.

# RLS Spectral Gamma Ray Borehole Survey

## Waste Management Federal Services NW

Project: Z Crib Geophysics  
Borehole: 299-W15-95

Log Date: Mar. 28 & Apr. 3, 1998  
Naturally Occurring Radionuclides



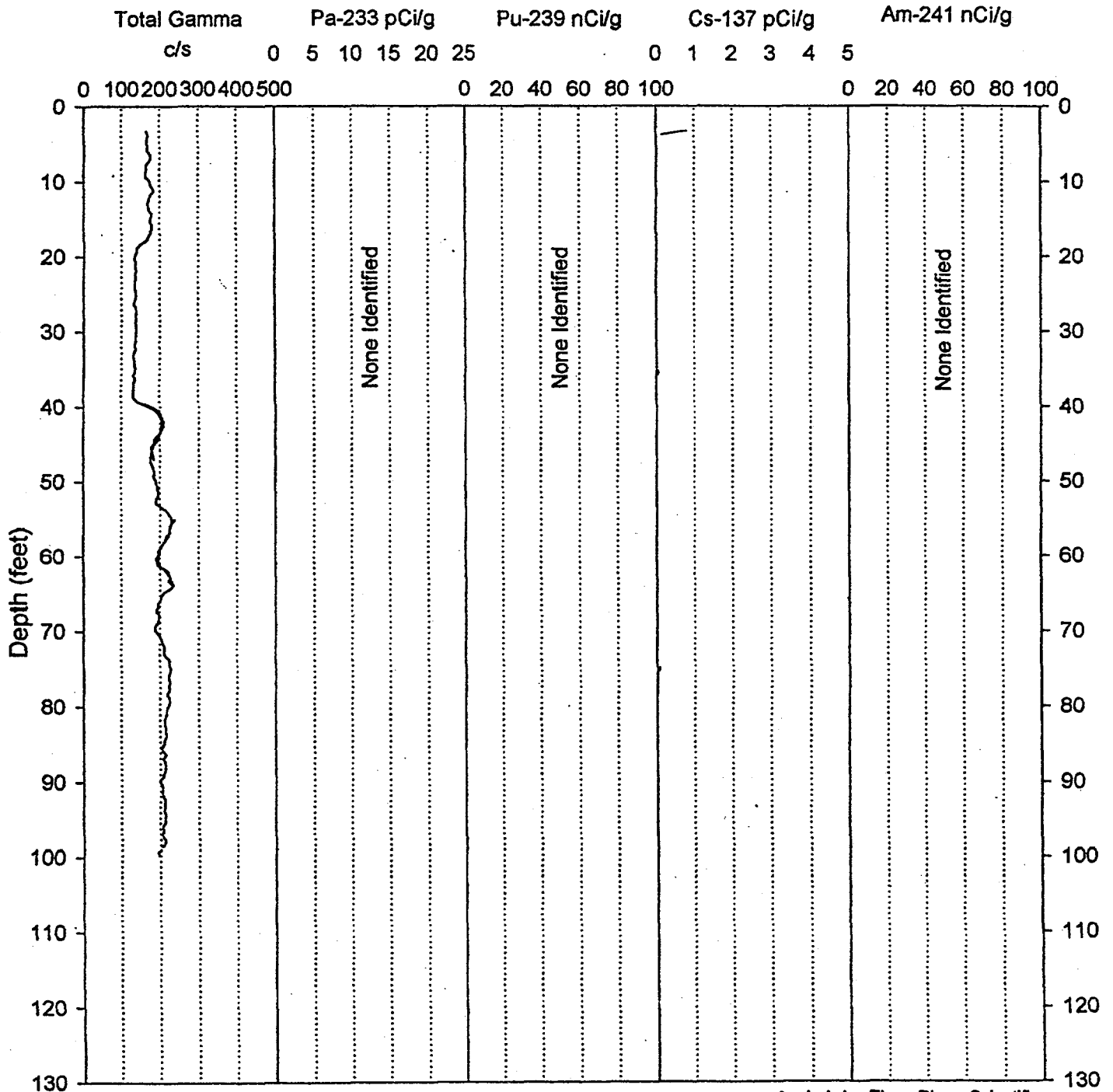
Analysis by: Three Rivers Scientific

# RLS Spectral Gamma Ray Borehole Survey

## Waste Management Federal Services NW

Project: Z Crib Geophysics  
 Borehole: 299-W15-95

Log Date: Mar. 28 & Apr. 3, 1998  
 Man-Made Radionuclides of Concern

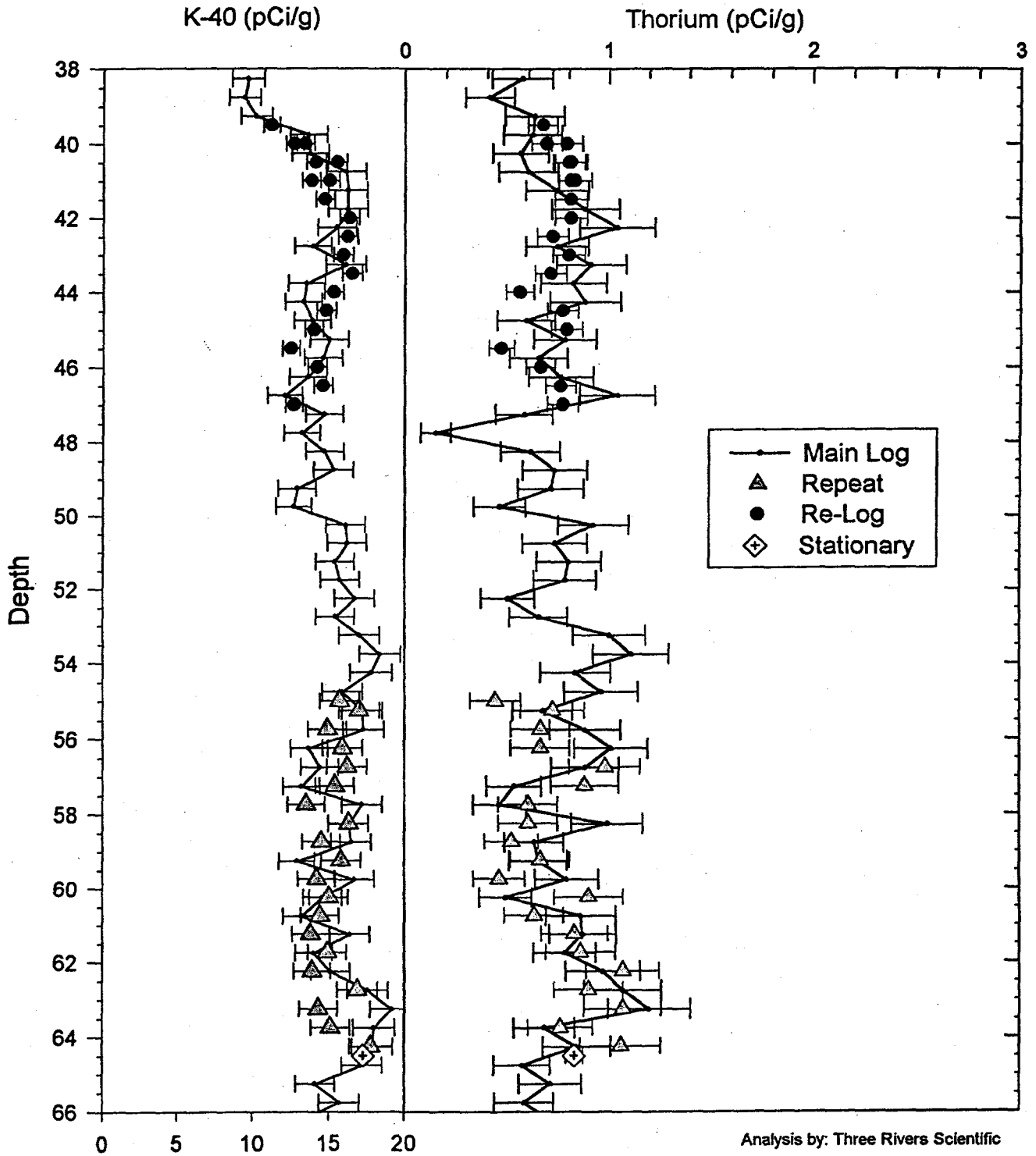


# RLS Spectral Gamma Ray Borehole Survey

## Acceptance QA Processing

Project: Z Crib Geophysics  
Borehole: 299-W15-95

Log Date: Mar. 28 & Apr. 3, 1998  
Compare Main Log, Repeat, Re-Log



**RLS Spectral Gamma Ray Borehole Survey**  
Waste Management Federal Services NW

**Log Analysis Summary Report**

Project: Z Crib Geophysics  
Log Type: HPGe Spectral Gamma Ray

Well ID: 299-W15-95  
Log Dates: Mar. 28 & Apr. 27, 1998

**General Notes:**

Total gamma is a function of formation lithology. An interval of low radioactivity from 20 to 40 feet is possibly due to back-fill from previous excavation activities.

**System Performance Verification:** The pre- and post-log verification was performed using coleman #2. The maximum FWHM for the 583 keV gamma ray photo peak for both survey dates was 2.58 keV. The maximum acceptable FWHM resolution is 3.10 keV for probe RLSG3.1 on the log dates.

**Repeat Interval:** The repeat interval, 54 to 64.5 feet, agrees with the main log within acceptable limits (refer to the Acceptance QA Processing plot).

**Environmental Corrections:** The KUT and man-made radionuclide concentrations have been corrected for casing attenuation over the entire well. No casing correction was applied to the total gamma due to Compton downscatter interference.

**Radionuclides:**

Cs-137 was the only man-made radionuclide identified. Cs-137 exists only near the surface with an apparent concentration of less than 1 pCi/g.

	<b>Cs-137</b>
<b>max. Concentration</b>	< 1 pCi/g @ ground surface
<b>max. Depth at MDL</b>	1 ft
<b>MDL</b>	0.2 pCi/g

# RLS Spectral Gamma Ray Borehole Survey

## Waste Management Federal Services NW

### Log Header

Project: Z Crib Geophysics

Well: 299-W18-008

Log Type: HPGe Spectral Gamma Ray

#### Borehole Information

Well ID	<u>A7525</u>	Water Depth	<u>None</u>	Total Depth	<u>48.5</u>	ft
Elevation Reference	<u>No Data</u>	Elevation	<u>None</u>			ft
Depth Reference	<u>Top of Casing</u>	Casing Stickup	<u>0.1</u>			ft
Casing Diameter	<u>6</u>	Depth Interval	<u>0 to 48.5</u>	Thickness	<u>0.22</u>	in
Casing Diameter	<u>in</u>	Depth Interval	<u>ft</u>	Thickness	<u>in</u>	

#### Logging Information

Log Type	HPGe Spectral Gamma Ray	
Company	Waste Management Federal Services NW	
Date/Archive File Name	Mar. 21, 1998 H2W18008	
Logging Engineers	R. Wilson	
Instrument Series	RLSG3.1	
Logging Unit	RLS2	
Depth Interval	0 to 48.5 ft	Prefix B179
Instrument Calibration Date	Sep. 9, 1997	
Calibration Report	WHC-SD-EN-TI-292, Rev. 0	

#### Analysis Information

Company	Three Rivers Scientific
Analyst	Russ Randall
Date	March 26, 1998

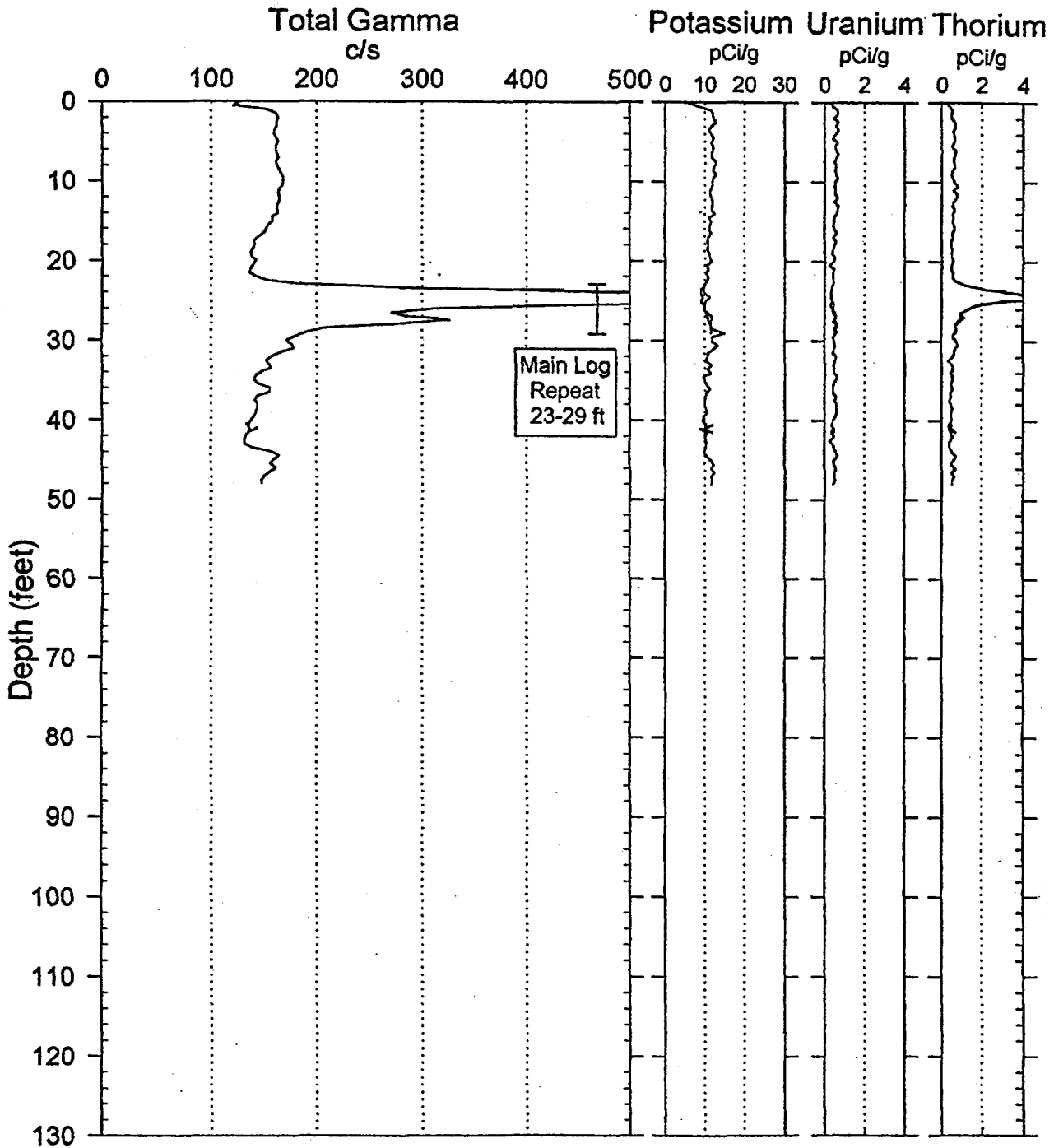
Notes Pa-233 exist from 24 to 36 feet, with a maximum of 57 pCi/g at 24.5 feet. Pu-239 exists from 24 to 28 feet, with a maximum of 58 nCi/g at 24.5 feet. The increase in thorium at 24 feet is not in secular equilibrium, and therefore may be waste by-product. No other man-made radionuclides were detected.

# RLS Spectral Gamma Ray Borehole Survey

## Waste Management Federal Services NW

Project: Z Crib Geophysics  
Borehole: 299-W18-008

Log Date: Mar. 21, 1998  
Naturally Occurring Radionuclides



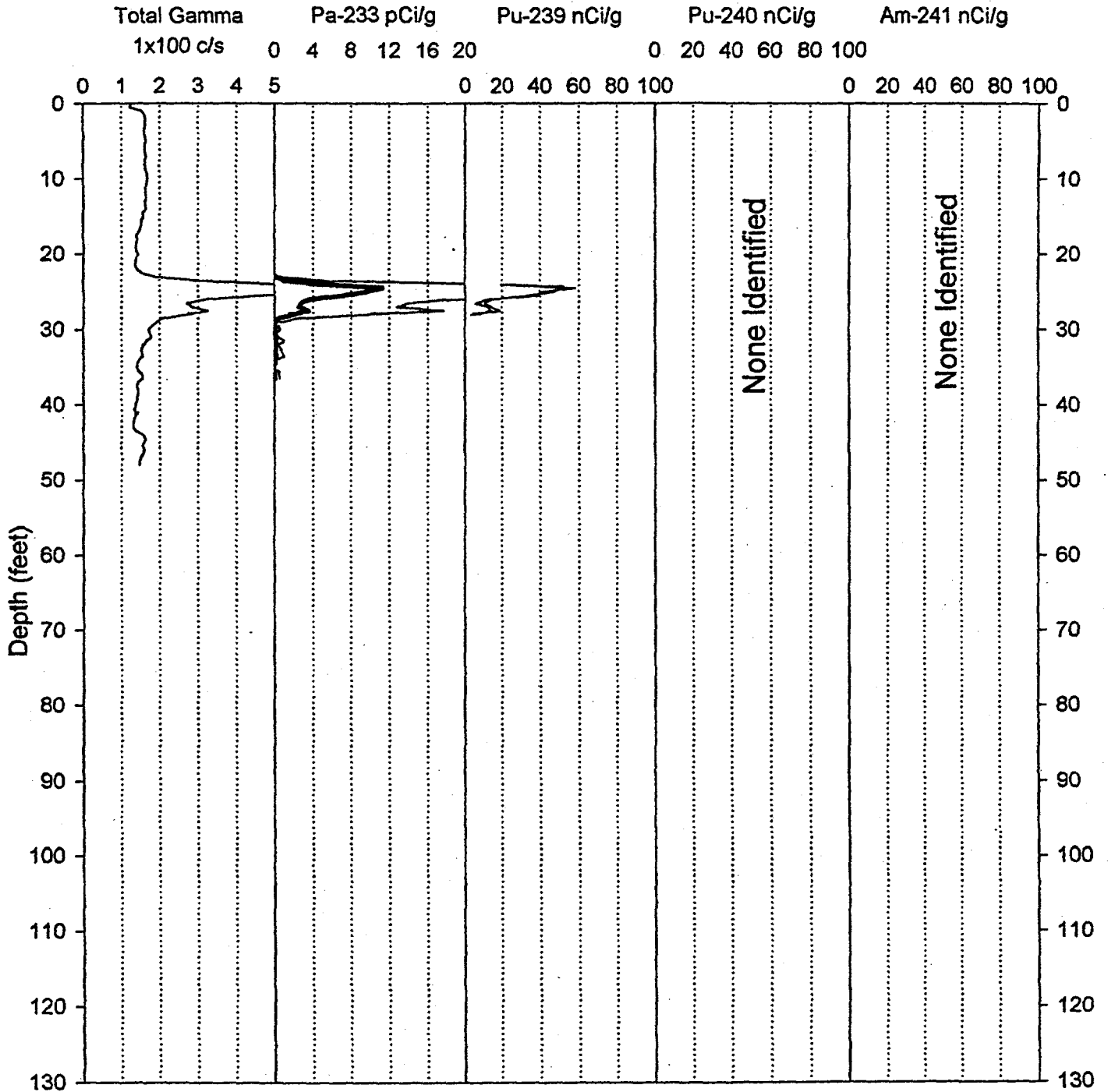
Analysis by: Three Rivers Scientific

# RLS Spectral Gamma Ray Borehole Survey

## Waste Management Federal Services NW

Project: Z Crib Geophysics  
 Borehole: 299-W18-008

Log Date: Mar. 21, 1998  
 Man-Made Radionuclides of Concern



Analysis by: Three Rivers Scientific

0 20 40 60 80 100

A.21

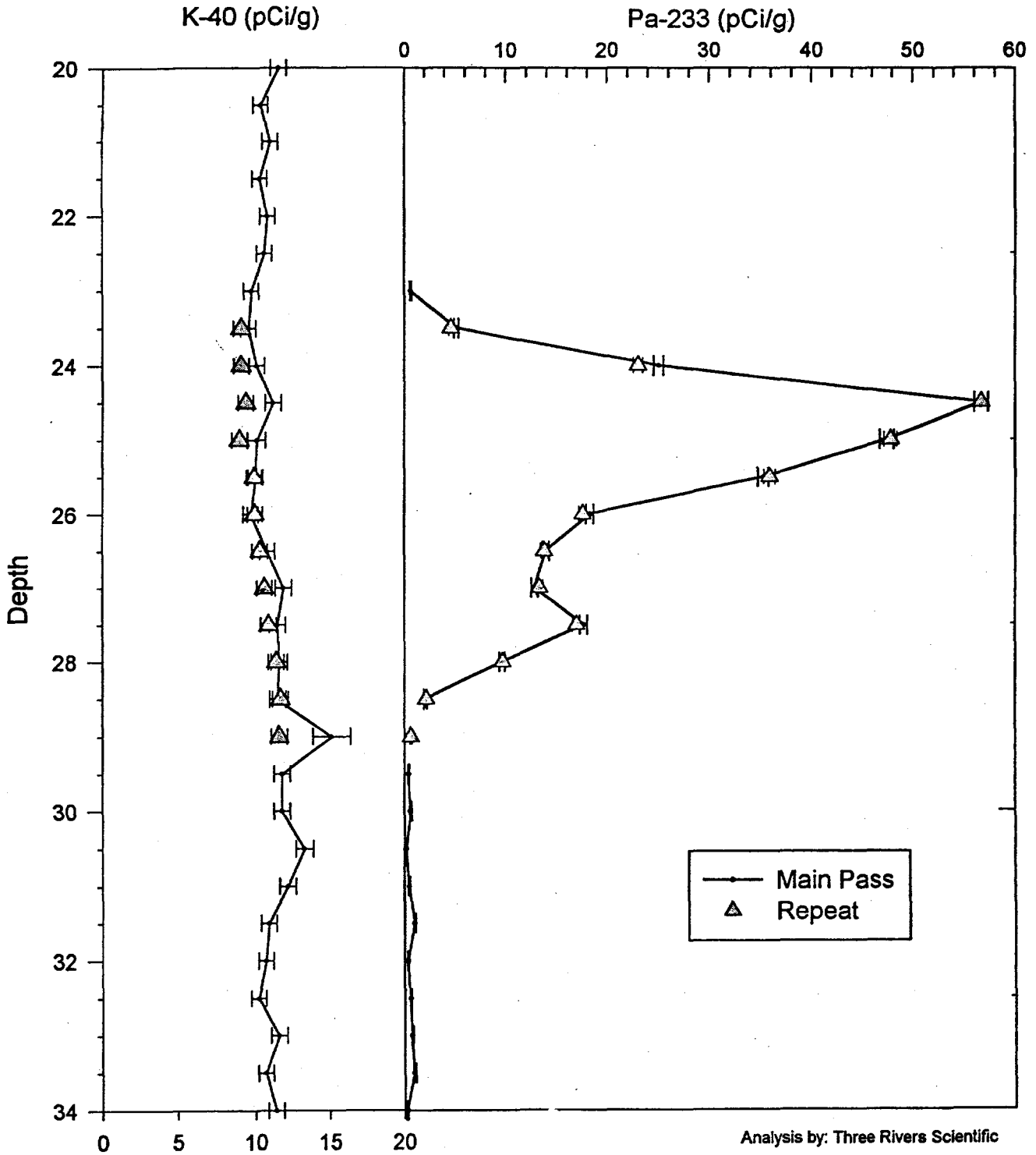
Backup

# RLS Spectral Gamma Ray Borehole Survey

## Acceptance QA Processing

Project: Z Crib Geophysics  
 Borehole: 299-W18-008

Log Date: Mar. 21, 1998  
 Compare Main Log and Repeat



Analysis by: Three Rivers Scientific

# RLS Spectral Gamma Ray Borehole Survey

Waste Management Federal Services NW

## Log Analysis Summary Report

Project: Z Crib Geophysics  
Log Type: HPGe Spectral Gamma-Ray

Well ID: 299-W18-008  
Log Dates: Mar. 21, 1998

### General Notes:

Total gamma is, in general, a response of formation lithology, except at 24 feet, where man-made radionuclides were encountered.

**System Performance Verification:** The pre- and post-log verification was performed using coleman #2 mantle. The maximum FWHM for the 583 keV gamma ray photo peak for the survey was 2.54 keV. The maximum acceptable FWHM resolution is 3.10 keV for probe RLSG3.1 on the log date.

**Repeat Interval:** The repeat interval, 23 to 29 feet, agrees with the main log within acceptable limits (refer to the Acceptance QA Processing plot).

**Environmental Corrections:** The KUT and man-made radionuclide concentrations have been corrected for casing attenuation over the entire well. No casing correction was applied to the total gamma due to Compton downscatter interference. The gross gamma increase at 24 feet is from Tl-208 as well as the man-made radionuclides present. Tl-208 is a daughter product of naturally occurring thorium. However, the secular equilibrium is greatly disturbed, indicating that the thorium is not solely due to natural lithology and may be a waste by-product.

### Radionuclides:

Pa-233 exists from 24 to 36 feet, with a maximum of 57 pCi/g at 24.5 feet. Pu-239 exists from 24 to 28 feet, with a maximum of 58 nCi/g at 24.5 feet.

	Pa-233	Pu-239
max. Concentration	57 pCi/g @ 24.5 ft	58 nCi/g @ 24.5 ft
max. Depth at MDL	36 ft	28 ft
MDL	0.25 pCi/g	8 nCi/g

**RLS Spectral Gamma Ray Borehole Survey**  
**Waste Management Federal Services NW**

**Log Header**

Project: Z Crib Geophysics

Well: 299-W18-149

Log Type: HPGe Spectral Gamma Ray

**Borehole Information**

Well ID	<u>A7649</u>	Water Depth	<u>None</u>	Total Depth	<u>26</u> ft
Elevation Reference	<u>Ground Level</u>	Elevation	<u>N/A</u> ft		
Depth Reference	<u>Top of Casing</u>	Casing Stickup	<u>1.83</u> ft		
Casing Diameter	<u>6</u> in PVC	Depth Interval	<u>0 to 26</u> ft	Thickness	<u>0.28</u> in
Casing Diameter	<u>   </u> in	Depth Interval	<u>      </u> ft	Thickness	<u>      </u> in

**Logging Information**

Log Type	HPGe Spectral Gamma Ray	
Company	Waste Management Federal Services NW	
Date/Archive File Name	Mar. 9, 1998	H2W18149
Logging Engineers	R. Wilson	
Instrument Series	RLSG3.1	
Logging Unit	RLS2	
Depth Interval	0 to 26 ft	Prefix B168
Instrument Calibration Date	Sep. 9, 1997	
Calibration Report	WHC-SD-EN-TI-292, Rev. 0	

**Analysis Information**

Company	Three Rivers Scientific
Analyst	Randall Price
Date	March 25, 1998

Notes Pa-233 exists from 7 to 26 feet, with a maximum of 20 pCi/g at 12.5 feet. Pu-239 exists from 6 to 26 feet, with a maximum of 8,400 nCi/g at 12 feet. Am-241 exists from 6.5 to 26 feet, with a maximum of 900 nCi/g at 12.5 feet. A moderate amount of photo peak interference results in only a relative concentration for Am-241. Cs-137 exists from 6.5 to 26 feet, with a maximum of 11 pCi/g at 12 feet. Pu-240 is also likely, but the interference rules out any possibility of quantification. No other man-made radionuclides were detected, however, many other fission and neutron induced gamma rays are present.

# RLS Spectral Gamma Ray Borehole Survey

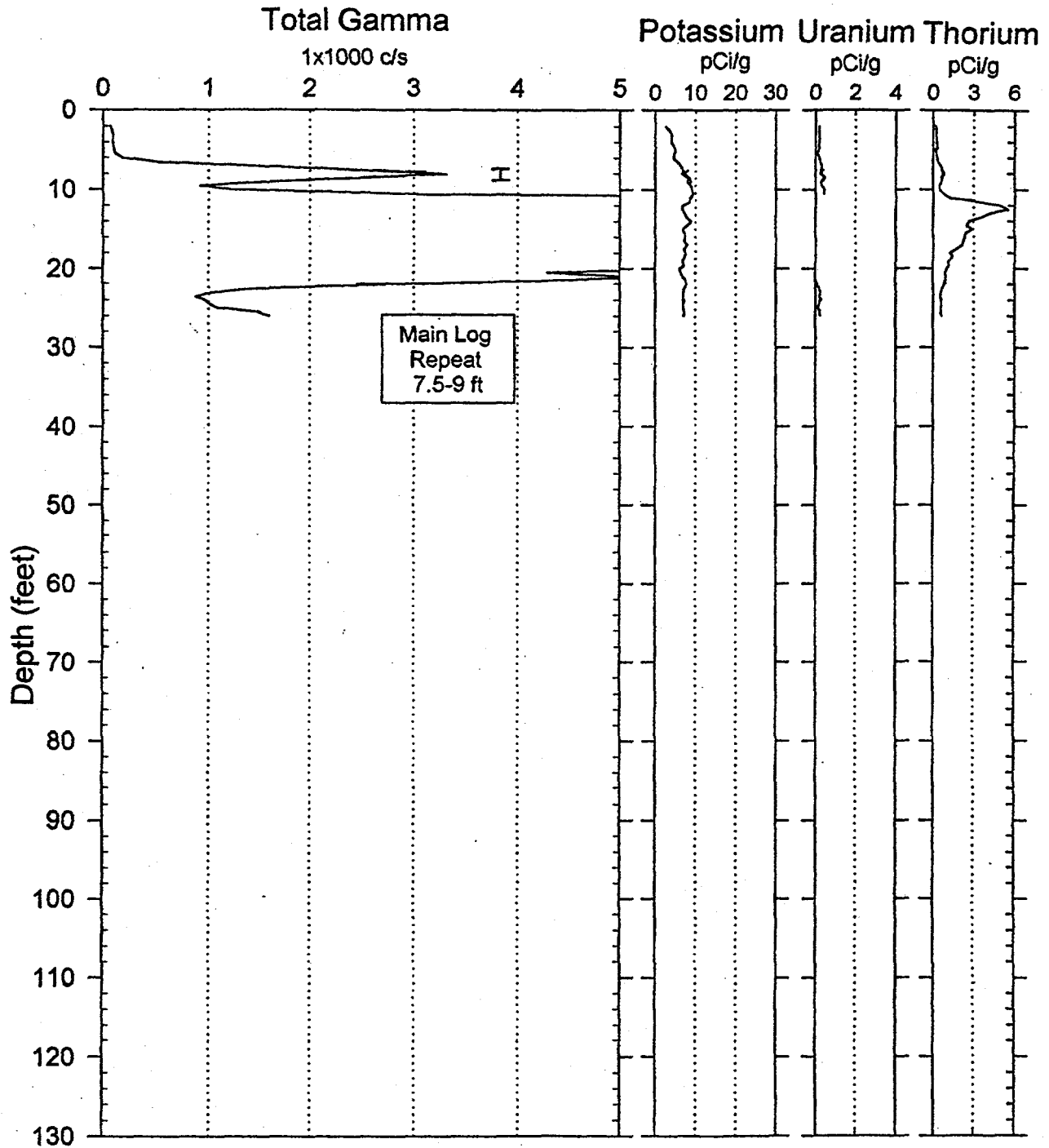
## Waste Management Federal Services NW

Project: Z Crib Geophysics

Log Date: Mar. 9, 1998

Borehole: 299-W18-149

Naturally Occurring Radionuclides



Analysis by: Three Rivers Scientific

# RLS Spectral Gamma Ray Borehole Survey

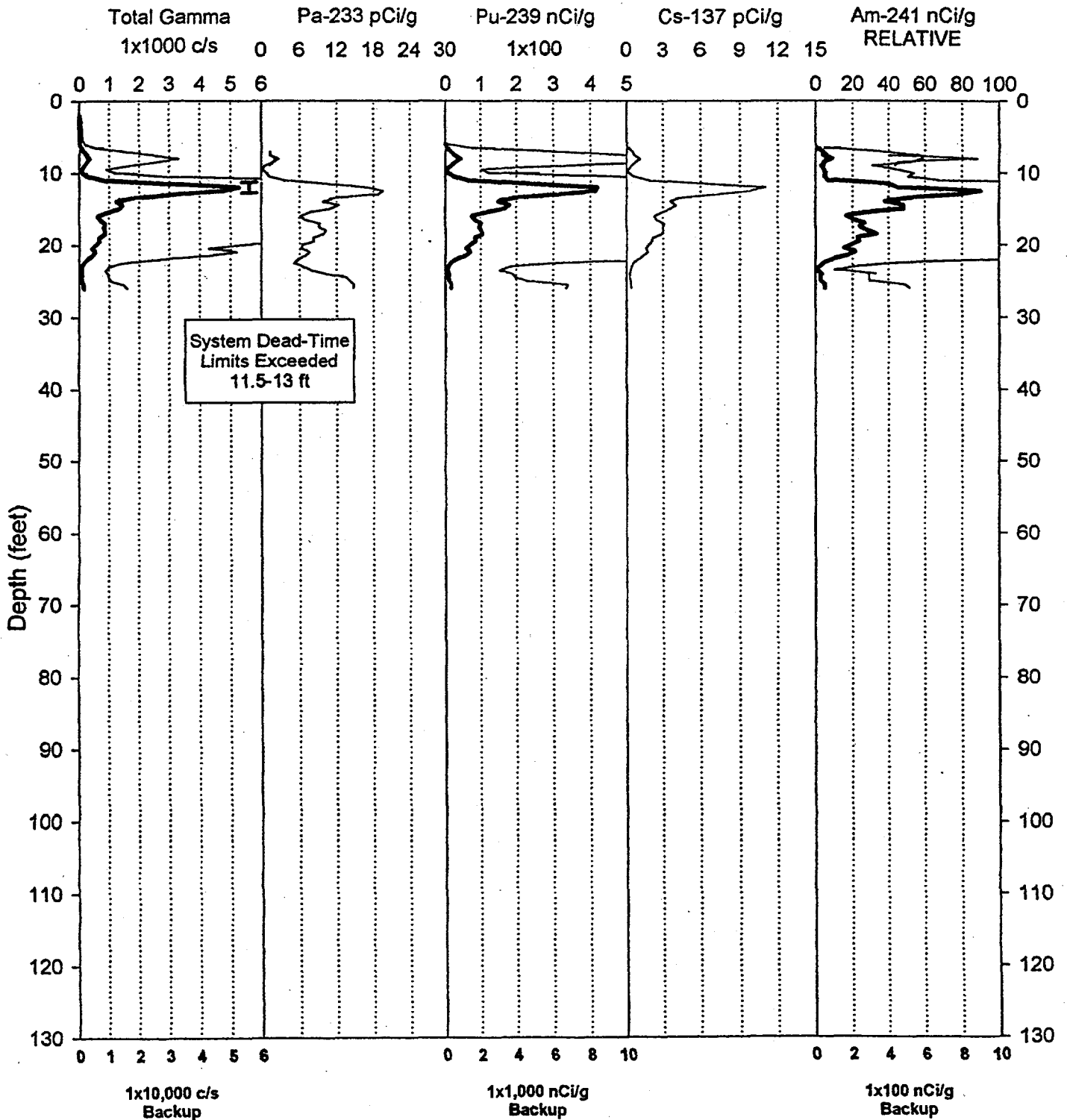
Waste Management Federal Services NW

Project: Z Crib Geophysics

Log Date: Mar. 9, 1998

Borehole: 299-W18-149

Man-Made Radionuclides of Concern

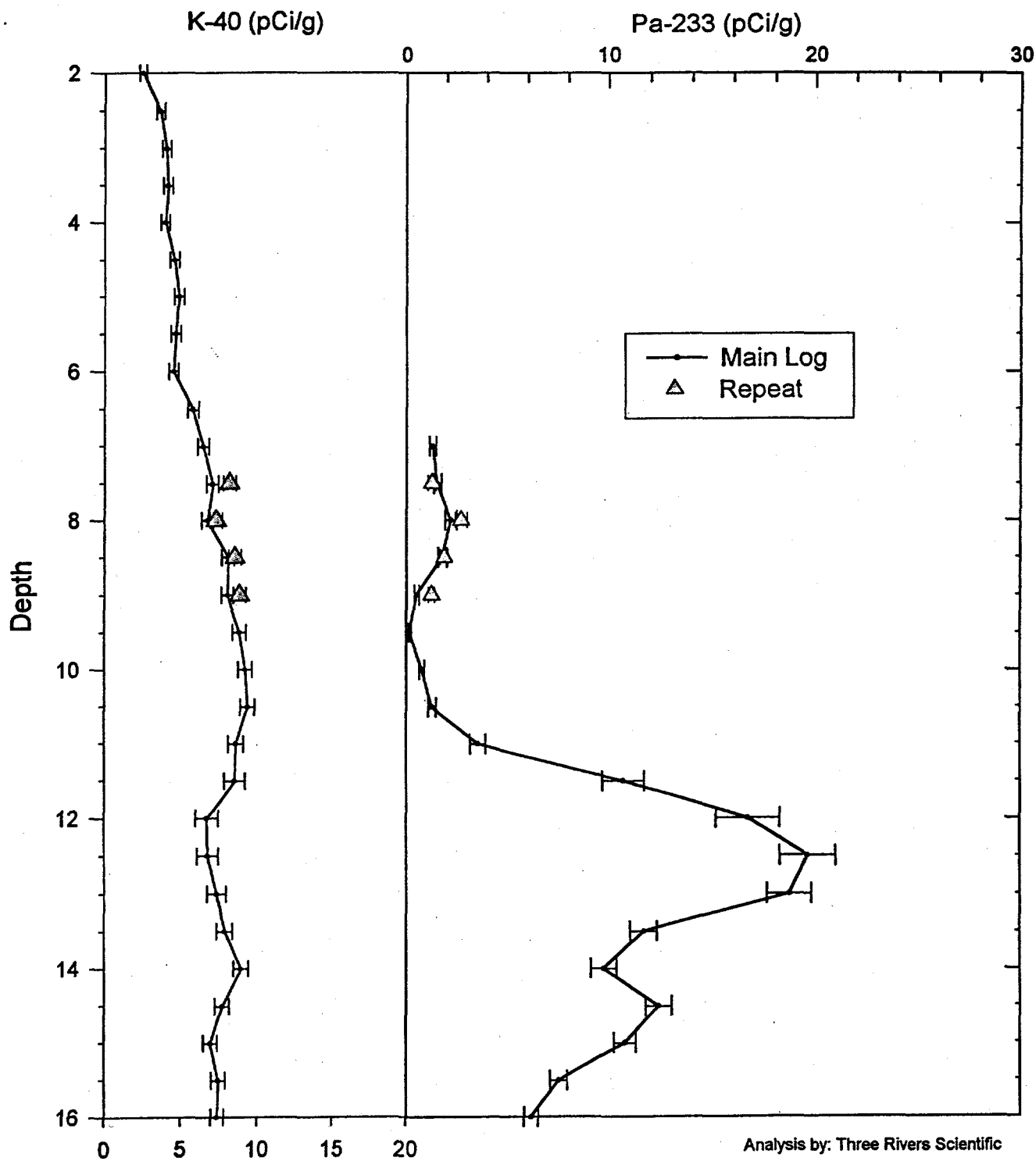


# RLS Spectral Gamma Ray Borehole Survey

## Acceptance QA Processing

Project: Z Crib Geophysics  
Borehole: 299-W18-149

Log Date: Mar. 23 & 27, 1998  
Compare Main Log, Repeat



Analysis by: Three Rivers Scientific

**RLS Spectral Gamma Ray Borehole Survey**  
Waste Management Federal Services NW

**Log Analysis Summary Report**

Project: Z Crib Geophysics  
Log Type: HPGe Spectral Gamma-Ray

Well ID: 299-W18-149  
Log Dates: Mar. 9, 1998

**General Notes:**

Total gamma is a response to man-made gamma-ray emitters from surface to the maximum survey depth of 26 feet.

**System Performance Verification:** The pre- and post-log verification was performed using coleman #2 mantle. The maximum FWHM for the 583 keV gamma ray photo peak was 2.19 keV. The maximum acceptable FWHM resolution is 3.10 keV for probe RLSG3.1 on the log date.

**Repeat Interval:** The repeat interval, 7.5 to 9 ft, agrees with the main log within acceptable limits (refer to the Acceptance QA Processing plot).

**Environmental Corrections:** The KUT and man-made radionuclide concentrations have been corrected for PVC casing attenuation over the entire well however slight. No casing correction was applied to the total gamma due to Compton downscatter interference. The thorium from 8 to 23 feet is from Tl-208, normally a daughter product of naturally occurring thorium; however, the secular equilibrium is greatly disturbed, indicating that the thorium is not solely due to natural lithology and may be a waste by-product.

**Radionuclides:**

Pa-233 exists from 7 to 26 feet, with a maximum of 20 pCi/g at 12.5 feet. Pu-239 exists from 6 to 26 feet, with a maximum of 8,400 nCi/g at 12 feet. Am-241 exists from 6.5 to 26 feet, with a maximum of 900 nCi/g at 12.5 feet. A moderate amount of photo peak interference results in a relative concentration for Am-241. Cs-137 exists from 6.5 to 26 feet, with a maximum of 11 pCi/g at 12 feet. Pu-240 is also likely, but severe photo peak interference rules out any possibility of quantification. No other man-made radionuclides were detected; however, many other fission and neutron induced gamma rays are present.

The system dead-time limit was exceeded between 11.5 and 13 ft which prevented accurate measurement of the radionuclide concentrations, and all concentrations listed in this interval are relative.

The bottom of the borehole was encountered before the MDL values were recorded. Thus the MDL values are estimated from other sections of the well log data.

	<b>Pa-233</b>	<b>Pu-239</b>	<b>Cs-137</b>	<b>Am-241</b>
<b>max. Concentration</b>	20 pCi/g @12.5 ft	8400 nCi/g @ 112 ft	11 pCi/g @ 12 ft	900 nCi/g @ 12.5 ft
<b>max. Depth at MDL</b>	Below Total Depth	Below Total Depth	Below Total Depth	Below Total Depth
<b>MDL</b>	1 pCi/g	7 nCi/g	0.1 pCi/g	10 nCi/g

# RLS Spectral Gamma Ray Borehole Survey

## Waste Management Federal Services NW

### Log Header

Project: Z Crib Geophysics

Well: 299-W18-152

Log Type: HPGe Spectral Gamma Ray

#### Borehole Information

Well ID	<u>A7635</u>	Water Depth	<u>None</u>	Total Depth	<u>118</u> ft
Elevation Reference	<u>Ground Level</u>	Elevation	<u>684.0</u> ft		
Depth Reference	<u>Top of Casing</u>	Casing Stickup	<u>2.75</u> ft		
Casing Diameter	<u>8</u> in ID	Depth Interval	<u>0 to 118</u> ft	Thickness	<u>0.28</u> in
Casing Diameter	<u>  </u> in	Depth Interval	<u>          </u> ft	Thickness	<u>          </u> in

#### Logging Information

Log Type	HPGe Spectral Gamma Ray	
Company	Waste Management Federal Services NW	
Date/Archive File Name	Mar. 12&17, 1998	H2W18152
Logging Engineers	R. Wilson	
Instrument Series	RLSG3.1	
Logging Unit	RLS2	
Depth Interval	0 to 117.6 ft	Prefix B167
	24.5 to 32.5 ft	Prefix B174
Instrument Calibration Date	Sep. 9, 1997	
Calibration Report	WHC-SD-EN-TI-292, Rev. 0	

#### Analysis Information

Company	Three Rivers Scientific
Analyst	Randall Price
Date	March 23, 1998

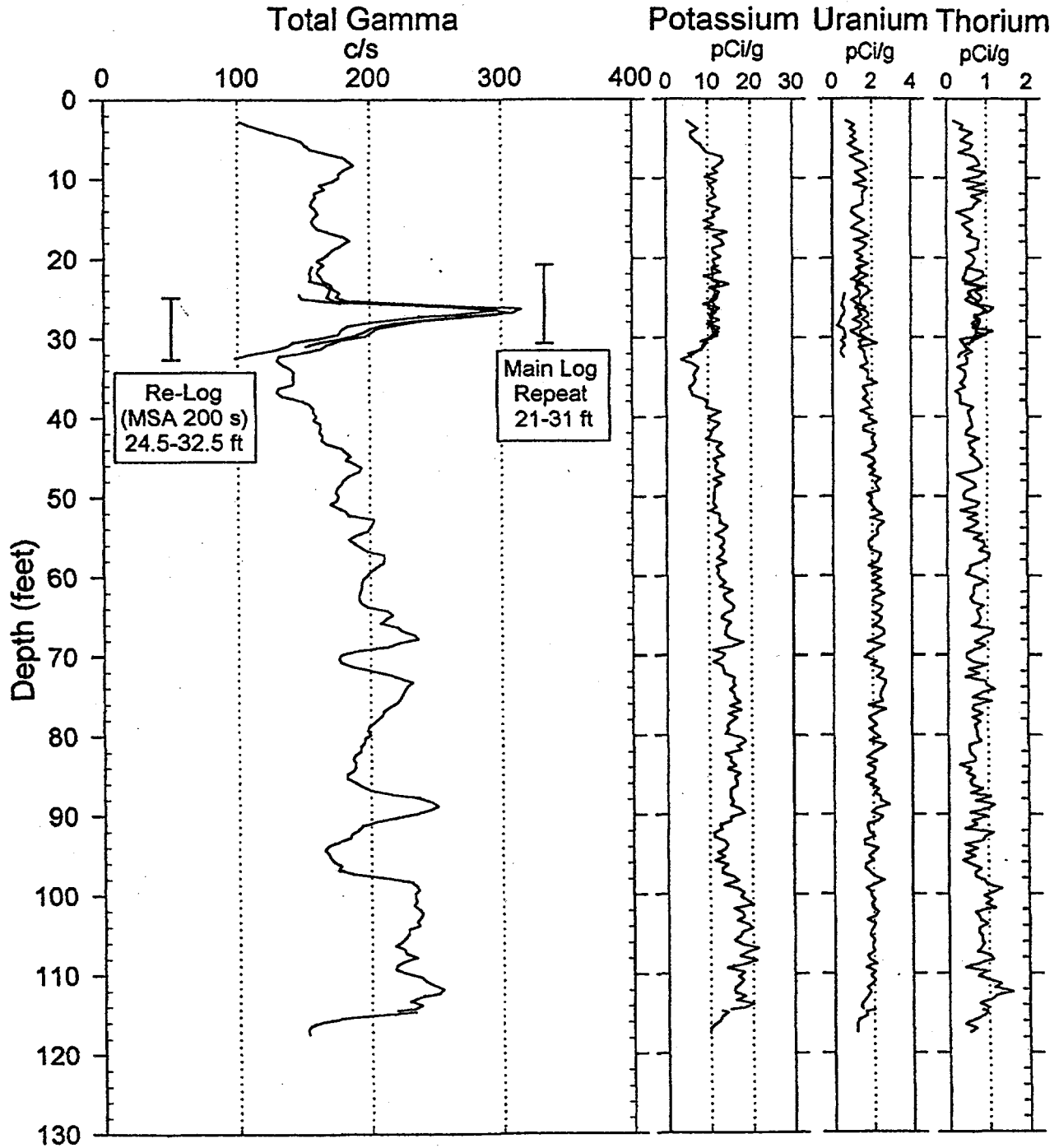
Notes Pa-233 was identified from 25 to 30 feet, with a maximum of 16 pCi/g at 26.5 feet.

# RLS Spectral Gamma Ray Borehole Survey

## Waste Management Federal Services NW

Project: Z Crib Geophysics  
 Borehole: 299-W18-152

Log Date: Mar. 12&17, 1998  
 Naturally Occurring Radionuclides



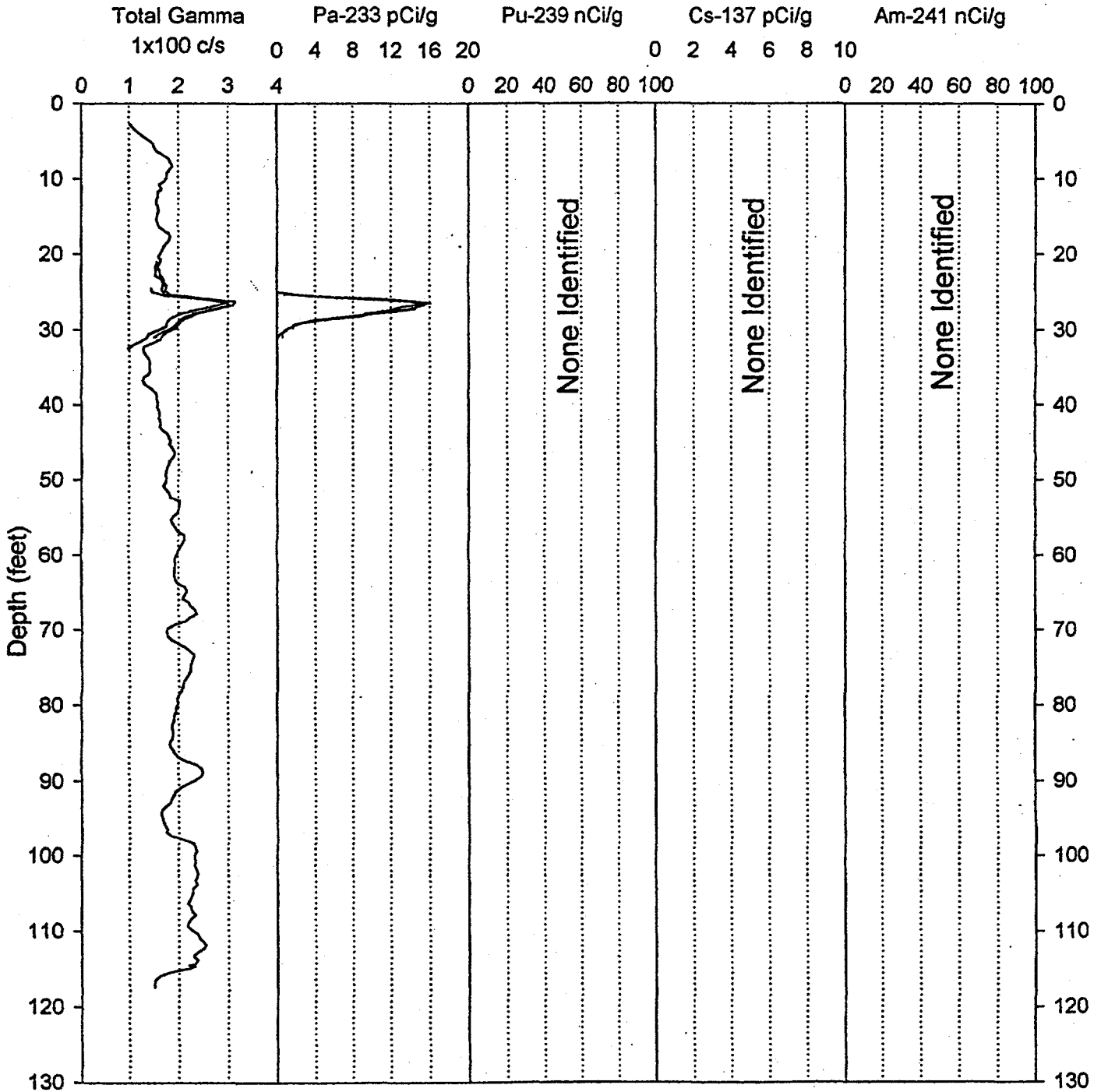
Analysis by: Three Rivers Scientific

# RLS Spectral Gamma Ray Borehole Survey

## Waste Management Federal Services NW

Project: Z Crib Geophysics  
Borehole: 299-W18-152

Log Date: Mar. 12&17, 1998  
Man-Made Radionuclides of Concern

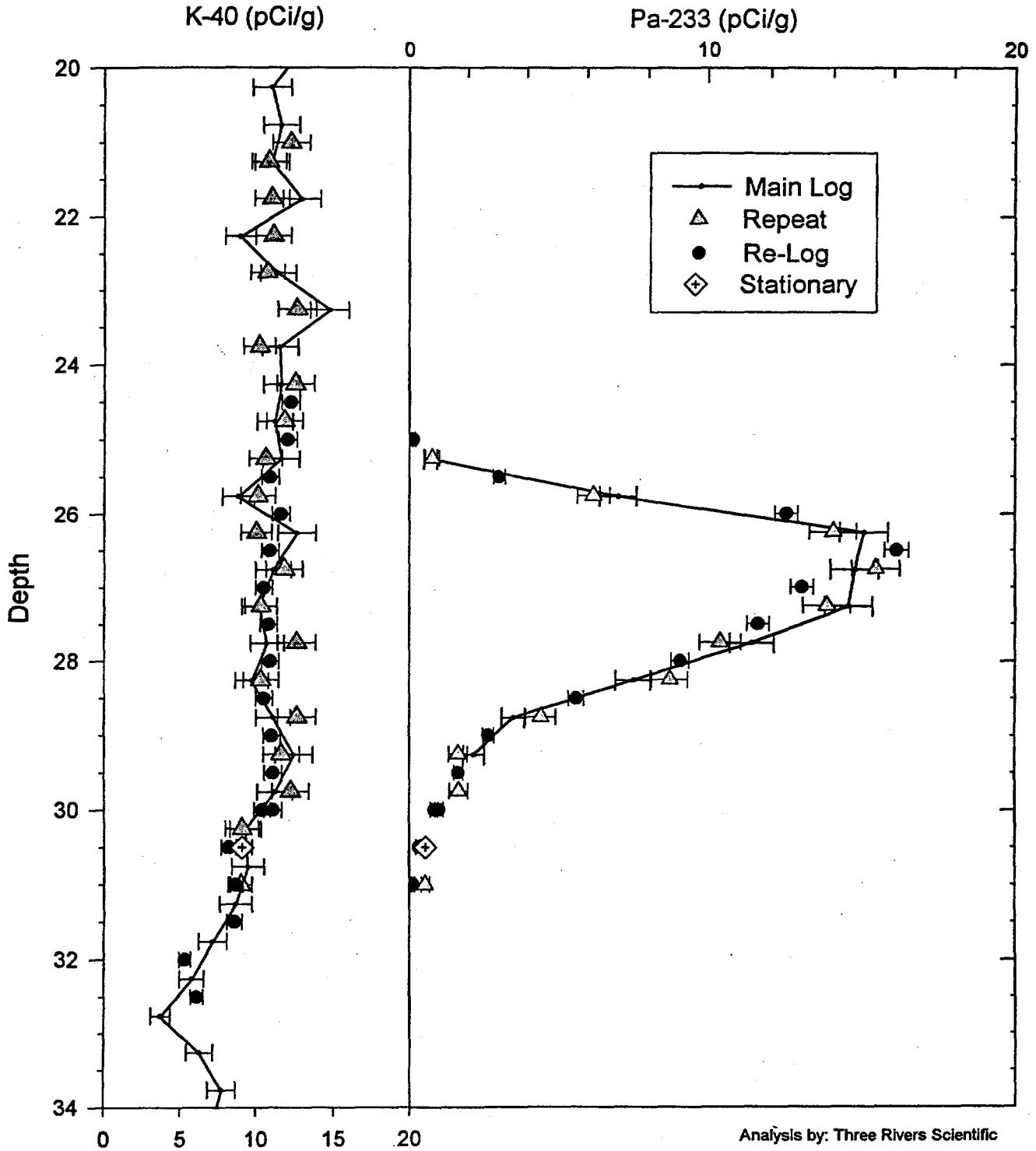


# RLS Spectral Gamma Ray Borehole Survey

## Acceptance QA Processing

Project: Z Crib Geophysics  
Borehole: 299-W18-152

Log Date: Mar. 12&17, 1998  
Compare Main Log, Repeat, Re-Log



Analysis by: Three Rivers Scientific

# RLS Spectral Gamma Ray Borehole Survey

Waste Management Federal Services NW

## Log Analysis Summary Report

Project: Z Crib Geophysics  
Log Type: HPGe Spectral Gamma-Ray

Well ID: 299-W18-152  
Log Dates: Mar. 12&17, 1998

### General Notes:

Total gamma is, in general, a response of formation lithology, except 24 to 30 ft where man made radionuclides were encountered.

**System Performance Verification:** The pre- and post-log verification was performed using coleman #2 mantle. The maximum FWHM for the 583 KeV gamma ray photo peak for both survey dates was 2.21 KeV. The maximum acceptable FWHM resolution is 3.10 KeV for probe RLSG3.1.

**Repeat Interval:** The repeat interval, 21 to 31 ft, agrees with the main log within acceptable limits (refer to the Acceptance QA Processing plot).

**Environmental Corrections:** The KUT and man-made radionuclide concentrations have been corrected for casing attenuation over the entire well. No casing correction was applied to the total gamma due to Compton downscatter interference.

**Radon Pumping:** Low barometric pressure permits free radon-222 in the formation to vent up the borehole, creating additional uranium gamma-ray daughters inside the casing that add to the formation signal. The high apparent uranium concentrations during low barometric pressure vents will not agree with formation gamma-ray activity when radon is not venting up boreholes. The re-log of 3/17/1998 agrees with the main log of 3/12/1998 with all radionuclides except uranium (radon-222) and the radon-222 contribution to total gamma.

### Radionuclides:

Pa-233 exists from 25 to 31 ft, with a maximum of 16 pCi/g at 26.5 ft.

	<b>Pa-233</b>
<b>max. Concentration</b>	16 pCi/g @ 26.5 ft
<b>max. Depth at MDL</b>	30.5 ft
<b>MDL</b>	0.4 pCi/g

# RLS Spectral Gamma Ray Borehole Survey

## Waste Management Federal Services NW

### Log Header

Project: Z Crib Geophysics

Well: 299-W18-153

Log Type: HPGe Spectral Gamma Ray

#### Borehole Information

Well ID	A7636	Water Depth	None	Total Depth	107 ft
Elevation Reference	Ground Level	Elevation	682 ft		
Depth Reference	Top of Casing	Casing Stickup	2.88 ft		
Casing Diameter	8 in ID	Depth Interval	0 to 107 ft	Thickness	0.28 in
Casing Diameter	in	Depth Interval	ft	Thickness	in

#### Logging Information

Log Type	HPGe Spectral Gamma Ray	
Company	Waste Management Federal Services NW	
Date/Archive File Name	Mar. 23&27, 1998	H2W18153
Logging Engineers	R. Wilson	
Instrument Series	RLSG3.1	
Logging Unit	RLS2	
Depth Interval	0 to 106.5 ft	Prefix B180
	25 to 31.5 ft	Prefix B186
Instrument Calibration Date	Sep. 9, 1997	
Calibration Report	WHC-SD-EN-TI-292, Rev. 0	

#### Analysis Information

Company	Three Rivers Scientific
Analyst	Randall Price
Date	April 6, 1998

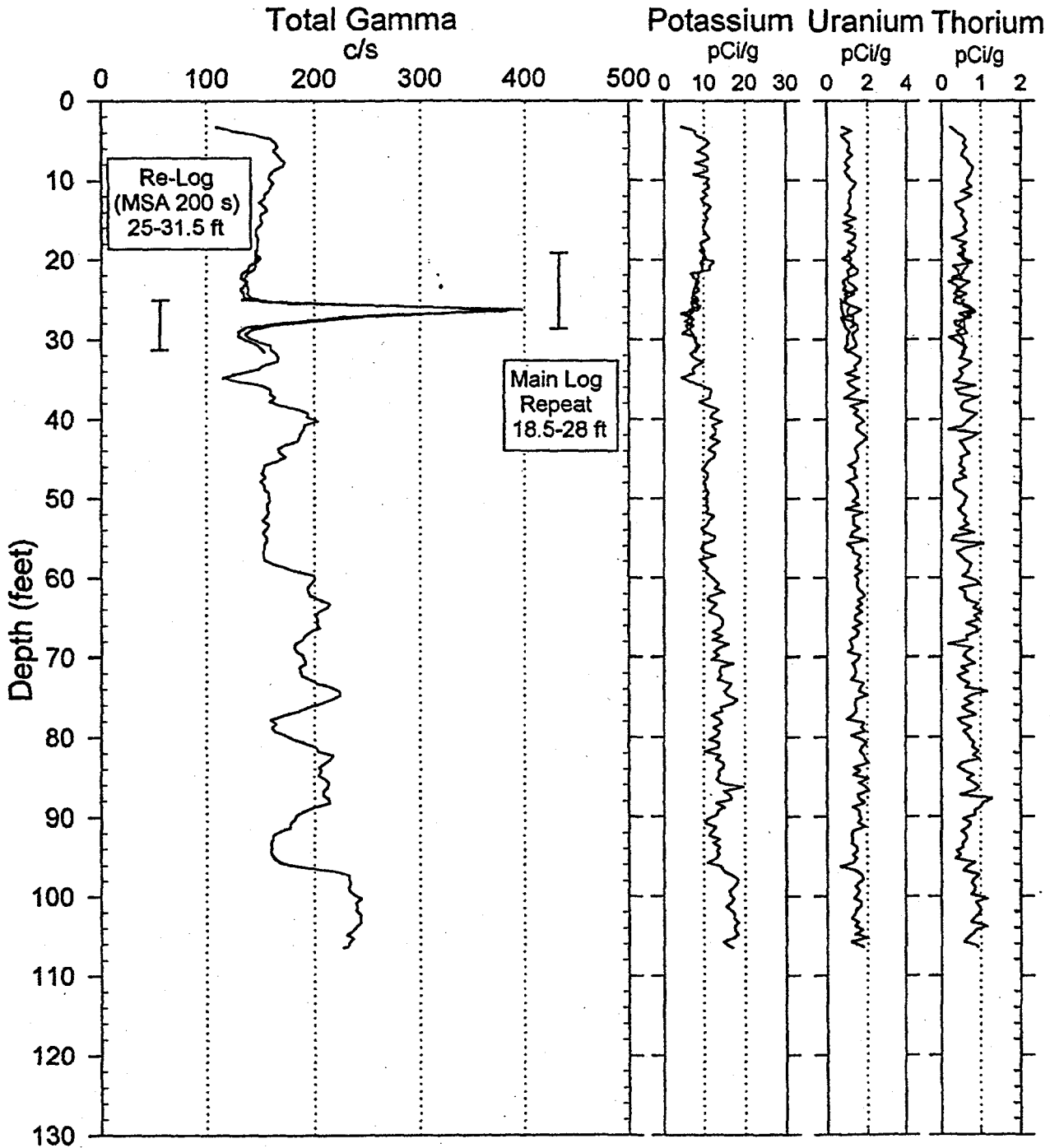
Notes: Pa-233 was the only man-made radionuclide identified. Pa-233 exists from 25 to 30 feet and at 31.5 feet, with a maximum of 27 pCi/g at 26.5 feet.

# RLS Spectral Gamma Ray Borehole Survey

## Waste Management Federal Services NW

Project: Z Crib Geophysics  
Borehole: 299-W18-153

Log Date: Mar. 23 & 27, 1998  
Naturally Occurring Radionuclides



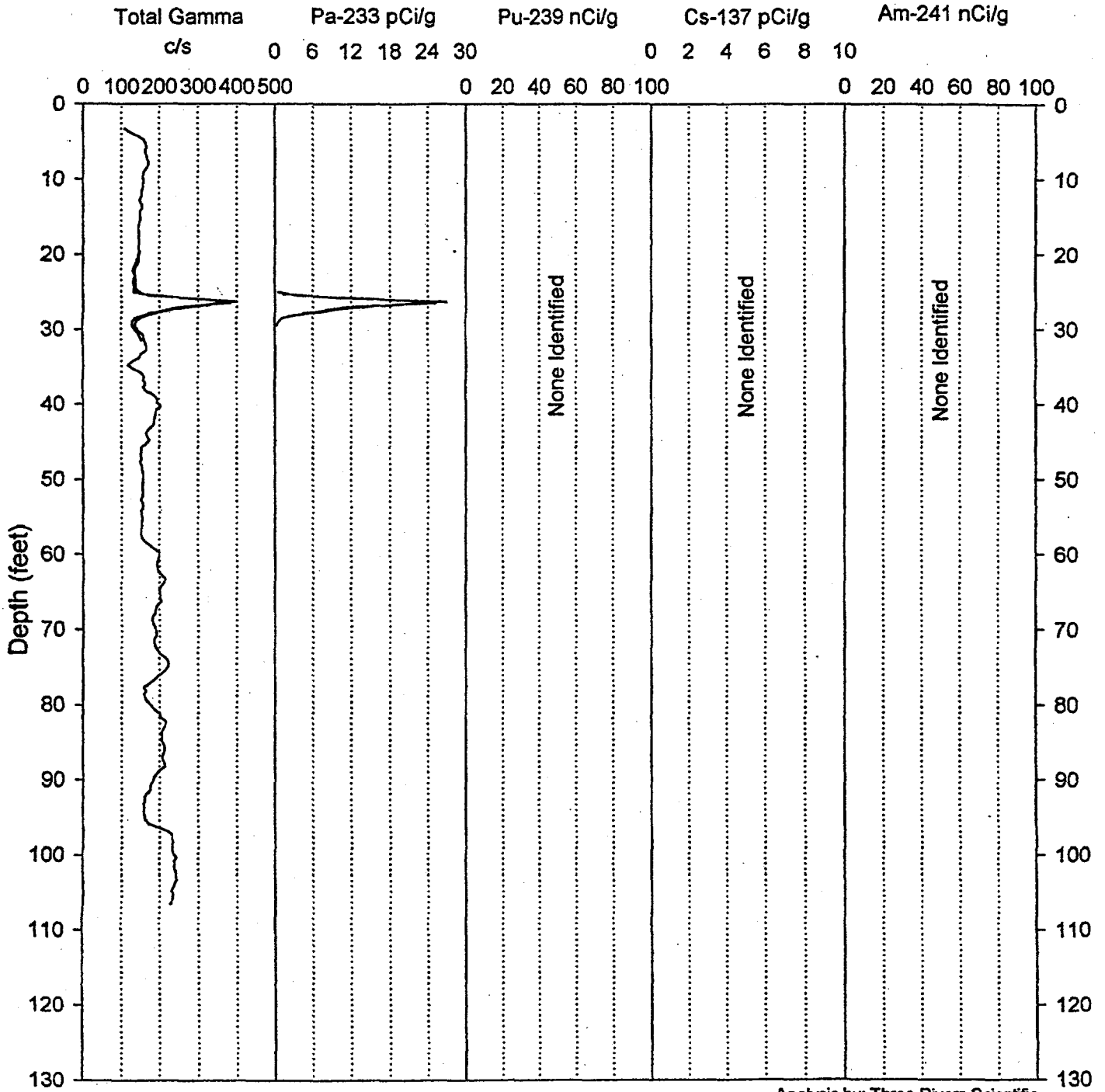
Analysis by: Three Rivers Scientific

# RLS Spectral Gamma Ray Borehole Survey

## Waste Management Federal Services NW

Project: Z Crib Geophysics  
 Borehole: 299-W18-153

Log Date: Mar. 23 & 27, 1998  
 Man-Made Radionuclides of Concern



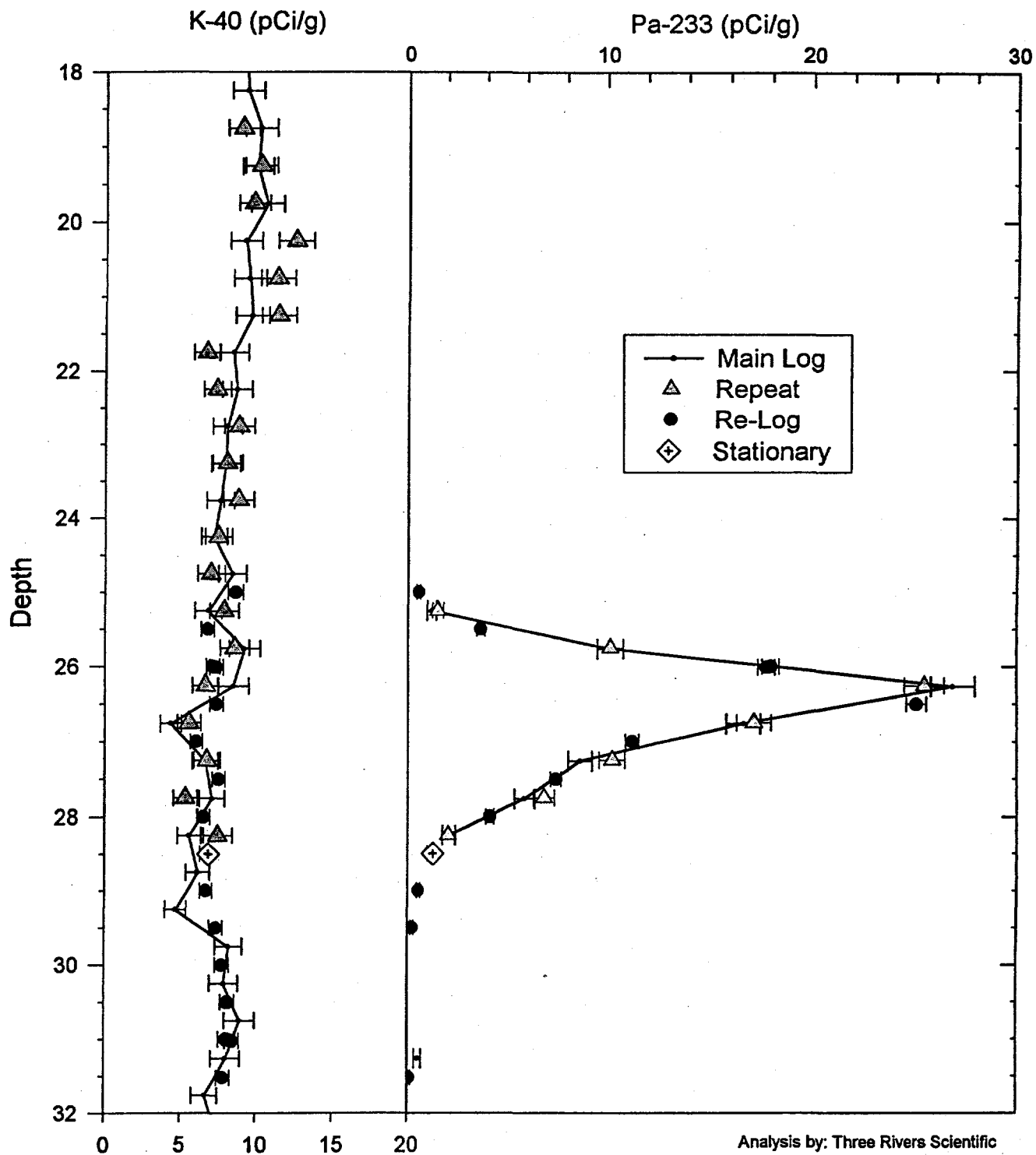
Analysis by: Three Rivers Scientific

# RLS Spectral Gamma Ray Borehole Survey

## Acceptance QA Processing

Project: Z Crib Geophysics  
Borehole: 299-W18-153

Log Date: Mar. 23 & 27, 1998  
Compare Main Log, Repeat, Re-Log



Analysis by: Three Rivers Scientific

**RLS Spectral Gamma Ray Borehole Survey**  
Waste Management Federal Services NW

**Log Analysis Summary Report**

Project: Z Crib Geophysics  
Log Type: HPGe Spectral Gamma Ray

Well ID: 299-W18-153  
Log Dates: Mar. 23&27, 199

**General Notes:**

Total gamma is a response to formation lithology except for the radioactive zone from 25 to 30 feet.

**System Performance Verification:** The pre- and post-log verification was performed using coleman #2. The maximum FWHM for the 583 keV gamma ray photo peak for both survey dates was 2.54 keV. The maximum acceptable FWHM resolution is 3.10 keV for probe RLSG3.1 on the log dates.

**Repeat Interval:** The repeat interval, 25 to 31.5 feet, agrees with the main log within acceptable limits (refer to the Acceptance QA Processing plot).

**Environmental Corrections:** The KUT and man-made radionuclide concentrations have been corrected for casing attenuation over the entire well. No casing correction was applied to the total gamma due to Compton downscatter interference.

**Radionuclides:**

Pa-233 exists from 25 to 30 feet and at 31.5 feet, with a maximum of 27 pCi/g at 26.5 feet.

	<b>Pa-233</b>
<b>max. Concentration</b>	27 pCi/g @ 26.5 ft
<b>max. Depth at MDL</b>	31.5 ft
<b>MDL</b>	0.5 pCi/g

# RLS Spectral Gamma Ray Borehole Survey

## Waste Management Federal Services NW

### Log Header

Project: Z Crib Geophysics

Well: 299-W18-156

Log Type: HPGe Spectral Gamma Ray

#### Borehole Information

Well ID	A7639	Water Depth	None	Total Depth	24 ft
Elevation Reference	No Data	Elevation	No Data ft		
Depth Reference	Top of Casing	Casing Stickup	No Data ft		
Casing Diameter	10 in ID	Depth Interval	0 to 24 ft	Thickness	0.375 in
Casing Diameter	in	Depth Interval	ft	Thickness	in

#### Logging Information

Log Type	HPGe Spectral Gamma Ray	
Company	Waste Management Federal Services NW	
Date/Archive File Name	Apr. 7, 1998	H2W18156
Logging Engineers	R. Wilson	
Instrument Series	RLSG3.1	
Logging Unit	RLS2	
Depth Interval	0 to 23.5 ft	Prefix B198
Instrument Calibration Date	Sep. 9, 1997	
Calibration Report	WHC-SD-EN-TI-292, Rev. 0	

#### Analysis Information

Company	Three Rivers Scientific	
Analyst	Russ Randall	
Date	April 8, 1998	

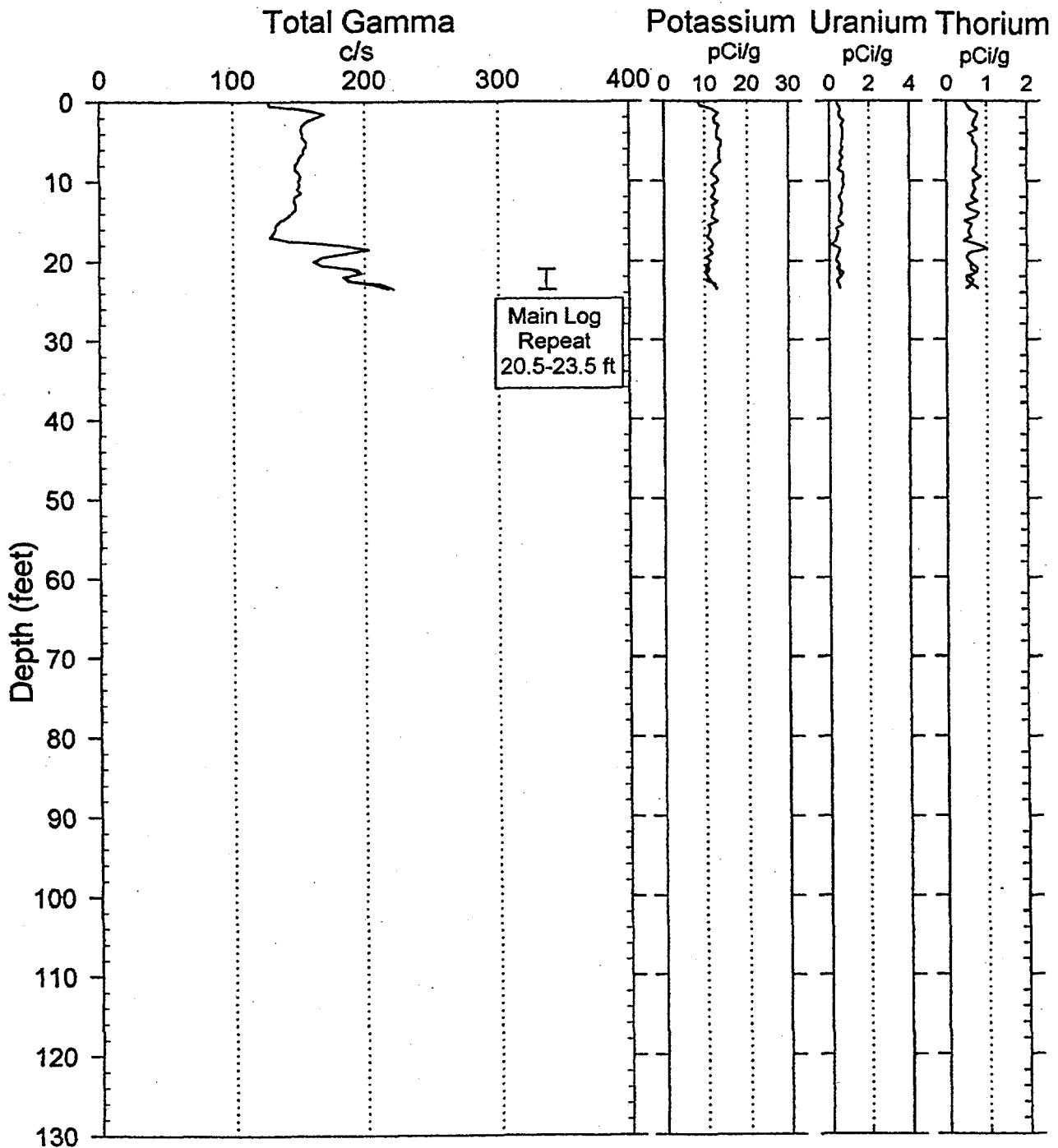
Notes Pa-233 and Pu-239 were identified near the bottom of the well. Pa-233 exists from 17.5 to 23.5 feet, with a maximum reading of 10 pCi/g at 23.5 feet. Pu-239 exists from 22.0 to 23.5 feet, with a maximum of 17 nCi/g at 22 feet, (17 nCi/g on main log pass and 12 nCi/g on repeat pass). Cs-137 exists at three separate depths at MDL, and thus not plotted. No other man made radionuclides detected.

# RLS Spectral Gamma Ray Borehole Survey

## Waste Management Federal Services NW

Project: Z Crib Geophysics  
Borehole: 299-W18-156

Log Date: Apr. 7, 1998  
Naturally Occurring Radionuclides



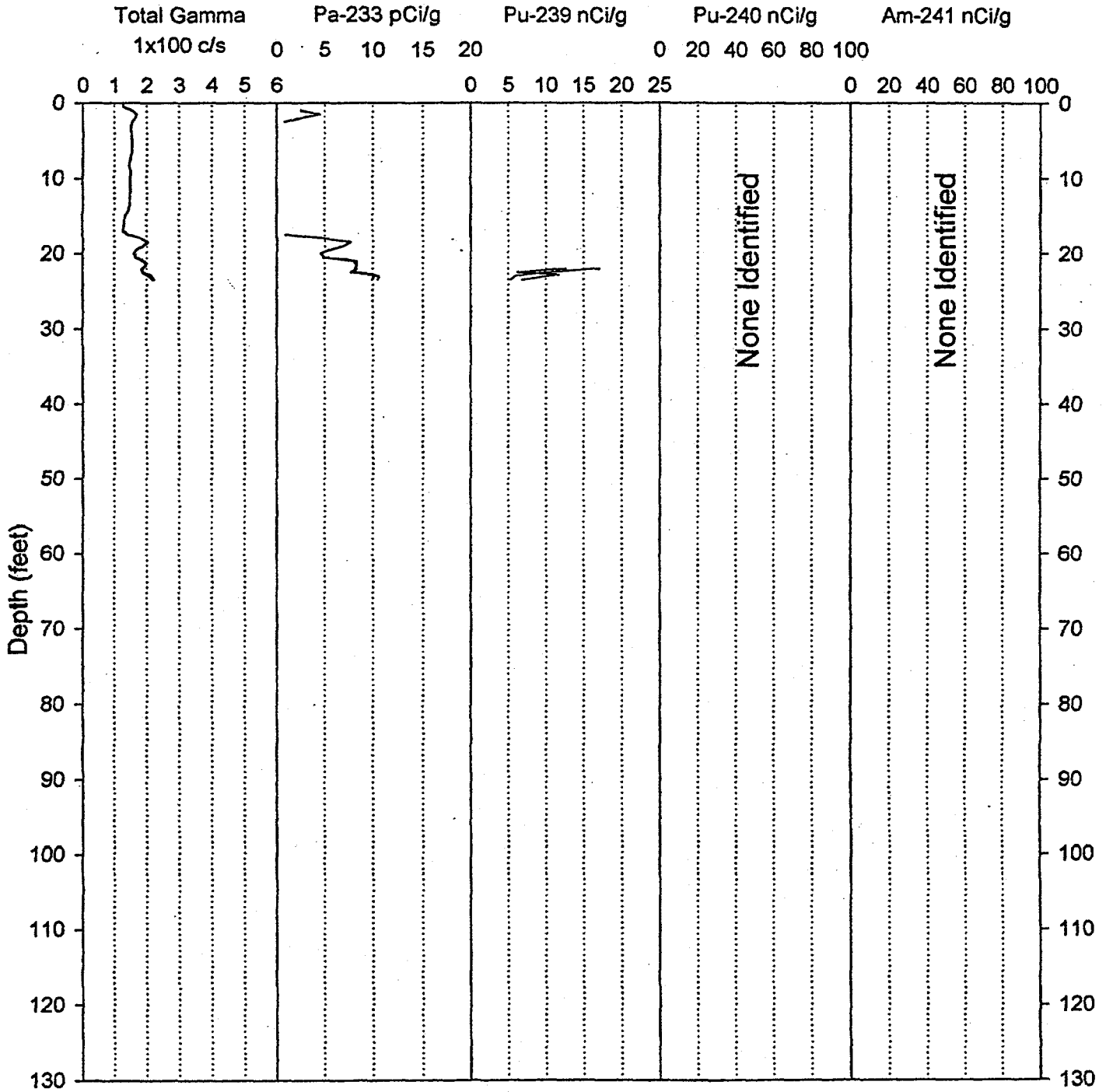
Analysis by: Three Rivers Scientific

# RLS Spectral Gamma Ray Borehole Survey

## Waste Management Federal Services NW

Project: Z Crib Geophysics  
 Borehole: 299-W18-156

Log Date: Apr. 7, 1998  
 Man-Made Radionuclides of Concern

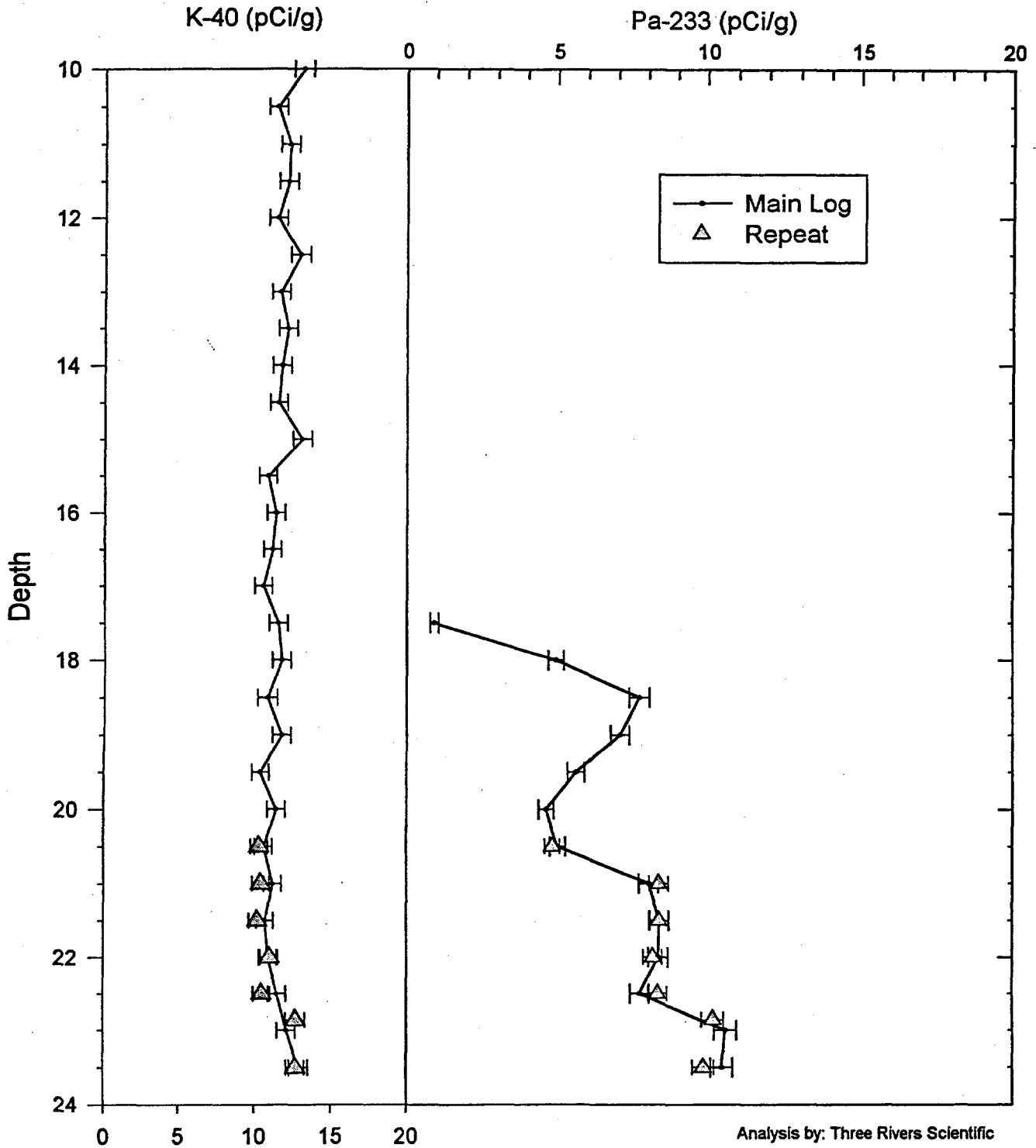


# RLS Spectral Gamma Ray Borehole Survey

## Acceptance QA Processing

Project: Z Crib Geophysics  
Borehole: 299-W18-156

Log Date: Apr. 7, 1998  
Compare Main Log and Repeat



Analysis by: Three Rivers Scientific

**RLS Spectral Gamma Ray Borehole Survey**  
Waste Management Federal Services NW

**Log Analysis Summary Report**

Project: Z Crib Geophysics  
Log Type: HPGe Spectral Gamma Ray

Well ID: 299-W18-156  
Log Dates: Apr. 7, 1998

**General Notes:**

Total gamma is, in general, a response of formation lithology, except from 17 feet to bottom of well at 23.5 feet where man-made radionuclides were encountered.

**System Performance Verification:** The pre- and post-log verification was performed using coleman #2 mantle. The maximum FWHM for the 583 keV gamma ray photo peak for the survey was 2.52 keV. The maximum acceptable FWHM resolution is 3.10 keV for probe RLSG3.1 on the log date.

**Repeat Interval:** The repeat interval, 20.5 to 23.5 feet, agrees with the main log within acceptable limits (refer to the Acceptance QA Processing plot).

**Environmental Corrections:** The KUT and man-made radionuclide concentrations have been corrected for casing attenuation over the entire well. No casing correction was applied to the total gamma due to Compton downscatter interference.

**Radionuclides:**

Pa-233 was identified in the well log data from 17.5 to 23.5 feet and reached a maximum of 10 pCi/g at 23.5 feet. The maximum depth observed for Pa-233 is at the bottom of the borehole, and is 10 times MDL.

Pu-239 was identified from 22.0 to 23.5 feet and reached a maximum of 10 nCi/g at 22.5 feet. The reading at the deepest depth, 23.5 feet is at MDL (5 nCi/g for this data set and casing configuration). Given the low levels of Pu-239 and the high statistical uncertainty, true deepest depth at MDL is un-reliable.

Cs-137 was observed at three separate and single depth points at MDL, and thus not plotted.

	<b>Pa-233</b>	<b>Pu-239</b>
<b>max. Concentration</b>	10 pCi/g @ 23.5 ft	10 nCi/g @ 22.5 ft
<b>max. Depth at MDL</b>	below well depth	23.5 ft
<b>MDL</b>	1 pCi/g	5 nCi/g

# RLS Spectral Gamma Ray Borehole Survey

## Waste Management Federal Services NW

### Log Header

Project: Z Crib Geophysics

Well: 299-W18-158

Log Type: HPGe Spectral Gamma Ray

#### Borehole Information

Well ID	<u>A7641</u>	Water Depth	<u>None</u>	Total Depth	<u>127</u> ft
Elevation Reference	<u>Ground Level</u>	Elevation	<u>670</u> ft		
Depth Reference	<u>Top of Casing</u>	Casing Stickup	<u>2.12</u> ft		
Casing Diameter	<u>8</u> in ID	Depth Interval	<u>0 to 94</u> ft	Thickness	<u>0.312</u> in
Casing Diameter	<u>6</u> in ID	Depth Interval	<u>0 to 127</u> ft	Thickness	<u>0.312</u> in
Casing Diameter	<u>   </u> in	Depth Interval	<u>      </u> ft	Thickness	<u>      </u> in

#### Logging Information

Log Type	HPGe Spectral Gamma Ray	
Company	Waste Management Federal Services NW	
Date/Archive File Name	Mar. 13&18, 1998	H2W18158
Logging Engineers	R. Wilson	
Instrument Series	RLSG3.1	
Logging Unit	RLS2	
Depth Interval	0 to 127 ft	Prefix B171
	59 to 63.5 ft	Prefix B175
Instrument Calibration Date	Sep. 9, 1997	
Calibration Report	WHC-SD-EN-TI-292, Rev. 0	

#### Analysis Information

Company	Three Rivers Scientific
Analyst	Russ Randall
Date	March 21, 1998

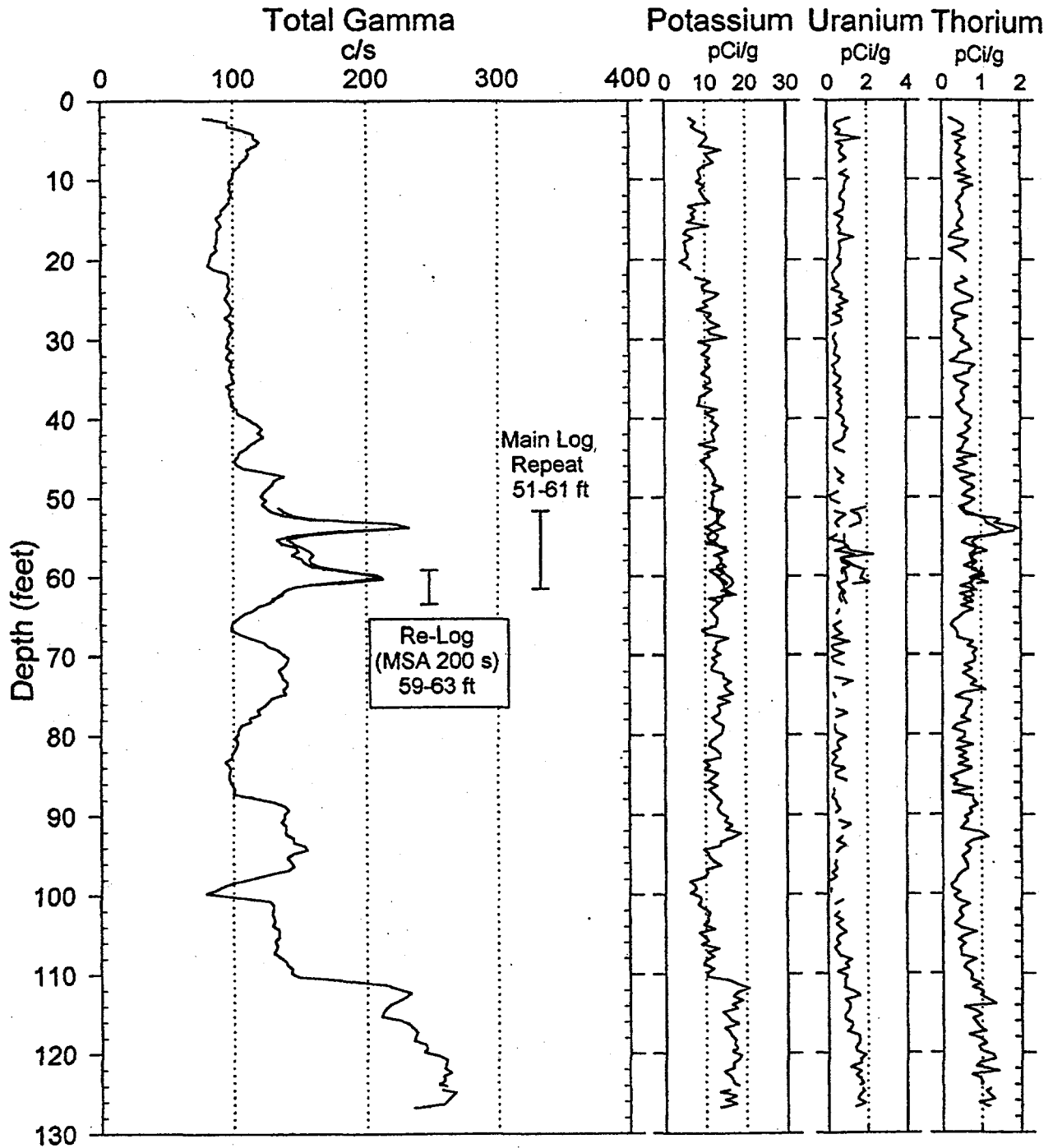
Notes Pa-233 was identified in two short intervals at 47 and 60 feet. The maximum concentration for Pa-233 was 11 pCi/g at 60 feet. The gross gamma peak at 55 feet is due to increased thorium response. However, there is a lack of secular equilibrium indicating possible waste by-product. No other man-made radionuclides were detected.

# RLS Spectral Gamma Ray Borehole Survey

## Waste Management Federal Services NW

Project: Z Crib Geophysics  
Borehole: 299-W18-158

Log Date: Mar. 13 & 18, 1998  
Naturally Occurring Radionuclides



Analysis by: Three Rivers Scientific

# RLS Spectral Gamma Ray Borehole Survey

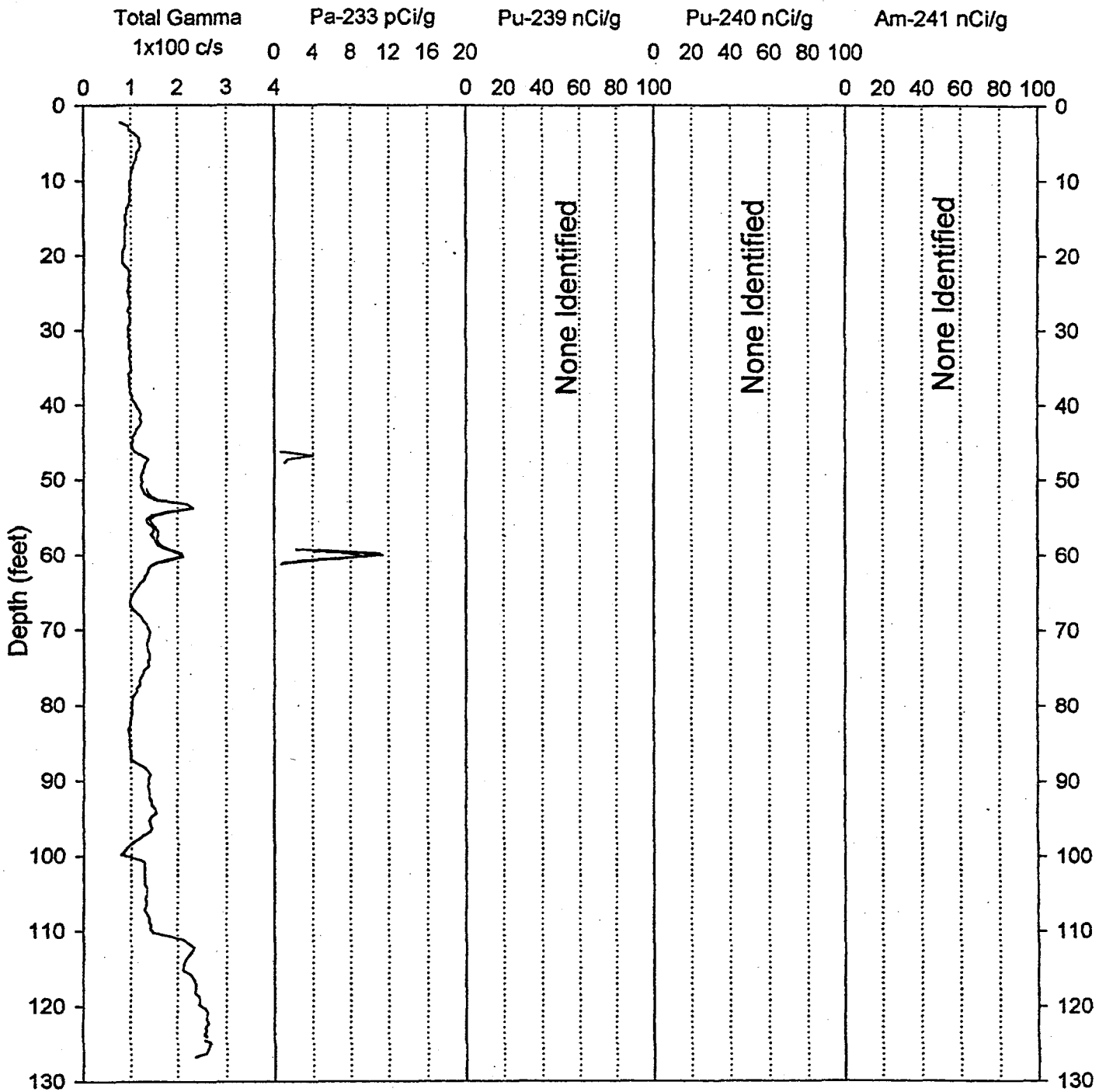
Waste Management Federal Services NW

Project: Z Crib Geophysics

Log Date: Mar. 13 & 18, 1998

Borehole: 299-W18-158

Man-Made Radionuclides of Concern

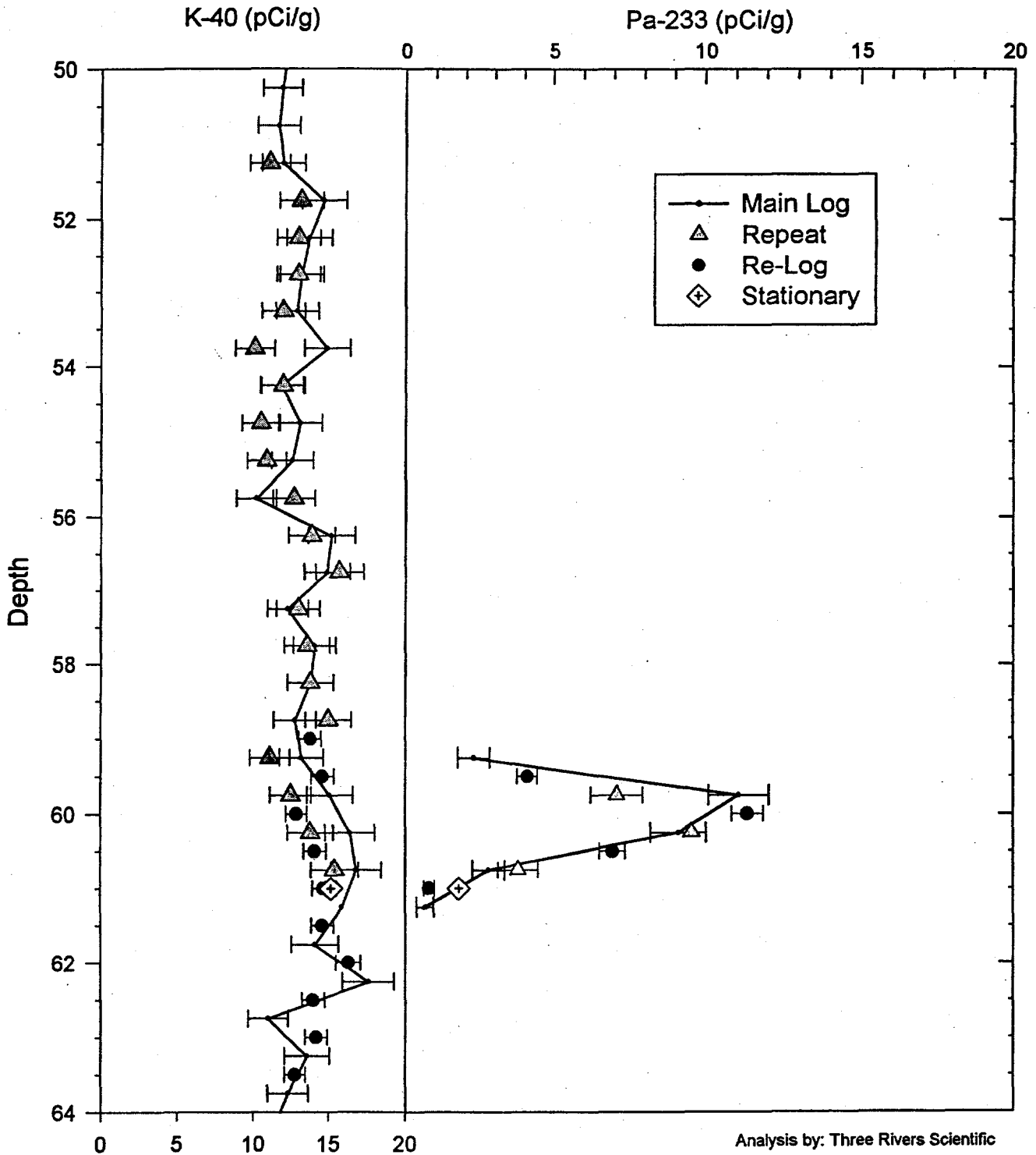


# RLS Spectral Gamma Ray Borehole Survey

## Acceptance QA Processing

Project: Z Crib Geophysics  
 Borehole: 299-W18-158

Log Date: Mar. 13 & 18, 1998  
 Compare Main Log, Repeat, Re-Log



Analysis by: Three Rivers Scientific

# RLS Spectral Gamma Ray Borehole Survey

Waste Management Federal Services NW

## Log Analysis Summary Report

Project: Z Crib Geophysics  
Log Type: HPGe Spectral Gamma-Ray

Well ID: 299-W18-158  
Log Dates: Mar. 13&18, 1998

### General Notes:

Total gamma is, in general, a response of formation lithology, except 47 and 60 ft where man made radionuclides were encountered.

**System Performance Verification:** The pre- and post-log verification was performed using coleman #2. The maximum FWHM for the 583 keV gamma ray photo peak for both survey dates was 2.42 keV. The maximum acceptable FWHM resolution is 3.10 keV for probe RLSG3.1 on the log dates.

**Repeat Interval:** The repeat interval, 50 to 64 feet, agrees with the main log within acceptable limits (refer to the Acceptance QA Processing plot).

**Environmental Corrections:** The KUT and man made radionuclide concentrations have been corrected for casing attenuation over the entire well. No casing correction was applied to the total gamma due to Compton downscatter interference. The gross gamma increase at 55 feet is from Tl-208, normally a daughter product of naturally occurring thorium; however, the increase cannot be determined to be solely due to natural lithology and may be a waste by-product.

**Radon Pumping:** Low barometric pressure permits free radon-222 in the formation to vent up the borehole, creating additional uranium gamma-ray daughters inside the casing that add to the logging signal. The high apparent uranium concentrations during low barometric pressure vents will not agree with formation gamma-ray activity when radon is not venting up boreholes. The re-log of 3/18/1998 compared to the main log of 3/13/1998 demonstrates a small, but noticeable difference in the uranium and subsequently a moderately poor gross gamma log repeat.

### Radionuclides:

Pa-233 exists from 46.2 to 47.7 feet and from 59.2 to 61.2 feet, with a maximum of 11 pCi/g at 60 feet.

	Pa-233
max. Concentration	11 pCi/g @ 60 ft
max. Depth at MDL	61 ft
MDL	1 pCi/g

# RLS Spectral Gamma Ray Borehole Survey

## Waste Management Federal Services NW

### Log Header

Project: Z Crib Geophysics

Well: 299-W18-159

Log Type: HPGe Spectral Gamma Ray

#### Borehole Information

Well ID	<u>A7642</u>	Water Depth	<u>None</u>	Total Depth	<u>120</u>	ft
Elevation Reference	<u>Ground Level</u>	Elevation	<u>670</u>			ft
Depth Reference	<u>Top of Casing</u>	Casing Stickup	<u>1.21</u>			ft
Casing Diameter	<u>6</u> in ID	Depth Interval	<u>0 to 120</u>	Thickness	<u>0.21</u>	in
Casing Diameter	<u>   </u> in	Depth Interval	<u>   </u> ft	Thickness	<u>   </u>	in

#### Logging Information

Log Type	HPGe Spectral Gamma Ray	
Company	Waste Management Federal Services NW	
Date/Archive File Name	Mar. 16&25, 1998	H2W18159
Logging Engineers	R. Wilson	
Instrument Series	RLSG3.1	
Logging Unit	RLS2	
Depth Interval	0 to 120 ft	Prefix B172
	56.5 to 64 ft	Prefix B182
Instrument Calibration Date	Sep. 9, 1997	
Calibration Report	WHC-SD-EN-TI-292, Rev. 0	

#### Analysis Information

Company	Three Rivers Scientific
Analyst	Russ Randall
Date	March 27, 1998

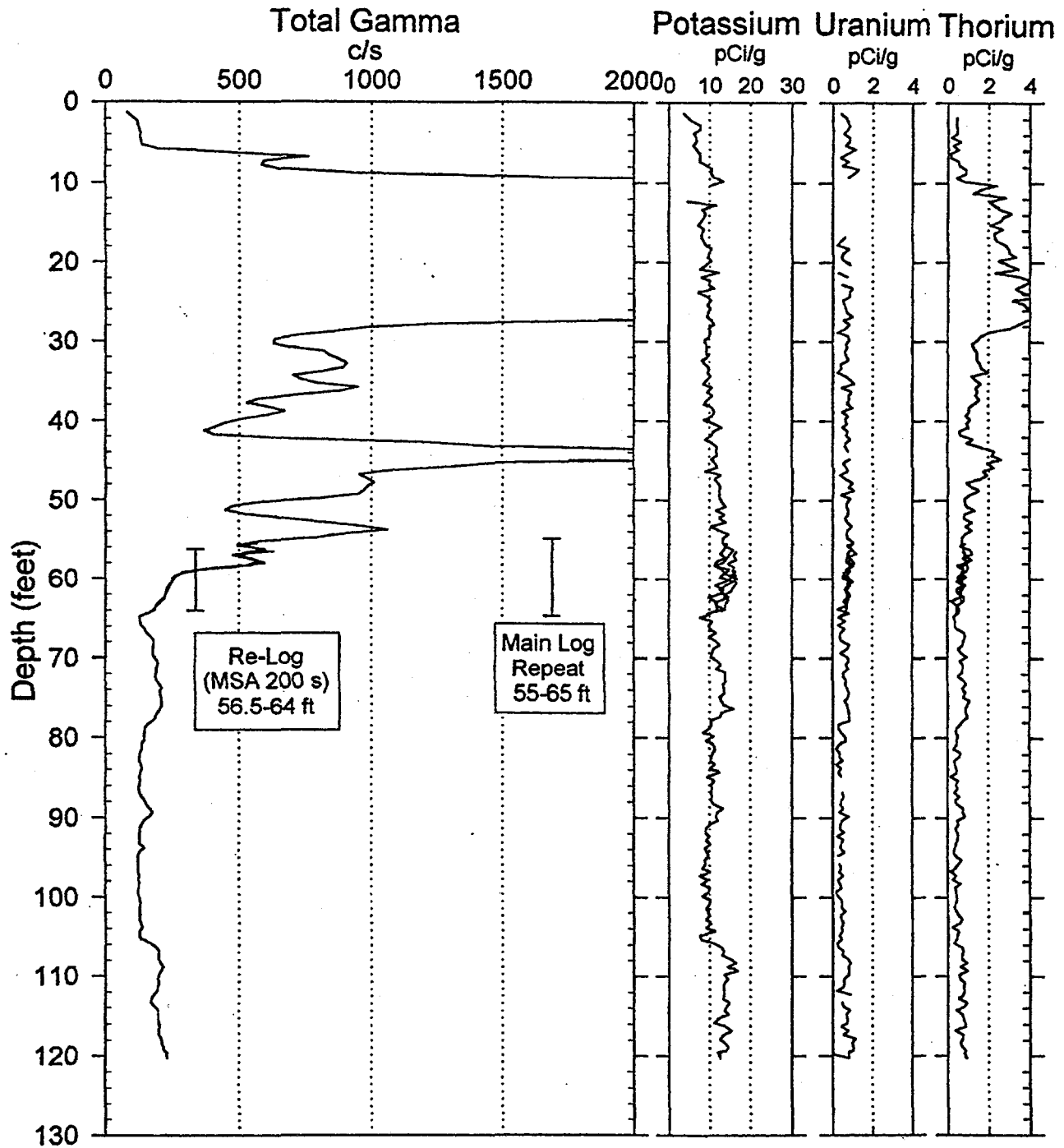
Notes Pa-233 exists from 12 to 54 feet, with a maximum of 63 pCi/g at 64 feet. Pu-239 exists from 6 to 64 feet, with a maximum of 25,000 nCi/g at 11 feet. Am-241 exists from 10 to 64 feet, with a maximum of 2,500 nCi/g at 14 feet. Cs-137 exists from 10 to 59 feet, with a maximum of 23 pCi/g at 11 feet. The Am-241 is relative and not absolute due to interference from other photo peaks. Pu-240 is also likely, but the interference rules out any possibility of quantification. No other man-made radionuclides were detected, however, many other fission and neutron induced gamma rays are present.

# RLS Spectral Gamma Ray Borehole Survey

## Waste Management Federal Services NW

Project: Z Crib Geophysics  
Borehole: 299-W18-159

Log Date: Mar. 16 & 25, 1998  
Naturally Occurring Radionuclides



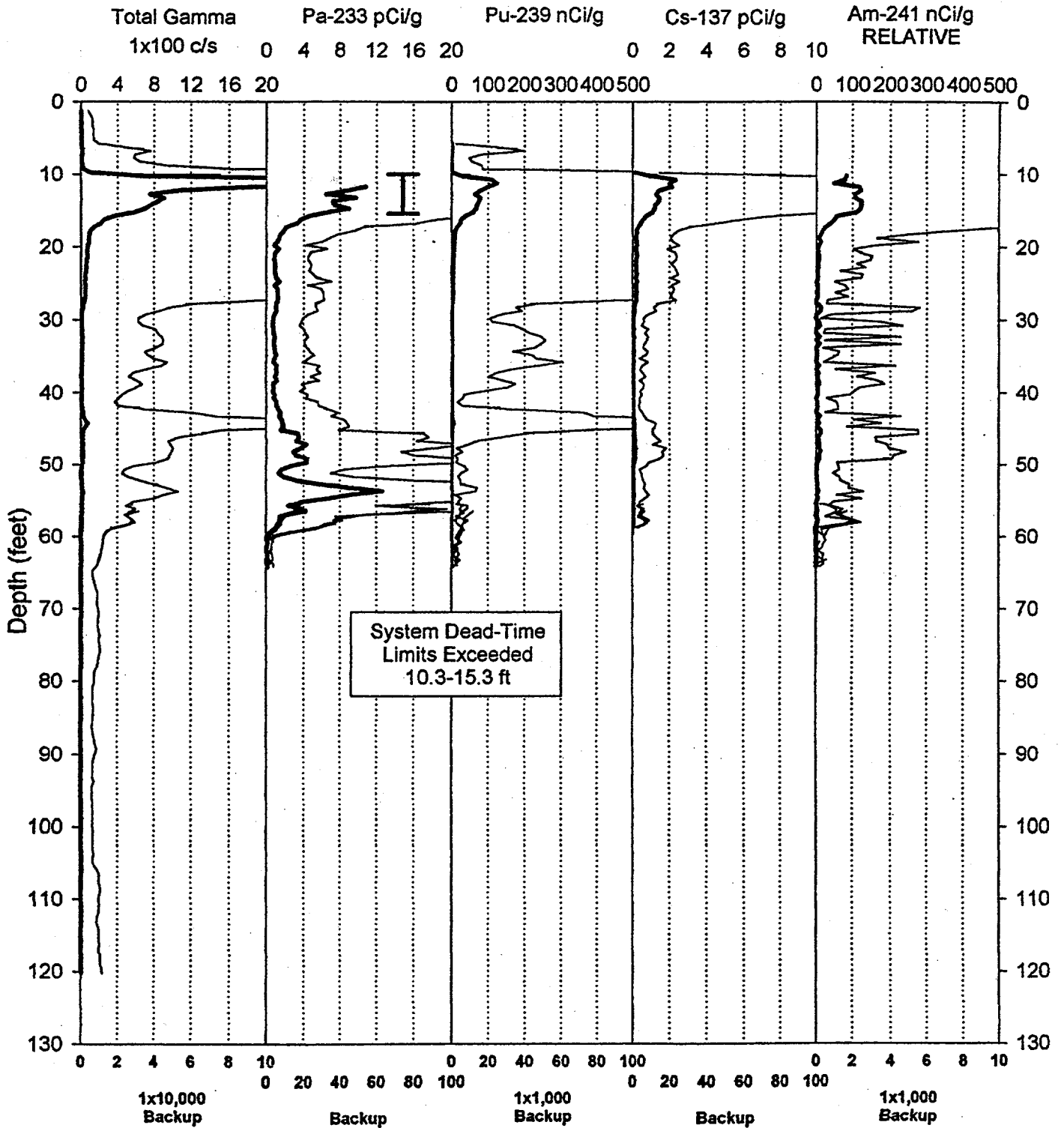
Analysis by: Three Rivers Scientific

# RLS Spectral Gamma Ray Borehole Survey

## Waste Management Federal Services NW

Project: Z Crib Geophysics  
 Borehole: 299-W18-159

Log Date: Mar. 16 & 25, 1998  
 Man-Made Radionuclides of Concern



A.51

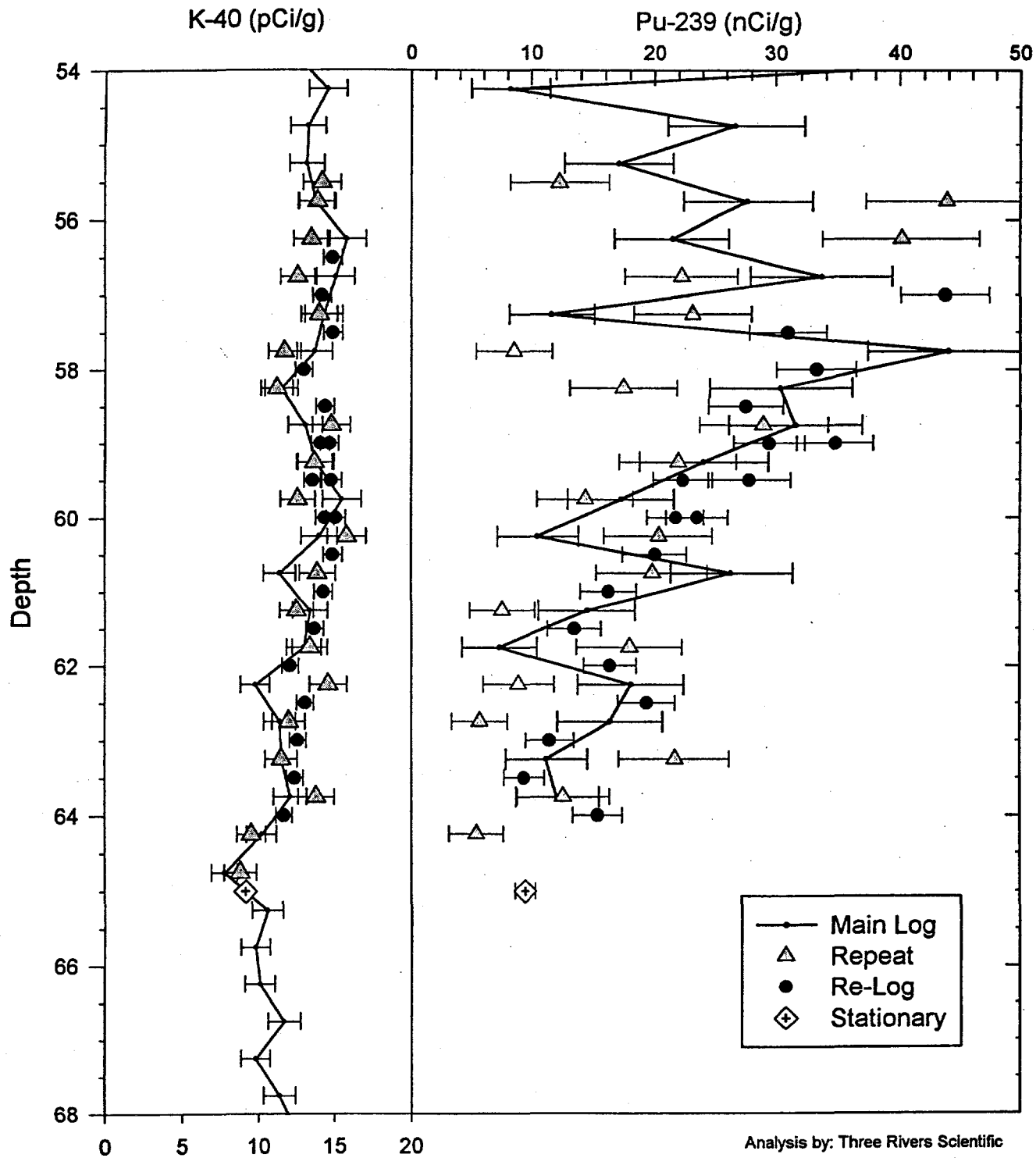
Analysis by: Three Rivers Scientific

# RLS Spectral Gamma Ray Borehole Survey

## Acceptance QA Processing

Project: Z Crib Geophysics  
 Borehole: 299-W18-159

Log Date: Mar. 16 & 25, 1998  
 Compare Main Log, Repeat, Re-Log



Analysis by: Three Rivers Scientific

# RLS Spectral Gamma Ray Borehole Survey

## Waste Management Federal Services NW

### Log Analysis Summary Report

Project: Z Crib Geophysics  
 Log Type: HPGe Spectral Gamma-Ray

Well ID: 299-W18-159  
 Log Dates: Mar. 16&25, 1998

**General Notes:**

Total gamma is a response to man-made gamma ray emitters from surface to 64 feet, and a function of formation lithology below 64 feet.

**System Performance Verification:** The pre- and post-log verification was performed using coleman #2. The maximum FWHM for the 583 keV gamma ray photo peak for both survey dates was 2.38 keV. The maximum acceptable FWHM resolution is 3.10 keV for probe RLSG3.1 on the log dates.

**Repeat Interval:** The repeat interval, 55 to 65 feet, agrees with the main log within acceptable limits (refer to the Acceptance QA Processing plot).

**Environmental Corrections:** The KUT and man-made radionuclide concentrations have been corrected for casing attenuation over the entire well. No casing correction was applied to the total gamma due to Compton downscatter interference. The thorium from 8 to 64 feet is from Tl-208, normally a daughter product of naturally occurring thorium; however, the secular equilibrium is greatly disturbed, indicating that the thorium is not solely due to natural lithology and may be a waste by-product.

**Radionuclides:**

Pa-233 exists from 12 to 64 feet, with a maximum of 63 pCi/g at 54 feet. Pu-239 exists from 6 to 64 feet, with a maximum of 25,000 nCi/g at 11 feet. Am-241 exists from 10 to 64 feet, with a maximum of 2,500 nCi/g at 14 feet. Cs-137 exists from 10 to 59 feet, with a maximum of 23 pCi/g at 11 feet. The Am-241 is relative and not absolute due to interference from other photo peaks. Pu-240 is also likely, but the interference rules out any possibility of quantification. No other man-made radionuclides were detected; however, many other fission and neutron induced gamma rays are present.

The high degree of variance of Am-241 over the interval 28 to 34 feet is real, and not an artifact of the processing, even though the processing is adversely affected by other photo peak interference.

The re-log interval of 56.5 to 64 feet yields Pu-239 at 64 feet with a reading of 15 nCi/g, approximately a factor of two above MDL levels for this well configuration. The same is true for Pa-233 and Am-241, in that they are above MDL at the lowest point of the re-log section.

	Pa-233	Pu-239	Cs-137	Am-241
max. Concentration	63 pCi/g @ 54 ft	25,000 nCi/g @ 11 ft	23 pCi/g @ 11 ft	2500 nCi/g @ 14 ft
max. Depth at MDL	64 ft	64 ft	58.5 ft	64 ft
MDL	0.7 pCi/g	7 nCi/g	0.06 pCi/g	10 nCi/g

**RLS Spectral Gamma Ray Borehole Survey**  
**Waste Management Federal Services NW**

**Log Header**

Project: Z Crib Geophysics

Well: 299-W18-167

Log Type: HPGe Spectral Gamma Ray

**Borehole Information**

Well ID	<u>A7649</u>	Water Depth	<u>None</u>	Total Depth	<u>128</u> ft
Elevation Reference	<u>Ground Level</u>	Elevation	<u>666</u> ft		
Depth Reference	<u>Top of Casing</u>	Casing Stickup	<u>2.54</u> ft		
Casing Diameter	<u>8</u> in ID	Depth Interval	<u>0 to 128</u> ft	Thickness	<u>0.312</u> in
Casing Diameter	<u>   </u> in	Depth Interval	<u>      </u> ft	Thickness	<u>      </u> in

**Logging Information**

Log Type	HPGe Spectral Gamma Ray	
Company	Waste Management Federal Services NW	
Date/Archive File Name	Mar. 10&17, 1998	H2W18167
Logging Engineers	R. Wilson	
Instrument Series	RLSG3.1	
Logging Unit	RLS2	
Depth Interval	0 to 128 ft	Prefix B169
	56 to 63.5 ft	Prefix B173
Instrument Calibration Date	Sep. 9, 1997	
Calibration Report	WHC-SD-EN-TI-292, Rev. 0	

**Analysis Information**

Company	Three Rivers Scientific
Analyst	Russ Randall
Date	March 25, 1998

Notes Pa-233 reached a maximum of 19 pCi/g at a depth of 57.5 feet. Pu-239 reached a maximum of 19 nCi/g at 57.5 feet. Also, Pa- 233 was detected at low levels in a thin zone at 50 feet. Am-241 reached a maximum of 128 nCi/g at 57.5 feet. Pu-240 cannot be computed due to strong interference of the photo peaks. No other man-made radionuclides were detected.

# RLS Spectral Gamma Ray Borehole Survey

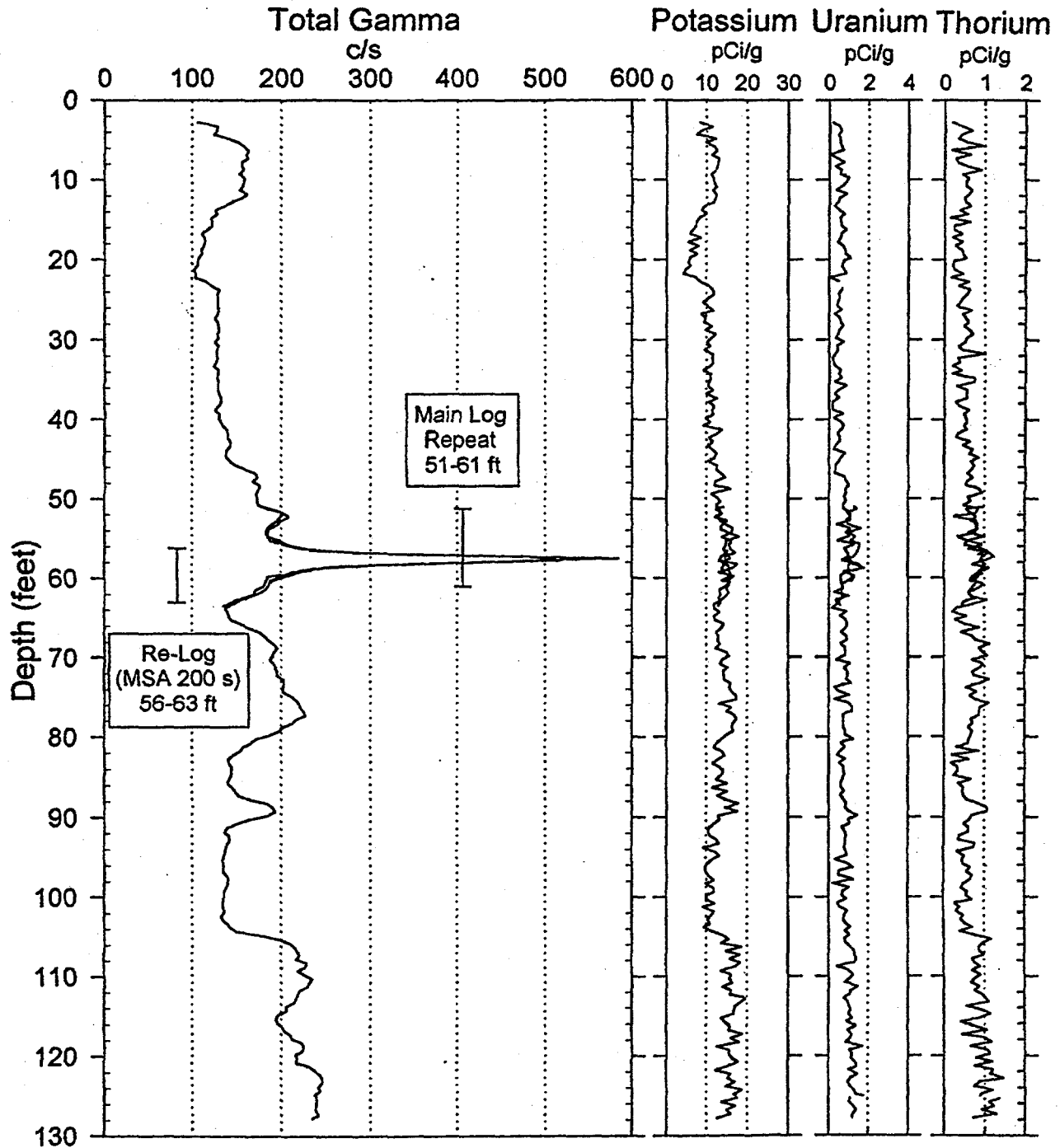
## Waste Management Federal Services NW

Project: Z Crib Geophysics

Log Date: Mar. 10 & 17, 1998

Borehole: 299-W18-167

Naturally Occurring Radionuclides



Analysis by: Three Rivers Scientific

# RLS Spectral Gamma Ray Borehole Survey

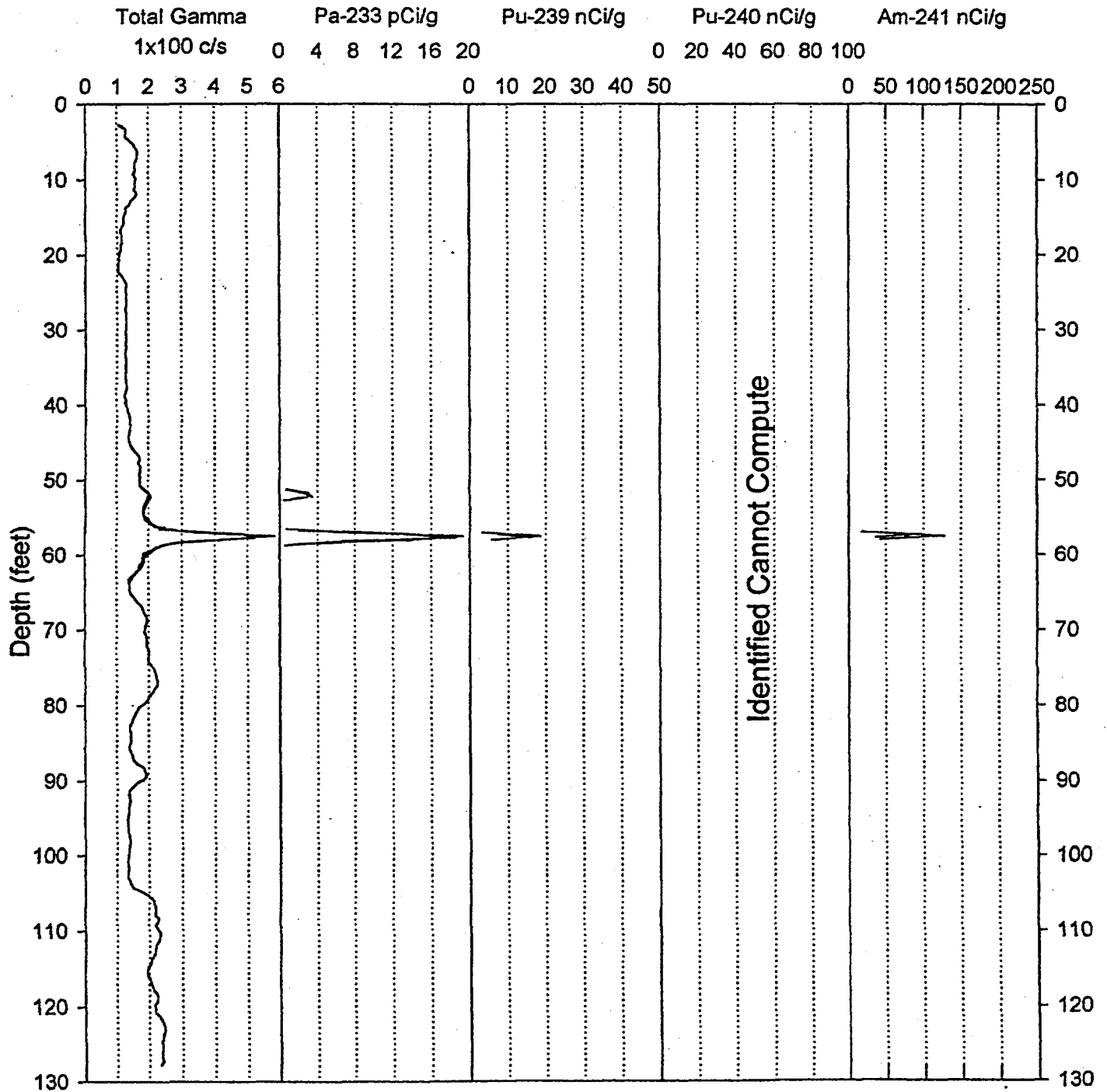
Waste Management Federal Services NW

Project: Z Crib Geophysics

Log Date: Mar. 10 & 17, 1998

Borehole: 299-W18-167

Man-Made Radionuclides of Concern

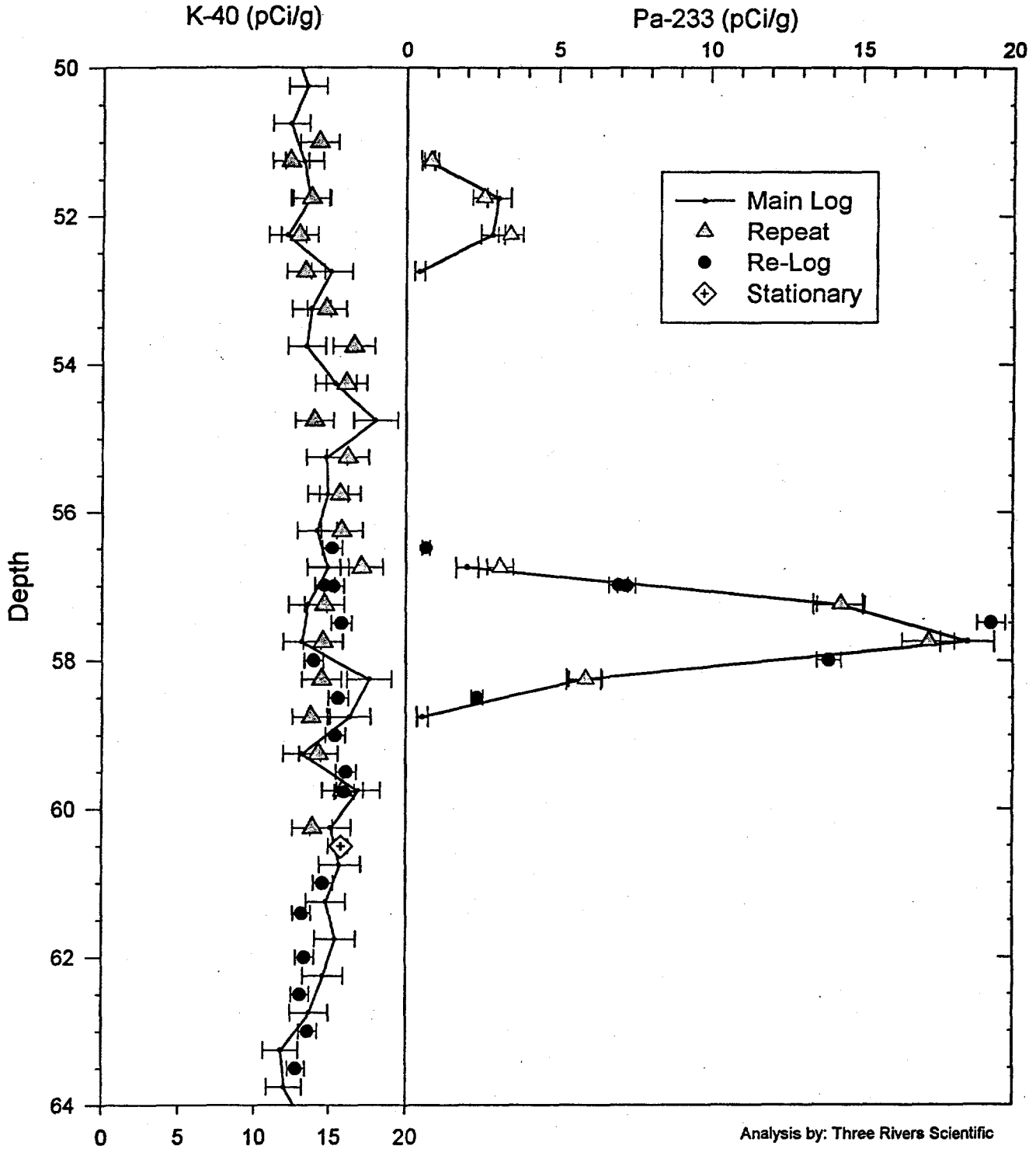


# RLS Spectral Gamma Ray Borehole Survey

## Acceptance QA Processing

Project: Z Crib Geophysics  
Borehole: 299-W18-167

Log Date: Mar. 10 & 17, 1998  
Compare Main Log, Repeat, Re-Log



Analysis by: Three Rivers Scientific

**RLS Spectral Gamma Ray Borehole Survey**  
Waste Management Federal Services NW

**Log Analysis Summary Report**

Project: Z Crib Geophysics  
Log Type: HPGe Spectral Gamma Ray

Well ID: 299-W18-167  
Log Dates: Mar. 10&17, 1998

**General Notes:**

Total gamma is, in general, a response of formation lithology, except at the thin zone at 58 feet, where man-made radionuclides were encountered.

**System Performance Verification:** The pre- and post-log verification was performed using coleman #2 mantle. The maximum FWHM for the 583 keV gamma ray photo peak for both survey dates was 2.33 keV. The maximum acceptable FWHM resolution is 3.10 keV for probe RLSG3.1 on the log dates.

**Repeat Interval:** The repeat interval, 51 to 61 feet, agrees with the main log within acceptable limits (refer to the Acceptance QA Processing plot).

**Environmental Corrections:** The KUT and man-made radionuclide concentrations have been corrected for casing attenuation over the entire well. No casing correction was applied to the total gamma due to Compton downscatter interference.

**Radionuclides:**

Pa-233 exists in two thin zones at 51.7 and 57.7 feet, with a maximum of 19 pCi/g at 57.7 feet. Pu-239 exists at 57.7 feet, with a maximum of 19 nCi/g at 57.7 feet. Pu-240 cannot be computed due to strong interference of the photo peaks. Am-241 exists at 57.7 feet, with a maximum of 128 nCi/g.

The maximum depth for Pa-233 is 58.5 feet at a concentration above MDL, but the next lower depth sample is absent Pa-233. The MDL for this depth in the re-log is 0.5 pCi/g. The 800 second stationary reading at 60.5 feet was below MDL even for the 800 second reading.

	<b>Pa-233</b>	<b>Pu-239</b>	<b>Am-241</b>
<b>max. Concentration</b>	19 pCi/g @ 57.5 ft	19 nCi/g @ 57.5 ft	128 nCi/g @ 57.5 ft
<b>max. Depth at MDL</b>	58.5 ft	58 ft	58 ft
<b>MDL</b>	0.5 pCi/g	5 nCi/g	25 nCi/g

# RLS Spectral Gamma Ray Borehole Survey

## Waste Management Federal Services NW

### Log Header

Project: Z Crib Geophysics

Well: 299-W18-168

Log Type: HPGe Spectral Gamma Ray

#### Borehole Information

Well ID	<u>A7650</u>	Water Depth	<u>None</u>	Total Depth	<u>127</u> ft
Elevation Reference	<u>Ground Level</u>	Elevation	<u>665.7</u> ft		
Depth Reference	<u>Top of Casing</u>	Casing Stickup	<u>2.16</u> ft		
Casing Diameter	<u>8</u> in ID	Depth Interval	<u>0 to 127</u> ft	Thickness	<u>0.312</u> in
Casing Diameter	<u>   </u> in	Depth Interval	<u>      </u> ft	Thickness	<u>      </u> in

#### Logging Information

Log Type	HPGe Spectral Gamma Ray	
Company	Waste Management Federal Services NW	
Date/Archive File Name	Mar. 11&18, 1998	H2W18168
Logging Engineers	R. Wilson	
Instrument Series	RLSG3.1	
Logging Unit	RLS2	
Depth Interval	0 to 126.7 ft	Prefix B170
	60 to 66.5 ft	Prefix B176
Instrument Calibration Date	Sep. 9, 1997	
Calibration Report	WHC-SD-EN-TI-292, Rev. 0	

#### Analysis Information

Company	Three Rivers Scientific
Analyst	Randall Price
Date	March 24, 1998

Notes Pa-233 exists from 49.5 to 66 feet, with a maximum of 15 pCi/g at 51 feet. Pu-239 exists from 50 to 62 feet at concentrations at or below MDL, based upon a summing technique for the higher sampled re-log data. Am-241 exists from 50 to 64 feet, with a maximum of 70 nCi/g at 51 feet. Cs-137 exists from 49.5 to 64 feet at concentrations less than 1 pCi/g.

# RLS Spectral Gamma Ray Borehole Survey

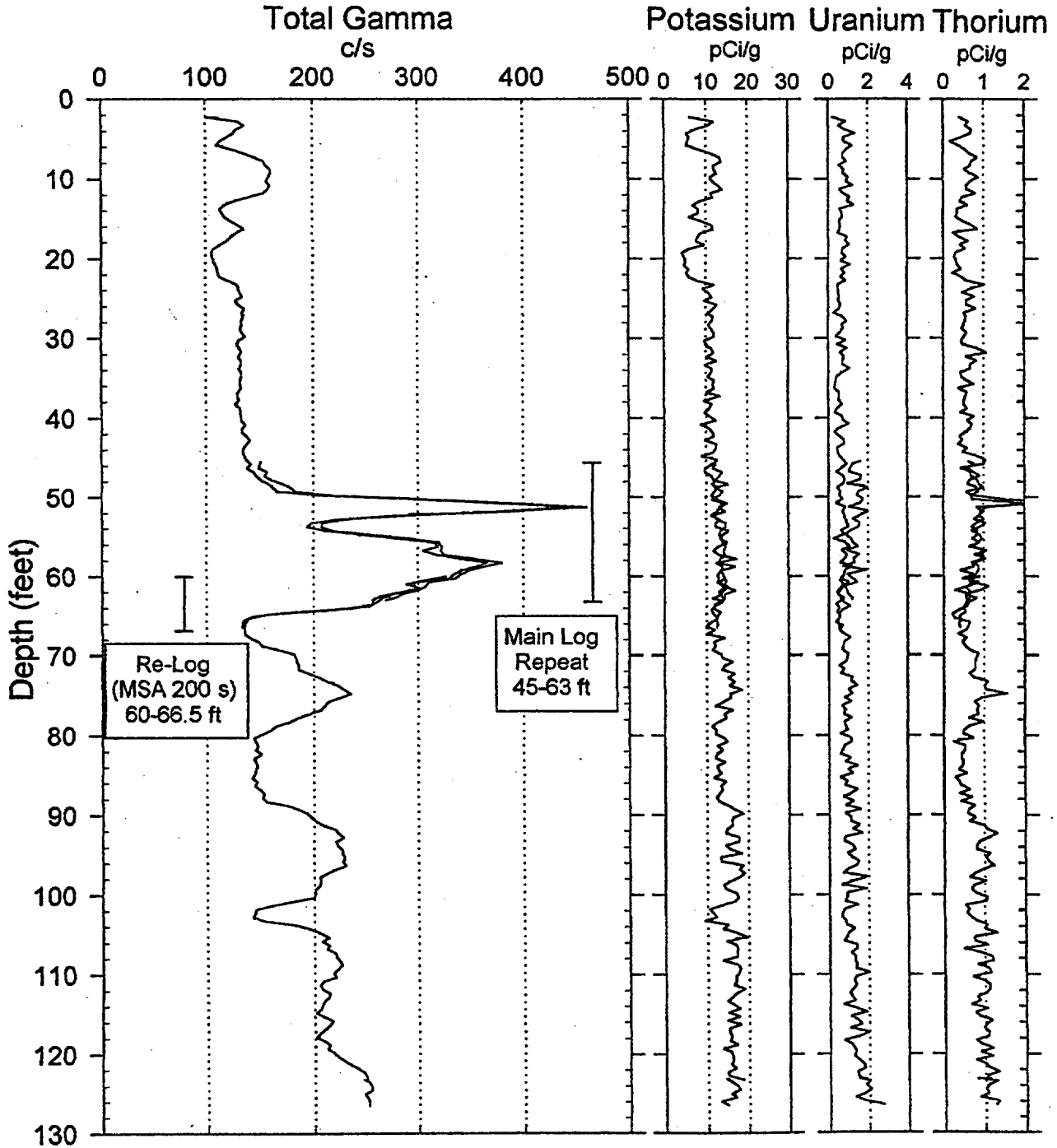
## Waste Management Federal Services NW

Project: Z Crib Geophysics

Log Date: Mar. 11&18, 1998

Borehole: 299-W18-168

Naturally Occurring Radionuclides



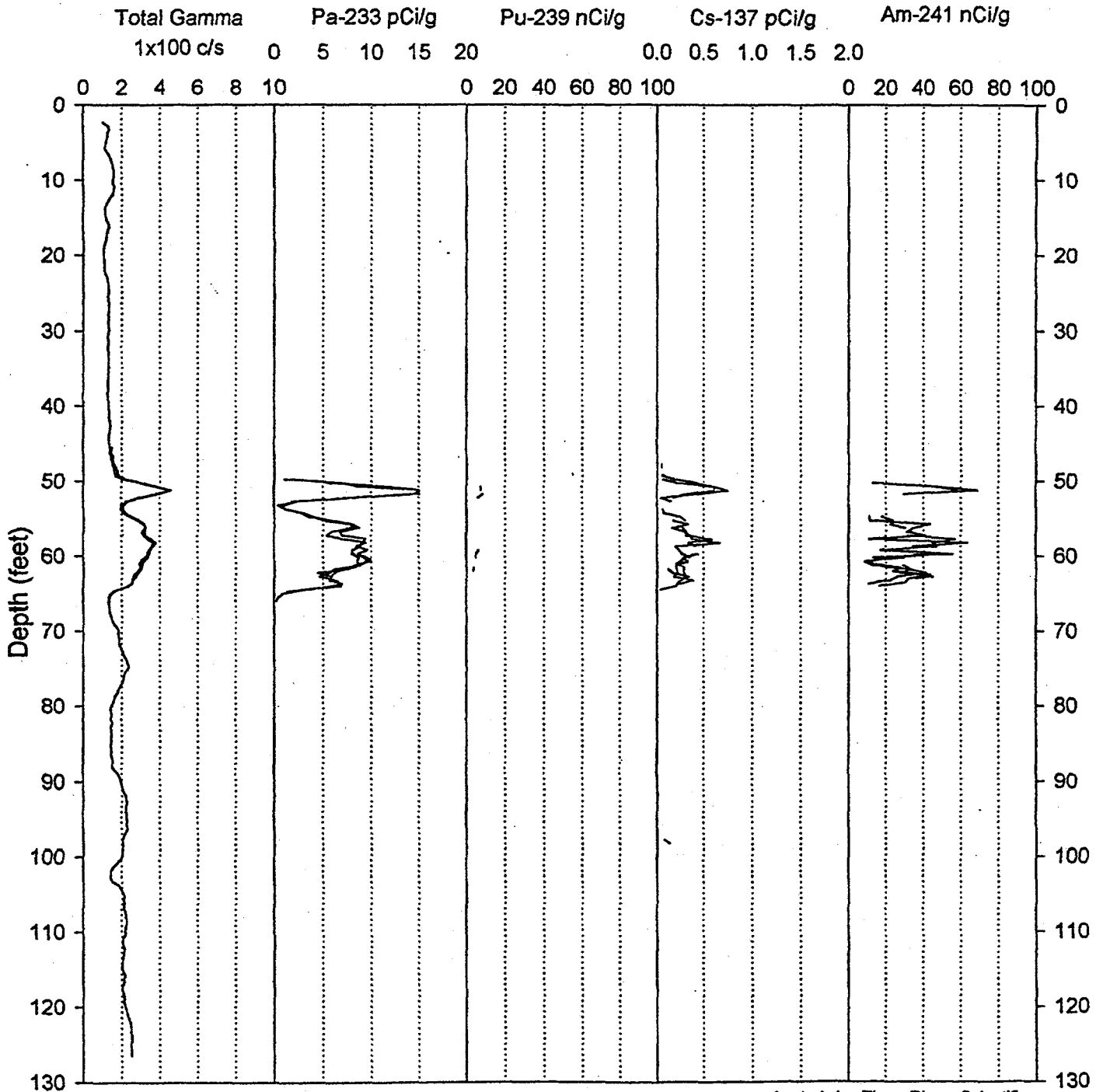
Analysis by: Three Rivers Scientific

# RLS Spectral Gamma Ray Borehole Survey

## Waste Management Federal Services NW

Project: Z Crib Geophysics  
 Borehole: 299-W18-168

Log Date: Mar. 11&18, 1998  
 Man-Made Radionuclides of Concern



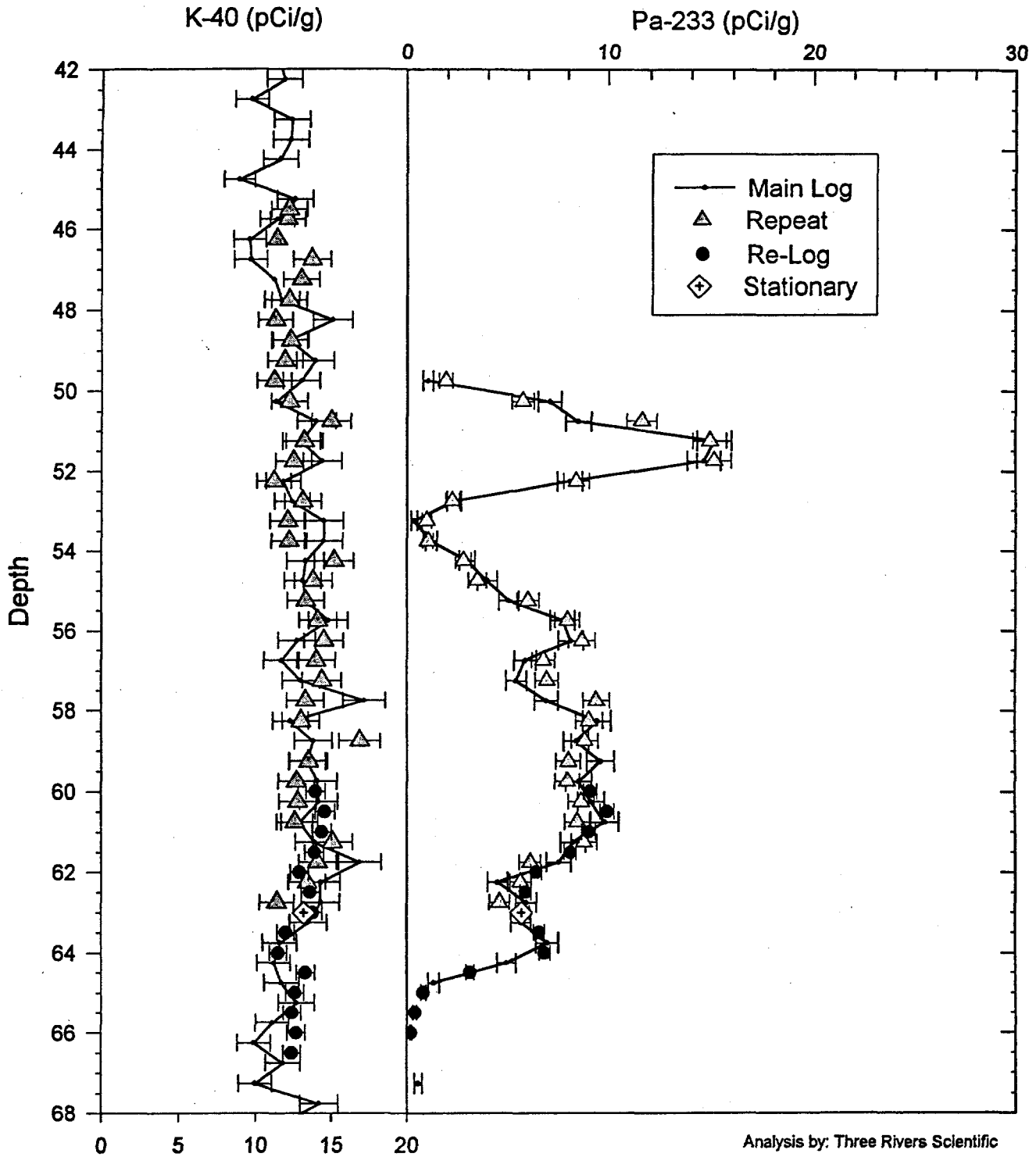
Analysis by: Three Rivers Scientific

# RLS Spectral Gamma Ray Borehole Survey

## Acceptance QA Processing

Project: Z Crib Geophysics  
Borehole: 299-W18-168

Log Date: Mar. 11&18, 1998  
Compare Main Log, Repeat, Re-Log



Analysis by: Three Rivers Scientific

# RLS Spectral Gamma Ray Borehole Survey

Waste Management Federal Services NW

## Log Analysis Summary Report

Project: Z Crib Geophysics  
Log Type: HPGe Spectral Gamma Ray

Well ID: 299-W18-168  
Log Dates: Mar. 11&18, 1998

### General Notes:

Total gamma is, in general, a response of formation lithology, except between the depths of 59 to 64 feet where man-made radionuclides were encountered..

**System Performance Verification:** The pre- and post-log verification was performed using coleman #2 mantle. The maximum FWHM for the 583 keV gamma ray photo peak for both survey dates was 2.19 keV. The maximum acceptable FWHM resolution is 3.10 keV for probe RLSG3.1 on the log dates.

**Repeat Interval:** The repeat interval, 45 to 63 ft, agrees with the main log within acceptable limits (refer to the Acceptance QA Processing plot).

**Environmental Corrections:** The KUT and man-made radionuclide concentrations have been corrected for casing attenuation over the entire well. No casing correction was applied to the total gamma due to Compton downscatter interference. The thorium from 50 to 64 feet is from Tl-208, normally a daughter product of naturally occurring thorium; however, the secular equilibrium is disturbed, indicating that the thorium is not solely due to natural lithology and may be a waste by-product.

### Radionuclides:

Pa-233 exists from 49.5 to 66 feet, with a maximum of 15 pCi/g at 51 feet. Pu-239 exists from 50 to 62 feet at concentrations at or below MDL, based upon a spectral summing technique for the higher sampled re-log data. Am-241 exists from 50 to 64 feet, with a maximum of 70 nCi/g at 51 feet. Cs-137 exists from 49.5 to 64 feet at concentrations less than 1 pCi/g.

	Pa-233	Pu-239	Cs-137	Am-241
max. Concentration	15 pCi/g @ 51 ft	Less than MDL	<1 pCi/g	70 nCi/g @ 51 ft
max. Depth at MDL	64 ft	N/A	64 ft	64 ft
MDL	0.3 pCi/g	N/A	0.1 pCi/g	20 nCi/g

**RLS Spectral Gamma Ray Borehole Survey**  
**Waste Management Federal Services NW**

**Log Header**

Project: Z Crib Geophysics

Well: 299-W18-169

Log Type: HPGe Spectral Gamma Ray

**Borehole Information**

Well ID	<u>A7651</u>	Water Depth	<u>None</u>	Total Depth	<u>128</u> ft
Elevation Reference	<u>Ground Level</u>	Elevation	<u>666</u> ft		
Depth Reference	<u>Top of Casing</u>	Casing Stickup	<u>2.38</u> ft		
Casing Diameter	<u>8</u> in ID	Depth Interval	<u>0 to 128</u> ft	Thickness	<u>0.26</u> in
Casing Diameter	<u>   </u> in	Depth Interval	<u>      </u> ft	Thickness	<u>      </u> in

**Logging Information**

Log Type	HPGe Spectral Gamma Ray	
Company	Waste Management Federal Services NW	
Date/Archive File Name	Mar. 19&25, 1998	H2W18169
Logging Engineers	R. Wilson	
Instrument Series	RLSG3.1	
Logging Unit	RLS2	
Depth Interval	0 to 128 ft	Prefix B177
	35-40 & 60-67	Prefix B183
Instrument Calibration Date	Sep. 9, 1997	
Calibration Report	WHC-SD-EN-TI-292, Rev. 0	

**Analysis Information**

Company	Three Rivers Scientific
Analyst	Russ Randall
Date	April 3, 1998

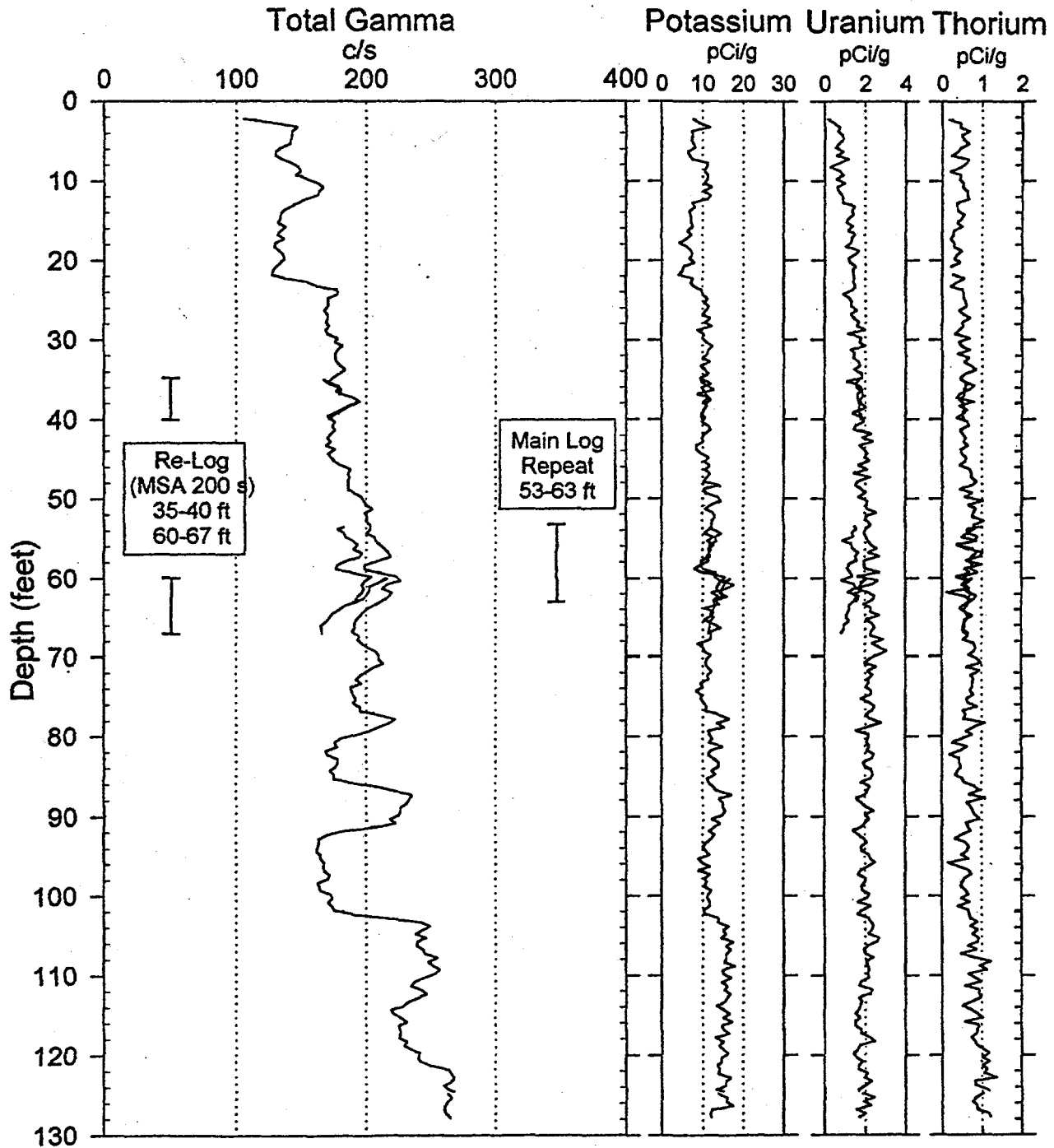
Notes Pa-233 identified at 38 feet with a maximum concentration of 1.3 pCi/g. No other man-made radionuclides were detected. The concentration of Pa-233 is at MDL for the screening pass, but above the re-log MDL-value, due to increased sample time.

# RLS Spectral Gamma Ray Borehole Survey

## Waste Management Federal Services NW

Project: Z Crib Geophysics  
Borehole: 299-W18-169

Log Date: Mar. 19 & 25, 1998  
Naturally Occurring Radionuclides



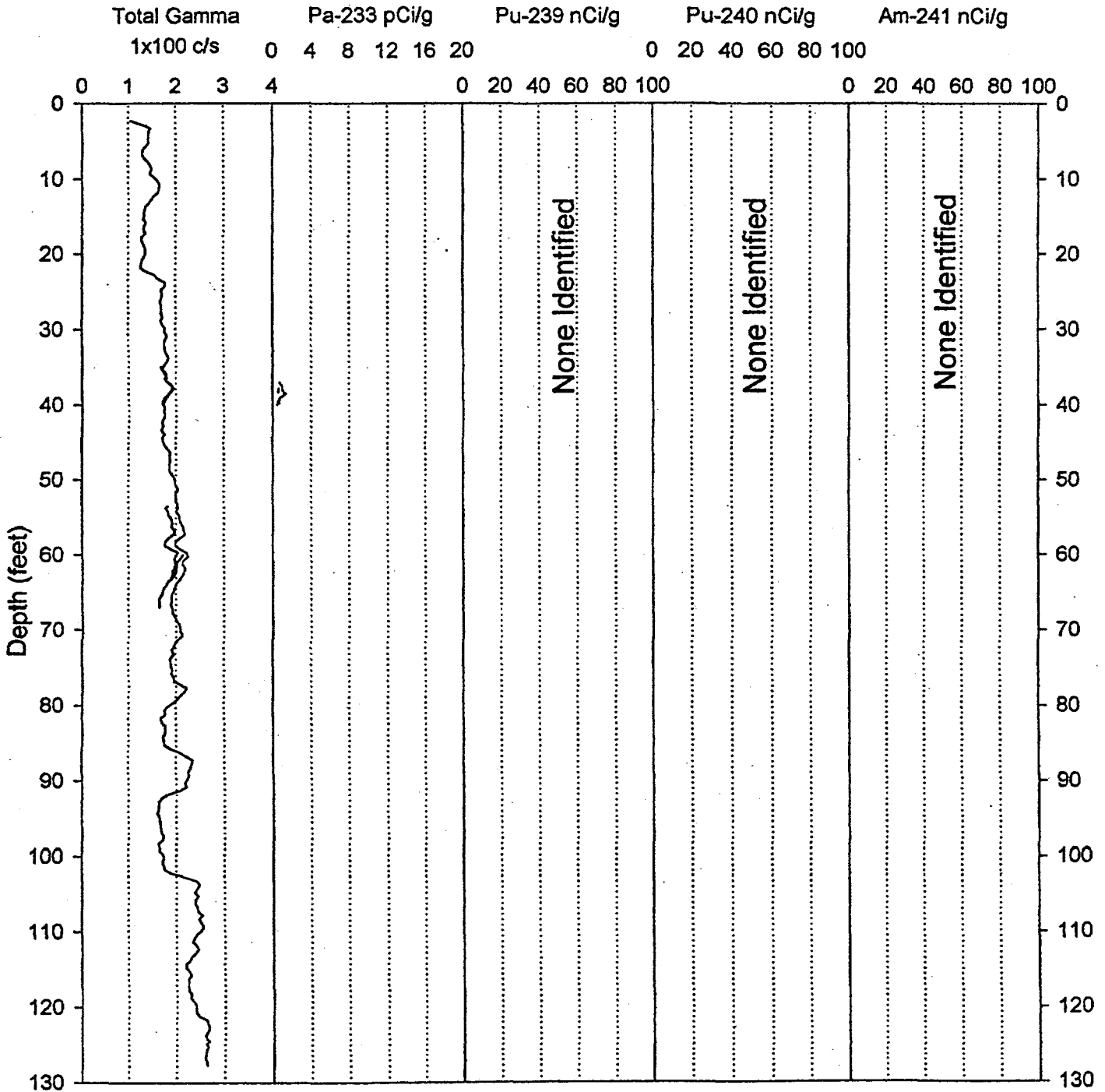
Analysis by: Three Rivers Scientific

# RLS Spectral Gamma Ray Borehole Survey

## Waste Management Federal Services NW

Project: Z Crib Geophysics  
 Borehole: 299-W18-169

Log Date: Mar. 19 & 25, 1998  
 Man-Made Radionuclides of Concern

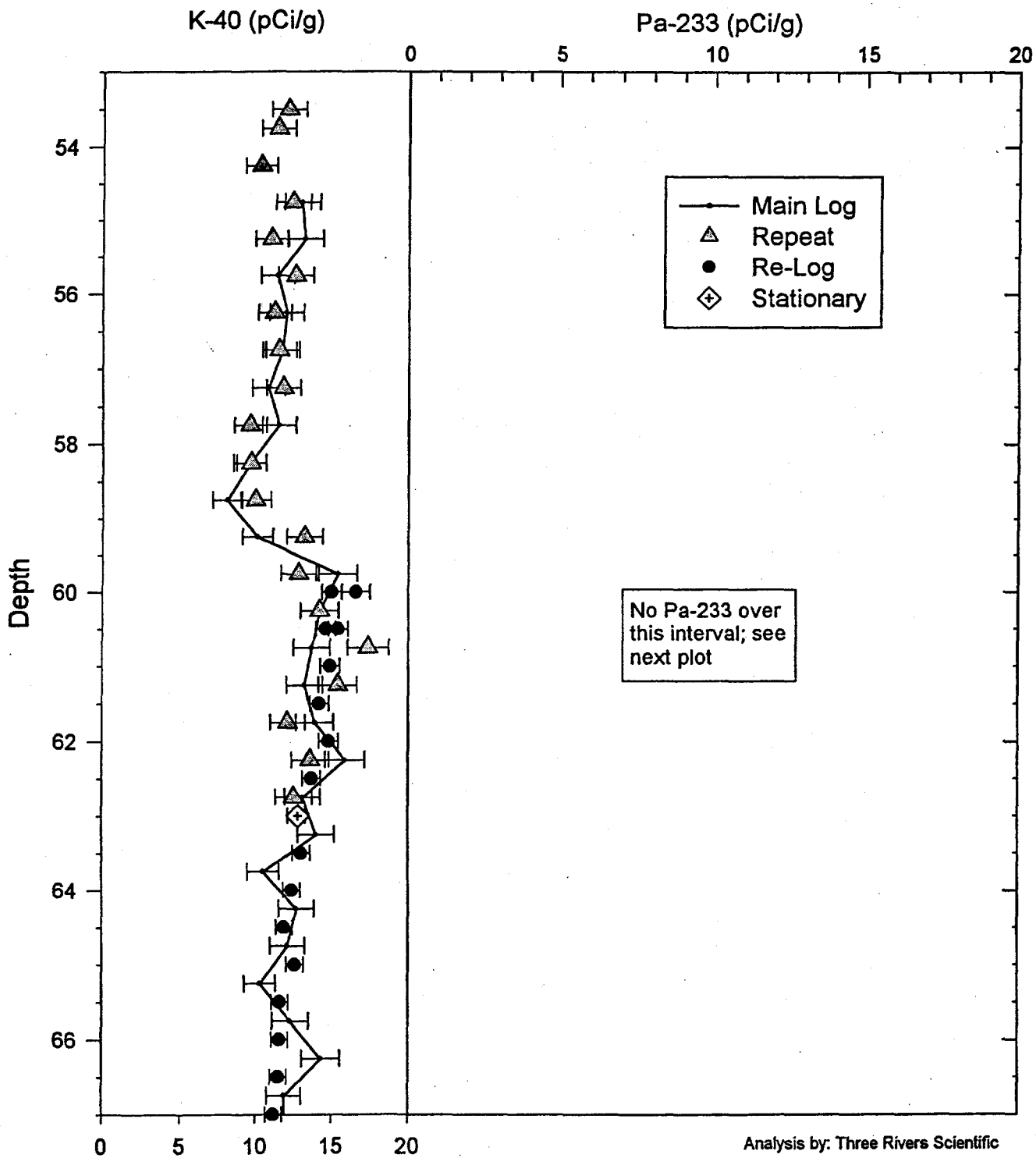


# RLS Spectral Gamma Ray Borehole Survey

## Acceptance QA Processing

Project: Z Crib Geophysics  
Borehole: 299-W18-169

Log Date: Mar. 19 & 25, 1998  
Compare Main Log, Repeat, Re-Log



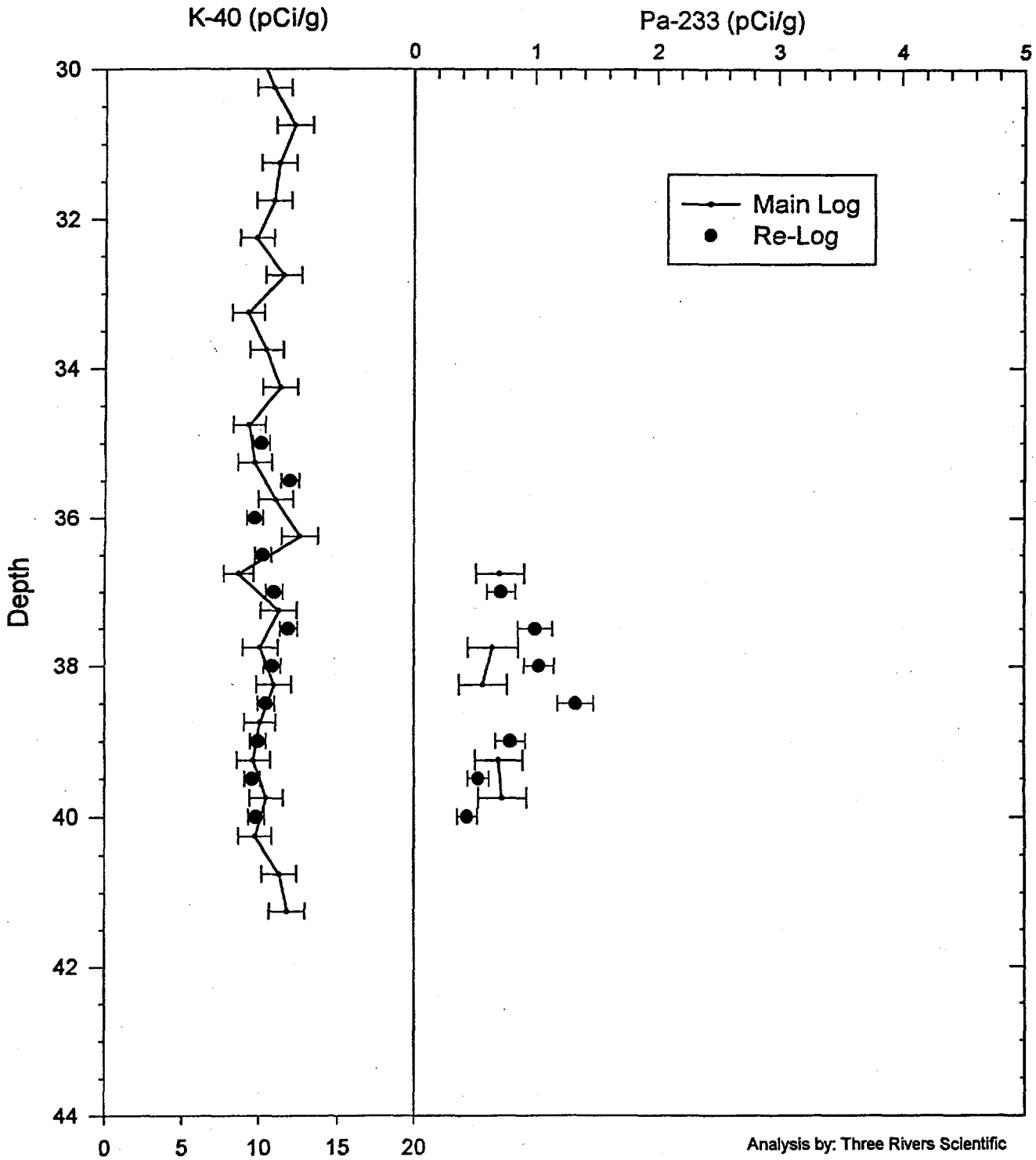
Analysis by: Three Rivers Scientific

# RLS Spectral Gamma Ray Borehole Survey

## Acceptance QA Processing

Project: Z Crib Geophysics  
Borehole: 299-W18-169

Log Date: Mar. 19 & 25, 1998  
Compare Main Log and Re-Log  
for deeper interval



Analysis by: Three Rivers Scientific

**RLS Spectral Gamma Ray Borehole Survey**  
Waste Management Federal Services NW

**Log Analysis Summary Report**

Project: Z Crib Geophysics  
Log Type: HPGe Spectral Gamma Ray

Well ID: 299-W18-169  
Log Dates: Mar. 19&25, 1998

**General Notes:**

Total gamma is, in general, a response of formation lithology.

**System Performance Verification:** The pre- and post-log verification was performed using coleman #2 mantle. The maximum FWHM for the 583 keV gamma ray photo peak for both survey dates was 2.38 keV. The maximum acceptable FWHM resolution is 3.10 keV for probe RLSG3.1 on the log dates.

**Repeat Interval:** The repeat interval, 53 to 63 ft, agrees with the main log within acceptable limits (refer to the Acceptance QA Processing plot). Gross gamma does not repeat due to radon pumping see following section; however, the other nuclides do repeat.

**Radon Pumping:** Low barometric pressure permits free radon-222 in the formation to vent up the borehole, creating additional uranium gamma-ray daughters inside the casing that add to the logging signal. The high apparent uranium concentrations during low barometric pressure vents will not agree with formation gamma-ray activity when radon is not venting up boreholes. The repeat gross is systematically different from the 1<sup>st</sup> pass, but the difference is due only to the apparent uranium concentration change.

**Environmental Corrections:** The KUT and man-made radionuclide concentrations have been corrected for casing attenuation over the entire well. No casing correction was applied to the total gamma due to Compton downscatter interference.

**Radionuclides:**

Pa-233 was the only man made radionuclide identified in the well log data. Detection was at MDL during the screening pass, but above MDL during the re-log data collection. Pa-233 reached a maximum of 1.3 pCi/g at a depth of 38 ft. The maximum depth observed for Pa-233 (at MDL for this well configuration) is 40 feet for the re-log data set (MSA 200 seconds live-time). The MDL for this depth in the re-log is near 0.7 pCi/g.

	<b>Pa-233</b>
<b>max. Concentration</b>	1.3 pCi/g @ 38 ft
<b>max. Depth at MDL</b>	40 ft
<b>MDL</b>	0.7 pCi/g

# RLS Spectral Gamma Ray Borehole Survey

## Waste Management Federal Services NW

### Log Header

Project: Z Crib Geophysics

Well: 299-W18-173

Log Type: HPGe Spectral Gamma Ray

#### Borehole Information

Well ID	A7655	Water Depth	None	Total Depth	45	ft
Elevation Reference	Top of Casing	Elevation	673.3			ft
Depth Reference	Top of Casing	Casing Stickup	2.12			ft
Casing Diameter	8 in ID	Depth Interval	0 to 45	Thickness	0.28	in
Casing Diameter	in	Depth Interval		Thickness		in

#### Logging Information

Log Type	HPGe Spectral Gamma Ray	
Company	Waste Management Federal Services NW	
Date/Archive File Name	Mar. 26, 1998	H2W18173
Logging Engineers	R. Wilson	
Instrument Series	RLSG3.1	
Logging Unit	RLS2	
Depth Interval	0 to 44 ft	Prefix B184
Instrument Calibration Date	Sep. 9, 1997	
Calibration Report	WHC-SD-EN-TI-292, Rev. 0	

#### Analysis Information

Company	Three Rivers Scientific
Analyst	Randall Price
Date	April 7, 1998

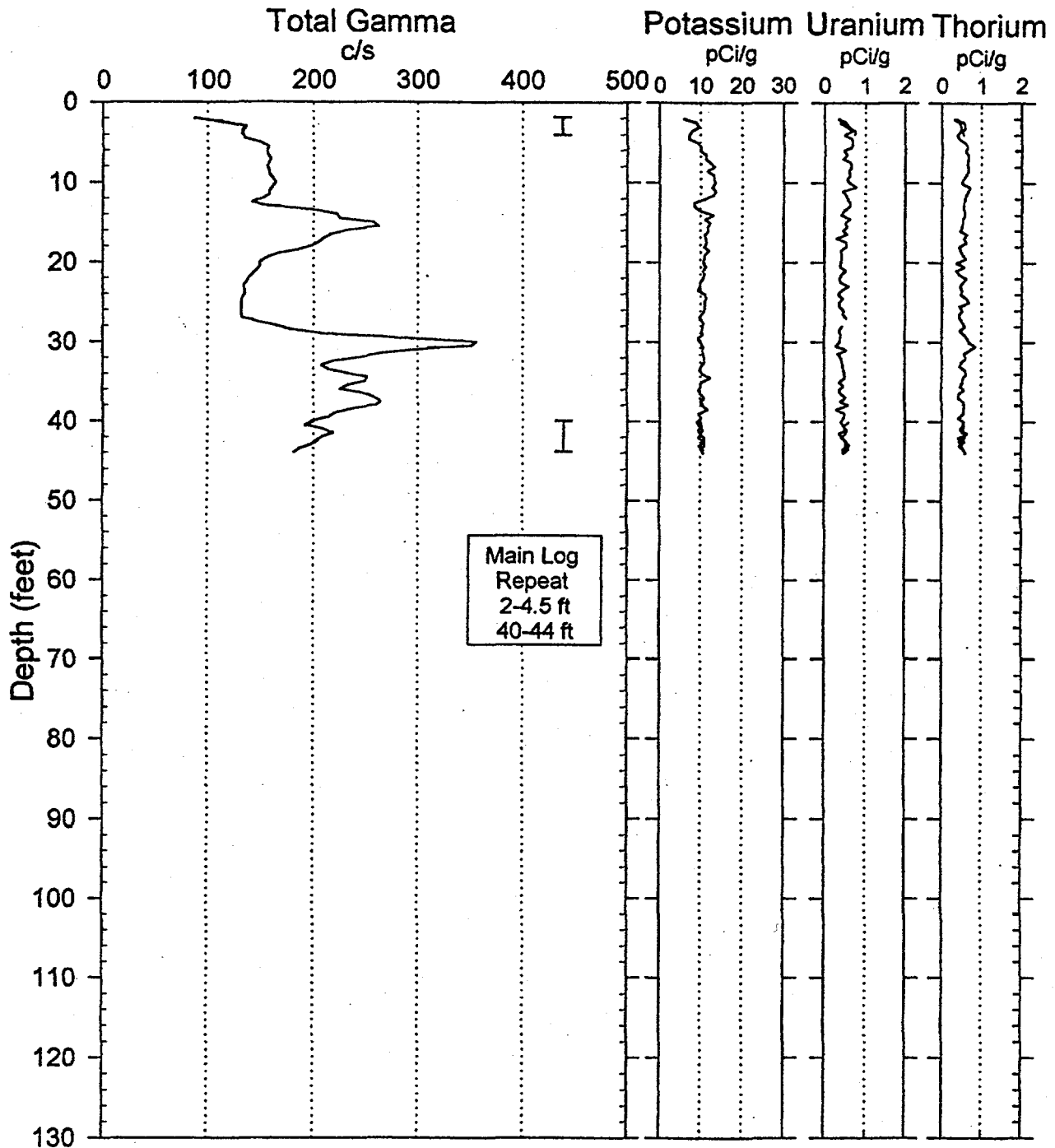
Notes Pa-233 exists in two zones: 13 to 25 and 27 to 44 feet, with a maximum of 7 pCi/g at 30.5 feet. Pu-239 exists in three zones: 13.5 to 18, 30 to 31, and 42 to 44 feet, with a maximum of 34 nCi/g at 15 feet. Am-241 exists in three zones: 14 to 16, 29.5 to 32, and 35 to 40 feet, with a maximum of 80 nCi/g at 30.5 feet. Cs-137 exists in three zones: 3 to 6.5, 15 to 16, and 29 to 42 feet, with a maximum less than 1 pCi/g.

# RLS Spectral Gamma Ray Borehole Survey

## Waste Management Federal Services NW

Project: Z Crib Geophysics  
Borehole: 299-W18-173

Log Date: Mar. 26, 1998  
Naturally Occurring Radionuclides



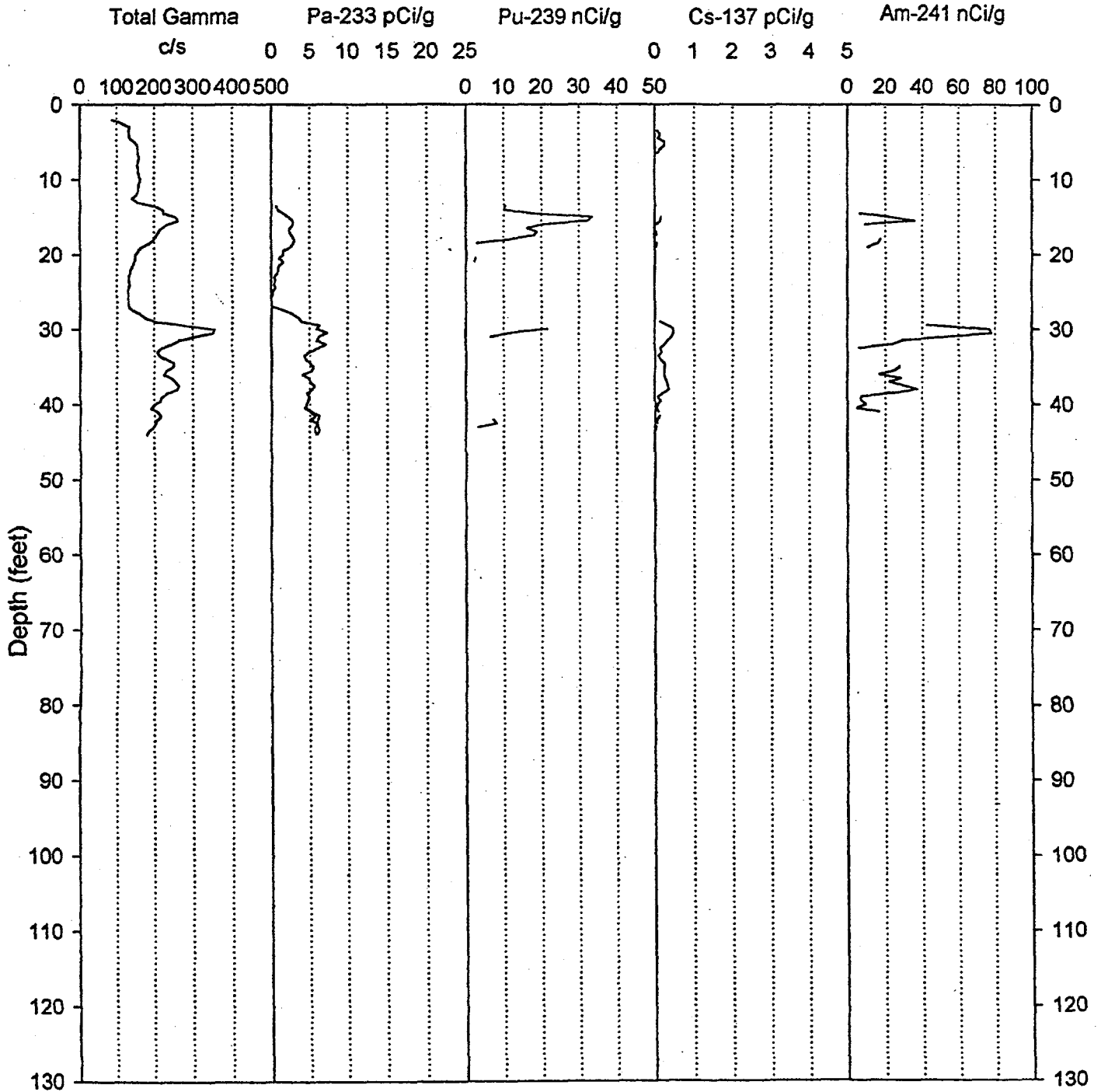
Analysis by: Three Rivers Scientific

# RLS Spectral Gamma Ray Borehole Survey

## Waste Management Federal Services NW

Project: Z Crib Geophysics  
Borehole: 299-W18-173

Log Date: Mar. 26, 1998  
Man-Made Radionuclides of Concern

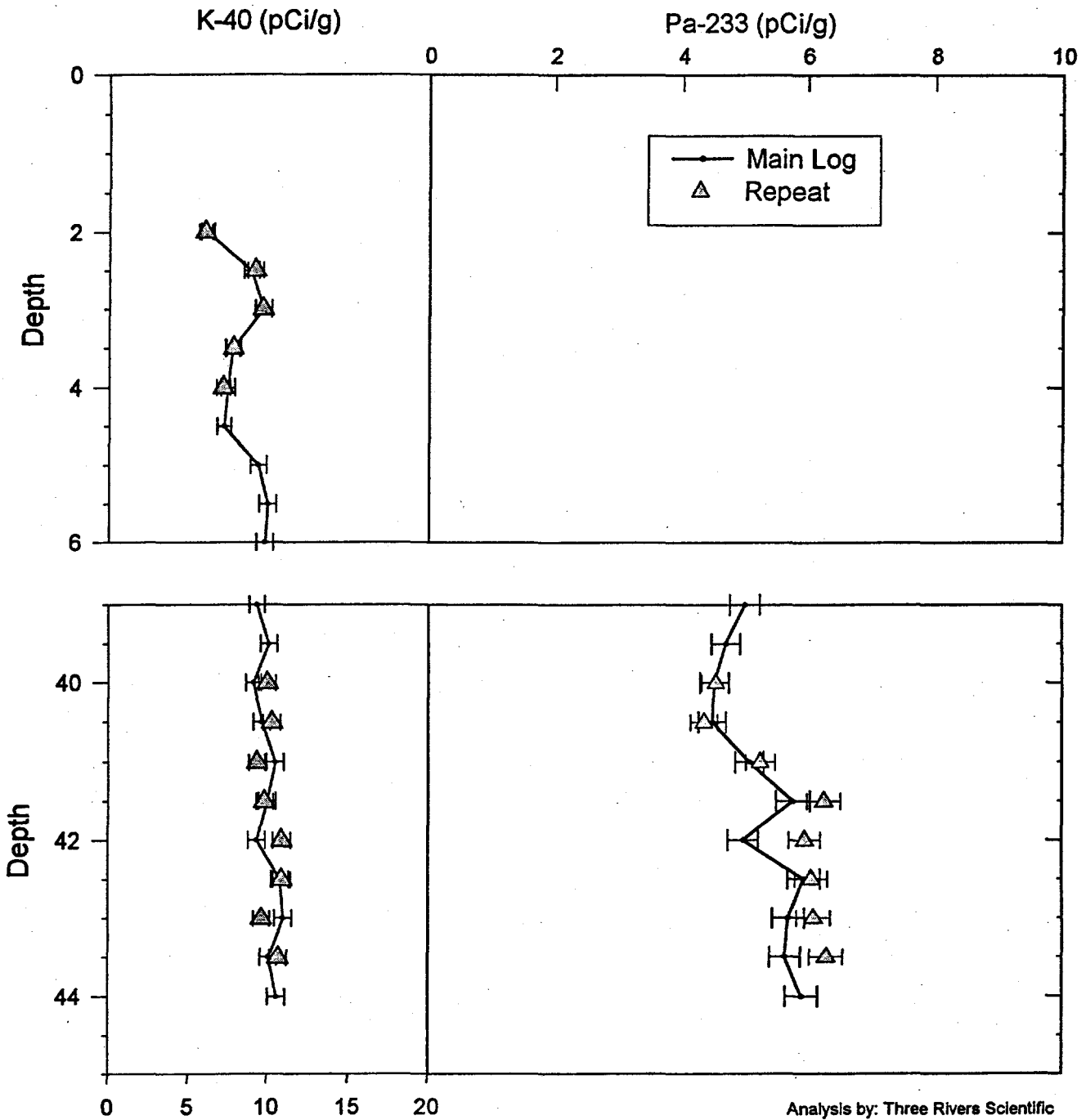


# RLS Spectral Gamma Ray Borehole Survey

## Acceptance QA Processing

Project: Z Crib Geophysics  
 Borehole: 299-W18-173

Log Date: Mar. 26, 1998  
 Compare Main Log and Repeat



Analysis by: Three Rivers Scientific

# RLS Spectral Gamma Ray Borehole Survey

## Waste Management Federal Services NW

### Log Analysis Summary Report

Project: Z Crib Geophysics  
 Log Type: HPGe Spectral Gamma Ray

Well ID: 299-W18-173  
 Log Dates: Mar. 26, 1998

**General Notes:**

Total gamma is a response to man-made gamma ray emitters from surface to the maximum survey depth of 44 feet.

**System Performance Verification:** The pre- and post-log verification was performed using coleman #2 mantle. The maximum FWHM for the 583 keV gamma ray photo peak was 2.31 keV. The maximum acceptable FWHM resolution is 3.10 keV for probe RLSG3.1 on the log date.

**Repeat Interval:** The repeat intervals, 2 to 4.5 feet and 40 to 44 feet, agree with the main log within acceptable limits (refer to the Acceptance QA Processing plot).

**Environmental Corrections:** The KUT and man-made radionuclide concentrations have been corrected for casing attenuation over the entire well. No casing correction was applied to the total gamma due to Compton downscatter interference.

**Radionuclides:**

Pa-233 exists in two zones: 13 to 25 and 27 to 44 feet, with a maximum of 7 pCi/g at 30.5 feet. Pu-239 exists in three zones: 13.5 to 18, 30 to 31, and 42 to 44 feet, with a maximum of 34 nCi/g at 15 feet. Am-241 exists in three zones: 14 to 16, 29.5 to 32, and 35 to 40 feet, with a maximum of 80 nCi/g at 30.5 feet. Cs-137 exists in three zones: 3 to 6.5, 15 to 16, and 29 to 42 feet, with a maximum less than 1 pCi/g.

	Pa-233	Pu-239	Cs-137	Am-241
max. Concentration	7 pCi/g @ 30.5 ft	34 nCi/g @ 15 ft	<1 pCi/g	80 nCi/g @ 30.5 ft
max. Depth at MDL	44 ft	43 ft	41.5 ft	40 ft
MDL	0.3 pCi/g	5 nCi/g	0.1 pCi/g	10 nCi/g

# RLS Spectral Gamma Ray Borehole Survey

## Waste Management Federal Services NW

### Log Header

Project: Z Crib Geophysics

Well: 299-W18-175

Log Type: HPGe Spectral Gamma Ray

#### Borehole Information

Well ID	<u>A7657</u>	Water Depth	<u>None</u>	Total Depth	<u>121</u> ft
Elevation Reference	<u>Ground Level</u>	Elevation	<u>667.1</u> ft		
Depth Reference	<u>Top of Casing</u>	Casing Stickup	<u>2.15</u> ft		
Casing Diameter	<u>6</u> in ID	Depth Interval	<u>0 to 121</u> ft	Thickness	<u>0.31</u> in
Casing Diameter	<u>   </u> in	Depth Interval	<u>          </u> ft	Thickness	<u>          </u> in

#### Logging Information

Log Type	HPGe Spectral Gamma Ray	
Company	Waste Management Federal Services NW	
Date/Archive File Name	Mar. 20&27, 1998	H2W18175
Logging Engineers	R. Wilson	
Instrument Series	RLSG3.1	
Logging Unit	RLS2	
Depth Interval	2 to 121 ft	Prefix B178
	94 to 101 ft	Prefix B185
Instrument Calibration Date	Sep. 9, 1997	
Calibration Report	WHC-SD-EN-TI-292, Rev. 0	

#### Analysis Information

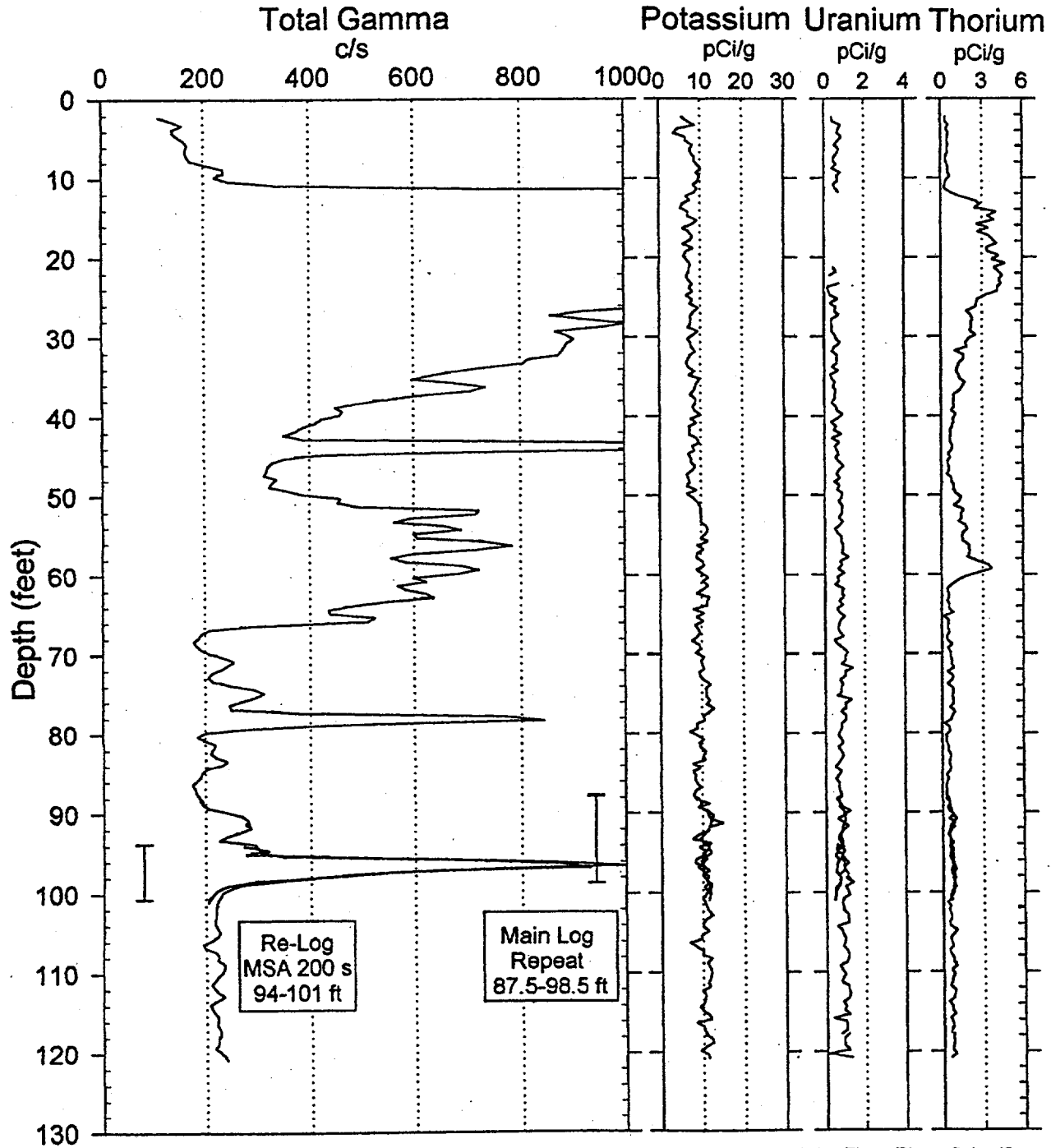
Company	Three Rivers Scientific
Analyst	Randall Price
Date	April 7, 1998
Notes	<p>Pa-233 exists in two zones: 12 to 69 and 74 to 99 feet, with a maximum of 24 pCi/g at 14.5 feet. Pu-239 exists in two zones: 12 to 69 and 74 to 99 feet, with a maximum of 6,600 nCi/g at 14.5 feet. Am-241 exists in three zones: 12 to 66, 77 to 79, and 94 to 97 feet, with a maximum of 800 nCi/g at 14.5 feet. Cs-137 exists in three zones: 11 to 66, 77 to 79, and 92 to 98 feet, with a maximum of 8 pCi/g at 14.5 feet. The Am-241 is relative and not absolute due to moderate interference from other photo peaks. Pu-240 is also likely, but the severe interference rules out any possibility of quantification. No other man-made radionuclides were detected; however, many other fission and neutron induced gamma rays are present.</p>

# RLS Spectral Gamma Ray Borehole Survey

## Waste Management Federal Services NW

Project: Z Crib Geophysics  
 Borehole: 299-W18-175

Log Date: Mar. 20 & 27, 1998  
 Naturally Occurring Radionuclides



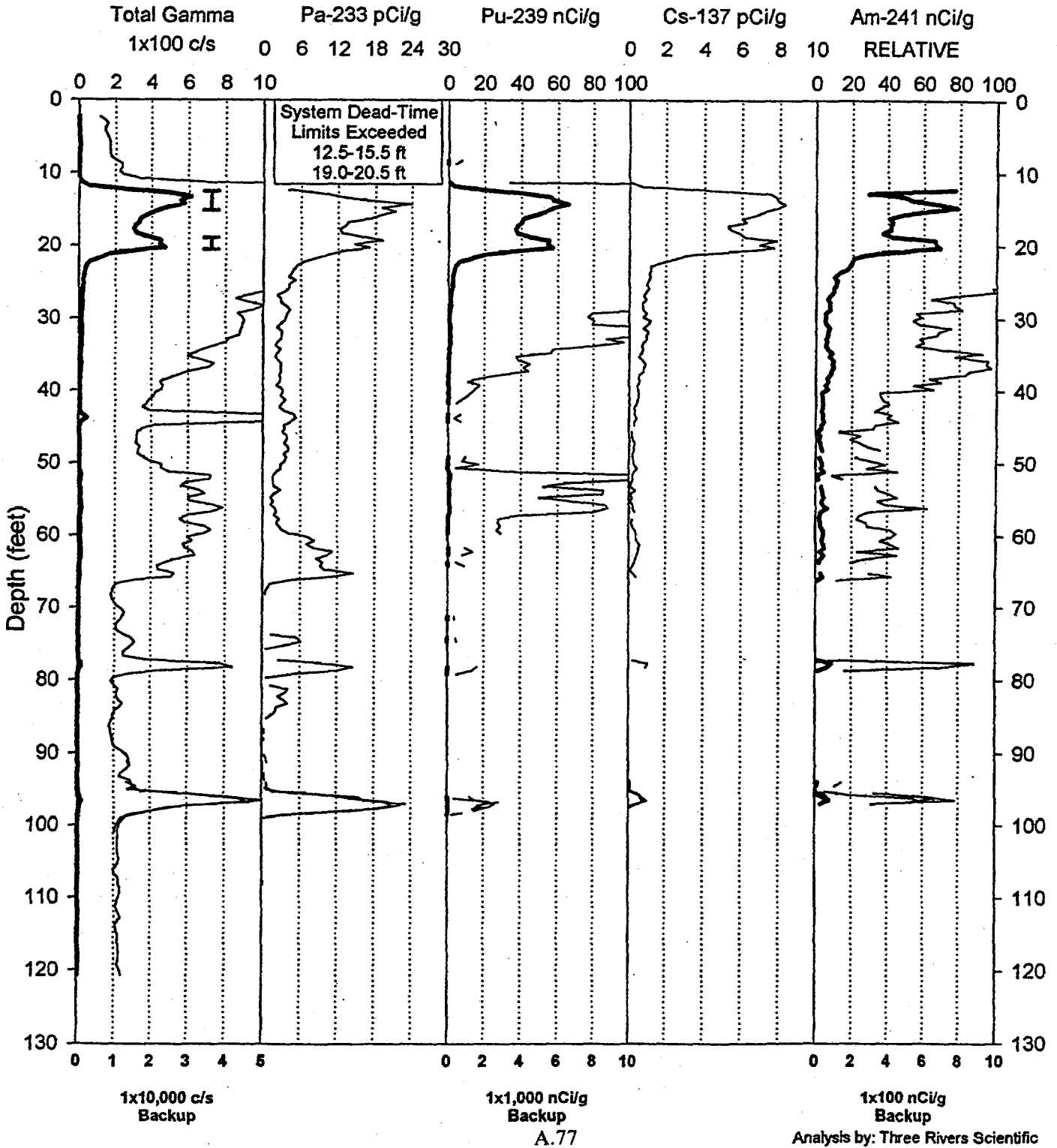
Analysis by: Three Rivers Scientific

# RLS Spectral Gamma Ray Borehole Survey

## Waste Management Federal Services NW

Project: Z Crib Geophysics  
 Borehole: 299-W18-175

Log Date: Mar. 20 & 27, 1998  
 Man-Made Radionuclides of Concern

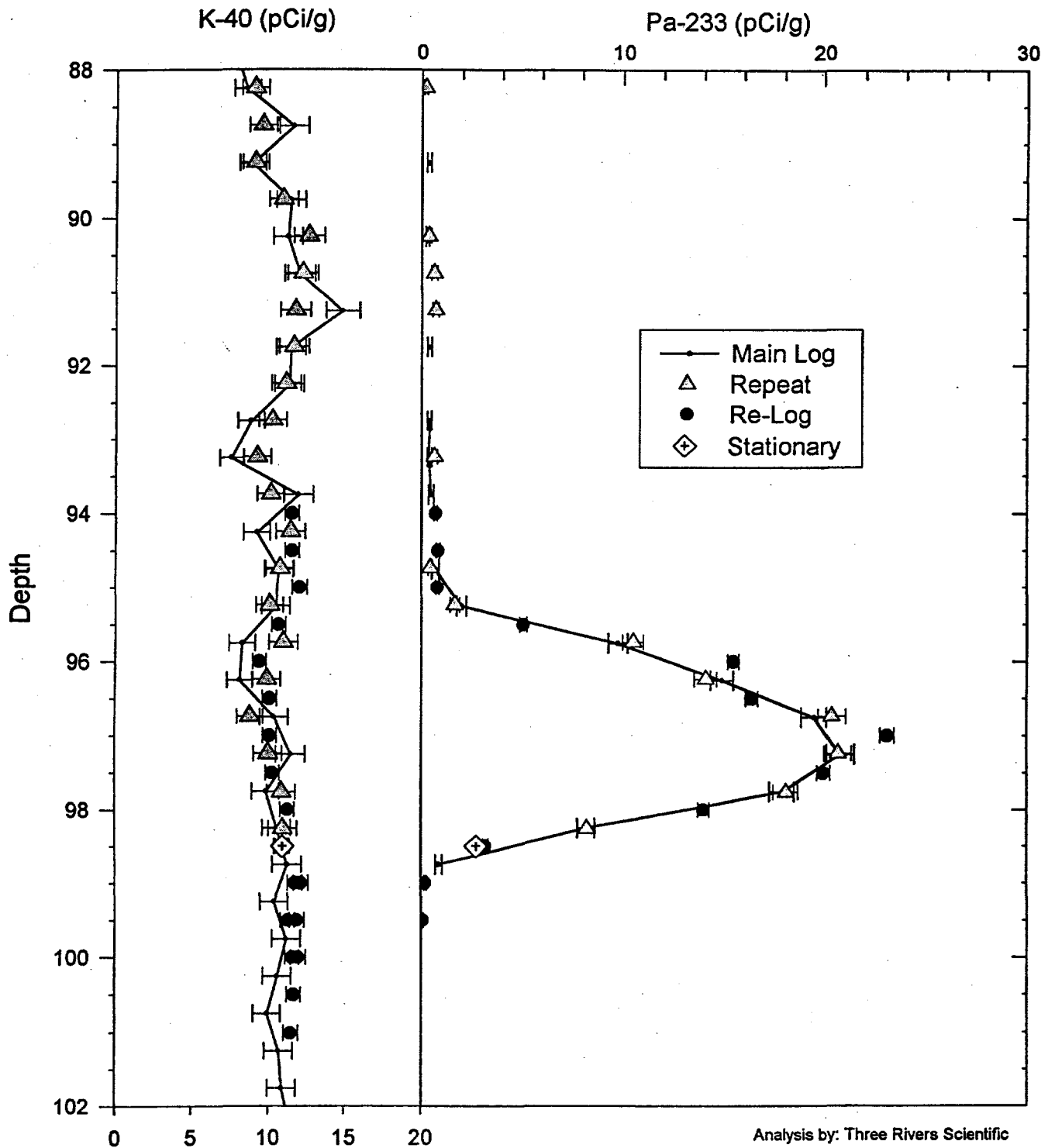


# RLS Spectral Gamma Ray Borehole Survey

## Acceptance QA Processing

Project: Z Crib Geophysics  
Borehole: 299-W18-175

Log Date: Mar. 20 & 27, 1998  
Compare Main Log, Repeat, Re-Log



Analysis by: Three Rivers Scientific

# RLS Spectral Gamma Ray Borehole Survey

Waste Management Federal Services NW

## Log Analysis Summary Report

Project: Z Crib Geophysics  
Log Type: HPGe Spectral Gamma Ray

Well ID: 299-W18-175  
Log Dates: Mar. 20&27, 1998

### General Notes:

Total gamma is a response to man-made gamma ray emitters from surface to 100 feet, and a function of formation lithology below 100 feet.

**System Performance Verification:** The pre- and post-log verification was performed using coleman #2 mantle. The maximum FWHM for the 583 keV gamma ray photo peak for both survey dates was 2.54 keV. The maximum acceptable FWHM resolution is 3.10 keV for probe RLSG3.1 on the log dates.

**Repeat Interval:** The repeat interval, 87.5 to 98.5 feet, agrees with the main log within acceptable limits (refer to the Acceptance QA Processing plot).

**Environmental Corrections:** The KUT and man-made radionuclide concentrations have been corrected for casing attenuation over the entire well. No casing correction was applied to the total gamma due to Compton downscatter interference. The thorium from 8 to 62 feet is from Tl-208, normally a daughter product of naturally occurring thorium; however, the secular equilibrium is greatly disturbed, indicating that the thorium is not solely due to natural lithology and may be a waste by-product.

### Radionuclides:

Pa-233 exists in two zones: 12 to 69 and 74 to 99 feet, with a maximum of 24 pCi/g at 14.5 feet. Pu-239 exists in two zones: 12 to 69 and 74 to 99 feet, with a maximum of 6,600 nCi/g at 14.5 feet. Am-241 exists in three zones: 12 to 66, 77 to 79, and 94 to 97 feet, with a maximum of 800 nCi/g at 14.5 feet. Cs-137 exists in three zones: 11 to 66, 77 to 79, and 92 to 98 feet, with a maximum of 8 pCi/g at 14.5 feet. The Am-241 is relative and not absolute due to moderate interference from other photo peaks. Pu-240 is also likely, but the severe interference rules out any possibility of quantification. No other man-made radionuclides were detected; however, many other fission and neutron induced gamma rays are present.

The system dead-time limit was exceeded between 12.5-15.5 feet and 19-20.5 feet which prevented accurate measurement of the radionuclide concentrations. The log response over these intervals is relative. The high degree of variance of Pu-239 and Am-241 over the interval 45 to 65 feet is real, and not an artifact of the processing, even though the processing is adversely affected by other photo peaks.

	Pa-233	Pu-239	Cs-137	Am-241
max. Concentration	24 pCi/g @14.5 ft	6,600 nCi/g @ 14.5 ft	8 pCi/g @ 14.5 ft	800 nCi/g @ 14.5 ft
max. Depth at MDL	99 ft	98 ft	97 ft	97 ft
MDL	0.5 pCi/g	15 nCi/g	0.2 pCi/g	30 nCi/g

# RLS Spectral Gamma Ray Borehole Survey

## Waste Management Federal Services NW

### Log Header

Project: Z Crib Geophysics

Well: 299-W18-179

Log Type: HPGe Spectral Gamma Ray

#### Borehole Information

Well ID	A7661	Water Depth	None	Total Depth	39.5 ft
Elevation Reference	No Data	Elevation	No Data		
Depth Reference	Top of Casing	Casing Stickup	2.38 ft		
Casing Diameter	6 in ID	Depth Interval	0 to 39.5 ft	Thickness	0.22 in
Casing Diameter	in	Depth Interval	ft	Thickness	in

#### Logging Information

Log Type	HPGe Spectral Gamma Ray	
Company	Waste Management Federal Services NW	
Date/Archive File Name	Mar. 30, 1998 H2W18179	
Logging Engineers	R. Wilson	
Instrument Series	RLSG3.1	
Logging Unit	RLS2	
Depth Interval	0 to 38.5 ft	Prefix B189
Instrument Calibration Date	Sep. 9, 1997	
Calibration Report	WHC-SD-EN-TI-292, Rev. 0	

#### Analysis Information

Company	Three Rivers Scientific
Analyst	Russ Randall
Date	March 31, 1998

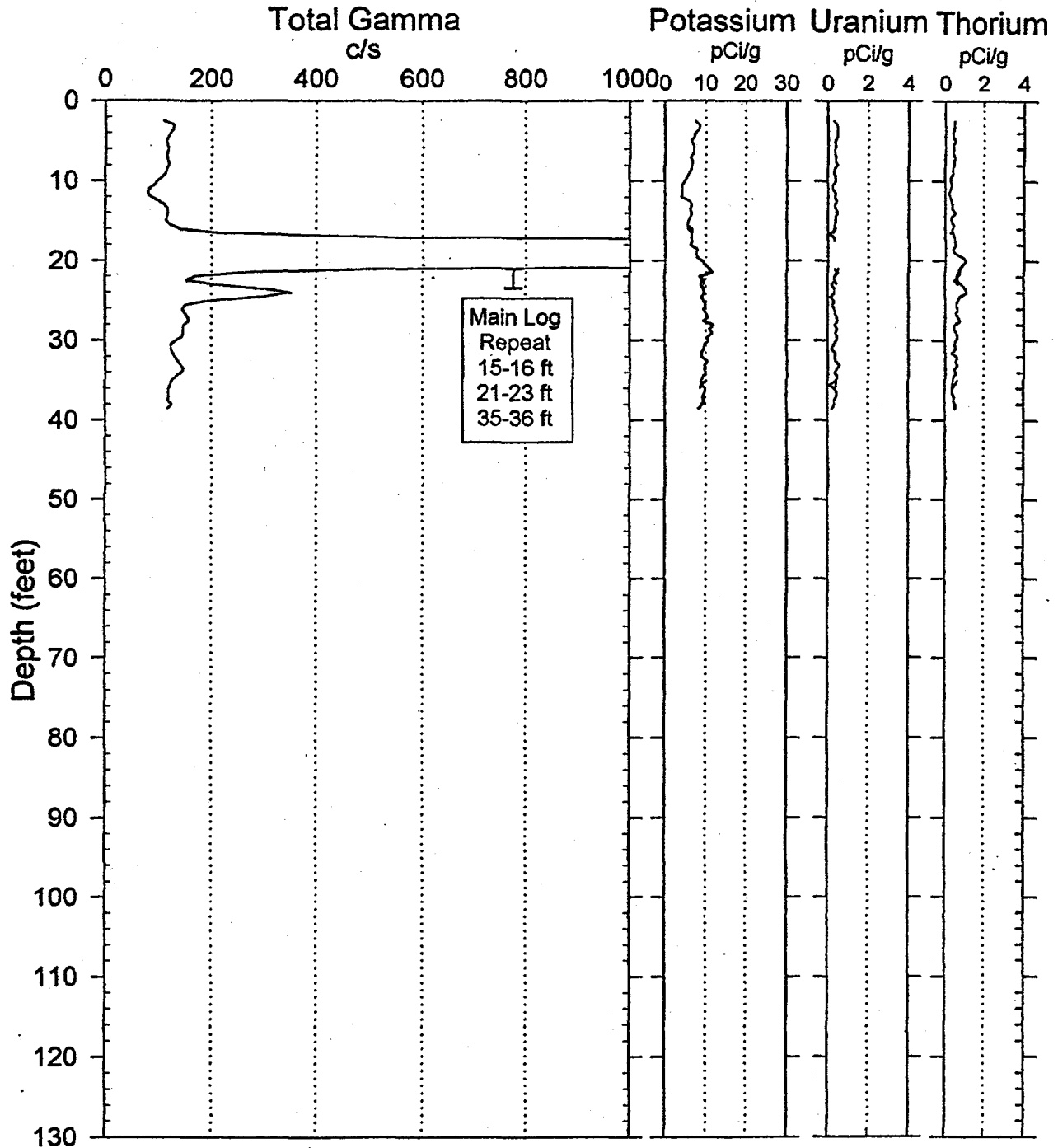
**Notes** Cs-137 exists from 17 to 21.5 feet, with a maximum of 900 pCi/g at 19 feet. Pu-239 exists in two zones at 19 and 24 feet, with a maximum of 700 nCi/g at 19.5 feet. (Note the Pu-239 signal in portions of the 19 foot zone is masked by the high Cs-137 signal, and likewise for the Pa-233 signal.) Pa-233 exists in both the zones at 19 feet and 24 feet, with a maximum of 36 pCi/g at 19.5 feet. Natural thorium is in secular dis-equilibrium in the two zone at 19 and 24 feet, but the 19 ft interval is somewhat masked by the strong Cs-137 signal. Am-241 is observed, but the levels are too low with the high Cs-137, leaving no calculations possible for Am-241. No other man-made radionuclides were detected.

# RLS Spectral Gamma Ray Borehole Survey

## Waste Management Federal Services NW

Project: Z Crib Geophysics  
Borehole: 299-W18-179

Log Date: Mar. 30, 1998  
Naturally Occurring Radionuclides



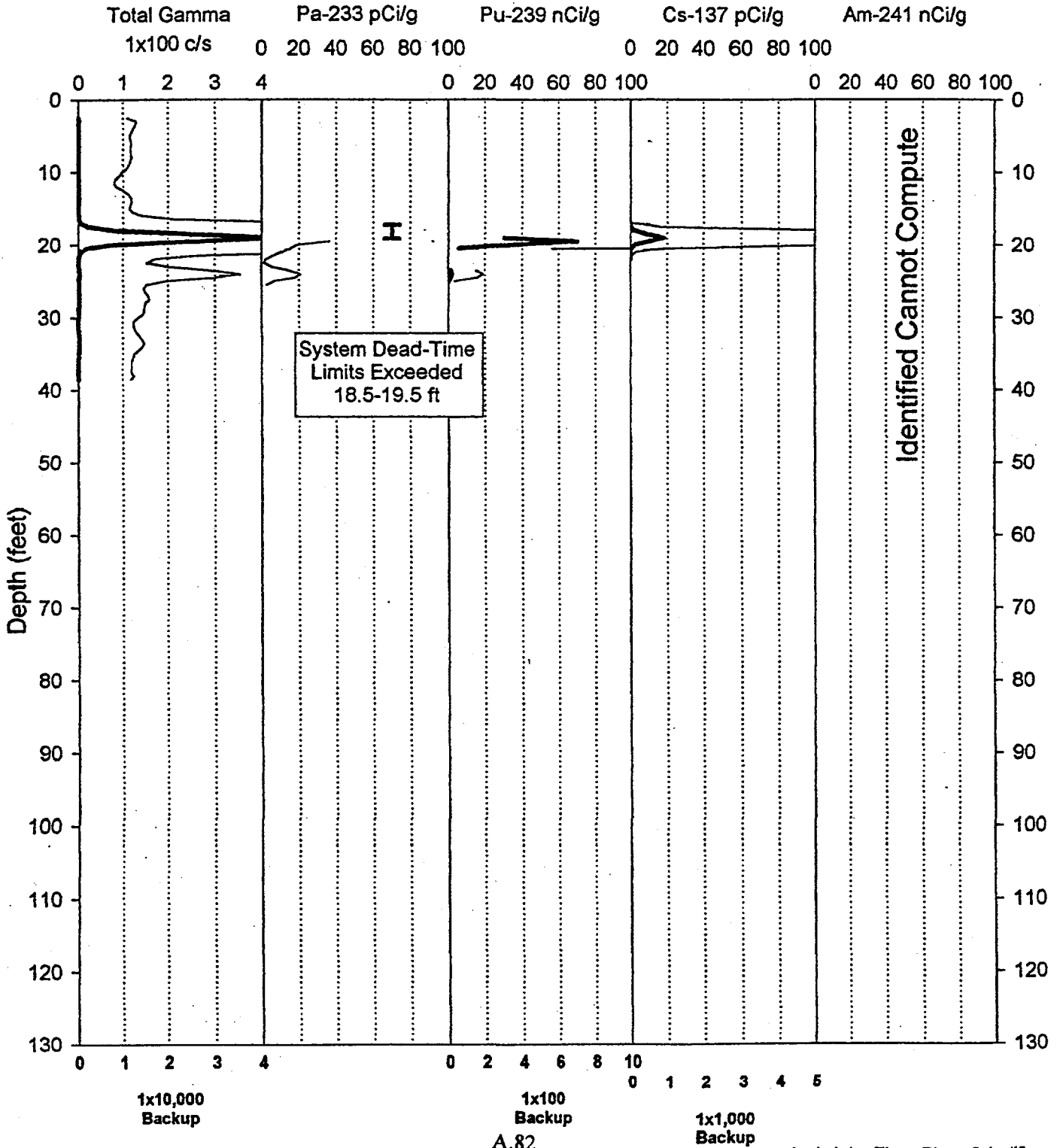
Analysis by: Three Rivers Scientific

# RLS Spectral Gamma Ray Borehole Survey

## Waste Management Federal Services NW

Project: Z Crib Geophysics  
 Borehole: 299-W18-179

Log Date: Mar. 30, 1998  
 Man-Made Radionuclides of Concern

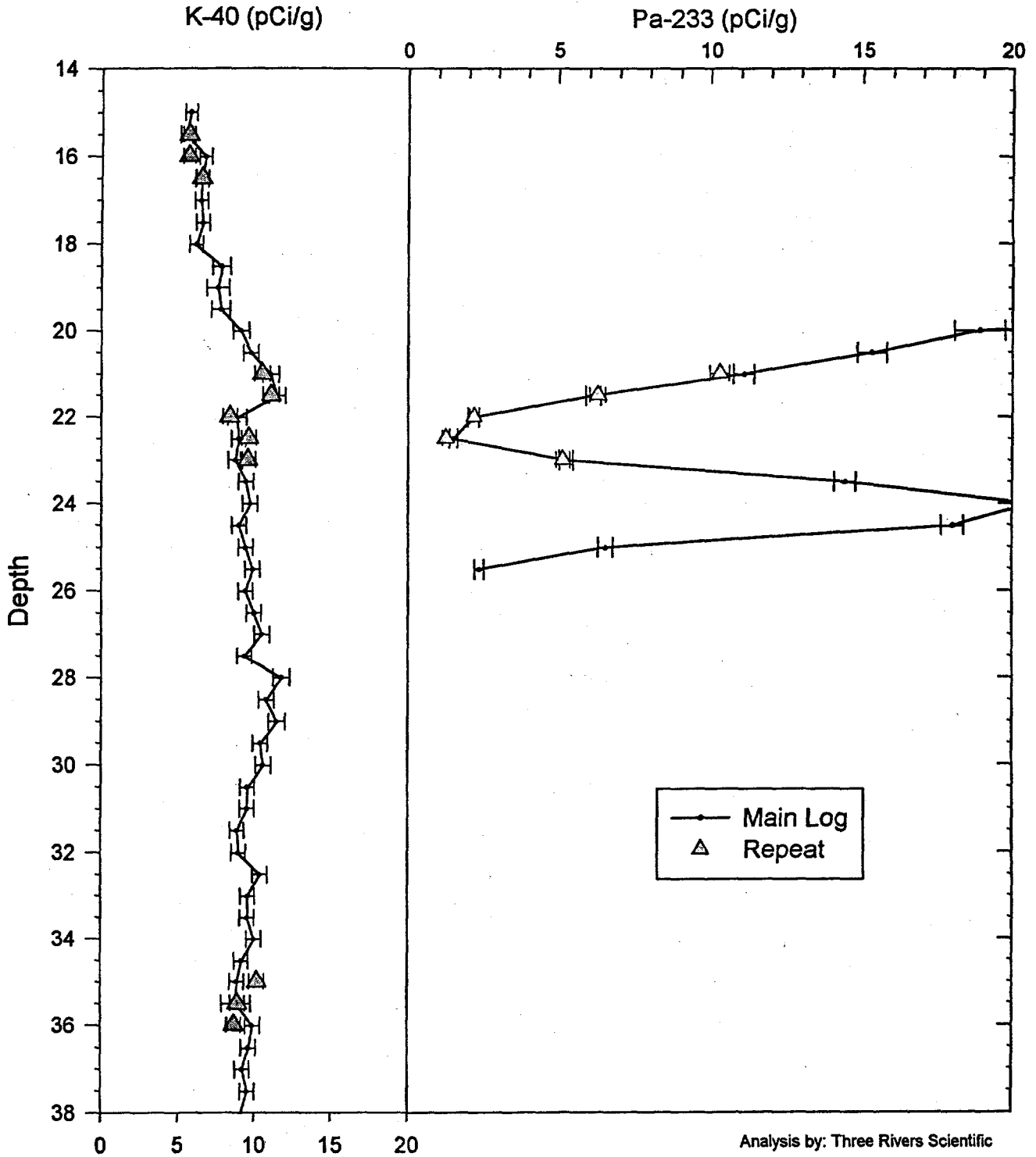


# RLS Spectral Gamma Ray Borehole Survey

## Acceptance QA Processing

Project: Z Crib Geophysics  
Borehole: 299-W18-179

Log Date: Mar. 30, 1998  
Compare Main Log and Repeat



Analysis by: Three Rivers Scientific

# RLS Spectral Gamma Ray Borehole Survey

## Waste Management Federal Services NW

### Log Analysis Summary Report

Project: Z Crib Geophysics  
 Log Type: HPGe Spectral Gamma-Ray

Well ID: 299-W18-179  
 Log Dates: Mar. 30, 1998

**General Notes:**

Total gamma is, in general, a response of formation lithology, except 19 and 24 feet where man-made radionuclides were encountered.

**System Performance Verification:** The pre- and post-log verification was performed using coleman #2 mantle. The maximum FWHM for the 583 keV gamma ray photo peak for the survey date was 2.37 keV. The maximum acceptable FWHM resolution is 3.10 keV for probe RLSG3.1 on the log date.

**Repeat Interval:** The repeat intervals, 15 to 16 feet, 21 to 23 feet, and 35 to 36 feet agrees with the main log within acceptable limits (refer to the Acceptance QA Processing plot).

**Environmental Corrections:** The KUT and man-made radionuclide concentrations have been corrected for casing attenuation over the entire well. No casing correction was applied to the total gamma due to Compton downscatter interference. The thorium increase at 19 and 24 feet is from Tl-208, normally a daughter product of naturally occurring thorium. However, in these zones, dis-equilibrium exist, such that the daughters are elevated, but the parent is not, suggesting waste processing.

**Radionuclides:**

Pa-233 exists from 19.5 to 25.5 feet, with a maximum of 38 pCi/g at 20 feet. The maximum depth for Pa-233 is 25.5 feet at a concentration 5 times above MDL, but the next lower depth sample is absent Pa-233.

Pu-239 exists from 19 to 26 feet, with a maximum of 700 nCi/g at 19 feet. Note that in the upper interval, the MDL is much higher due to the strong Cs-137 interference.

Cs-137 exists from 17 to 21.5 feet, with a maximum of 900 pCi/g at a depth of 19 feet.

Am-241 is observed, but cannot be computed due to strong interference from Cs-137. Am-241 is at too low of a concentration at the depths where Cs-137 is strong.

	Pa-233	Pu-239	Cs-137
<b>max. Concentration</b>	38 pCi/g @ 20 ft	700 nCi/g @ 19 ft	1000 pCi/g @ 19 ft
<b>max. Depth at MDL</b>	25.5 ft	25 ft	22 ft
<b>MDL</b>	0.5 pCi/g	3 nCi/g	0.1 pCi/g

# RLS Spectral Gamma Ray Borehole Survey

## Waste Management Federal Services NW

### Log Header

Project: Z Crib Geophysics

Well: 299-W18-181

Log Type: HPGe Spectral Gamma Ray

#### Borehole Information

Well ID	<u>A7663</u>	Water Depth	<u>None</u>	Total Depth	<u>138</u> ft
Elevation Reference	<u>No Data</u>	Elevation	<u>No Data</u> ft		
Depth Reference	<u>Top of Casing</u>	Casing Stickup	<u>3.04</u> ft		
Casing Diameter	<u>6 in ID</u>	Depth Interval	<u>0 to 138</u> ft	Thickness	<u>0.21</u> in
Casing Diameter	<u>in</u>	Depth Interval	<u>ft</u>	Thickness	<u>in</u>

#### Logging Information

Log Type	HPGe Spectral Gamma Ray	
Company	Waste Management Federal Services NW	
Date/Archive File Name	Mar. 24&28, 1998	H2W18181
Logging Engineers	R. Wilson	
Instrument Series	RLSG3.1	
Logging Unit	RLS2	
Depth Interval	3 to 137 ft	Prefix B181
	31 to 38.5 ft	Prefix B187
Instrument Calibration Date	Sep. 9, 1997	
Calibration Report	WHC-SD-EN-TI-292, Rev. 0	

#### Analysis Information

Company	Three Rivers Scientific
Analyst	Randall Price
Date	April 8, 1998

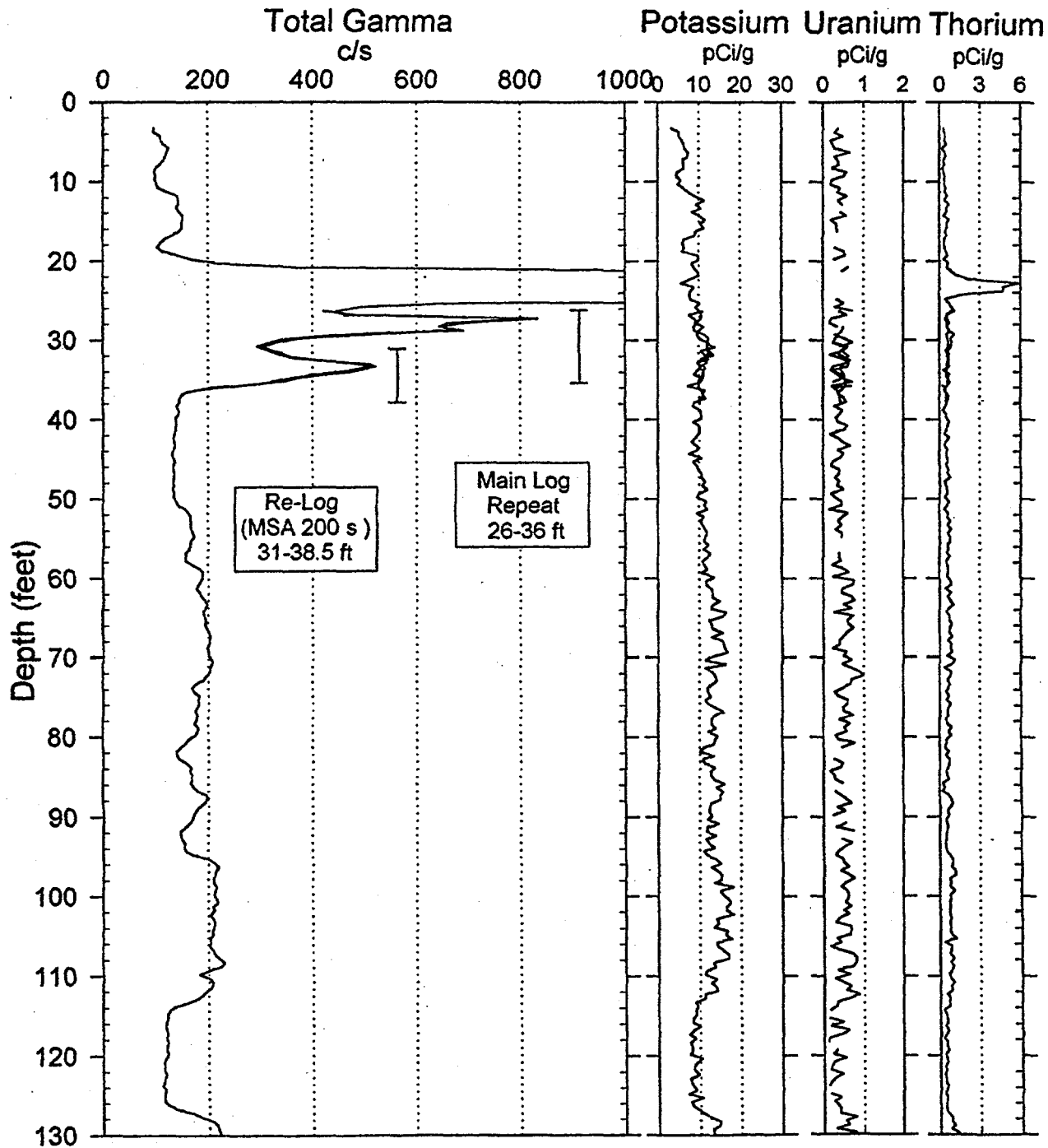
Notes Pa-233 exists from 21.5 to 36 feet, with a maximum of 85 pCi/g at 23 feet. Pu-239 exists from 21.5 to 36.5 feet, with a maximum of 3,000 nCi/g at 23 feet. Am-241 exists from 22 to 35 feet, with a maximum of 470 nCi/g at 23 feet. Cs-137 exists from 19 to 37 feet, with a maximum of 125 pCi/g at 22 feet. The Am-241 is relative and not absolute due to moderate interference from other photo peaks. Pu-240 is also likely, but the severe interference rules out any possibility of quantification. No other man-made radionuclides were detected; however, many other fission and neutron induced gamma rays are present.

# RLS Spectral Gamma Ray Borehole Survey

## Waste Management Federal Services NW

Project: Z Crib Geophysics  
 Borehole: 299-W18-181

Log Date: Mar. 24&28, 1998  
 Naturally Occurring Radionuclides

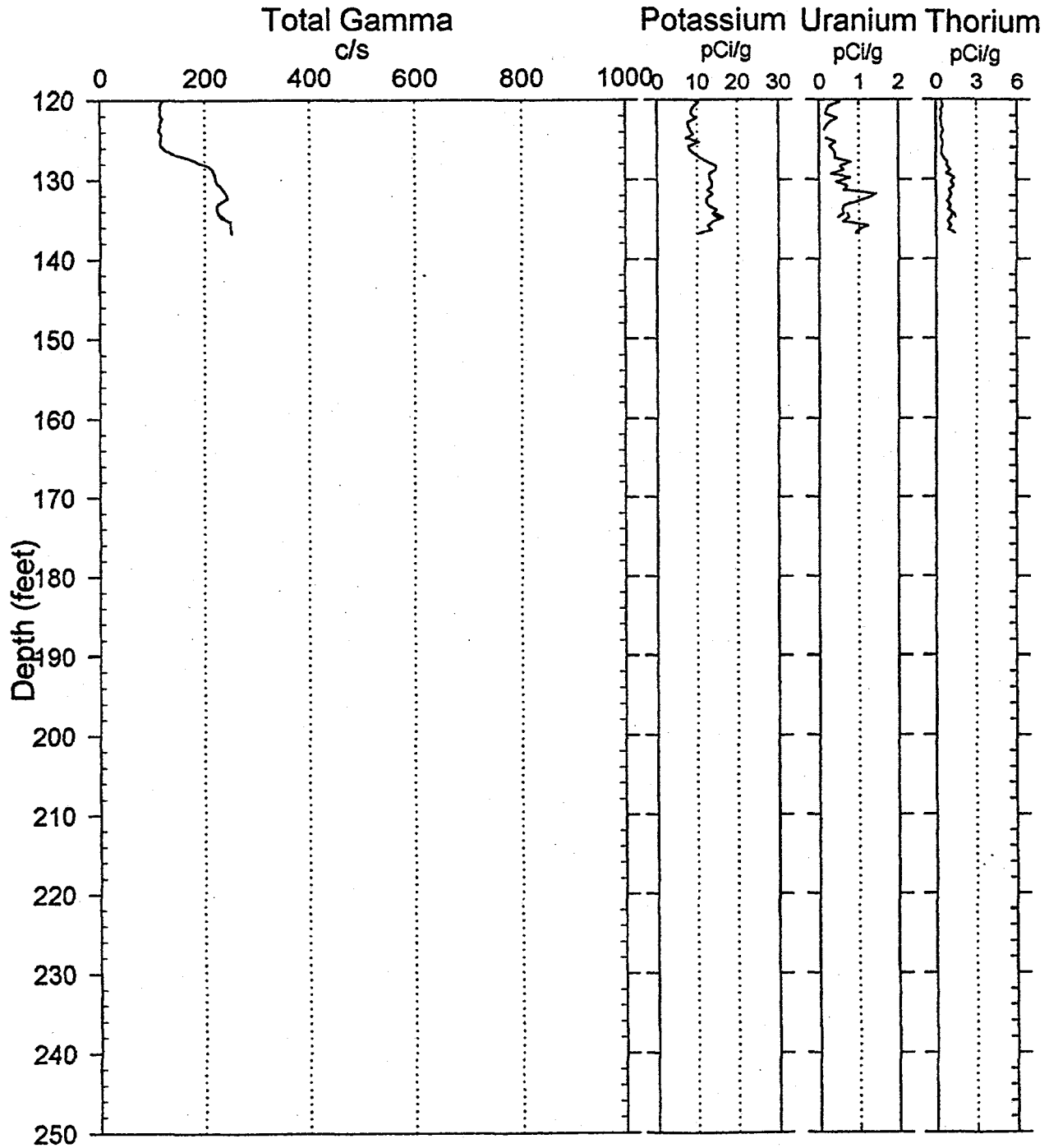


# RLS Spectral Gamma Ray Borehole Survey

## Waste Management Federal Services NW

Project: Z Crib Geophysics  
Borehole: 299-W18-181

Log Date: Mar. 24&28, 1998  
Naturally Occurring Radionuclides



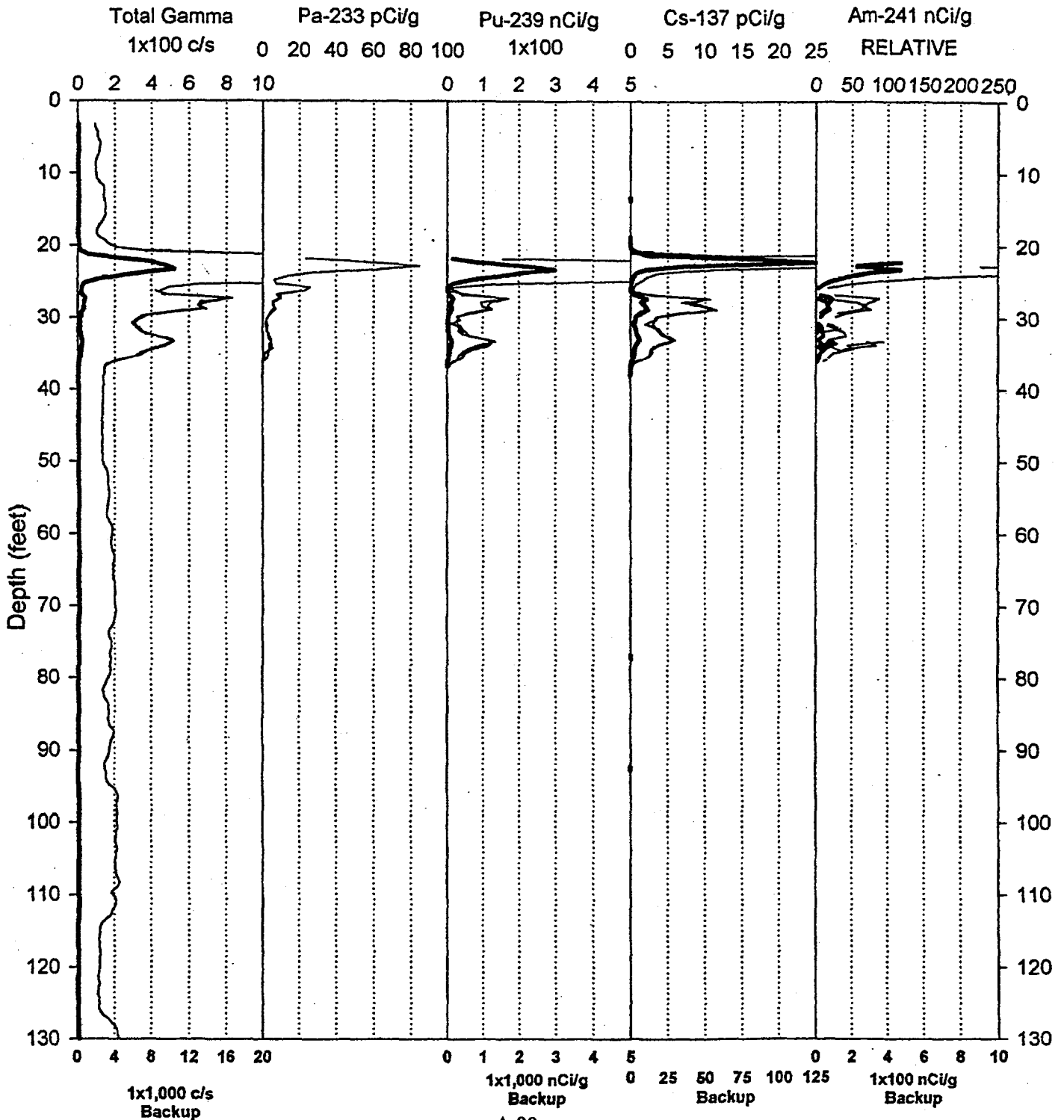
Analysis by: Three Rivers Scientific

# RLS Spectral Gamma Ray Borehole Survey

## Waste Management Federal Services NW

Project: Z Crib Geophysics  
 Borehole: 299-W18-181

Log Date: Mar. 24&28, 1998  
 Man-Made Radionuclides of Concern

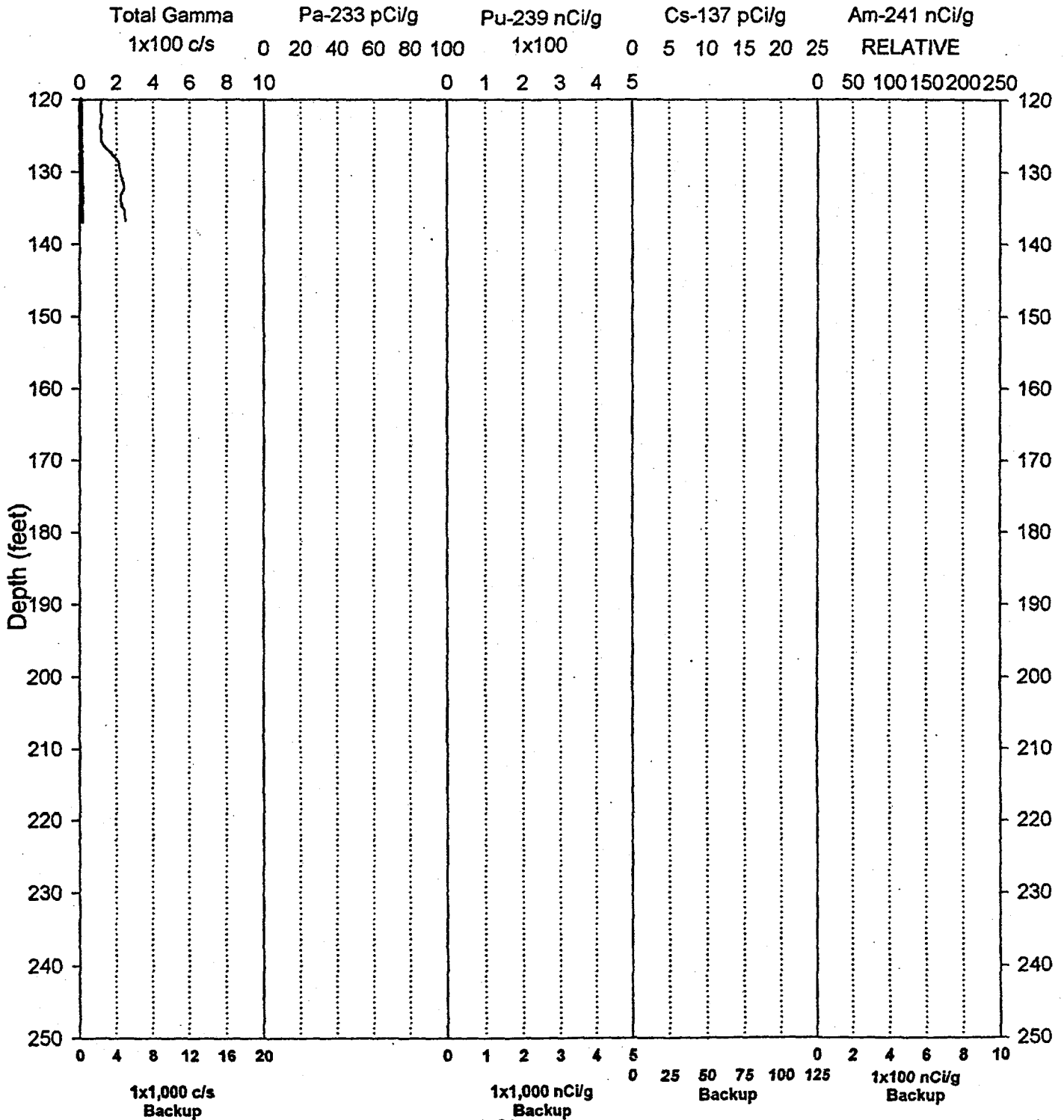


# RLS Spectral Gamma Ray Borehole Survey

Waste Management Federal Services NW

Project: Z Crib Geophysics  
 Borehole: 299-W18-181

Log Date: Mar. 24&28, 1998  
 Man-Made Radionuclides of Concern

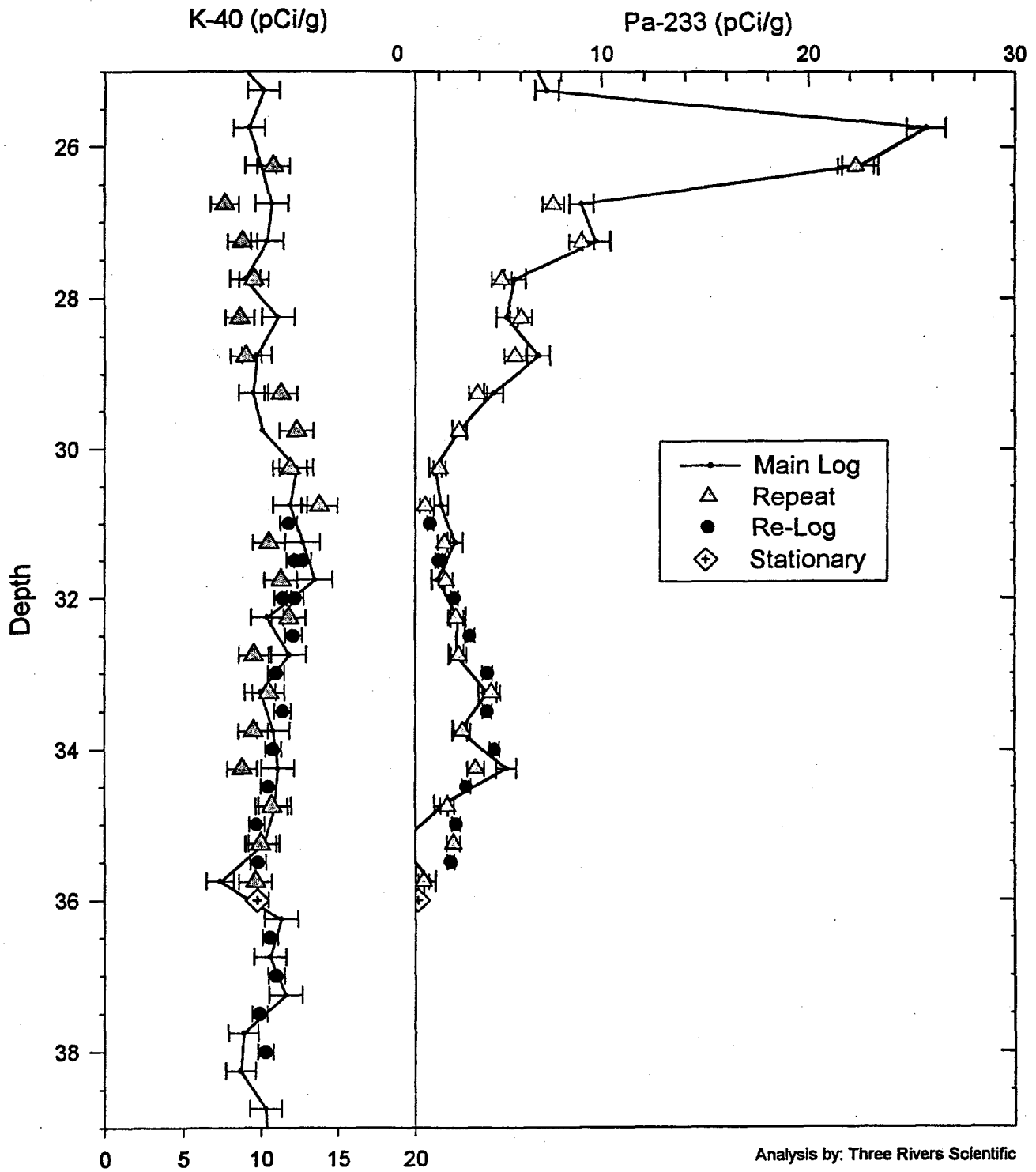


# RLS Spectral Gamma Ray Borehole Survey

## Acceptance QA Processing

Project: Z Crib Geophysics  
Borehole: 299-W18-181

Log Date: Mar. 24 & 28, 1998  
Compare Main Log, Repeat, Re-Log



Analysis by: Three Rivers Scientific

# RLS Spectral Gamma Ray Borehole Survey

Waste Management Federal Services NW

## Log Analysis Summary Report

Project: Z Crib Geophysics  
Log Type: HPGe Spectral Gamma Ray

Well ID: 299-W18-181  
Log Dates: Mar. 24&28, 1998

### General Notes:

Total gamma is a response to man-made gamma ray emitters from 18 to 36 feet, and a function of formation lithology below 36 feet.

**System Performance Verification:** The pre- and post-log verification was performed using coleman #2 mantle. The maximum FWHM for the 583 keV gamma ray photo peak for both survey dates was 2.70 keV. The maximum acceptable FWHM resolution is 3.10 keV for probe RLSG3.1 on the log dates.

**Repeat Interval:** The repeat interval, 26 to 36 feet, agrees with the main log within acceptable limits (refer to the Acceptance QA Processing plot).

**Environmental Corrections:** The KUT and man-made radionuclide concentrations have been corrected for casing attenuation over the entire well. No casing correction was applied to the total gamma due to Compton downscatter interference. The thorium from 21 to 25 feet is from Tl-208, normally a daughter product of naturally occurring thorium; however, the secular equilibrium is greatly disturbed, indicating that the thorium is not solely due to natural lithology, and may be a waste by-product.

### Radionuclides:

Pa-233 exists from 21.5 to 36 feet, with a maximum of 85 pCi/g at 23 feet. Pu-239 exists from 21.5 to 36.5 feet, with a maximum of 3,000 nCi/g at 23 feet. Am-241 exists from 22 to 35 feet, with a maximum of 470 nCi/g at 23 feet. Cs-137 exists from 19 to 37 feet, with a maximum of 125 pCi/g at 22 feet. The Am-241 is relative and not absolute due to moderate interference from other photo peaks. Pu-240 is also likely, but the severe interference rules out any possibility of quantification. No other man-made radionuclides were detected; however, many other fission and neutron induced gamma rays are present.

The high degree of variance of Am-241 over the interval 22 to 35 feet is real and not an artifact of the processing, even though the processing is adversely affected by other photo peak interference.

	Pa-233	Pu-239	Cs-137	Am-241
max. Concentration	85 pCi/g @ 23 ft	3,000 nCi/g @ 23 ft	125 pCi/g @ 22 ft	470 nCi/g @ 23 ft
max. Depth at MDL	35.5 ft	36 ft	37 ft	35 ft
MDL	2 pCi/g	10 nCi/g	0.25 pCi/g	30 nCi/g

# RLS Spectral Gamma Ray Borehole Survey

## Waste Management Federal Services NW

### Log Header

Project: Z Crib Geophysics

Well: 299-W18-182

Log Type: HPGe Spectral Gamma Ray

#### Borehole Information

Well ID	A7664	Water Depth	None	Total Depth	40	ft
Elevation Reference	No Data	Elevation	No Data			
Depth Reference	Top of Casing	Casing Stickup	2.35			ft
Casing Diameter	6 in ID	Depth Interval	0 to 40	Thickness	0.21	in
Casing Diameter	in	Depth Interval		Thickness		in

#### Logging Information

Log Type	HPGe Spectral Gamma Ray	
Company	Waste Management Federal Services NW	
Date/Archive File Name	Mar. 31, 1998 H2W18182	
Logging Engineers	R. Wilson	
Instrument Series	RLSG3.1	
Logging Unit	RLS2	
Depth Interval	0 to 39.5 ft	Prefix B190
Instrument Calibration Date	Sep. 9, 1997	
Calibration Report	WHC-SD-EN-TI-292, Rev. 0	

#### Analysis Information

Company	Three Rivers Scientific	
Analyst	Randall Price	
Date	April 8, 1998	

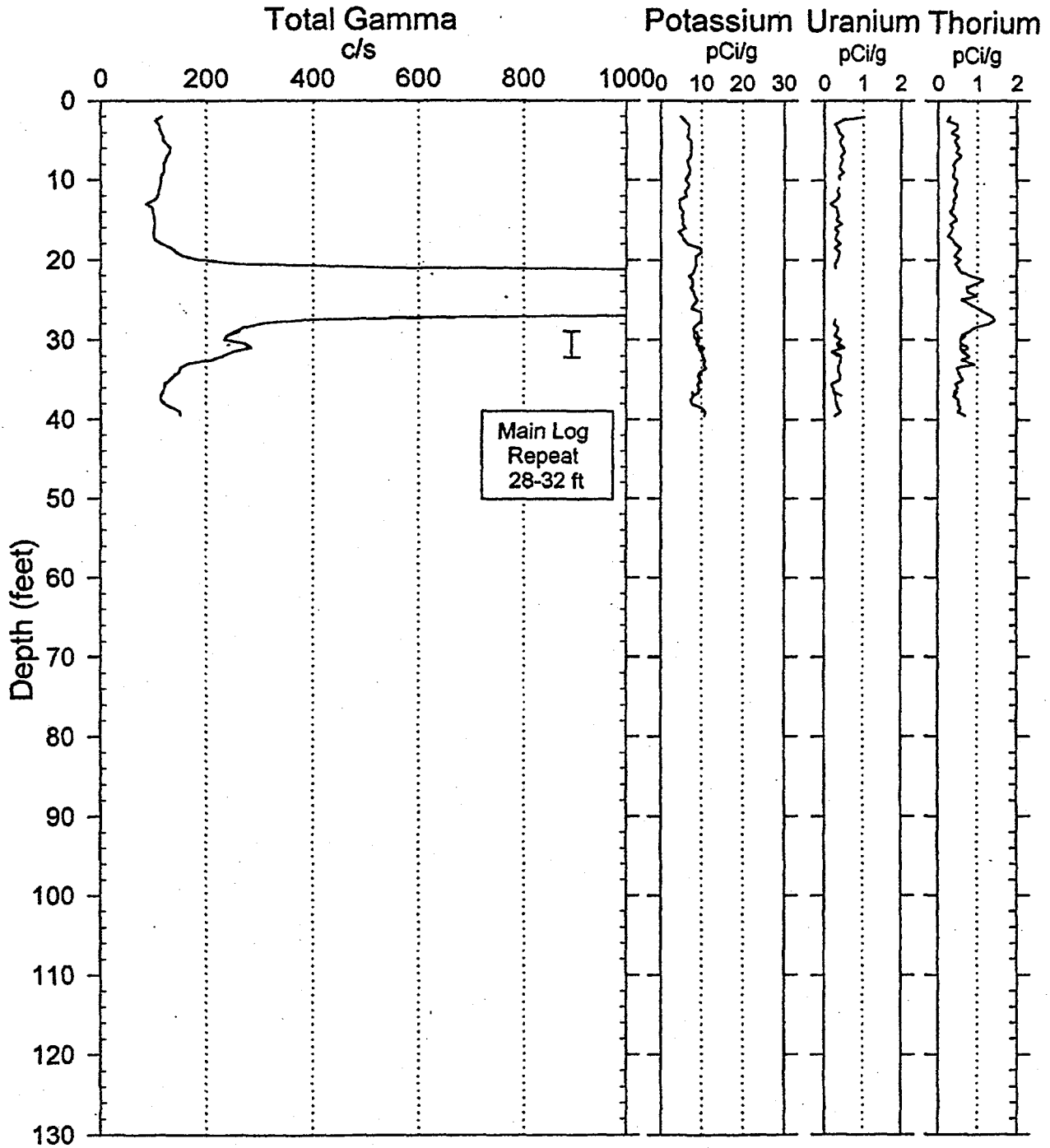
Notes Pa-233 exists from 21.5 to 33 feet, with a maximum of 30 pCi/g at 22.5 feet. Pu-239 exists from 21 to 32 feet, with a maximum of 1,100 nCi/g at 22.5 feet. Am-241 exists from 21.5 to 25 feet, with a maximum of 2,100 nCi/g at 23 feet. Cs-137 exists from 18.5 to 29.5 feet, with a maximum of 250 pCi/g at 26 feet. The Am-241 is relative due to moderate photo peak interference. Pu-240 is also likely, but the severe interference rules out any possibility of quantification. No other man-made radionuclides were detected; however, many other fission and neutron induced gamma rays are present.

# RLS Spectral Gamma Ray Borehole Survey

## Waste Management Federal Services NW

Project: Z Crib Geophysics  
Borehole: 299-W18-182

Log Date: Mar. 31, 1998  
Naturally Occurring Radionuclides



# RLS Spectral Gamma Ray Borehole Survey

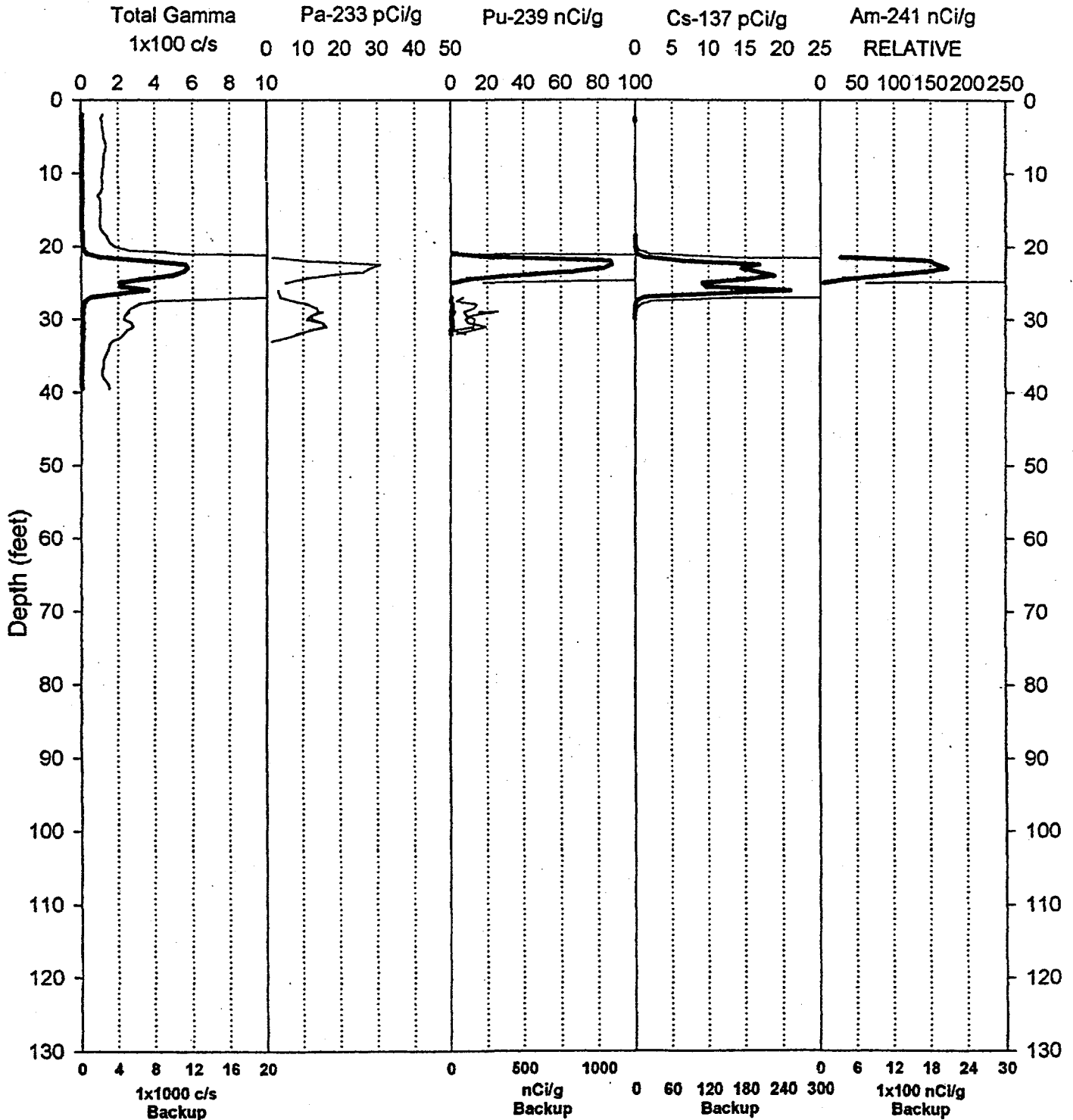
Waste Management Federal Services NW

Project: Z Crib Geophysics

Log Date: Mar. 31, 1998

Borehole: 299-W18-182

Man-Made Radionuclides of Concern

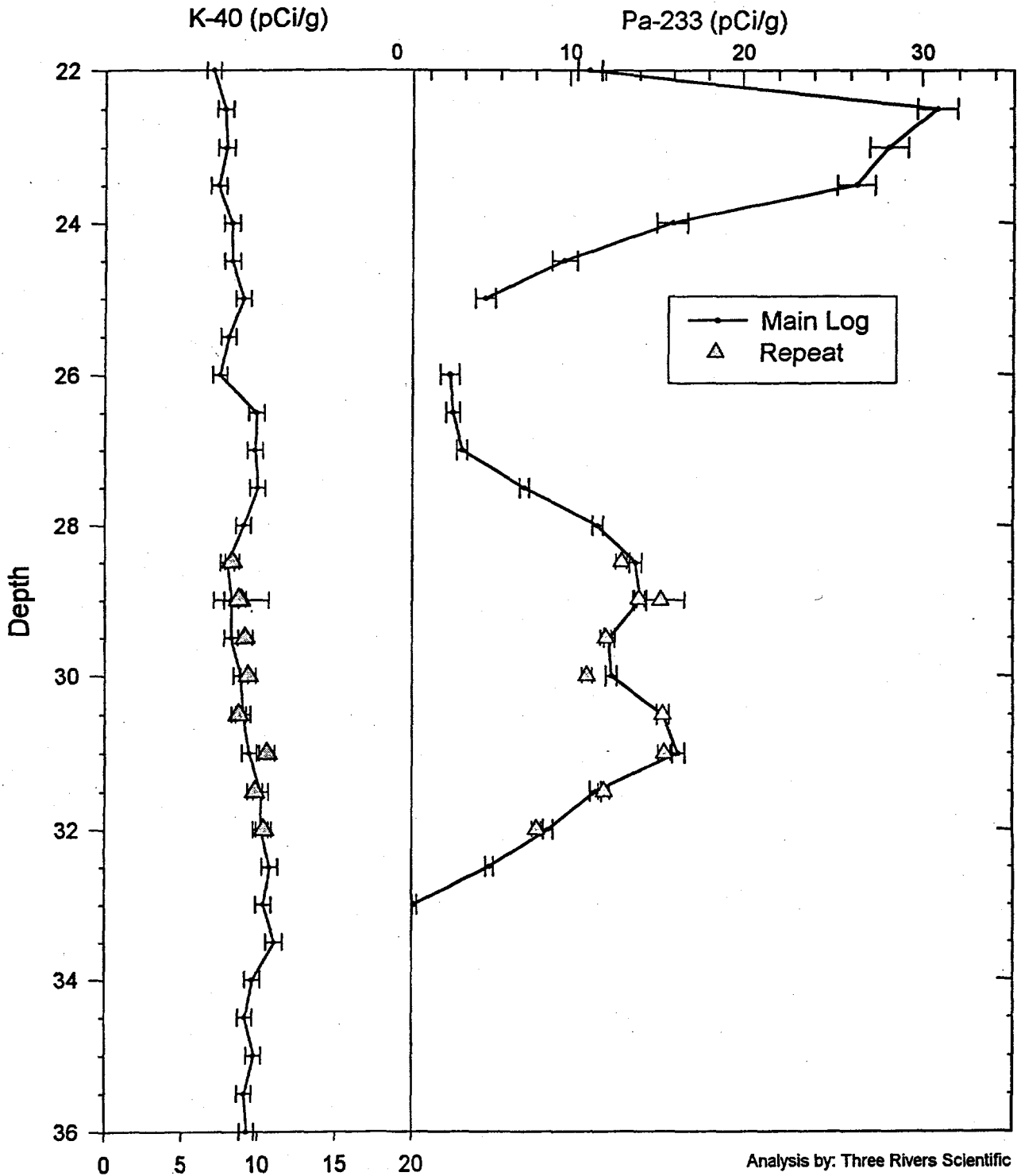


# RLS Spectral Gamma Ray Borehole Survey

## Acceptance QA Processing

Project: Z Crib Geophysics  
Borehole: 299-W18-182

Log Date: Mar. 31, 1998  
Compare Main Log, Repeat



# RLS Spectral Gamma Ray Borehole Survey

Waste Management Federal Services NW

## Log Analysis Summary Report

Project: Z Crib Geophysics  
Log Type: HPGe Spectral Gamma Ray

Well ID: 299-W18-182  
Log Dates: Mar. 31, 1998

### General Notes:

Total gamma is a response to man-made gamma ray emitters from 18 to 35 feet.

**System Performance Verification:** The pre- and post-log verification was performed using coleman #2 mantle. The maximum FWHM for the 583 keV gamma ray photo peak was 2.71 keV. The maximum acceptable FWHM resolution is 3.10 keV for probe RLSG3.1 on the log date.

**Repeat Interval:** The repeat interval, 28 to 32 feet, agrees with the main log within acceptable limits (refer to the Acceptance QA Processing plot).

**Environmental Corrections:** The KUT and man-made radionuclide concentrations have been corrected for casing attenuation over the entire well. No casing correction was applied to the total gamma due to Compton downscatter interference. The thorium from 18 to 33 feet is from Th-232, normally a daughter product of naturally occurring uranium; however, the secular equilibrium is disturbed, indicating that the thorium is not solely due to natural lithology and may be a waste by-product.

### Radionuclides:

Pa-233 exists from 21.5 to 33 feet, with a maximum of 30 pCi/g at 22.5 feet. Pu-239 exists from 21 to 32 feet, with a maximum of 1,100 nCi/g at 22.5 feet. Am-241 exists from 21.5 to 25 feet, with a maximum of 2,100 nCi/g at 23 feet. Cs-137 exists from 18.5 to 29.5 feet, with a maximum of 250 pCi/g at 26 feet. The Am-241 is relative and not absolute due to moderate interference from other photo peaks. Pu-240 is also likely, but the severe interference from other photo peaks rules out any possibility of quantification. No other man-made radionuclides were detected; however, many other fission and neutron induced gamma rays are present.

	Pa-233	Pu-239	Cs-137	Am-241
max. Concentration	30 pCi/g @22.5 ft	1,100 nCi/g @ 22.5 ft	250 pCi/g @ 26 ft	2,100 nCi/g @ 23 ft
max. Depth at MDL	33 ft	32 ft	29 ft	25 ft
MDL	1 pCi/g	5 nCi/g	0.1 pCi/g	60 nCi/g

# RLS Spectral Gamma Ray Borehole Survey

## Waste Management Federal Services NW

### Log Header

Project: Z Crib Geophysics

Well: 299-W18-183

Log Type: HPGe Spectral Gamma Ray

#### Borehole Information

Well ID	<u>A7665</u>	Water Depth	<u>None</u>	Total Depth	<u>38</u>	ft
Elevation Reference	<u>No Data</u>	Elevation	<u>No Data</u>			
Depth Reference	<u>Top of Casing</u>	Casing Stickup	<u>1.87</u>			
Casing Diameter	<u>6</u> in ID	Depth Interval	<u>0 to 38</u>	Thickness	<u>0.18</u>	in
Casing Diameter	<u>   </u> in	Depth Interval	<u>          </u>	Thickness	<u>      </u>	in

#### Logging Information

Log Type	HPGe Spectral Gamma Ray	
Company	Waste Management Federal Services NW	
Date/Archive File Name	Apr. 1, 1998	H2W18183
Logging Engineers	R. Wilson	
Instrument Series	RLSG3.1	
Logging Unit	RLS2	
Depth Interval	2 to 37.5 ft	Prefix B192
Instrument Calibration Date	Sep. 9, 1997	
Calibration Report	WHC-SD-EN-TI-292, Rev. 0	

#### Analysis Information

Company	Three Rivers Scientific
Analyst	Randall Price
Date	April 8, 1998

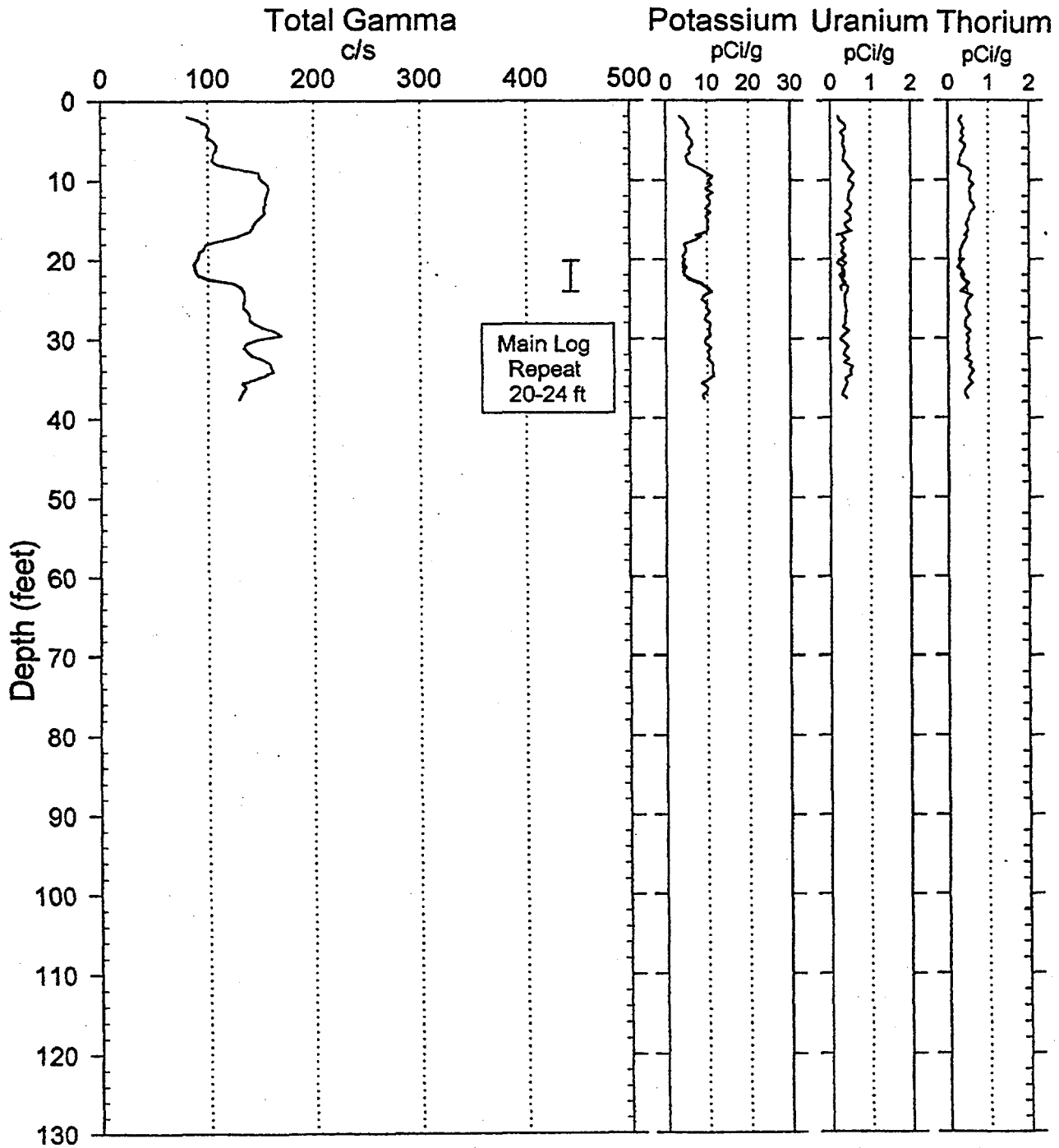
Notes Pa-233 exists from 26 to 30 feet, with a maximum of 2 pCi/g at 29.5 feet. Cs-137 exists in two zones: 2 to 3.5 and 8 to 11.5 feet, with concentrations less than 1 pCi/g.

# RLS Spectral Gamma Ray Borehole Survey

## Waste Management Federal Services NW

Project: Z Crib Geophysics  
Borehole: 299-W18-183

Log Date: Apr. 1, 1998  
Naturally Occurring Radionuclides

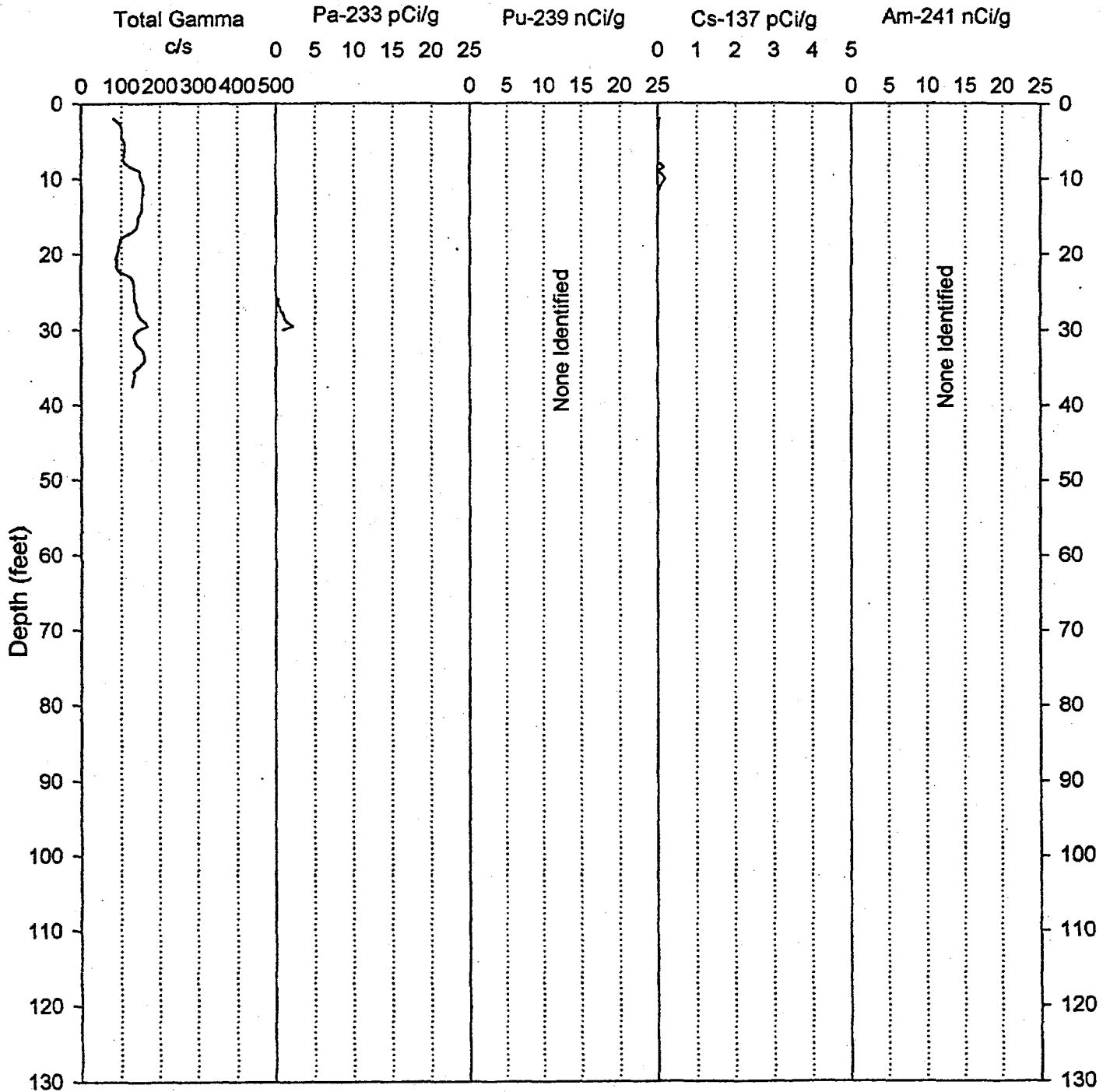


# RLS Spectral Gamma Ray Borehole Survey

## Waste Management Federal Services NW

Project: Z Crib Geophysics  
 Borehole: 299-W18-183

Log Date: Apr. 1, 1998  
 Man-Made Radionuclides of Concern



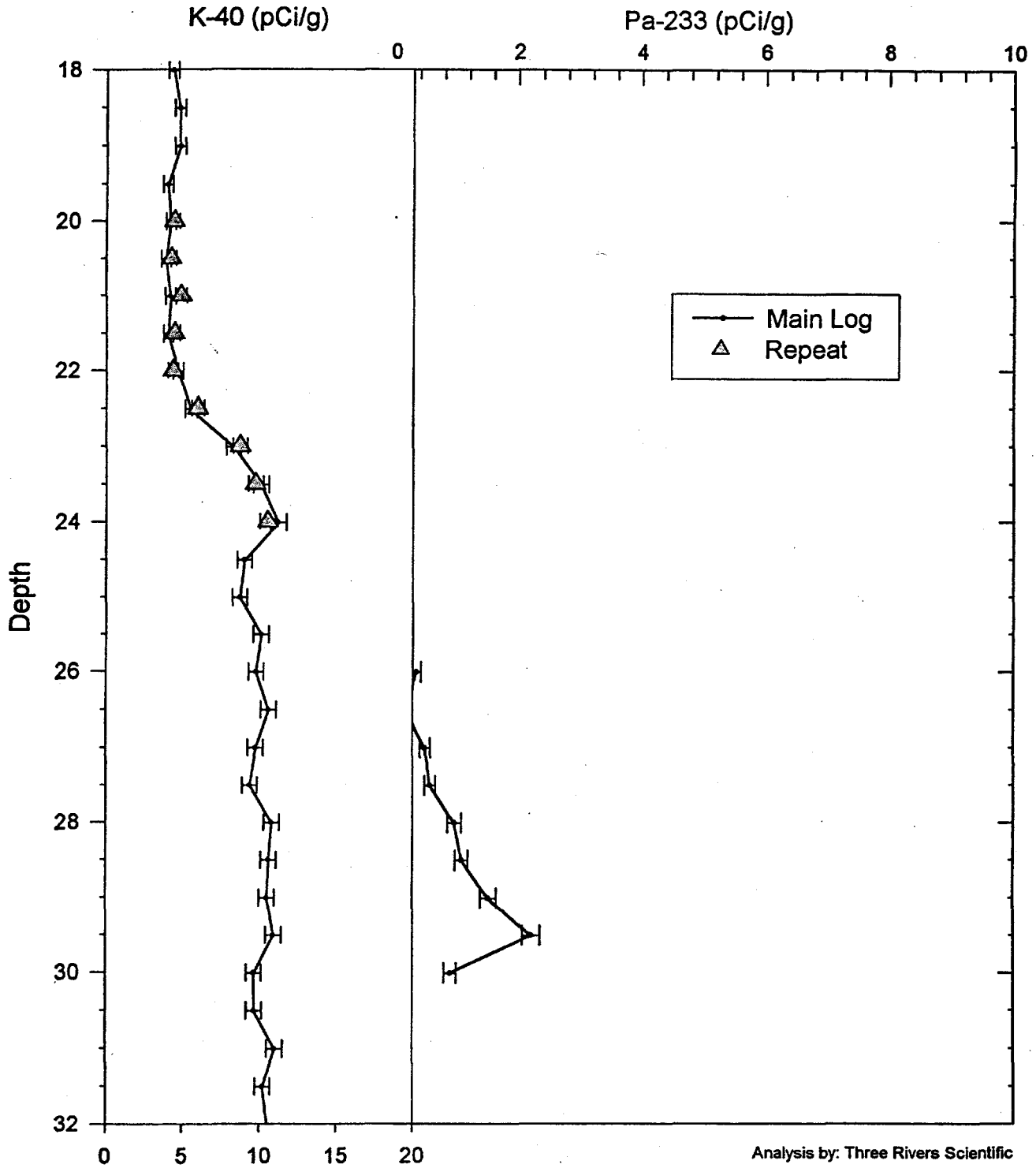
Analysis by: Three Rivers Scientific

# RLS Spectral Gamma Ray Borehole Survey

## Acceptance QA Processing

Project: Z Crib Geophysics  
Borehole: 299-W18-183

Log Date: Apr. 1, 1998  
Compare Main Log, Repeat



**RLS Spectral Gamma Ray Borehole Survey**  
Waste Management Federal Services NW

**Log Analysis Summary Report**

Project: Z Crib Geophysics  
Log Type: HPGe Spectral Gamma Ray

Well ID: 299-W18-183  
Log Dates: Apr. 1, 1998

**General Notes:**

Total gamma is a function of formation lithology except for the low level radioactive zone from 26 to 30 feet.

**System Performance Verification:** The pre- and post-log verification was performed using coleman #2 mantle. The maximum FWHM for the 583 keV gamma ray photo peak was 2.49 keV. The maximum acceptable FWHM resolution is 3.10 keV for probe RLSG3.1 on the log date.

**Repeat Interval:** The repeat interval, 20 to 24 feet, agrees with the main log within acceptable limits (refer to the Acceptance QA Processing plot).

**Environmental Corrections:** The KUT and man-made radionuclide concentrations have been corrected for casing attenuation over the entire well. No casing correction was applied to the total gamma due to Compton downscatter interference.

**Radionuclides:**

Pa-233 exists from 26 to 30 feet, with a maximum of 2 pCi/g at 29.5 feet. Cs-137 exists in two zones: 2-3.5 and 8-11.5 feet, with concentrations less than 1 pCi/g.

	<b>Pa-233</b>	<b>Cs-137</b>
<b>max. Concentration</b>	2 pCi/g @ 29.5 ft	<1 pCi/g @ 10 ft
<b>max. Depth at MDL</b>	30 ft	11 ft
<b>MDL</b>	0.2 pCi/g	0.1 pCi/g

# RLS Spectral Gamma Ray Borehole Survey

## Waste Management Federal Services NW

### Log Header

Project: Z Crib Geophysics

Well: 299-W18-185

Log Type: HPGe Spectral Gamma-Ray

#### Borehole Information

Well ID	<u>A7667</u>	Water Depth	<u>none</u>	Total Depth	<u>39.1</u> ft
Elevation Reference	<u>No Data</u>	Elevation	<u>No Data</u> ft		
Depth Reference	<u>Top of Casing</u>	Casing Stickup	<u>2.67</u> ft		
Casing Diameter	<u>6</u> in ID	Depth Interval	<u>0 to 39.1</u> ft	Thickness	<u>0.19</u> in
Casing Diameter	<u>  </u> in	Depth Interval	<u>      </u> ft	Thickness	<u>      </u> in

#### Logging Information

Log Type	HPGe Spectral Gamma Ray	
Company	Waste Management Federal Services NW	
Date/Archive File Name	Apr. 2, 1998	H2W18185
Logging Engineers	R. Wilson	
Instrument Series	RLSG3.1	
Logging Unit	RLS2	
Depth Interval	0 to 38.5 ft	Prefix B193
Instrument Calibration Date	Sep. 9, 1997	
Calibration Report	WHC-SD-EN-TI-292, Rev. 0	

#### Analysis Information

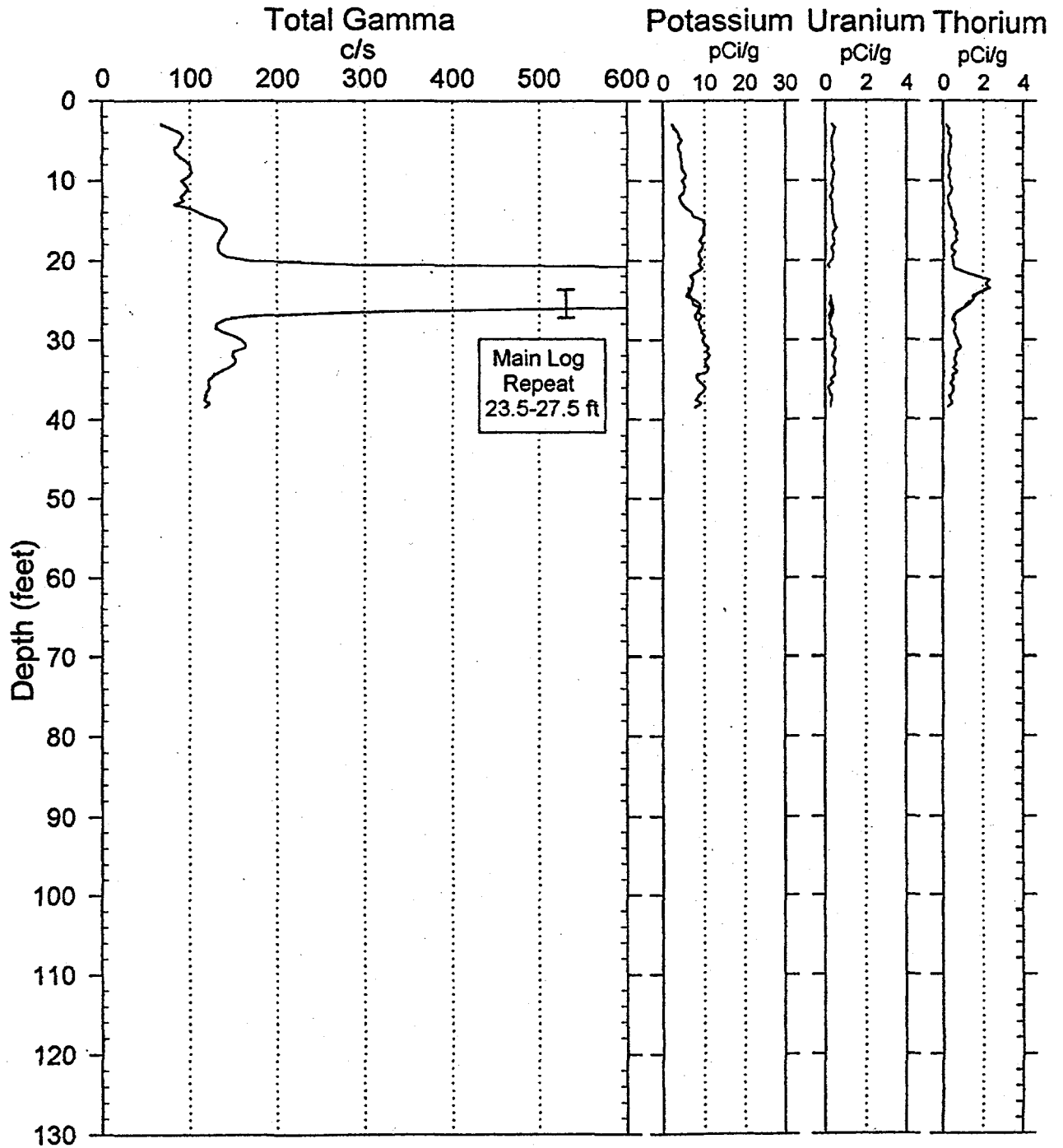
Company	Three Rivers Scientific
Analyst	Russ Randall
Date	March 21, 1998
Notes	<u>Cs-137, Pa-233, Am-241, and Pu-239 were identified. Cs-137 exists from 20 to 26 feet, with a maximum of 216 pCi/g at 22 feet. Pa-137 exists from 21 to 28.5 feet, with a maximum of 61 pCi/g at 22 feet. Am-241 exists from 21.5 to 25 feet, with a maximum of 386 nCi/g at 24 feet. Pu-239 exists from 21 to 26.5 feet, with a maximum of 1,047 nCi/g at 22.5 feet.</u>

# RLS Spectral Gamma Ray Borehole Survey

## Waste Management Federal Services NW

Project: Z Crib Geophysics  
Borehole: 299-W18-185

Log Date: Apr. 2, 1998  
Naturally Occurring Radionuclides

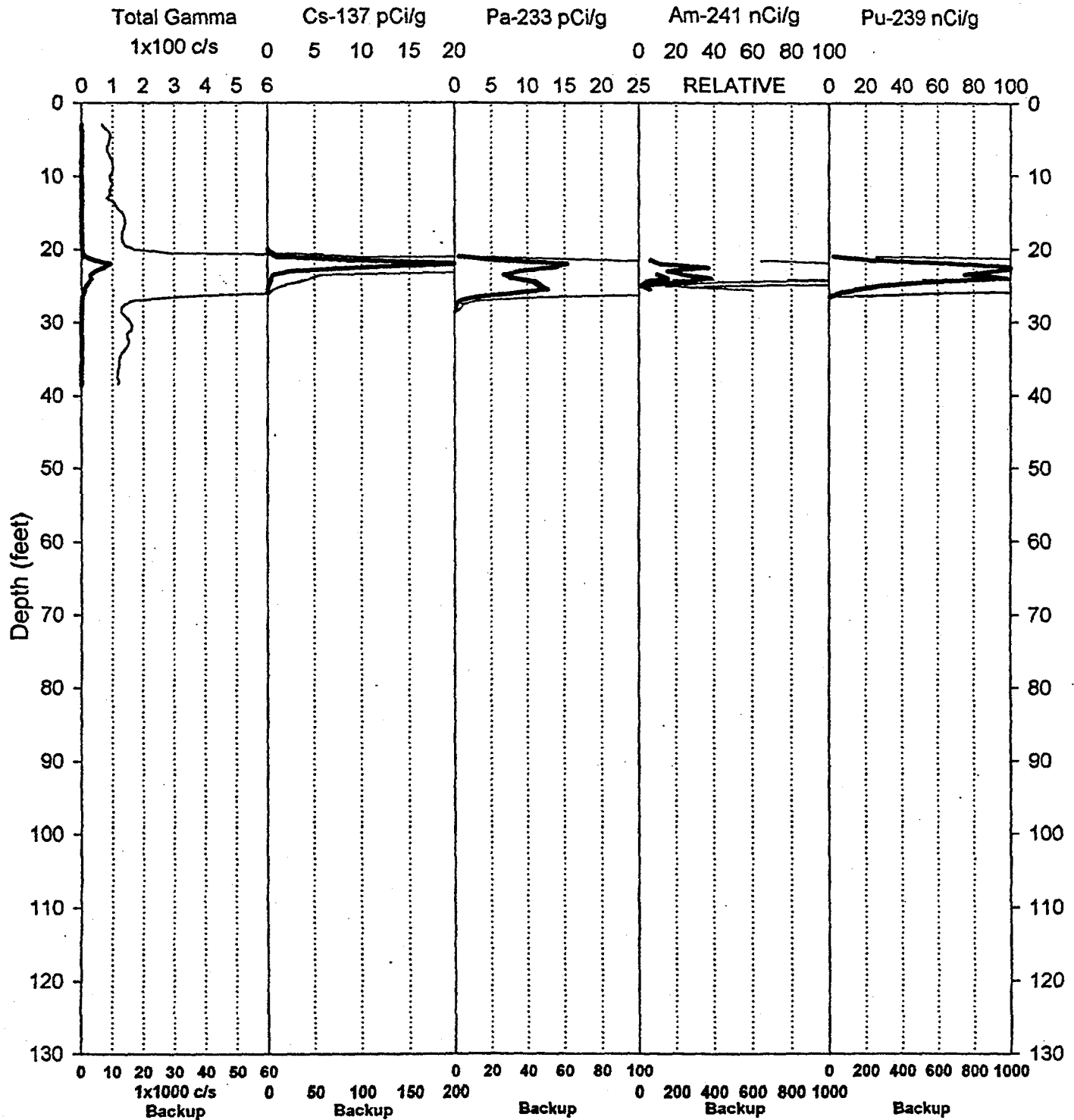


# RLS Spectral Gamma Ray Borehole Survey

## Waste Management Federal Services NW

Project: Z Crib Geophysics  
 Borehole: 299-W18-185

Log Date: Apr. 2, 1998  
 Man-Made Radionuclides of Concern



A.104

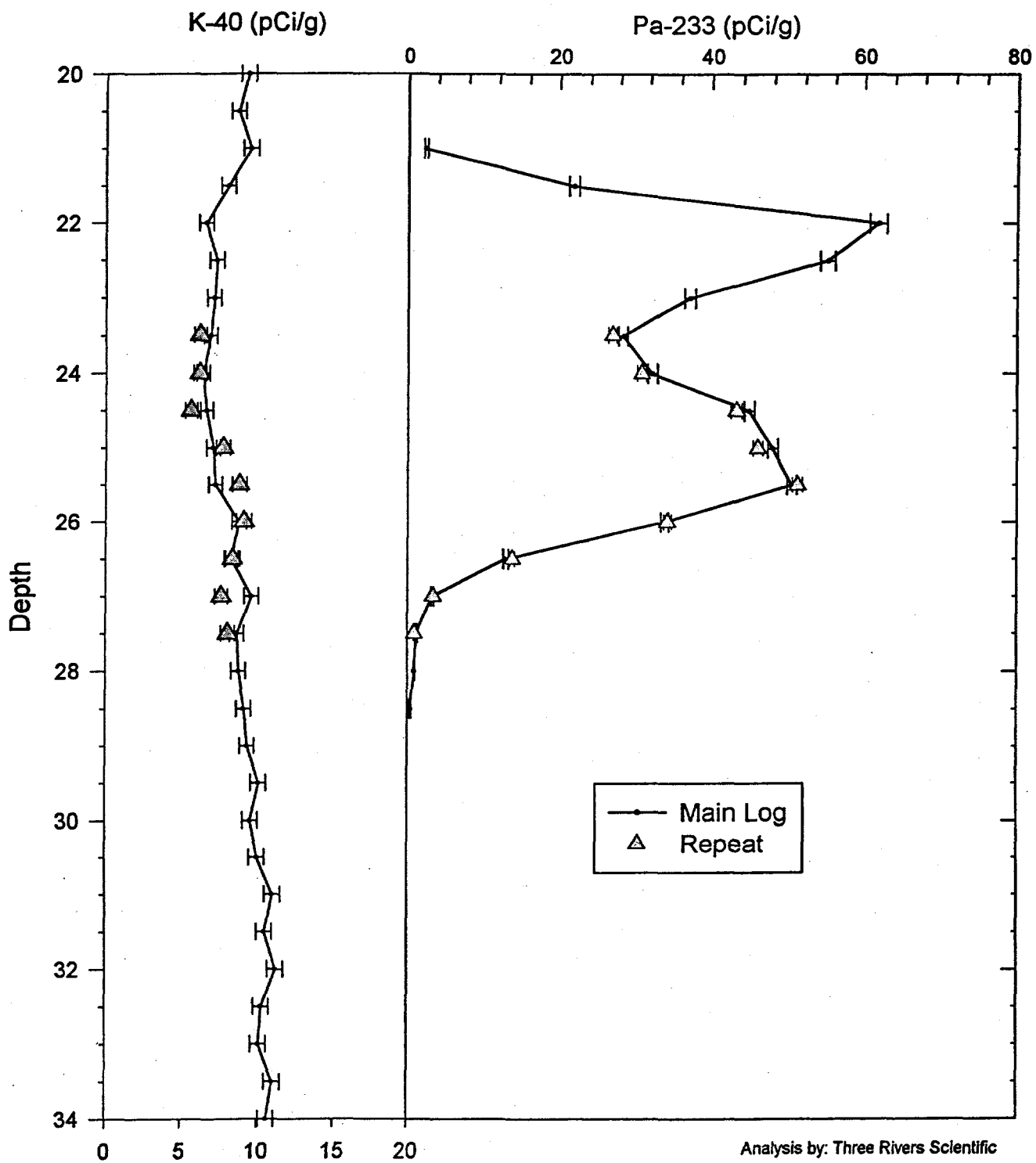
Analysis by: Three Rivers Scientific

# RLS Spectral Gamma Ray Borehole Survey

## Acceptance QA Processing

Project: Z Crib Geophysics  
Borehole: 299-W18-185

Log Date: Apr. 2, 1998  
Compare Main Log and Repeat



# RLS Spectral Gamma Ray Borehole Survey

## Waste Management Federal Services NW

### Log Analysis Summary Report

Project: Z Crib Geophysics  
 Log Type: HPGe Spectral Gamma-Ray

Well ID: 299-W18-185  
 Log Dates: Apr. 2, 1998

**General Notes:**

Total gamma is, in general, a response of formation lithology, except from 20 to 28.5 feet where man-made radionuclides were encountered.

**System Performance Verification:** The pre- and post-log verification was performed using coleman #2 mantle. The maximum FWHM for the 583 keV gamma ray photo peak for the survey date was 2.52 keV. The maximum acceptable FWHM resolution is 3.10 keV for probe RLSG3.1 on the log dates.

**Repeat Interval:** The repeat interval, 23.5 to 27.5 feet, agrees with the main log within acceptable limits (refer to the Acceptance QA Processing plot).

**Environmental Corrections:** The KUT and man-made radionuclide concentrations have been corrected for casing attenuation over the entire well. No casing correction was applied to the total gamma due to Compton downscatter interference. The thorium increase at 23 feet is from Tl-208, normally a daughter product of naturally occurring thorium; however, the increase is not solely due to natural lithology and may be a waste by-product. Uranium is not observed from 21 to 25 feet as a result of the increased MDL for uranium due to the interference from the other gamma rays present.

**Radionuclides:**

Cs-137 exists from 20 to 26 feet, with a maximum reading of 216 pCi/g at 22 feet. The maximum depth for Cs-137 is 26 feet at a concentration twice MDL, but the next lower depth sample is absent Cs-137.

Pa-233 is observed from 21 to 28.5 feet, with a maximum reading of 61 pCi/g at 22 feet. The maximum depth for Pa-233 is 28.5 feet at a concentration higher than MDL, but the next lower depth sample is absent Pa-233.

Am-241 is observed from 21.5 to 25 feet, with a maximum reading of 386 nCi/g at 24 feet. The maximum depth for Am-241 is 25 feet at a concentration twice MDL, but the next lower depth sample is absent Am-241. Photo peak interference does exist to a moderate degree for Am-241, therefore, the plot scale is labeled relative.

Pu-239 is observed from 21 to 26.5 feet, with a maximum reading of 1,047 nCi/g at 22.5 feet. The maximum depth for Pu-239 is 26.5 feet at a concentration higher than MDL, but the next lower depth sample is absent Pu-239.

	Cs-137	Pa-233	Am-241	Pu-239
max. Concentration	216 pCi/g @ 22 ft	61 pCi/g @ 22 ft	386 nCi/g @ 24 ft	1,047 nCi/g @ 22.5 ft
max. Depth at or above MDL	22 ft	28.5	25 ft	26.5 ft
MDL	0.05 pCi/g	.4 pCi/g	40 nCi/g	8 nCi/g