



U.S. Department of Energy

HOISTING AND RIGGING MANUAL

DRAFT

RECEIVED
OCT 01 1996
OSTI

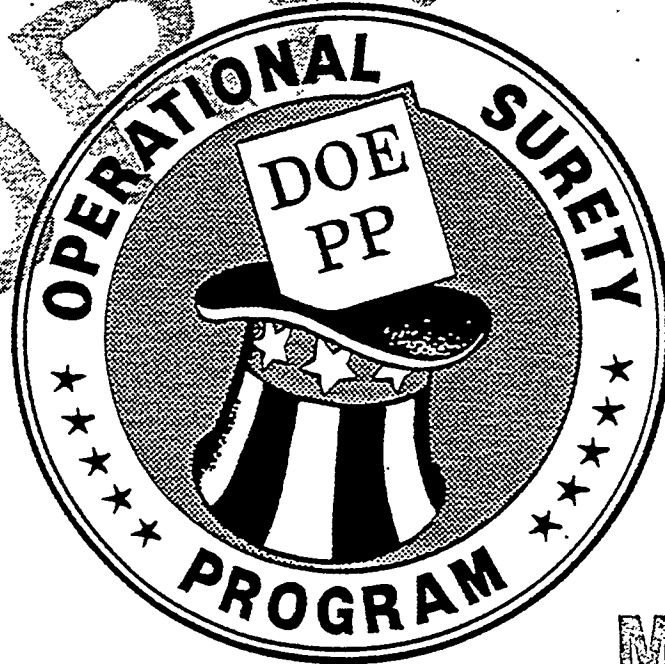

MASTER

May, 1991

UNCONTROLLED DOCUMENT

Distributed by:

Operation Programs

DISTRIBUTION OF THIS DOCUMENT IS UNLIMITED

7717

Y9(2) Y9(2)

NOTICE

This document is NOT maintained by the GEND document control system. For information regarding the latest issue of this document contact Shirley Taylor, Operation Programs, MS 009, X8546.

173

DEPARTMENT OF ENERGY HOISTING & RIGGING MANUAL	TITLE: TERMINOLOGY AND DEFINITIONS NUMBER: 1.0 REV: 00/91
---	--

CONTENTS

Definitions	1-1
-------------------	-----

FIGURES

1-1 Choker rope	1-13
1-2 Hoist	1-13
1-3 Rope Lay	1-13
1-4 Shackle	1-14
1-5 Slings	1-14
1-6 Thimble	1-14
1-7 Types of Trucks	1-15
1-7 Types of Trucks (continued)	1-17
1-7 Types of Trucks (continued)	1-18

DISCLAIMER

This report was prepared as an account of work sponsored by an agency of the United States Government. Neither the United States Government nor any agency thereof, nor any of their employees, makes any warranty, express or implied, or assumes any legal liability or responsibility for the accuracy, completeness, or usefulness of any information, apparatus, product, or process disclosed, or represents that its use would not infringe privately owned rights. Reference herein to any specific commercial product, process, or service by trade name, trademark, manufacturer, or otherwise does not necessarily constitute or imply its endorsement, recommendation, or favoring by the United States Government or any agency thereof. The views and opinions of authors expressed herein do not necessarily state or reflect those of the United States Government or any agency thereof.

DISCLAIMER

Portions of this document may be illegible in electronic image products. Images are produced from the best available original document.

DEPARTMENT OF ENERGY HOISTING & RIGGING MANUAL	TITLE: TERMINOLOGY AND DEFINITIONS NUMBER: 1.0 REV: 00/91
---	--

ISSUE NO.

1.0 TERMINOLOGY AND DEFINITIONS

The following are specialized terms usually used when discussing hoisting and rigging operations. Many terms are included for general information but not all are used in this Manual. The terms are arranged in alphabetical order. Illustrations are included for clarity.

ABRASION: Surface wear.

ACCELERATION STRESS: Additional stress imposed due to changing velocity of load.

ALTERNATE LAY: Lay of wire rope in which the strands are alternately regular and Lang Lay.

ANSI: American National Standards Institute.

APPOINTED: Assigned specific responsibilities by the employer or the employer's representative.

AREA, METALLIC: Sum of the cross-sectional areas of individual wires in a wire rope or strand.

ATTACHMENT: A device other than conventional forks or load backrest extension, mounted permanently or removably on the elevating mechanism of a truck for handling the load. Popular types are fork extension clamps, rotating devices, side shifters, load stabilizers, rams, and booms.

AUTHORIZED: Assigned by a duly constituted administrative or regulatory authority.

AUXILIARY HOIST: Supplemental hoisting unit of lighter capacity and usually higher speed than provided for the main hoist.

BACK STAY: Guy used to support a boom or mast or that section of a main cable, as on a suspension bridge, cableway, etc., leading from the tower to the anchorage.

BAIL: A "U-shaped" member of a bucket, socket, or other fitting.

BASKET OR SOCKET: The conical portion of a socket into which a splayed rope end is inserted and secured with zinc.

BATTERY-ELECTRIC TRUCK: An electric truck in which the power source is a storage battery.

BECKET LOOP: A loop of small rope or strand fastened to the end of a large wire rope to facilitate installation.

BENDING STRESS: Stress imposed on wires of a wire rope by bending. This stress need not be added to direct load stresses. When sheaves and drums are of suitable size, it does not affect the normal life of the wire rope.

BOOM LINE: A wire rope for supporting or operating the boom on derricks, cranes, draglines, shovels, etc.

BRAKE: A device used for retarding or stopping motion by friction or electromagnetic means.

BRAKE, DRAG: A brake which provides retarding force without external control.

BRAKE, HOLDING, OR PARKING: A brake that automatically sets and prevents motion when power is off.

DRAFT

DEPARTMENT OF ENERGY HOISTING & RIGGING MANUAL	TITLE: TERMINOLOGY AND DEFINITIONS NUMBER: 1.0 REV: 00/91
---	--

BRAKING, COUNTERTORQUE: Method of control in which the power to the motor is reversed to develop torque in the opposite direction.

BRAKING, DYNAMIC: A method of controlling crane-motor speeds when in the overhauling condition to provide a retarding force.

BRAKING, MECHANICAL: A method of retarding motion by friction.

BRAKING, REGENERATIVE: Form of dynamic braking in which the electrical energy generated is fed back into the power system.

BREAKING STRENGTH: The measured load required to break a cable or chain.

BRIDGE: That part of the crane consisting of girders, walkways, railings, trucks, and drive mechanisms which carries the trolley or trolleys.

BRIDGE TRAVEL: Horizontal travel of the crane parallel with runway rails.

BRIDLE SLING: A two-part sling attached to a single-part line. The legs of the sling are spread to divide and equalize the load.

BULL RING: The main large ring of a sling to which sling legs are attached.

BUMPER (BUFFER): An energy-absorbing device for reducing impact when a moving crane or trolley reaches the end of its permitted travel; or when two moving cranes or trolleys come into contact.

CAB: The operator's compartment.

CABLE: A term loosely applied to wire ropes, wire strands, manila ropes, and electrical conductors.

CABLE-LAID WIRE ROPE: A type of wire rope consisting of several independent wire ropes laid into a single wire rope.

CABLE CROWD ROPE: A wire rope used to force the bucket of a power shovel into the material being handled.

CANTILEVER TRUCK: A self-loading counterbalanced or noncounterbalanced truck equipped with cantilever load-engaging means, such as forks.

CARRIAGE: A support structure for forks or attachments, generally roller-mounted, traveling vertically within the mast of a cantilever truck.

CENTER: A single wire or fiber in the center of a strand about which the wires are laid.

CENTER CONTROL: The operator-control position is located near the center of the truck.

CHOKER ROPE: A short wire-rope sling used to form a slip noose around the object to be moved or lifted (see Figure 1-1).

CIRCUMFERENCE: Measured perimeter of a circle circumscribing the wires of a strand or the strands of a wire rope.

CLAMP, STRAND: A fitting for forming a loop at the end of a length of strand consisting of two grooved plates and bolts.

DEPARTMENT OF ENERGY HOISTING & RIGGING MANUAL	TITLE: TERMINOLOGY AND DEFINITIONS
	NUMBER: 1.0 REV: 00/91

CLEARANCE: The distance by which one object clears another, or the clear space between them.

CLEVIS: A "U-shaped" fitting with pins.

CLIP: Fitting for clamping two parts of wire rope.

CLOSED SOCKET: Wire-rope fitting consisting of an integral becket and bail.

CLOSING LINE: Wire rope that closes a clamshell or orange-peel bucket and then operates as a hoisting rope.

COIL: Circular bundle of wire rope not packed on a reel.

COLLECTOR: Contacting device mounted on bridge or trolley for collecting current from conductor system.

****COME-ALONG:** Device for making a temporary grip and exerting tension on a wire rope.

CONDUCTOR: Wire, angles, bars, tees, or special sections mounted to transmit current to the collectors.

CONICAL DRUM: Grooved hoisting drum of varying diameter.

CONSTRUCTION: Design of wire rope including number of strands, number of wires per strand, and arrangement of wires in each strand.

CONTINUOUS BEND: Reeving of wire rope over sheaves and drums so that it bends in one direction, as opposed to reverse bend.

CONTROLLER: An operator's device for regulating the power delivered to the motor or other equipment.

CONTROLLER, SPRING RETURN: A controller which, when released, will return automatically to a neutral position.

CORE: Core member of a wire rope about which the strands are laid. It may be fiber, a wire strand, or an independent wire rope.

CORING LINE: Wire rope used to operate the coring tool for taking core samples during the drilling of a well.

CORROSION: Chemical decomposition by exposure to moisture, acids, alkalis, or other destructive agents.

CORRUGATED: A term used to describe the grooves of a sheave or drum when worn so as to show the impression of a wire rope.

COUNTERBALANCED TRUCK: A truck equipped with load-engaging means wherein all the load during normal transporting is external to the polygon formed by the wheel contacts.

COVER WIRES: The outer layer of wires.

CRANE: A machine for lifting and lowering a load vertically and moving it horizontally with the hoisting mechanism an integral part of the machine.

CRANE SERVICE:

Normal Service: That service which involves operating at less than 85% rated capacity and not more than 10 lift cycles per hour, except for isolated instances.

DEPARTMENT OF ENERGY HOISTING & RIGGING MANUAL	TITLE: TERMINOLOGY AND DEFINITIONS NUMBER: 1.0 REV: 00/91
---	--

Heavy Service: That service which involves operating at 85–100% of rated capacity or in excess of 10 lift cycles per hour as a regular specified procedure.

Severe Service: That service which involves normal or heavy service with abnormal operating conditions.

CRANES, TYPES OF:

Automatic Crane: A crane which, when activated, operates through a preset cycle or cycles.

Cab–Operated Crane: A crane controlled by an operator in a cab located on the bridge or trolley.

Cantilever Gantry Crane: A gantry or semi–gantry crane in which the bridge girders or trusses extend transversely beyond the crane runway on one or both sides.

Floor–Operated Crane: A crane which is pendant or nonconductive rope controlled by an operator on the floor or an independent platform.

Gantry Crane: A crane similar to an overhead crane, except that the bridge for carrying the trolley or trolleys is rigidly supported on two or more legs running on fixed rails or other runway.

Overhead Crane: A crane with a movable bridge carrying a movable– or fixed–hoisting mechanism and traveling on an overhead fixed–runway structure.

Power–Operated Crane: A crane whose mechanism is driven by electricity, air, hydraulic, or internal combustion.

Pulpit–Operated Crane: A crane operated from a fixed operator station not attached to the crane.

Remote–Operated Crane: A crane controlled by an operator not in a pulpit nor in a cab attached to the crane, by any method other than pendant or rope control (e.g., radio–controlled crane).

Semi–Gantry Crane: A gantry crane with one end of the bridge rigidly supported on one or more legs that run on a fixed rail or runway, the other end of the bridge being supported by a truck running on an elevated rail or runway.

Wall or Jib Crane: A crane having a jib with or without trolley, and supported from a side wall or line of columns of a building.

CRITICAL DIAMETER: Diameter of the smallest bend for a given wire rope which permits the wires and strands to adjust themselves by relative movement while remaining in their normal position.

CRITICAL ITEM: A part, assembly, component, or piece of equipment designated as critical by a purchaser or facility operator, because the dropping, upset, or collision of it could: (a) cause damage that would result in schedule delay; (b) cause undetectable damage that could jeopardize future operation or safety of the facility; and (c) result in significant release of radioactivity or other undesirable condition. Critical items may include pumps, heat exchangers, piping subassemblies, other primary–system components, fuel assemblies, large radiation–shielded shipping casks, or other items which require special care in handling because of size, weight, installation in close–tolerance receptors, fragility, extreme susceptibility to damage, or other unusual factors.

CRITICAL SERVICE: The use of equipment or tackle for hoisting, rigging, or handling of High–Consequence or Special–High–Consequence Loads.

DEPARTMENT OF ENERGY HOISTING & RIGGING MANUAL	TITLE: TERMINOLOGY AND DEFINITIONS NUMBER: 1.0 REV: 00/91
---	--

CYLINDRICAL DRUM: Hoisting drum of uniform diameter.

DECELERATION STRESS: Additional stress imposed on a wire rope due to decreasing the velocity of the load.

DEFLECTION:

- (a) Sag of a rope in a span. Usually measured at midspan as the depth from a chord joining the tops of the two supports.
- (b) Any deviation from a straight line.

DESIGNATED: Selected or assigned by the employer or the employer's representative as being qualified to perform specific duties.

DIAMETER: Distance measured across the center of a circle circumscribing the wires of a strand or the strands of a wire rope.

DIESEL-ELECTRIC TRUCK: An electric truck in which the power source is a diesel-engine-driven generator.

DOCKBOARD: A portable or fixed device for spanning the gap or compensating for difference in level between loading platforms and carriers.

DOG-LEG: Permanent short bend or kink in a wire rope caused by improper use.

DRAGLINE: Wire rope used to pull an excavating or drag bucket.

DRIVE: Motor, coupling, brake and gear case, or gear cases to propel bridge, trolley, or hoist.

DRIVE GIRDER: Girder on which is mounted the bridge drive, cross shaft, walk, railing, and operator's cab.

DRUM: A cylindrical-flanged barrel of uniform (cylindrical drum) or tapering (conical drum) diameter on which the cable is wound for operation or storage. It may be smooth or grooved.

ELASTIC LIMIT: Limit of stress above which a permanent deformation takes place within the material. This limit is approximately 55-65% of breaking strength of steel-wire ropes.

ELECTRIC TRUCK: A truck in which the principal energy is transmitted from power source to motor(s) in the form of electricity.

END CONTROL: The operator-control position is located at the end opposite the load end of the truck.

EQUALIZER: Device used to compensate for unequal length or stretch of a hoist rope.

EQUALIZING SLINGS: Slings composed of wire rope and equalizing fittings.

EQUALIZING THIMBLES: Special type of fitting used as a component part of some wire-rope slings.

EYE OR EYE SPLICE: A loop with or without a thimble formed in the end of a wire rope.

FACTOR OF SAFETY: Ratio of ultimate strength to the design working stress.

FAIL-SAFE: A provision designed to automatically stop or safely control any motion in which a malfunction occurs.

DEPARTMENT OF ENERGY HOISTING & RIGGING MANUAL	TITLE: TERMINOLOGY AND DEFINITIONS NUMBER: 1.0 REV: 00/91
---	---

FATIGUE: Term commonly applied to progressive fracture of any load-supporting member.

FIBER CENTERS: Cords or rope made of vegetable fiber used in the center of a strand.

FIBER CORES: Cords or rope made of vegetable fiber used in core of a wire rope.

FIRST POINT: The first setting on the operator's controller which starts crane motion (slowly) in each direction.

FITTING: Any accessory used as an attachment for wire rope.

FLAG: Mark or marker on a rope to designate position of load.

FLAT ROPE: Wire rope made of parallel alternating right-lay and left-lay ropes sewn together by relatively soft wires.

FLATTENED STRAND ROPE: A wire rope with either oval- or triangular-shaped strands which present a flattened rope surface.

FLEET ANGLE: Angle between position of a rope at the extreme end wrap on a drum and a line drawn perpendicular to the axis of the drum through the center of the nearest fixed sheave.

FORKS: Horizontal tine-like projections, normally suspended from the carriage, for engaging and supporting loads.

FORK HEIGHT: The vertical distance from the floor to the load-carrying surface adjacent to the heel of the forks with mast vertical, and in the case of Reach Trucks, with the forks extended.

FORKLIFT TRUCK: A high lift self-loading truck, equipped with load carriage and forks, for transporting and tiering loads (see Figure 1-7).

GALVANIZE: To coat with zinc to protect against corrosion.

GALVANIZED ROPE: Rope made of galvanized wire.

GALVANIZED STRAND: Strand made of galvanized wire.

GALVANIZED WIRE: Wire coated with zinc.

GAS-ELECTRIC TRUCK: An electric truck in which the power source is a gasoline or LP gas-engine-driven generator.

GROMMET: An endless 7-strand wire rope made from one continuous length of strand.

GROOVED DRUM: Drum with grooved surface to accommodate and guide the rope.

GROOVES: Depressions in the periphery of a sheave or drum for positioning and supporting a rope.

GUY LINE: Strand or rope, usually galvanized, for holding a structure in position.

HANDLING FIXTURE: A cradle, handling structure, shipping fixture, or container designed specifically to facilitate support, lifting, or handling of a component during fabrication, loading, shipping, storage, or installation.

DEPARTMENT OF ENERGY HOISTING & RIGGING MANUAL	TITLE: TERMINOLOGY AND DEFINITIONS	
	NUMBER: 1.0	REV: 00/91

HIGH-LIFT TRUCK: A self-loading truck equipped with an elevating mechanism designed to permit tiering. Popular types are high-lift platform trucks (see Figure 1-7).

HIGH-LIFT PLATFORM TRUCK: A self-loading truck equipped with an elevating mechanism intended primarily for transporting and tiering loaded skid platforms (see Figure 1-7)

HOIST: A device which applies a force for vertical lifting or lowering (see Figure 1-2).

HOLDING LINE: Wire rope on a clamshell or orange-peel bucket that holds the bucket while the closing line is released to dump the load.

HOOK LOAD: The total live load supported by the hook of a crane, derrick, or other hoisting equipment, including the load, slings, spreader bars, and other tackle not part of the load but supported by the hook and required for handling of the load.

IDLER: Sheave or roller used to guide or support a rope.

INDEPENDENT WIRE-ROPE CORE: Wire rope used as the core of a larger rope.

INDUSTRIAL TRACTOR: A powered industrial vehicle designed primarily to draw one or more nonpowered trucks, trailers, or other mobile loads.

INNER WIRES: All wires of a strand except surface or cover wires.

INTERNAL-COMBUSTION ENGINE TRUCK: A truck in which the power source is a gas or diesel engine.

INTERNALLY LUBRICATED: Wire rope or strand having all wires coated with lubricant.

KINK: Permanent distortion of the wires and strands resulting from sharp bends.

LAGGING: External wood covering on a reel of rope or strand.

LANG-LAY ROPE: Wire rope in which the wires in the strands and the strands in the rope are laid in the same directions.

LAY: The lengthwise distance on a wire rope in which a strand makes one complete turn around the rope (see Figure 1-3).

Left Lay:

- (a) **Strand:** Strand in which the cover wires are laid in a helix having a left-hand pitch, similar to a left-hand screw.
- (b) **Rope:** Rope in which the strands are laid in a helix having a left-hand pitch, similar to a left-hand screw.

Right Lay:

- (a) **Strand:** Strand in which the cover wires are laid in a helix having a right-hand pitch, similar to a right-hand screw.
- (b) **Rope:** Rope in which the strands are laid in a helix having a right-hand pitch, similar to a right-hand screw.

DEPARTMENT OF ENERGY HOISTING & RIGGING MANUAL	TITLE: TERMINOLOGY AND DEFINITIONS NUMBER: 1.0 REV: 00/91
---	--

LIFT:

- (a) Maximum safe vertical distance through which the hook can travel.
- (b) The hoisting of a load.

LIFT, HIGH-CONSEQUENCE: High-Consequence Lifts and items are parts, components, assemblies, or lifting operations designated as such by the customer or program organizations, because the effect of dropping, upset, or collision of items could:

- (a) Cause significant work delay.
- (b) Cause undetectable damage resulting in future operational or safety problems.
- (c) Result in significant release of radioactivity or other undesirable conditions.
- (d) Present a potentially unacceptable risk of personnel injury or property damage.

This category of lift applies when the load imposed upon the equipment to be used will be less than 75% of the rated capacity.

LIFT, ORDINARY: Any lift not designated as a High-Consequence Lift or a Special-High-Consequence Lift.

LIFT, SPECIAL-HIGH-CONSEQUENCE: High-Consequence Lifts during which the load imposed upon the material-handling equipment to be used will equal or exceed 75% of the rated capacity.

LINE: Rope used for supporting and controlling a suspended load.

LOAD: Total superimposed weight on the load block or hook.

LOAD BLOCK: The assembly of hook or shackle, swivel, bearing, sheaves, pins, and frame suspended by the hoisting ropes.

LOAD-BACKREST EXTENSION: A device extending vertically from the fork carriage frame.

LOAD-BEARING PARTS: Any part of a material-handling device in which the induced stress is influenced by the hook load. A *primary load-bearing part* is one, the failure of which could result in dropping, upset, or uncontrolled motion of the load. Load-bearing parts which, if failed would result in no more than stoppage of the equipment without causing dropping, upset, or loss of control of the load, are not considered to be primary load-bearing parts.

LOAD CENTER (FORKLIFTS): The horizontal longitudinal distance from the intersection of the horizontal load-carrying surfaces and vertical load-engaging faces of the forks (or equivalent load-positioning structure) to the center of gravity of the load.

MAGNET: An electromagnetic device carried on a crane hook to pick up loads magnetically.

MAIN HOIST: The hoist mechanism provided for lifting the maximum-rated load.

MAN TROLLEY: A trolley having an operator's cab attached thereto.

MARLINE SPIKE: Tapered steel pin used in splicing wire rope.

DEPARTMENT OF ENERGY HOISTING & RIGGING MANUAL	TITLE: TERMINOLOGY AND DEFINITIONS NUMBER: 1.0 REV: 00/91
---	--

MESSENGER STRAND: Galvanized strand or bronze strand used to support telephone and electrical cables.

MODULUS OF ELASTICITY: Mathematical quantity giving the ratio, within the elastic limit, between a definite range of unit stress on a wire rope to the corresponding elongation.

MOUSING: A method of bridging the throat opening of a hook to prevent the release of load lines and slings, under service or slack conditions, by wrapping with soft wire, rope, heavy tape, or similar materials.

NARROW-AISLE TRUCK: A self-loading truck primarily intended for right-angle stacking in aisles narrower than those normally required by counterbalance trucks of the same capacity (see Figure 1-7).

NONROTATING WIRE ROPE: 18 x 7 wire rope consisting of a left-lay, lang-lay inner rope covered by 12 seven-wire strands right-lay, regular-lay.

OPEN SOCKET: Wire-rope fitting consisting of a "basket" and two "ears" with a pin.

ORDER-PICKER TRUCK, HIGH-LIFT: A high-lift truck controllable by the operator stationed on a platform movable with the load-engaging means and intended for (manual) stock selection. The truck may be capable of selfloading and/or tiering (see Figure 1-7).

OVERHEAD GUARD: A framework fitted to a truck over the head of a riding operator.

PALLET TRUCK: A self-loading, low-lift truck equipped with wheeled forks of dimensions to go between the top and bottom boards of a double-faced pallet, and having wheels capable of lowering into spaces between the bottom boards, so as to raise the pallet off the floor for transporting (see Figure 1-7).

PARKING BRAKE: A device to prevent the movement of a stationary vehicle.

PEENING: Permanent distortion of outside wire in a rope caused by pounding.

PERSON-IN-CHARGE: The manager or other responsible person (other than the equipment operator) appointed to be responsible for the safe handling of critical loads and for the safe handling of noncritical items in, around, or above spaces in which critical items are located.

POWERED INDUSTRIAL TRUCK: A mobile, power-driven vehicle used to carry, push, pull, lift, stack, or tier material.

PREFORMED WIRE ROPE: Wire rope in which the strands are permanently shaped, before fabrication into the rope, to the helical form they assume in the wire rope.

PREFORMED STRAND: Strand in which the wires are permanently shaped, before fabrication in the strands, to the helical form they assume in the strand.

PRESTRESSING: Stressing a wire rope or strand before use under such a tension and for such a time that the constructional stretch is largely removed.

PUBLIC CARRIER: A company engaged in the public transportation of goods for hire.

QUALIFIED: A person, who by possession of a recognized degree, certificate, or professional standing, or who by extensive knowledge, training, and experience, has successfully demonstrated his/her ability to solve or resolve problems relating to the subject matter and work.

DEPARTMENT OF ENERGY HOISTING & RIGGING MANUAL	TITLE: TERMINOLOGY AND DEFINITIONS NUMBER: 1.0 REV: 00/91
---	--

QUALIFIED ENGINEER: QUALIFIED ENGINEERING ORGANIZATION: An engineer or engineering organization whose competence in evaluation of the type of equipment in question has been demonstrated to the satisfaction of the cognizant manager.

QUALIFIED INSPECTOR: One whose competence is recognized by the cognizant manager and whose qualification to perform specific inspection activities has been determined verified and attested to in writing.

QUALIFIED OPERATOR: One who has had appropriate and approved training, including satisfactory completion of both written and operational tests to demonstrate knowledge and skill in the safe operation of the equipment to be used.

QUALIFIED RIGGER: One whose competence in this skill has been demonstrated by experience satisfactory to the appointed person.

The term "Rigger" or "Qualified Rigger" in this Manual refers to the function performed, and in no way relates to the workmen's classification in any union or bargaining unit.

QUALIFIED RIGGING SPECIALIST: One whose competence in this skill has been demonstrated by extensive experience (including rigging and handling of items of a nature akin to the loads to be handled in accordance with this Manual) satisfactory to the appointed person.

RATED CAPACITY: The manufacturer's rated capacity. The maximum hook load which a piece of hoisting equipment is designed to carry; also the maximum load which an industrial truck or a sling, hook, shackle, or other rigging tackle is designed to carry.

REACH TRUCK: A self-loading truck, generally high-lift, having loadengaging means mounted so it can be extended forward under control to permit a load to be picked up and deposited in the extended position and transported in the retracted position (see Figure 1-7).

REEL: The flanged spool on which wire rope or strand is wound for storage or shipment.

REGULAR-LAY ROPE: Wire rope in which the wires in the strands and the strands in the rope are laid in opposite directions.

REVERSE BEND: Reeving of a wire rope over sheaves and drums so that it bends in opposite directions.

RIDER TRUCK: A truck that is designed to be controlled by a riding operator.

ROLLERS: Relatively small-diameter cylinders or wide-faced sheaves for supporting or guiding ropes.

RUNNING SHEAVE: A sheave which rotates as the load block is raised or lowered.

RUNWAY: Assembly of rails, girders, brackets, and framework on which a crane operates.

SAFE-WORKING LOAD: Proper load which the rope may carry economically and safely.

SEALE: A strand construction having one size of cover wires with the same number of one size of wires in the inner layer and each layer having the same length and direction of lay. Most common construction is one center wire, nine inner wires, and nine cover wires.

SEIZE: To bind securely the end of a wire rope or strand with seizing wire or strand.

DEPARTMENT OF ENERGY HOISTING & RIGGING MANUAL	TITLE: TERMINOLOGY AND DEFINITIONS
	NUMBER: 1.0 REV: 00/91

SEIZING STRAND: Small strand, usually of seven wires, made of soft-annealed-iron wire.

SEIZING WIRE: A soft-annealed-iron wire.

SERVE: To cover the surface of a wire rope or strand with a wrapping of wire.

SHACKLE: A type of clevis normally used for lifting (see Figure 1-4).

SHEAVE: A grooved pulley.

SIDE LOADER: A self-loading truck, generally high-lift, having load-engaging means mounted in such a manner that it can be extended laterally under control to permit a load to be picked up and deposited in the extended position and transported in the retracted position.

SIDE PULL: That portion of the hoist pull acting horizontally when the hoist lines are not operated vertically.

SLINGS: Wire ropes or chains made into forms, with or without fittings, for handling loads (see Figure 1-5).

SLINGS, BRAIDED: A very flexible sling composed of several individual wire ropes braided into a single sling.

SMOOTH-FACED DRUM: Drum with a plain face, not grooved.

SPAN: The horizontal distance center-to-center of runway rails.

SPECIAL-RATED CAPACITY: The maximum hook load which a piece of hoisting equipment, or the maximum working load which an industrial truck or piece of rigging tackle is permitted to carry, based on its present condition and the operational conditions as determined by an engineering evaluation, load test, or both. The special-rated capacity may be equal to but not greater than the rated capacity of equipment established by the manufacturer.

SPIRAL GROOVE: Groove which follows the path of a helix around the drum, as the thread of a screw.

SPLICING: Interweaving of two ends of ropes so as to make a continuous or endless length without appreciably increasing the diameter. Also making a loop or eye in the end of a rope by tucking the ends of the strands.

STAINLESS-STEEL ROPE: Wire rope made of chrome-nickel steel wires having great resistance to corrosion.

STEEL-CLAD ROPE: Rope with individual strands spirally wrapped with flat steel wire.

STIRRUP: The U-bolt or eyebolt attachment on a bridge socket.

STRAND: An arrangement of wires helically laid about an axis, or another wire or fiber center to produce a symmetrical section.

SWAGED FITTINGS: Fittings in which wire rope is inserted and attached by a cold-forming method.

SWITCH: A device for making, breaking, or for changing the connections in an electric circuit.

SWITCH, EMERGENCY STOP: A manually or automatically operated electric switch to cut off electric power independently of the regular operating controls.

SWITCH, LIMIT: A switch which is operated by some part or motion of a power-driven machine or equipment to alter the electrical circuit associated with the machine or equipment.

DEPARTMENT OF ENERGY HOISTING & RIGGING MANUAL	TITLE: TERMINOLOGY AND DEFINITIONS NUMBER: 1.0 REV: 00/91
---	--

SWITCH, MAIN: A switch controlling the entire power supply to the crane, often called the disconnect switch.

TAG LINE: A rope used to prevent rotation of a load.

TAPERING AND WELDING: Reducing the diameter of the end of a wire rope and welding it to facilitate reeving.

THIMBLE: Grooved-metal fitting to protect the eye of a wire rope (see Figure 1-6).

TIERING: The process of placing one load on or above another.

TINNED WIRE: Wire coated with tin.

TROLLEY: The unit consisting of frame, trucks, trolley drive, and hoisting mechanism moving on the bridge rails in a direction at right angles to the crane runway.

TROLLEY GIRTS: Structural members which are supported on the trolley trucks and contain the upper sheave assemblies.

TROLLEY TRAVEL: Horizontal travel of trolley at right angles to runway rails.

TROLLEY TRUCK: Assembly consisting of wheels, bearings, axles, and structural-supporting hoist mechanism and load girts.

TRUCK, INDUSTRIAL: See Figure 1-7, Types of Trucks (four pages).

TURNBUCKLE: Device attached to wire rope for making limited adjustments in length. It consists of a barrel and right- and left-hand threaded bolts.

TWO-BLOCKING: The act of continued hoisting in which the load-block and head-block assemblies are brought into physical contact, thereby preventing further movement of the load block and creating shock loads to the rope and reeving system.

VERIFICATION: A procedure in which a design, calculation, drawing, procedure, instruction, report, or document is checked and signed by one or more parties. The person designated to sign verifies, based on personal observation, certified records, or direct reports, that a specific action has been performed in accordance with specified requirements.

WEDGE SOCKET: Wire-rope fitting in which the rope end is secured by a wedge.

WHEEL BASE: Distance between centers of outermost wheels for bridge and trolley trucks.

WHEEL LOAD: The load on any wheel with the trolley and lifted load (rated load) positioned on the bridge to give maximum-loading conditions.

WIRE ROPE: A plurality of strands laid helically around an axis or a core.

WIRE (ROUND): Single continuous length of metal, cold drawn from a rod.

WIRE (SHAPED): A single continuous length of metal either cold drawn or cold rolled from a rod.

DEPARTMENT OF ENERGY HOISTING & RIGGING MANUAL	TITLE: TERMINOLOGY AND DEFINITIONS
	NUMBER: 1.0 REV: 00/91

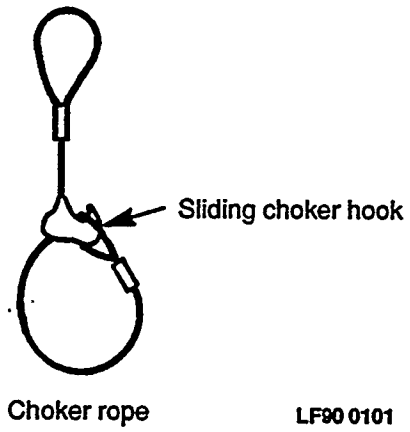

Figure 1-1

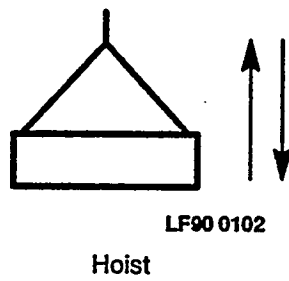

Figure 1-2

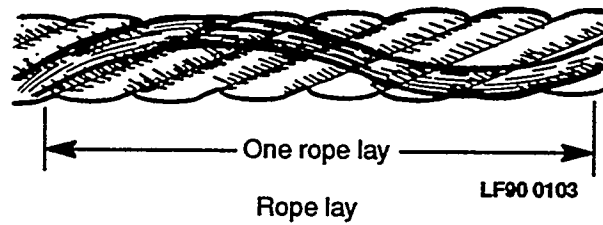
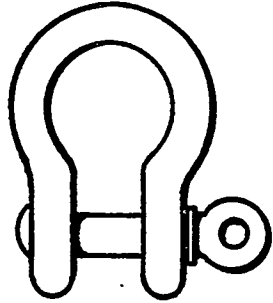
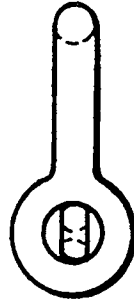

Figure 1-3

DEPARTMENT OF ENERGY HOISTING & RIGGING MANUAL	TITLE: TERMINOLOGY AND DEFINITIONS NUMBER: 1.0 REV: 00/91
---	---



Shackle



LF90 0104

Figure 1-4

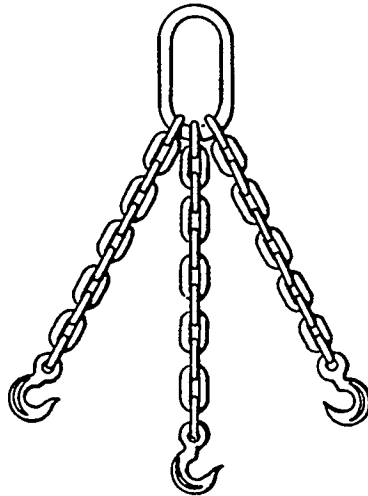
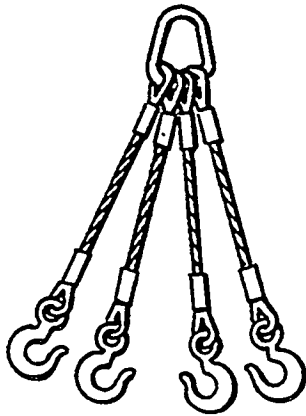

Slings

Figure 1-5

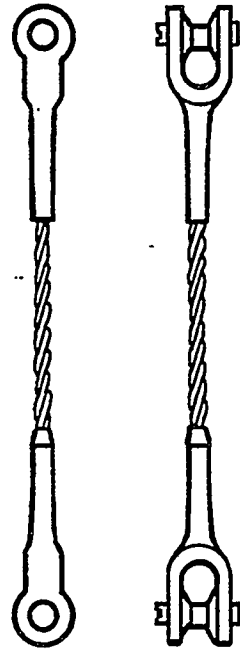

LF90 0105

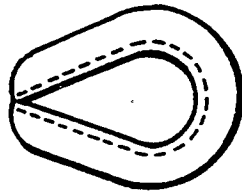

Thimble



LF90 0106

Figure 1-6

DEPARTMENT OF ENERGY HOISTING & RIGGING MANUAL	TITLE: TERMINOLOGY AND DEFINITIONS
	NUMBER: 1.0 REV: 00/91

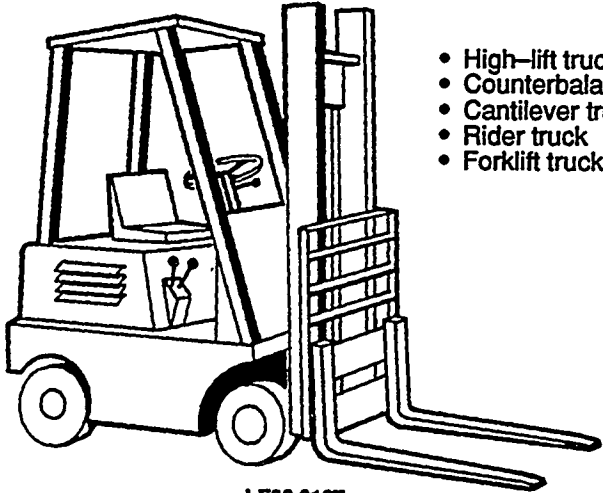

- High-lift truck
- Counterbalanced truck
- Cantilever truck
- Rider truck
- Forklift truck

LF90 0107

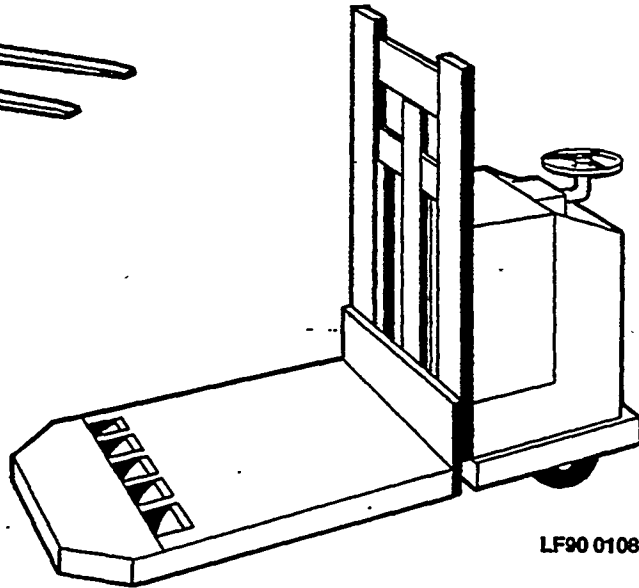

- High-lift truck
- High-lift platform truck

LF90 0108

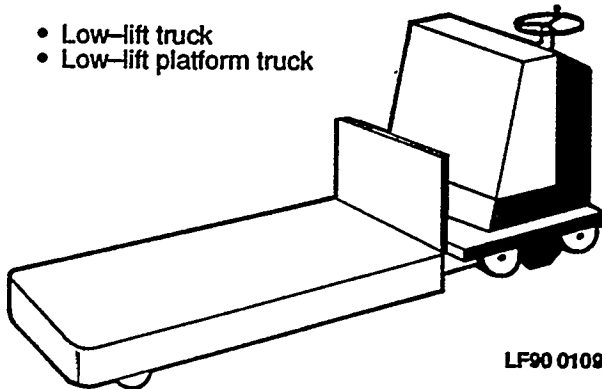

- Low-lift truck
- Low-lift platform truck

LF90 0109

Figure 1-7

**DEPARTMENT OF
ENERGY
HOISTING & RIGGING
MANUAL**

TITLE: TERMINOLOGY AND DEFINITIONS

NUMBER: 1.0

REV: 00/91

- Motorized hand truck
- Pallet truck

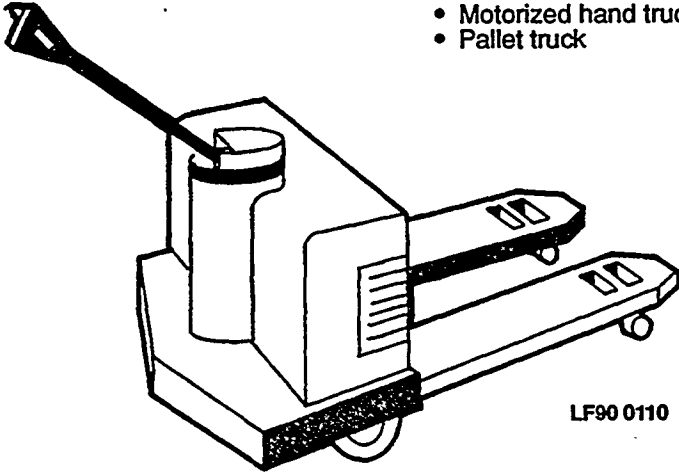

LF90 0110

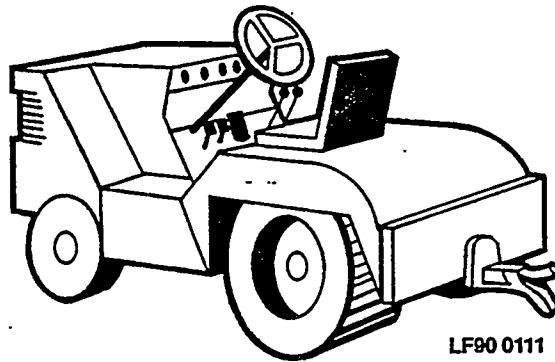

LF90 0111

- Industrial tractor

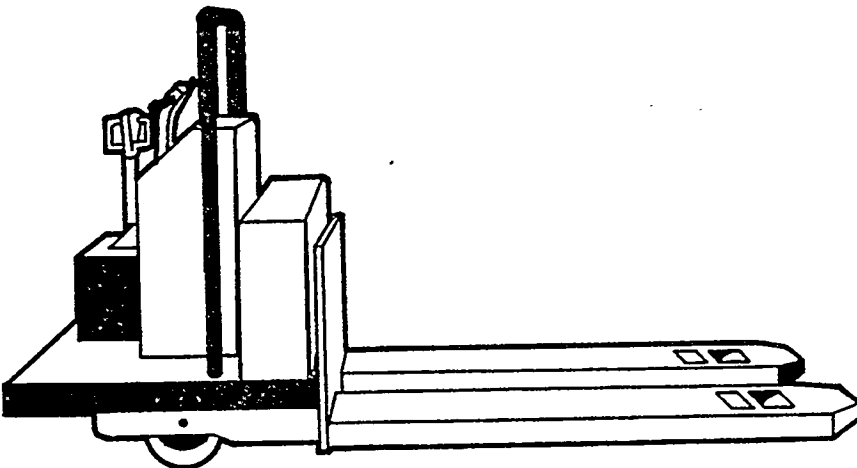

- Motorized hand/rider truck

LF90 0112

Figure 1-7. (continued)

DEPARTMENT OF ENERGY HOISTING & RIGGING MANUAL	TITLE: TERMINOLOGY AND DEFINITIONS NUMBER: 1.0 REV: 00/91
---	--

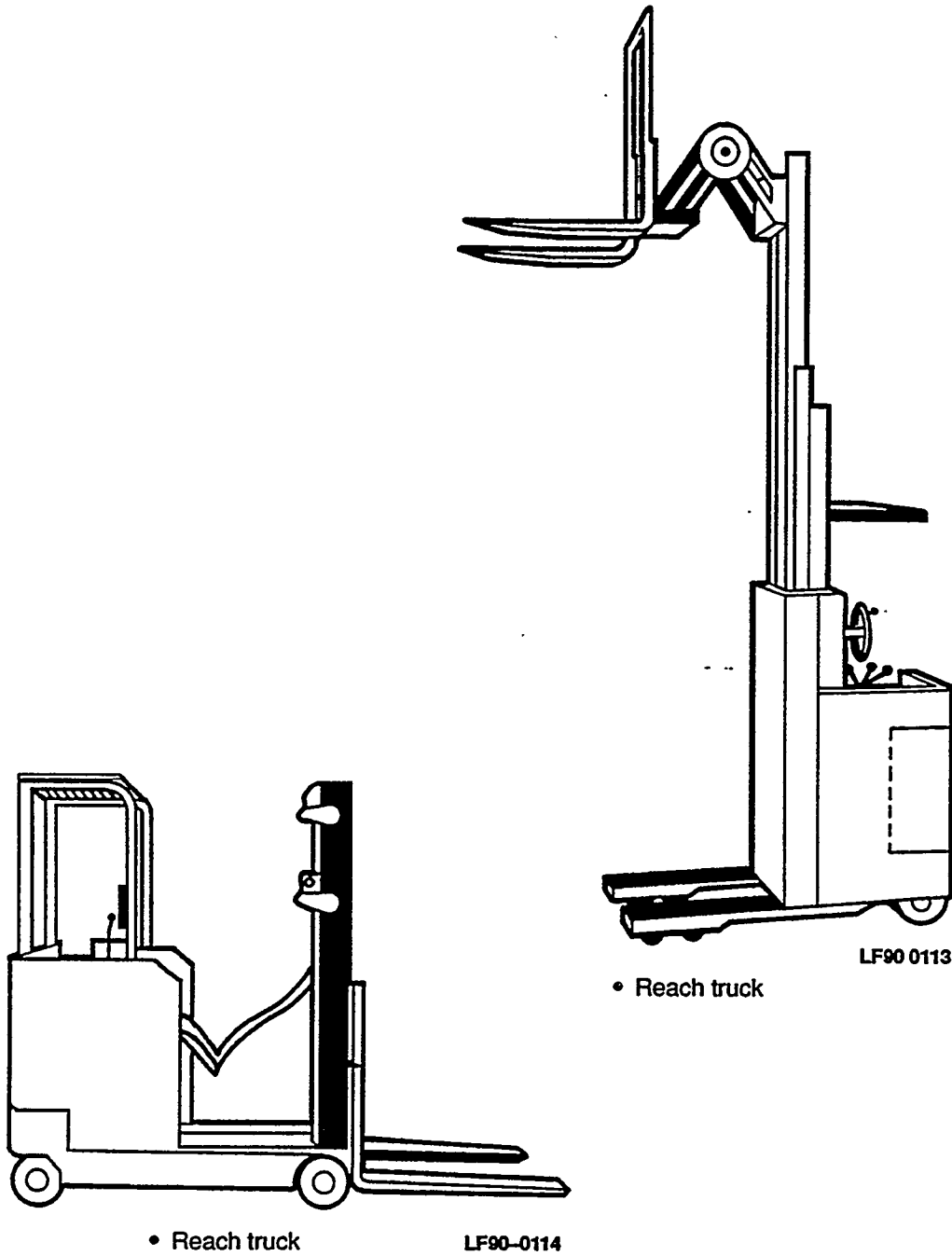
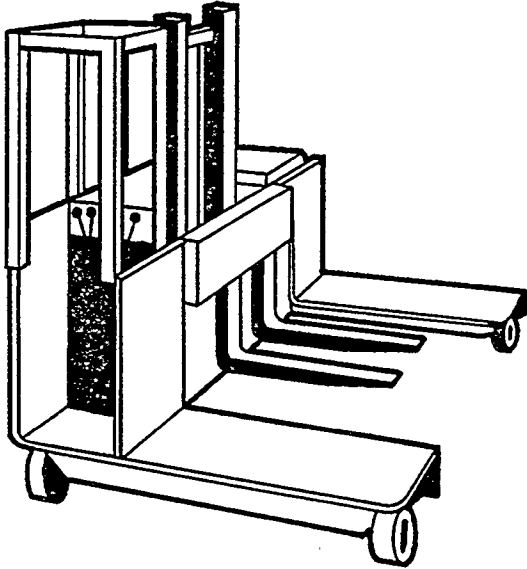

Figure 1-7. (continued)

DEPARTMENT OF ENERGY HOISTING & RIGGING MANUAL	TITLE: TERMINOLOGY AND DEFINITIONS NUMBER: 1.0 REV: 00/91
---	---



• Side-loader truck

LF90-0115

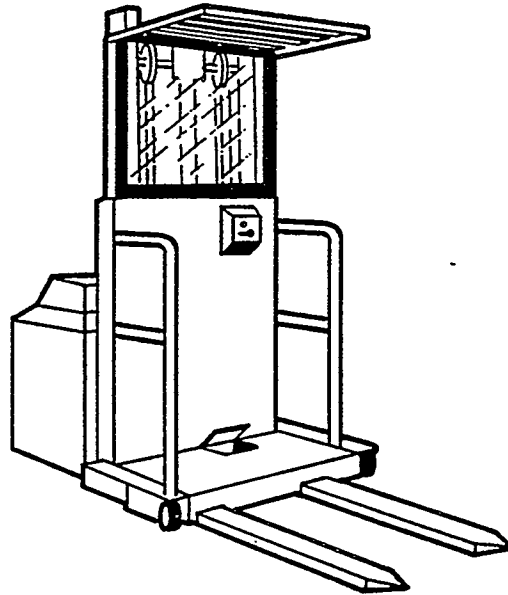

• Order picker truck, high-lift

LF90-0116

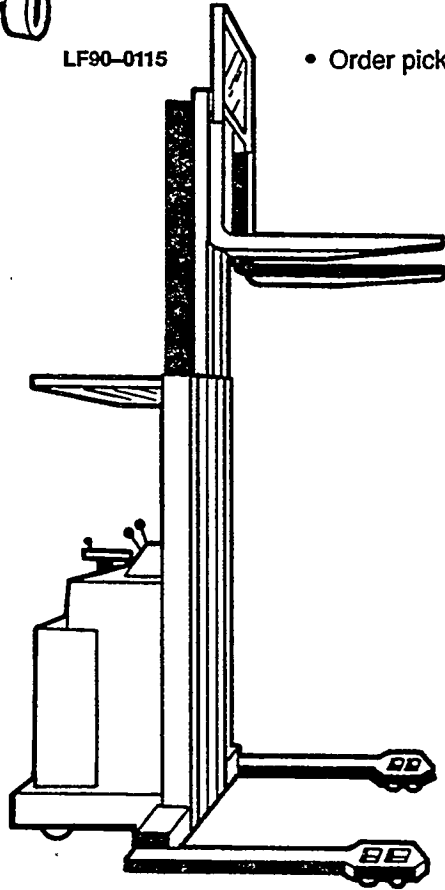

• Narrow aisle truck

LF90-0117

Figure 1-7. (continued)

**DEPARTMENT OF
ENERGY
HOISTING & RIGGING
MANUAL**

TITLE: OPERATOR TRAINING AND QUALIFICATION

NUMBER: 2.0

REV: 00/91

CONTENTS

2.1	Operator Training	2-1
2.1.1	Qualified Operators	2-1
2.1.2	Qualified Operator Training Programs	2-2
2.2	Person-in-Charge (PIC)	2-5
2.3	Qualified Rigger Training	2-5
2.3.1	Qualified Riggers	2-5
2.3.2	Qualified Rigger Training Programs	2-6
2.4	Physical Requirements	2-7
2.4.1	General	2-7
2.4.2	Full Time Operators	2-7
2.5	Qualification Examinations (Suggested Scope)	2-8
2.5.1	General Written Examinations	2-8
2.5.2	Purpose of Exam	2-9

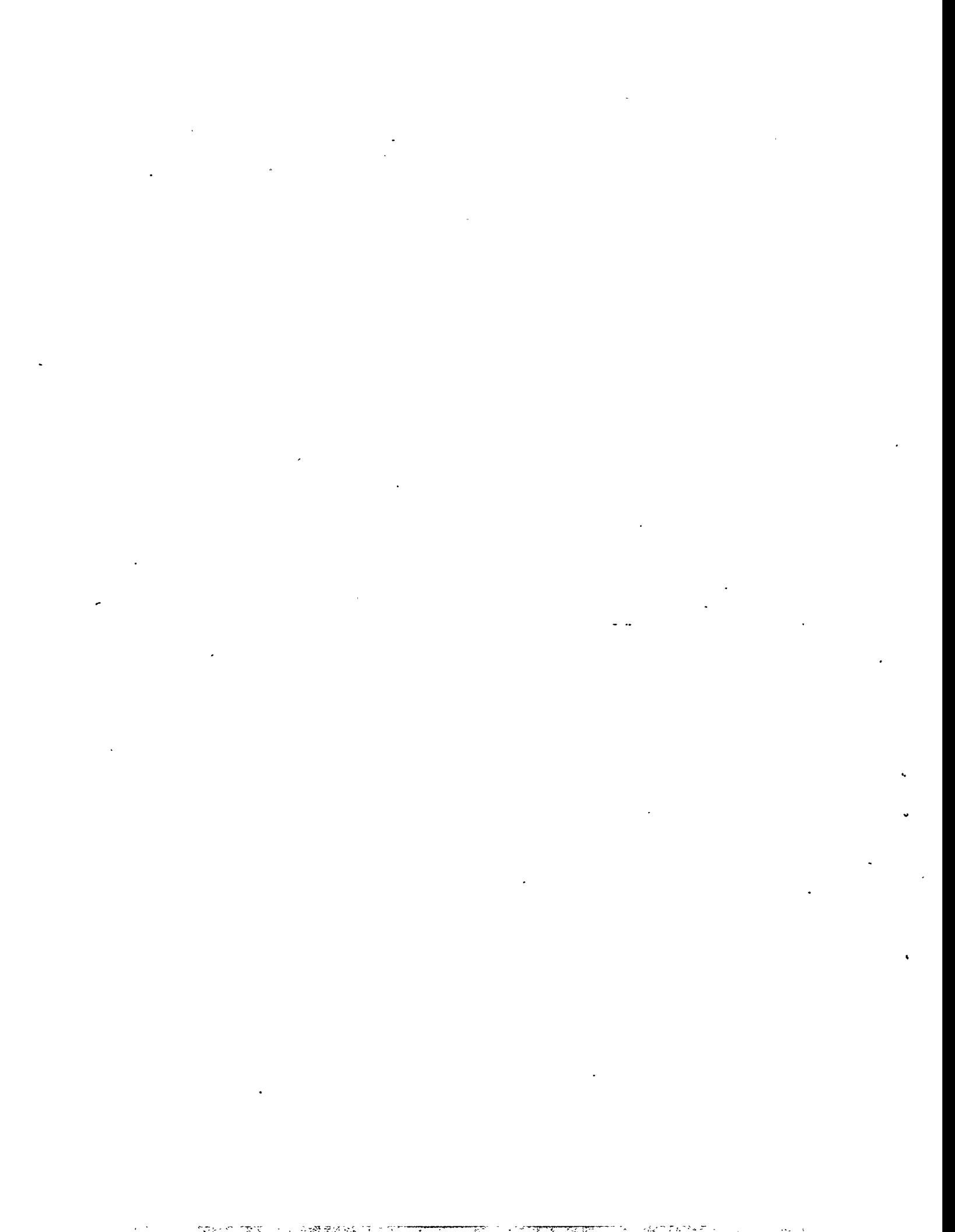

DEPARTMENT OF ENERGY HOISTING & RIGGING MANUAL	TITLE: OPERATOR TRAINING AND QUALIFICATION
	NUMBER: 2.0 REV: 00/91

ISSUE NO.

2. OPERATOR TRAINING AND QUALIFICATION

2.1 Operator Training

The use of cranes, forklifts, hoists, in-plant powered industrial trucks, and slings is subject to certain hazards that cannot be met by mechanical means. Only by the exercise of intelligence, care, and good sense can these hazards be met. It is essential to have competent and careful operators, physically and mentally fit, thoroughly trained to the safe operation of the equipment and the handling of the loads. Serious hazards are overloading, dropping or slipping of the load caused by improper hitching or slinging, obstruction to the free passage of the load, or using equipment for a purpose for which it was not intended or designed.

It is necessary that persons who operate this equipment learn and understand the basic information concerning safety for equipment. Also, it is necessary that these persons learn the special requirements for safe handling and use of the equipment which they operate. Since each item of equipment has its own special requirements, employees need additional training to the basic information they received that applies to a general class. The scope of training given in this Manual covers the general needs on an equipment class. Special requirements on individual equipment in the class will require more training on each machine.

Training for equipment operation requires two parts: (1) an information exchange where rules, regulations, requirements, limits, and do's and don'ts are discussed and explained; and (2) the physical application where safe operation is explained, demonstrated by the teacher, tried by the trainee, faults and errors corrected, and checks made during operation to assure that correct physical controls are developed. An employee cannot be a good operator until both parts are learned.

Only Qualified Operators shall be permitted to operate the equipment covered in this Manual.

2.1.1 Qualified Operators

- a. Operators of hoisting equipment shall meet the following requirements:
 - (1) *Age*—Be at least 18 years.
 - (2) *Language*—Understand spoken and written English or a language generally in use at the location.
 - (3) *Physical*—Meet the requirements of Section 2.4.
 - (4) *Knowledge*—Have basic knowledge and understanding of equipment—operating characteristics, capabilities, and limitations including: equipment—rated capacity and effect of variables on capacity, safety features, required operating procedures, and requirements of this Manual.
 - (5) *Skill*—Demonstrate skill in manipulations and control of equipment through all phases of operation.
- b. The initial qualification of Operators shall include:
 - (1) Training on the equipment for which he/she is to be qualified, under the direction of a Qualified Operator designated by management to instruct in the operation of hoisting equipment.

DRAFT

**DEPARTMENT OF
ENERGY
HOISTING & RIGGING
MANUAL**

TITLE: OPERATOR TRAINING AND QUALIFICATIONS

NUMBER: 2.0

REV: 00/91

- (2) Reviewing the applicant's knowledge, including written and oral examinations, and witnessing a demonstration of his/her skills by the instructor.
- (3) Inserting a written record of training, competency, and authorization in the employee's training record (by his/her supervisor). The record shall include identification of the equipment for which the individual is qualified to operate.
- c. Operator qualification is for a period of three years, unless the qualification is revoked sooner by the operator's manager. If operators are disqualified, their manager shall enter the action in their file.
- d. The program for the maintenance of operators qualification shall include:
 - (1) Verification by the operators' manager that the operators are required to operate powered hoisting equipment in the performance of their duties, and that they have been doing so safely and competently.
 - (2) Completion of a written test relevant to the type of equipment used.
 - (3) Completion of field training, if required by the operator's manager.

2.1.2 Qualified Operator Training Programs

- a. All organizations that employ personnel who operate the devices covered in this Manual shall develop training programs, including a means of testing, to assure that the personnel are competent to perform the operations. The Safety organization shall review program content for safety significance and include in their routine audits the administration of the compliance with the training and qualification program established and approved by the cognizant manager.
- b. Training programs for operators should address two levels of required performance.
 - (1) Persons who may operate pendant-controlled cranes, manual hoists, and forklifts as an incidental part of their normal work assignment.
 - (2) Persons whose principal assignment is the operation of the equipment covered in this Manual.
- c. The training programs shall include, but not be limited to:
 - Written tests
 - Field training and trials
 - Personal physical requirements and examinations
 - Trainee status and training procedures
 - High-Consequence operations training and briefing
 - Qualification authority.
 - (1) Crane Operators—Scope of General Coverage

DRAFT

(a) Overhead Traveling Cranes

The basic training for Overhead Traveling Cranes includes:

- (i) Access and egress during normal and emergency conditions
- (ii) Check procedure including:
 - Power—regular and emergency
 - Cables
 - Drum, cable attachment, and windings
 - Controls to limit switch
 - Brakes—mechanical and solenoid
 - Fire extinguisher, signal horns, bells, etc.
 - Handling of hoisting mechanism
- (iii) Operation of controls and test lift
- (iv) Signal reception—hand and sound
- (v) Operating procedures and safe practices
- (vi) Knowledge of terminology as applicable to the equipment to be operated (see Section 1.0)
- (vii) Proper conduct
- (viii) Special requirements for OSHA and DOE
- (ix) Proper shutdown
- (x) Release and lockout of crane for maintenance or overhaul

(b) Gantry Cranes

Basic training for Gantry Cranes includes:

- (i) All applicable parts of c.(1)(a), above
- (ii) Method of procedure for securing crane against windstorms

(c) Mobile Cranes

Basic training for Mobile Cranes includes:

- (i) All applicable parts of c.(1)(a), above
- (ii) Location, purpose, and method of checking limit devices on load hoist and boom hoist
- (iii) Use of boom-angle indicator and safe-load charts

**DEPARTMENT OF
ENERGY
HOISTING & RIGGING
MANUAL**

TITLE: OPERATOR TRAINING AND QUALIFICATIONS

NUMBER: 2.0

REV: 00/91

- (iv) A knowledge and application of outriggers, unlevel ground, prepositioning for lifting
- (v) Knowledge of hazard and precautions when operating near overhead electrical power transmission lines
- (vi) Rigging, special problems, and risks for road travel with and without boom
- (vii) Positioning and anchoring for windstorms

(2) Forklift Truck Operators

Basic training for Forklift Truck Operators includes:

- (a) Activating and securing electrically powered trucks
- (b) Activating and securing internal-combustion-engine-powered trucks
- (c) Using an exhaust-emission-device and safety equipment
- (d) Basic handling of loads for stacking, traveling, or maneuvering
- (e) Operating over ramps
- (f) Using forklifts in trucks, semitrailer-tractor, and semitrailers without tractor
- (g) Using fork extensions and special attachments
- (h) Determining load limits, effect of load and highlift effect of load center of gravity, and irregular working surfaces
- (i) Learning the operation risk in hazardous areas, such as Flammable Liquids or Combustible Dusts

(3) Powered Industrial Truck Operators

Basic training for In-Plant Powered Industrial Truck Operators includes:

- (a) Activating and securing in-plant powered industrial trucks
- (b) Controlling exhaust-emission, idling, etc.
- (c) Positioning and securing loads
- (d) Operating in general and close-quarter areas
- (e) Carrying passengers
- (f) Pulling trailers

DRAFT

2.2 Person-In-Charge (PIC)

When handling High-Consequence material, the PIC is appointed to direct the lift. Material handling that is critical to operations may require designation of a PIC to supervise handling. When the item is large, expensive, irregular in shape, the center of gravity is difficult to determine, and the risk is high, a special person is designated as PIC. An equipment-operator foreman is usually the assistant. The special person designated PIC may be: (1) a high-level supervisor familiar with the High-Consequence material-handling operations; (2) an engineer with special knowledge of the material; or (3) a person with special knowledge of the equipment and handling necessary. A competent PIC should have training to assure capability for:

- 2.2.1 Organizing and handling pre-job planning.
- 2.2.2 Supervising pre-job organization and procedure meetings.
- 2.2.3 Meeting the requirements for tests of equipment, slings, tackle, etc., for proper certification and documentation.

2.3 Qualified Rigger Training

Rigging of loads shall be performed only by Qualified Riggers or Qualified Rigging Specialists. The use of the word "Rigger" is not intended to indicate a job classification; therefore, the heading and use here is a generic one (Section 1.0). The title and training requirements apply to any employee who performs rigging functions.

2.3.1 Qualified Riggers

- a. Qualified Riggers shall meet the following requirements:
 - (1) Age—Be at least 18 years.
 - (2) Language—Understand spoken and written English or a language in use at the location.
 - (3) Knowledge—Have basic knowledge and understanding of equipment-operating characteristics, capabilities, and limitations. Understand rigging principles as applied to the job for which they are to be qualified.
 - (4) Skill—Demonstrate skill in utilizing rigging principles.
- b. The initial qualification of Qualified Riggers shall include:
 - (1) Training with the equipment for the job for which they are to be qualified, under the direction of a Qualified Rigger or Qualified Rigging Specialist designated by management.
 - (2) Reviewing the applicant's knowledge, including written and oral examinations, and witnessing of their skills by the instructor.
 - (3) Inserting a written record of training, competency, and authorization in the employee's training record (by his/her supervisor). This record shall include identification of the operations for which the individual qualified.

DEPARTMENT OF ENERGY HOISTING & RIGGING MANUAL	TITLE: OPERATOR TRAINING AND QUALIFICATIONS
	NUMBER: 2.0 REV: 00/91

- c. Rigger qualification is for a period of three years, unless the qualification is revoked sooner by the rigger's manager. If riggers are disqualified, their manager shall enter the action in their file.
- d. The program for the maintenance of qualification of Qualified Riggers shall include:
 - (1) Verification by the riggers' manager that the individuals are required to do the rigging in the performance of their duties, and that they have been doing so safely and competently.
 - (2) Participation by the Qualified Rigger in an approved training program that includes the items in Section 2.3.2c.

2.3.2 Qualified Rigger Training Programs

- a. All organizations that employ personnel who do any rigging shall develop training programs, including means of testing, to assure that the personnel are competent to perform the operations. The Safety organization shall review program content for safety significance and include in their routine audits the administration of and compliance with the training and qualification program established and approved by the cognizant manager.
- b. The training program includes, but is not limited to:
 - (1) The use of rope, shackles, hooks, wire rope, chain and fabric slings, timbers, hoisting principles, rollers, scaffolds, weight estimation, center of gravity, factors of safety, and the effect of angular pulls in load lifting
 - (2) Safe attachment of slings for straight lifts, basket hitches, chokers, and multiple-bridle lifting
 - (3) Safe and unsafe placement of sling hooks
 - (4) Hook safety latches and hook mousing for safety
 - (5) Load-sling adjustments to keep the center of gravity in line of hook pull
 - (6) Risks and precautions when rigging near overhead power transmission lines
 - (7) Use of spreader bars for lifts and adjustment to keep the center of gravity in correct alignment for balanced lifts
 - (8) Testing and inspecting rigging equipment in accordance with this Manual

DEPARTMENT OF ENERGY HOISTING & RIGGING MANUAL	TITLE: OPERATOR TRAINING AND QUALIFICATIONS
	NUMBER: 2.0 REV: 00/91

2.4 Physical Requirements

2.4.1 General

Personnel assigned to operate equipment and rig for safe handling of material should be considered for physical capability on two separate bases. They are: (1) permanent physical conditions that apply to newly assigned employees and continuing assignment of employees already in this classification; and (2) temporary physical circumstances that restrict or modify the scope of an employee's assignment in these work situations.

- a. The employee shall not have a detectable or known disease or physical malfunction that would render the employee incapable of safe operation or rigging duties. Where any loss or loss of function of an upper or lower extremity exists, the acceptability of the candidate shall be the decision of the supervisor, after consulting with the designated physician.
- b. Qualified Operators and operator trainees should have normal depth perception, field of vision, reaction time, manual dexterity and coordination.

2.4.2 Full Time Operators:

Operators whose principal assignment is the operation of the equipment covered in this manual shall meet the following physical qualifications.

- a. Any Operator who has qualified under the requirements of 49 CFR 391.41 shall be deemed to have satisfied all requirements through Paragraph g. of this section.
- b. Have vision of at least 20/30 Snellen in one eye, and 20/50 in the other, with or without corrective lenses.
- c. Be able to distinguish colors, regardless of position of colors, if color differential is required for operation.
- d. Hearing, with or without hearing aid, must be adequate for a specific operation.
- e. Have sufficient strength, endurance, agility, coordination, and speed of reaction to meet the demands of equipment operation.
- f. Evidence of physical defects, or emotional instability which could render the operator a hazard to himself/herself or others, or which in the opinion of the examiner could interfere with the operator's safe performance may be sufficient cause for disqualification. In such cases, specialized clinical or medical judgments and tests may be required (Section 2.4.1).
- g. Evidence that an operator is subject to seizures or loss of physical control shall be sufficient reason for disqualification. Specialized medical tests may be required to determine these conditions.
- h. Special consideration must be given to cases where operators are required to climb up and down vertical ladders, circa 18.3 m (60 ft), in a reasonable length of time. This is particularly important where the ladders may be the means of egress in emergency situations.

DEPARTMENT OF ENERGY HOISTING & RIGGING MANUAL	TITLE: OPERATOR TRAINING AND QUALIFICATIONS
	NUMBER: 2.0 REV: 00/91

2.5 Qualification Examinations (Suggested Scope)

2.5.1 General Written Examinations:

The Supervisor is responsible for determining the operating ability, knowledge, and skill of the employees who are assigned operating or rigging duties. Generally, the written examination should apply specifically to the equipment for which the operator is qualifying. It should emphasize safe-operating practices and items of knowledge not readily apparent in operating ability testing. The written exam should contain not more than one-third of the questions of any one type, i.e., True-False, Multiple Choice, Completion of Blank, and Problem Solving.

Examinations may be scaled to the level of competence required to accommodate the classifications in Section 2.1.2b and 2.3.2b.

The following is presented only as a guide to the nature and type of questions which are recommended.

Suggested examples of questions:

- a. True or False: Lifting by crane is permissible only when the load is directly below the upper sheave.
- b. Multiple Choice: When lifting a load by crane, the acceptable positioning of the crane is:
 - (1) 30% from a straight upward lift
 - (2) 15% from a straight upward lift
 - (3) Directly upward without angles
- c. True or False: When using a forklift to carry a load down a ramp, you should move the truck down back end first.
- d. Multiple Choice: Negotiation of a ramp with a loaded forklift truck requires:
 - (1) Tine elevation to change the center of gravity
 - (2) That you back the loaded rig up the ramp
 - (3) That you back the loaded rig down the ramp
- e. Completion of Blanks: Passengers may be hauled on an in-plant powered industrial truck only when safe ___ are provided for them.
- f. Completion of Blanks: Rigging a load with a multiple-leg sling should provide at least ___ degrees of angle between each leg of the sling and a horizontal line at the top of the load.
- g. Problem Solving: Given a 20,000 lb. load to be handled with a two-leg sling. Length of sling to lifting hook results in an angle of 50 degrees, sling to the top of the load. What is the safe working load requirement for each leg of this sling?

**DEPARTMENT OF
ENERGY
HOISTING & RIGGING
MANUAL****TITLE: OPERATOR TRAINING AND QUALIFICATIONS****NUMBER: 2.0****REV: 00/91**

- Sine 50 degrees = 0.766
- Cos 50 degrees = 0.6428
- TAN 50 degrees = 1.1918

h. **Problem Solving:** On a forklift truck with the load pivot located at the front axle, the counterbalance and truck weight center was 4 feet behind the front axle and was 3000 lbs, including the operator. The unit load forward of the axle was neutral (0) due to mast tilting. What weight loads can be handled on level surface when the load center of gravity is:

- (1) 2 feet in front of front axle?
- (2) 5 feet in front of front axle?

2.5.2 Purpose of Exam:

The intent of qualification examinations is to assure that the person examined has sufficient knowledge to conduct the operation safely and efficiently. To that end, these examinations are not to be used for any other purpose. Since these examinations must be confined to the information presented in classes, they will also serve as indicators as to the effectiveness of the teaching. They are not intended to be pass-fail examinations, but shall be considered to be teaching aids.

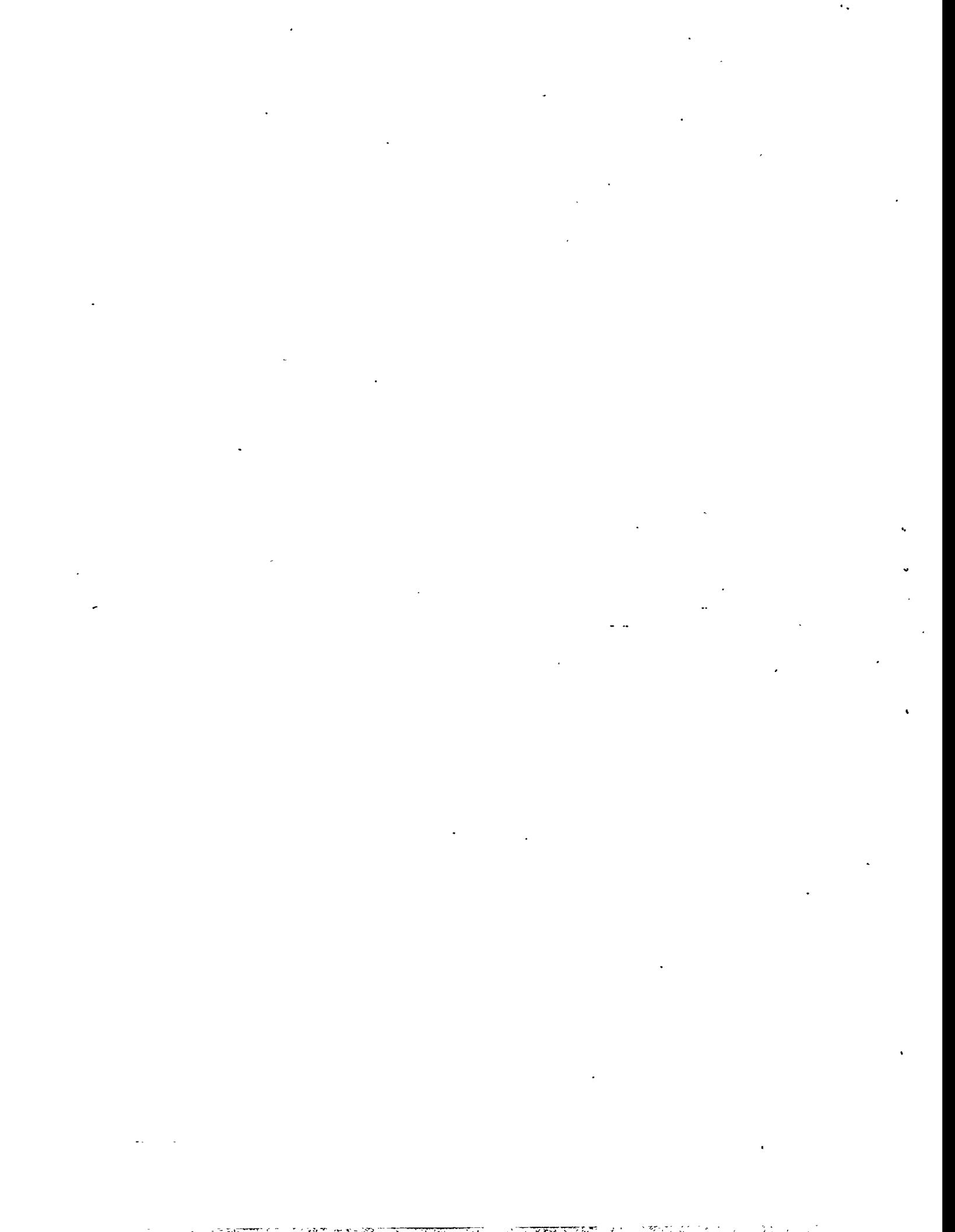

**DEPARTMENT OF
ENERGY
HOISTING & RIGGING
MANUAL**

TITLE: OVERHEAD & GANTRY CRANES

NUMBER: 3.0

REV: 00/91

CONTENTS

3.1	General	3-1
3.2	Operator Training/Qualification	3-1
3.3	Rated Load Marking	3-1
3.4	Modification	3-1
3.5	Egress	3-1
3.6	Brakes for Hoists	3-1
3.7	Power Shutoff	3-6
3.8	Hoist-Limit Switch	3-6
3.9	Load Limits	3-6
3.9.1	Load Weight	3-6
3.9.2	Planned Engineered Lifts	3-6
3.10	Maintenance History	3-7
3.11	Design Standards	3-7
3.12	Quality Assurance	3-8
3.13	Inspections	3-8
3.13.1	General	3-8
3.13.2	Ordinary Lifts	3-8
3.13.3	High-Consequence Lifts	3-12
3.13.4	Special-High-Consequence Lifts	3-12
3.14	Testing	3-12
3.14.1	Ordinary Lifts	3-12
3.14.2	High-Consequence Lifts	3-13
3.14.3	Special-High-Consequence Lifts	3-14
3.15	Operating Practices	3-14

DRAFT

DEPARTMENT OF ENERGY HOISTING & RIGGING MANUAL	TITLE: OVERHEAD & GANTRY CRANES	
	NUMBER: 3.0	REV: 00/91

3.15.1	General	3-14
3.15.2	Hoist-Limit Switch	3-15
3.15.3	Standard Signals	3-16
3.15.4	Identification of Signalers	3-16
3.15.5	Size of Load	3-16
3.15.6	Attaching the Load	3-16
3.15.7	Moving the Load	3-16
3.15.8	Lifting Personnel	3-18
3.15.9	Ordinary Lifts	3-20
3.15.10	High-Consequence Lifts	3-21
3.15.11	Special-High-Consequence Lifts	3-21

FIGURES

3-1	Top-running single or multiple girder bridge with top-running trolley hoist	3-2
3-2	Top-running single girder bridge with underhung trolley hoist	3-3
3-3	Monorails and underhung cranes	3-4
3-4	Jib cranes	3-5
3-5	Standard hand signals for controlling overhead crane operation	3-17

EXHIBITS

I	Periodic bridge, wall, gantry load test and inspection	3-23
---	--	------

DEPARTMENT OF ENERGY HOISTING & RIGGING MANUAL	TITLE: OVERHEAD & GANTRY CRANES
	NUMBER: 3.0 REV: 00/91

ISSUE NO.

3.0 OVERHEAD & GANTRY CRANES

3.1 GENERAL:

Overhead and gantry cranes include top-running single or multiple girder bridge with top-running trolley hoist (Figure 3-1), top-running single girder bridge with underhung trolley hoist (Figure 3-2), monorails and underhung cranes (Figure 3-3), and jib cranes (Figure 3-4).

Only equipment which has been built to the appropriate design standards (see Section 10) shall be used in DOE installations. Existing equipment shall be examined and the appropriate level of management shall determine to what extent the equipment will be brought into compliance.

This section specifies operation, inspection, maintenance and testing requirements for the use of overhead cranes and implements the requirements of ANSI/ASME B30.2, B30.11, and B30.17.

3.2 OPERATOR TRAINING/QUALIFICATION:

Operators of overhead cranes shall be trained and qualified as required in Section 2.0, "Operator Training and Qualification."

3.3 RATED-LOAD MARKING:

The special-rated capacity of the crane shall be plainly marked on each side of the crane. Each hoist shall have its special-rated capacity marked on its hoist block. This marking shall be clearly legible from the ground or floor.

3.4 MODIFICATION:

Cranes may be modified or rerated provided such modifications or supporting structures are analyzed thoroughly by a qualified engineer or manufacturer of cranes. Such action must be approved by the cognizant Safety organization. A rerated crane, or one whose load-supporting components have been modified, shall be tested in accordance with 3.14.1. The new special-rated capacity shall be displayed in accordance with 3.3, above.

3.5 EGRESS:

There shall be at least two means of egress from the crane, remote from each other, on cab-operated cranes, and so arranged as to permit departure under emergency conditions. The details of the means of egress shall depend upon the facts of the situation.

3.6 BRAKES FOR HOISTS:

3.6.1 Each independent hoisting unit shall be equipped with at least one holding brake, applied directly to the motor shaft or some part of the gear train.

3.6.2 Each independent hoisting unit (except worm-gear hoists; the angle of whose worm is such as to prevent the load from accelerating in the lowering direction) shall, in addition to a holding brake, be equipped with a controlled-braking means to control lowering speed.

DRAFT

DEPARTMENT OF
ENERGY
HOISTING & RIGGING
MANUAL

TITLE: OVERHEAD & GANTRY CRANES

NUMBER: 3.0

REV: 00/91

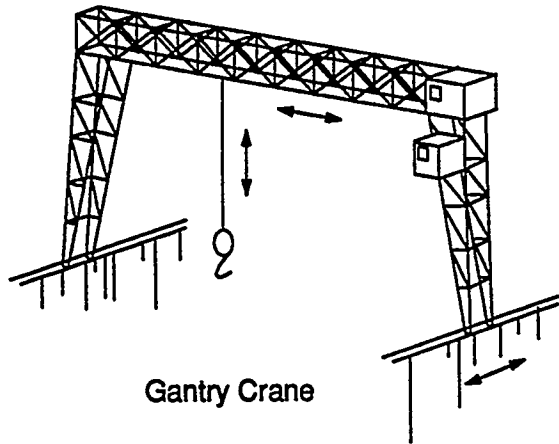

Gantry Crane

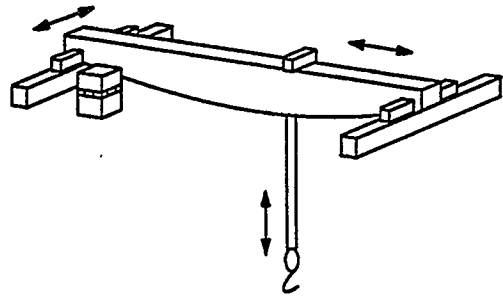

Overhead Traveling Crane

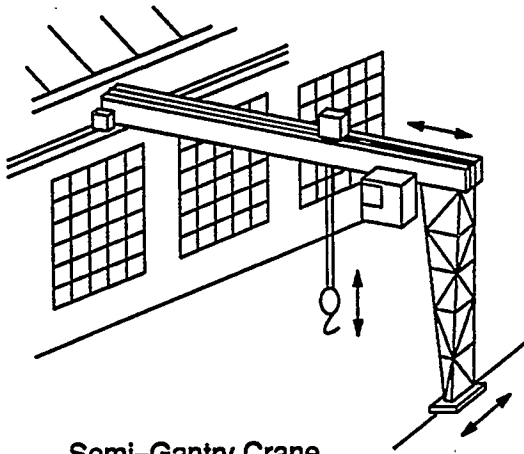

Semi-Gantry Crane

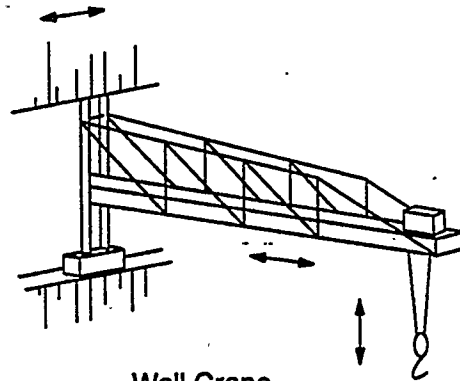

Wall Crane

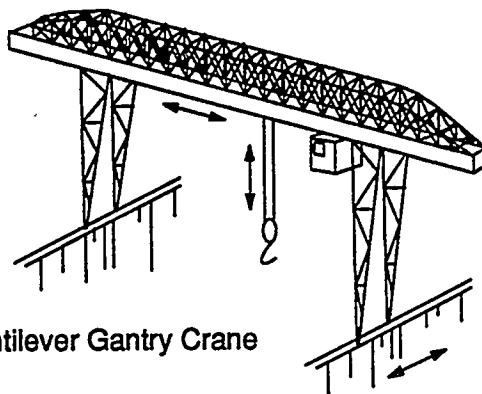

Cantilever Gantry Crane

LF91 0296

Figure 3-1. Top-running single- or multiple-girder bridge with top-running trolley hoist.

DRAFT

DEPARTMENT OF ENERGY HOISTING & RIGGING MANUAL	TITLE: OVERHEAD & GANTRY CRANES
	NUMBER: 3.0 REV: 00/91

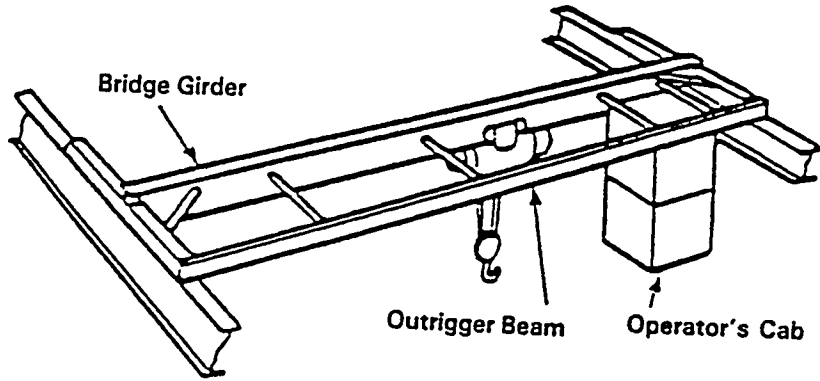

Overhead Cab-Operated Crane

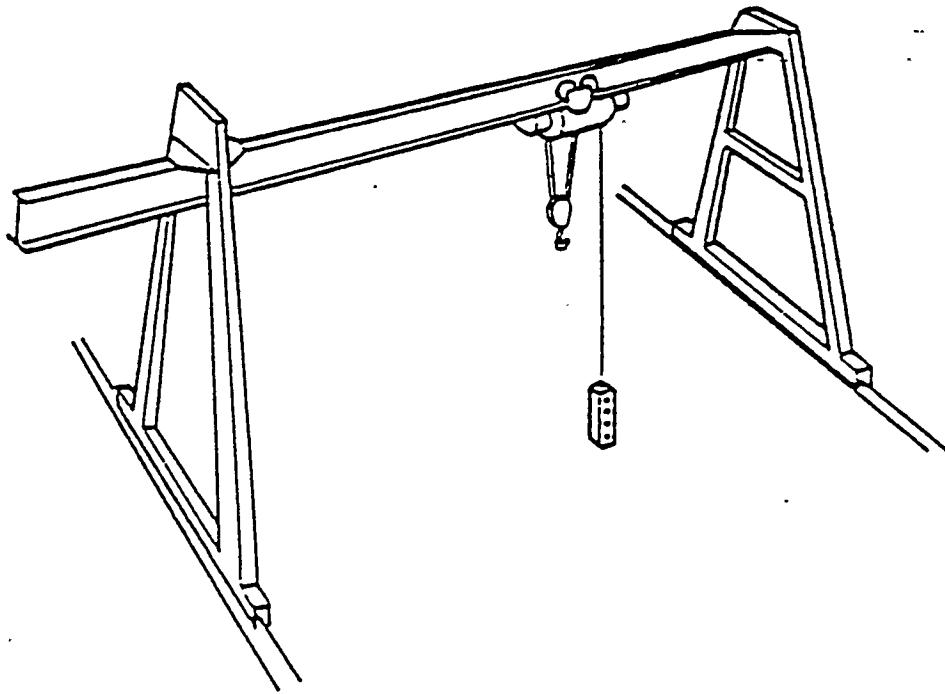

Cantilever Gantry Crane

Figure 3-2. Top-running single-girder bridge with underhung trolley hoist.

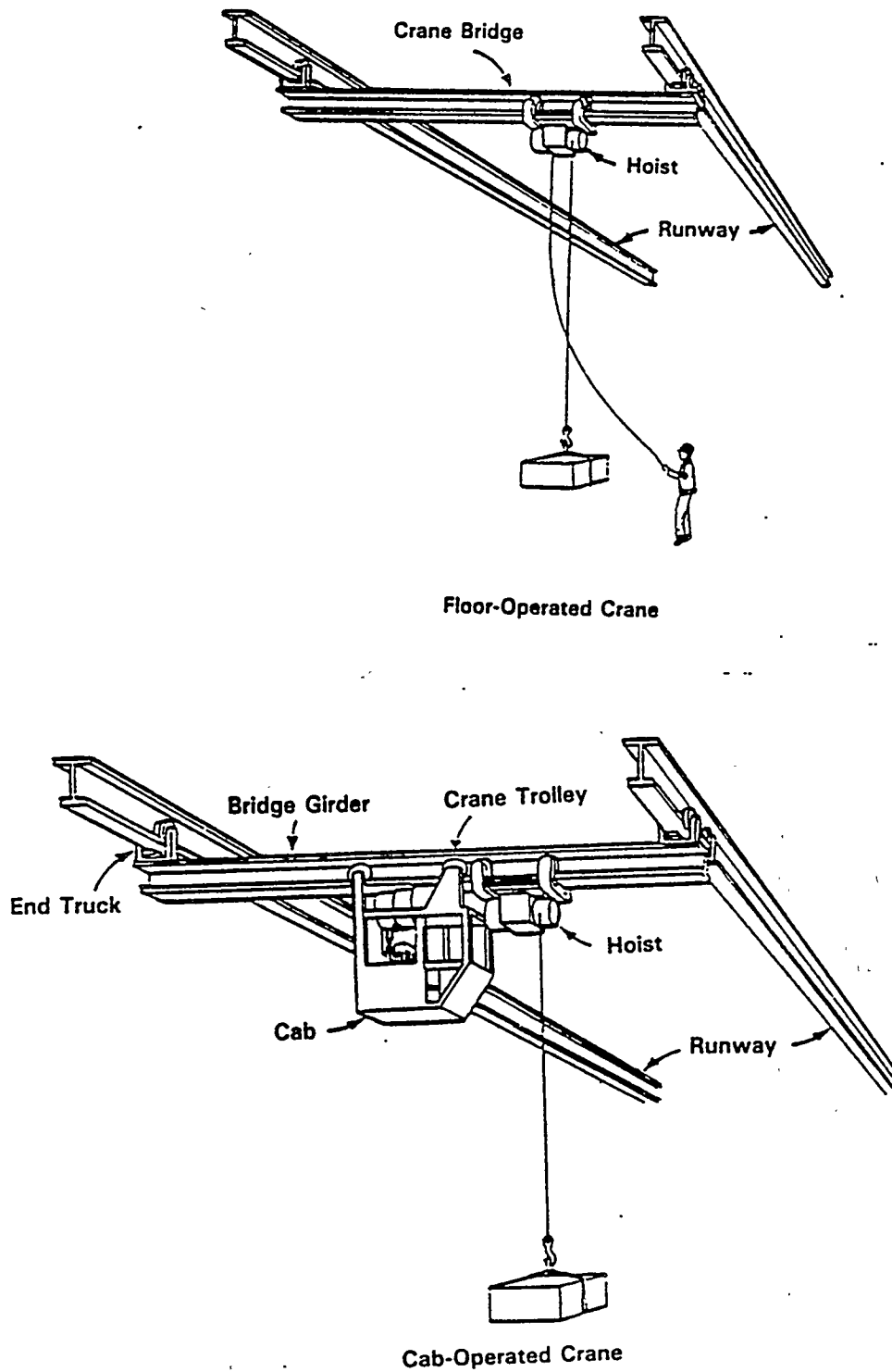
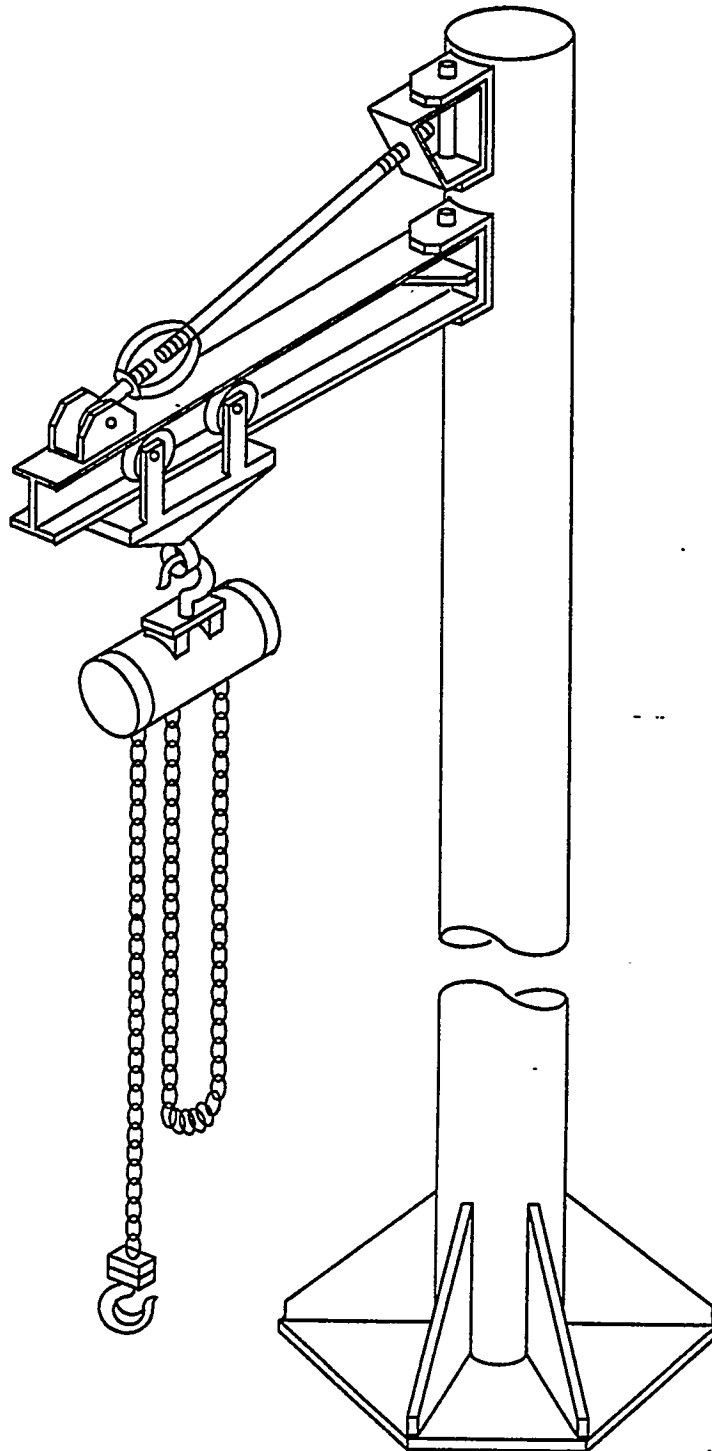

Figure 3-3. Monorails and underhung cranes.

DEPARTMENT OF ENERGY HOISTING & RIGGING MANUAL	TITLE: OVERHEAD & GANTRY CRANES NUMBER: 3.0 REV: 00/91
---	---



LF91 0299

Figure 3-4. Jib crane.

DRAFT

DEPARTMENT OF ENERGY HOISTING & RIGGING MANUAL	TITLE: OVERHEAD & GANTRY CRANES NUMBER: 3.0 REV: 00/91
---	---

3.6.3 Holding brakes on hoists shall be applied automatically when power is removed.

3.7 POWER SHUTOFF:

3.7.1 The power supply to the runway conductors shall be controlled by a switch or circuit-breaker located on a fixed structure, accessible from the floor, and arranged to be locked in the OPEN position.

3.7.2 On cab-operated cranes, a switch or circuit-breaker of the enclosed type with provisions for locking in the OPEN position, shall be provided in the leads from the runway conductors. A means of opening this device shall be located within the reach of the operator when the operator is in the operating position. When the operator opens this switch or circuit-breaker, the holding brake(s) should set.

3.7.3 On floor, remote, or pulpit-operated cranes, a device of the enclosed type shall be provided in the leads from the runway conductors. This device shall be mounted on the bridge or footwalk near the runway collectors. There shall be provisions for locking the device in the OPEN position unless the crane is the only load on a lockable switch or circuit-breaker that is accessible from the floor. One of the following types of floor, remote, and pulpit-operated disconnects shall be provided.

- a. A nonconductive rope attached to the main disconnect device on a floor-operated crane. If this is selected, the rope shall be suspended adjacent to the operating ropes if manual controllers are used, or near the pendant push-button station if magnetic controls are used.
- b. An under-voltage trip for a main circuit-breaker, operated by an emergency stop button in the pendant push-button station or the pulpit.
- c. A main-line contactor operated by a switch or push button on the pendant push-button station, the remote control station, or the pulpit.

3.8 HOIST-LIMIT SWITCH:

3.8.1 The hoisting motion of all cranes shall be provided with an overtravel-limit switch in the hoisting direction to stop the hoisting motion.

3.8.2 Lower-travel limit switches should be provided for all hoists where the load block enters pits or hatchways in the floor.

3.9 LOAD LIMITS:

3.9.1 *Load Weight*—The crane shall not be loaded beyond its special-rated capacity except for test purposes as provided in Section 3.14 or for Special Heavy Lifts as provided in 3.9.2.

3.9.2 *Planned Engineered Lifts*—Lifts in excess of the special-rated capacity may be required from time to time for special purposes, i.e., new construction, major repairs, etc. Every instance of exceeding the special-rated capacity shall be treated as a special problem, and the requirements listed below shall be met for each instance. Each instance must be reviewed by the cognizant Safety organization.

- a. The maintenance history of the crane, including reports of any prior Planned Engineered Lifts, shall be reviewed.

DEPARTMENT OF ENERGY HOISTING & RIGGING MANUAL	TITLE: OVERHEAD & GANTRY CRANES
	NUMBER: 3.0 REV: 00/91

- b. Structural, mechanical, and electrical components of the crane design shall be checked by a crane manufacturer, or other qualified person, for compliance with the requirements of ANSI/ASME NOG-1.
- c. The crane-supporting structure design shall be checked for conformance to AISC or other applicable design standard. A complete inspection of the crane, as described in 3.13.3, shall be made just prior to making the lift. The crane support shall be inspected and any deterioration or damage shall be taken into consideration in design calculations.
- d. Lifts shall be made under controlled conditions under the direction of an appointed person. In addition to the requirements listed under 3.15.7 of this Section, all personnel in the area of the crane runway shall be alerted.
- e. When Planned Engineered lifts are made, the load shall not exceed 125% of the crane load rating.
- f. Frequency of planned engineered lifts shall be limited to two such lifts during a continuous 12-month period. If such lifts are required on a more frequent basis, the crane shall be rerated or replaced with a crane having a load rating adequate for the load being handled.
- g. The operator shall test the crane for this special lift by lifting the load a short distance and setting brakes.
- h. Complete records of the lift, including all distances moved, shall be placed on file and shall be available to personnel.
- i. After the Planned Engineered Lift is concluded, a thorough inspection shall be made of all critical parts of the crane.
- j. The rated-load test that is specified in 3.14.1.b of this Manual is not applicable to Planned Engineered lifts.

3.10 MAINTENANCE HISTORY:

The maintenance history of the crane, including reports of any Planned Engineered Lifts, shall be retained throughout the service life of the crane.

3.11 DESIGN STANDARDS:

- 3.11.1** Structural, mechanical, and electrical components of the crane design shall meet the crane design standards called out in ANSI/ASME NOG-1.
- 3.11.2** The crane support structure shall conform to the AISC Standard listed in Section 10.0 of this Manual.
- 3.11.3** The safety features and operation shall conform, as a minimum, to the provisions of ANSI /ASME B30.2 (See Section 10.0).
- 3.11.4** Retrofit and extensively repaired cranes shall be subjected to an analysis of the electrical, mechanical, and structural systems. The objective of this analysis is to determine if appropriate preventive design measures have been taken to preclude failure in any mode or, at least, to minimize the probability of failure if the effect of such a failure would be significant. Once these analyses have been made by competent persons, the results shall be discussed with the cognizant safety organization and other organizations concerned, and decisions shall be made on the acceptability of the residual risks.

DEPARTMENT OF ENERGY HOISTING & RIGGING MANUAL	TITLE: OVERHEAD & GANTRY CRANES NUMBER: 3.0 REV: 00/91
---	---

3.11.5 Cranes which are to handle High-Consequence or Special-High-Consequence Loads shall meet the Type 2 requirements of ANSI/ASME NOG-1. Where nuclear or radioactive materials are involved, the cranes shall meet the Type 1 requirements of ANSI/ASME, NOG-1.

3.12 QUALITY ASSURANCE:

Quality Assurance Programs for cranes which are to handle High-Consequence and Special-High-Consequence Lifts shall meet the requirements of ANSI/ASME NQA-1.

3.13 INSPECTIONS:

3.13.1 General

- a. Equipment shall operate with a smooth, regular motion without any hesitation, abnormal vibration, binding, gross shimmy, or irregularity. There shall be no apparent damage, excessive wear, or deformation of any part of the equipment. Brakes shall work satisfactorily and load brakes shall be able to hold any load up to at least 125% of the rated stable capacity of the equipment, without slipping or overheating. All safety devices, load indicators, controls, and other operating parts of the equipment shall be checked during each inspection and shall be in good working order. Any defects shall be corrected or repaired before the equipment is put into service. Parts found to be defective as a result of any inspection or nondestructive examination shall be replaced or repaired as directed by the cognizant line manager or his/her designated representative.
- b. If an inspection has not been completed by the end of the required period, the equipment shall be downrated as follows:
 - (1) Thirty calendar days after the end of the period, the equipment shall be downrated to 75% of the rated capacity.
 - (2) Sixty calendar days after the end of the period, the equipment shall be downrated to 50% of the rated capacity.
 - (3) Ninety calendar days after the end of the period, the equipment shall be taken out of service until the required inspection has been completed.

3.13.2 Ordinary Lifts

- a. Prior to initial use, all new, reinstalled, altered, modified, or extensively repaired cranes shall be inspected by a qualified inspector to assure compliance with the provisions of this Manual.
- b. Inspection procedures for cranes in regular service are divided into two general classifications, based upon the intervals at which inspection should be performed. The intervals, in turn, are dependent upon the nature of the critical components of the crane and the degree of their exposure to wear, deterioration, or malfunction. The two general classifications are herein designated as "frequent" and "periodic," with respective intervals between inspection as defined below:
 - (1) Frequent inspection: The operator, or a designated person, shall visually examine the crane (records not required except as noted) in accordance with the following schedule:
 - Normal service: monthly

DRAFT

**DEPARTMENT OF
ENERGY
HOISTING & RIGGING
MANUAL**

TITLE: OVERHEAD & GANTRY CRANES

NUMBER: 3.0

REV: 00/91

- 3.11.5** Cranes which are to handle High-Consequence or Special-High-Consequence Loads shall meet the Type 2 requirements of ANSI/ASME NOG-1. Where nuclear or radioactive materials are involved, the cranes shall meet the Type 1 requirements of ANSI/ASME, NOG-1.

3.12 QUALITY ASSURANCE:

Quality Assurance Programs for cranes which are to handle High-Consequence and Special-High-Consequence Lifts shall meet the requirements of ANSI/ASME NQA-1.

3.13 INSPECTIONS:

3.13.1 General

- a. Equipment shall operate with a smooth, regular motion without any hesitation, abnormal vibration, binding, gross shimmy, or irregularity. There shall be no apparent damage, excessive wear, or deformation of any part of the equipment. Brakes shall work satisfactorily and load brakes shall be able to hold any load up to at least 125% of the rated stable capacity of the equipment, without slipping or overheating. All safety devices, load indicators, controls, and other operating parts of the equipment shall be checked during each inspection and shall be in good working order. Any defects shall be corrected or repaired before the equipment is put into service. Parts found to be defective as a result of any inspection or nondestructive examination shall be replaced or repaired as directed by the cognizant line manager or his/her designated representative.
- b. If an inspection has not been completed by the end of the required period, the equipment shall be downrated as follows:
 - (1) Thirty calendar days after the end of the period, the equipment shall be downrated to 75% of the rated capacity.
 - (2) Sixty calendar days after the end of the period, the equipment shall be downrated to 50% of the rated capacity.
 - (3) Ninety calendar days after the end of the period, the equipment shall be taken out of service until the required inspection has been completed.

3.13.2 Ordinary Lifts

- a. Prior to initial use, all new, reinstalled, altered, modified, or extensively repaired cranes shall be inspected by a qualified inspector to assure compliance with the provisions of this Manual.
- b. Inspection procedures for cranes in regular service are divided into two general classifications, based upon the intervals at which inspection should be performed. The intervals, in turn, are dependent upon the nature of the critical components of the crane and the degree of their exposure to wear, deterioration, or malfunction. The two general classifications are herein designated as "frequent" and "periodic," with respective intervals between inspection as defined below:
 - (1) Frequent inspection: The operator, or a designated person, shall visually examine the crane (records not required except as noted) in accordance with the following schedule:
 - Normal service: monthly

DRAFT

DEPARTMENT OF ENERGY HOISTING & RIGGING MANUAL	TITLE: OVERHEAD & GANTRY CRANES NUMBER: 3.0 REV: 00/91
---	---

only as much of the rope as is necessary to visually examine at least those portions that are flexed in passing over sheaves, etc. and other areas subject to wear and abrasion. A major inspection of all ropes shall be made at least annually. This inspection shall include examination of the entire length of the rope, using 5X magnification in questionable areas. If cranes operate in a hostile environment, lift a high percentage of capacity loads, are subjected to shock loads, or have high-frequency rates of operation, interim rope inspection intervals should be established as determined by a qualified person. Sections of rope which are normally hidden during visual and maintenance inspection (e.g., parts passing over sheaves) should be given close inspection, as these are points most likely to fail. Any deterioration resulting in appreciable loss of original strength, such as described below, shall be carefully noted and a determination made as to whether further use of the rope would constitute an acceptable risk.

- (1) Reduction of rope diameter below nominal diameter due to loss of core support, internal or external corrosion, or wear of outside wires
 - (2) A number of broken outside wires and the degree of distribution or concentration of such broken wires
 - (3) Worn outside wires
 - (4) Corroded or broken wires at end connections
 - (5) Corroded, cracked, bent, worn, or improperly applied end connections
 - (6) Kinking, crushing, cutting or unstranding.
- e. All rope on cranes which have been idle for a period of six months or more, due to shutdown or storage of a hoist on which it is installed, shall be given an inspection in accordance with 3.13.2.c before it is placed in service. A dated and signed report of the rope inspection, including results, shall be filed.
- f. No precise rules can be given for determination of the exact time for replacement of rope, since many variables are involved. Continued use depends largely upon the use of good judgment by an appointed or authorized person in evaluating the remaining strength in a used rope, after allowance for deterioration disclosed by inspection. Continued operation depends upon this remaining strength.
- g. Conditions, such as the following, shall be sufficient reason for questioning continued use of the rope or increasing the frequency of inspection:
- (1) In running ropes, 12 randomly distributed broken wires in one rope lay, or 3 broken wires in one strand in one rope lay
 - (2) Wear of one-third the original diameter of outside individual wires
 - (3) Kinking, crushing, birdcaging, or any other damage resulting in distortion of the rope structure
 - (4) Evidence of heat damage
 - (5) Reduction from nominal diameter greater than those listed in the following:

**DEPARTMENT OF
ENERGY
HOISTING & RIGGING
MANUAL**

TITLE: OVERHEAD & GANTRY CRANES

NUMBER: 3.0

REV: 00/91

Rope Diameter	Maximum Allowable Reduction From Nominal Diameter
Up to 5/16 in. (8 mm)	1/64 in. (0.4 mm)
Over 5/16 in. to 1/2 in. (13 mm)	1/32 in. (0.8 mm)
Over 1/2 in. to 3/4 in. (19 mm)	3/64 in. (1.2 mm)
Over 3/4 in. to 1 1/8 in. (29 mm)	1/16 in. (1.6 mm)
Over 1 1/8 in. to 1 1/2 in. (38 mm)	3/32 in. (2.4 mm)

- h. In order to establish data as a basis for judging the proper time for replacement, a continuing inspection record shall be maintained. This record shall cover points of deterioration listed in 3.13.2.G.

All replacement rope shall be of proper size, grade, and construction for the particular function it is to perform on the machine.

Discarded rope shall not be used for slings.

Periodic inspection shall include complete inspections of the crane, which shall be performed at intervals as generally defined in 3.13.2.b.(2). Any deficiencies such as those listed below, shall be carefully examined, and determinations made as to whether they constitute hazards. These inspections shall include the requirements of 3.13.2.b(1), and, in addition, items such as the following:

- (1) Deformed, cracked, or corroded members
- (2) Loose bolts or rivets
- (3) Cracked or worn sheaves and drums
- (4) Worn, cracked, or distorted parts such as pins, bearings, shafts, gears, rollers, locking, and clamping devices
- (5) Excessive wear on brake-system parts, linings, pawls, and ratchets
- (6) Load, wind, and other indicators over their full range for any significant inaccuracies
- (7) Gasoline, diesel, electric, or other power plants for improper performance or noncompliance with other applicable standards
- (8) Excessive wear of chain-drive sprockets, and excessive chain stretch
- (9) Electrical apparatus for signs of any deterioration of controllers, master switches, contacts, limit switches, and push-button stations, but not limited to these items.
- (10) Hooks damaged from chemicals, deformation, cracks, or having more than 15% in excess of normal throat operating, or more than 10-degree twist from the plane of the unbent hooks.

DRAFT

DEPARTMENT OF ENERGY HOISTING & RIGGING MANUAL	TITLE: OVERHEAD & GANTRY CRANES NUMBER: 3.0 REV: 00/91
---	---

- i. A crane, other than a standby crane, which has been idle for a period of one month or more but less than one year, shall be given an inspection conforming with the requirements of 3.13.2.b(1) before placing it in service.
- j. Standby cranes shall be inspected annually, in accordance with the requirements of 3.13.2.b(1). Standby cranes exposed to adverse environment shall be inspected more frequently.
- k. Nondestructive examination of hooks and when required, welds, bearings, or other suspect load-bearing parts shall be performed annually.
- l. Reports of all inspections shall be maintained. Records should include item identification, characteristics inspected, observations, disposition if any, and date of actions. Records shall be kept readily available for inspection by designated personnel.

3.13.3 High-Consequence Lifts

- a. All provisions of 3.13.2 shall apply.
- b. Equipment shall receive a major inspection when first assigned to this service and at 12-month intervals thereafter, if continuing use for High-Consequence Lifts is planned. Major inspection shall include all points and items covered by the equipment manufacturer's recommendations (when available).
- c. Nondestructive examination of hooks and, when required, welds, bearings, or other suspect load-bearing parts shall be done at specified intervals. NDE examinations shall be in accordance with pertinent sections of applicable ASTM Standards. Annual maintenance shall be carried out prior to or during the major inspection. Items for inspection are included in Exhibit I, "Periodic Bridge, Wall, Gantry Crane Load Test & Inspection," which appears at the end of this section.

3.13.4 Special-High-Consequence Lifts

All provisions of 3.13.3 shall apply.

3.14 TESTING:

3.14.1 Ordinary Lifts

- a. Prior to initial use, all new, extensively repaired, or altered cranes shall be tested and inspected by a qualified inspector. A written report shall be furnished by such person, confirming the load rating of the crane. The load rating shall not be more than 80% of the maximum load sustained during the test. Test loads shall not be more than 125% of the manufacturer's rated load, unless otherwise recommended by the manufacturer. The test reports shall be kept on file and readily available to appointed personnel.
- b. The rated load test for new cranes shall consist of the following operations as minimum requirements:
 - (1) Hoist the test load a sufficient distance to assure that the load is supported by the crane and held by the hoist brake(s).

DEPARTMENT OF ENERGY HOISTING & RIGGING MANUAL	TITLE: OVERHEAD & GANTRY CRANES NUMBER: 3.0 REV: 00/91
---	---

- (2) Transport the test load by means of the trolley for the full length of the bridge.
 - (3) Transport the test load by means of the bridge for the full length of the runway, in one direction with the trolley as close to the extreme right-hand end of the crane as practical, and in the other direction with the trolley as close to the extreme left-hand end of the crane as practical.
 - (4) Lower the test load, stopping by the brakes.
 - (5) The trip setting of hoist-limit devices shall be determined by tests, with an empty hook traveling in increasing speeds up to the maximum speed. The actuating mechanism of the limit device shall be located so that it will trip the device, under all conditions, in sufficient time to prevent contact of the hook or load block with any part of the trolley or crane.
- c. Extensively repaired or altered cranes shall be tested in accordance with b. above insofar as interfering equipment and structures permit. A minimum test shall consist of items (1), (4), and (5) in b. above.
 - d. Equipment shall be routinely load tested when assigned to this service, thereafter at three-year intervals, and when specified in the procedures. Written, dated and signed reports shall be kept on file and readily available to appointed personnel. Load tests shall be made in an area where no critical items or equipment for handling critical items are installed, being worked on, or stored. Before starting the load test, equipment shall be inspected in accordance with 3.13.2.b(2). Defective parts shall be replaced or repaired before starting the load test.
 - e. The load test in 3.14.1.d shall not exceed the rated capacity of the crane. Test weights shall be accurate to within -5%, +0% of stipulated values.
 - f. If a test has not been completed by the end of the required period, the equipment shall be downrated as follows:
 - (1) Thirty calendar days after the end of the period, the equipment shall be downrated to 75% of the rated capacity.
 - (2) Sixty calendar days after the end of the period, the equipment shall be downrated to 50% of the rated capacity.
 - (3) Ninety calendar days after the end of the period, the equipment shall be taken out of service until the required inspection has been completed.

3.14.2 High-Consequence Lifts

- a. All provisions of 3.14.1.a, b, c, and f shall apply.
- b. Equipment shall be load tested when assigned to this service, thereafter at 3 year intervals, and when specified in the procedures. Load tests shall be made in an area where no critical items or equipment for handling critical items are installed, being worked on, or stored. Before starting the load test, equipment shall be inspected in accordance with 3.13.2.b(2). Defective parts shall be replaced or repaired before starting the load test.

DEPARTMENT OF ENERGY HOISTING & RIGGING MANUAL	TITLE: OVERHEAD & GANTRY CRANES NUMBER: 3.0 REV: 00/91
---	---

- c. Routine load tests may be made with a hook load equal to 125% of the manufacturer's-rated capacity of the crane. Prolift load tests are not mandatory but if specified in the procedures, shall be made with a hook load of 125% of the combined weight of the item to be lifted and the lifting tackle, or with a hook load of 125% of the manufacturer's-rated capacity. In no case shall the load test exceed the 125% of manufacturer's-rated capacity of the equipment. Test weights shall be accurate to within -5%, +0% of stipulated values. Test results shall be recorded.
- (1) The test loads required in 3.14.2.b and c should be structured, by administrative control, to 125% of the maximum operational load anticipated in the following six-month period, rather than routinely at 125% of the manufacturer's-rated capacity.
 - (2) Static Test: Equipment shall hold the test load for 10 minutes, or the time required to check all primary load-bearing parts while under strain without slippage, damage, or permanent deformation of any part of the equipment. Hoisting equipment and winches shall be tested at maximum run-out of the hoisting ropes or chain, insofar as practical.
 - (3) Dynamic Test: Hoisting equipment shall be operated through at least two complete cycles of all movements which the equipment will encounter in service, while supporting the test load. As a minimum, the test load shall be raised far enough for all drums, sheaves, gears, or other rotating parts of the hoisting mechanism to complete at least one or, if possible in the clearance available, two complete revolutions; then lowered until the load comes within 2 or 3 inches of the floor; and held at this level for one minute. The hoisting cycle shall be repeated at least one more time. Tests shall be made by the operator who normally operates the equipment, who shall demonstrate his/her ability to positively control the load during all lateral, rotational, and vertical motions which will be encountered in service. At least once during the lifting portion of the hoisting cycle, and once during the lowering cycle, power to the hoisting equipment shall be completely turned off. There shall be no slippage of the load or overheating of the brakes.

3.14.3 Special-High-Consequence Lifts

- a. All provisions of 3.14.2 shall apply.
- b. Equipment shall be load tested when assigned to this service, thereafter at 3 year intervals, and when specified in the procedures. Load tests shall be made in an area where no critical items or equipment for handling critical items are installed, being worked on, or stored. Before starting the load test, equipment shall be inspected in accordance with 3.13.2.b(2). Defective parts shall be replaced or repaired before starting the load test.

3.15 OPERATING PRACTICES:

3.15.1 General

- a. An appointed person shall classify each lift into one of the DOE categories before the lift is planned.
- b. The operator shall not engage in any practice which will divert his/her attention while actually engaged in operating the crane.
- c. The operator shall not operate this equipment when he/she is physically or mentally incapacitated. The immediate supervisor shall participate in this determination.

DRAFT

DEPARTMENT OF ENERGY HOISTING & RIGGING MANUAL	TITLE: OVERHEAD & GANTRY CRANES
	NUMBER: 3.0 REV: 00/91

- d. Each operator shall be held directly responsible for the safe operation of his/her equipment. Whenever there is any question as to the safety of the activity, the operator shall have the authority to stop and refuse to handle loads until the matter has been resolved by supervision.
- e. If a warning signal is furnished, it shall be sounded during travel, particularly when approaching personnel.
- f. If the operator finds the main or emergency switch open when starting on duty, he/she shall not close it until he/she has made certain that no one is on or about the crane. If there is a warning sign on the switch, the operator shall not remove it, unless he/she placed it there, and he/she shall not close the switch until the warning sign has been removed by the person who placed it there.
- g. Before closing the main switch, the operator shall see to it that all controllers are in the OFF position.
- h. If a power failure occurs during operation, the operator shall immediately switch all controllers to the OFF position.
- i. The operator shall become familiar with his/her equipment and its proper care. If adjustments or repairs are necessary, or any defects are known, the operator shall report the same promptly to the cognizant supervisor, and shall also notify the next operator of the defects, upon changing shifts.
- j. Contacts with runway stops or other cranes shall be made with extreme caution. If the operator is ordered to engage with or push other cranes, he/she shall do so with particular care for the safety of persons on or below the cranes, and only after making certain that any persons on the other cranes are aware of what he/she is doing.
- k. Operators of outdoor cranes shall secure them when leaving.
- l. When the wind-indicating alarm is given, the bridge on outside cranes shall be anchored.
- m. The main positive electrical control switch shall be locked and tagged in the OPEN position before any crane maintenance is performed.
- n. All controls shall be operated by the operator before beginning a new shift. If any controls do not operate properly, they shall be adjusted or repaired before operations are begun.
- o. Two or more separately rigged loads shall not be hoisted in one lift, even though the combined load is within the crane's rated capacity.
- p. A 10BC, or larger, fire extinguisher shall be installed in the cab of cab-operated cranes. The extinguisher shall be maintained in a serviceable condition.

3.15.2 Hoist-Limit Switch

- a. At the beginning of each work shift, or the first time the crane is used during that shift, the operator shall try out the upper-limit switch of each hoist under no load. Extreme care shall be exercised; the block shall be "inched" into the limit, or run in at slow speed. If the switch does not operate properly, the operator shall immediately notify his/her supervision.
- b. If a lift is in progress during a shift change, this testing requirement is considered to have been satisfied for the completion of that lift. However, the limit switch must be tested again before the next lift.

DEPARTMENT OF ENERGY HOISTING & RIGGING MANUAL	TITLE: OVERHEAD & GANTRY CRANES NUMBER: 3.0 REV: 00/91
---	---

- c. The final hoist-limit switch which controls the upper limit of travel of the load block shall not be used as an operating control.

3.15.3 Standard Signals

The standard signals for DOE use shall be as specified in the latest edition of the American National Standards Institute (ANSI) B30 chapters, for the particular type of crane or hoist being used. (See Figure 3-5.)

3.15.4 Identification of Signalers

- a. All personnel acting as signalers during crane operations shall be clearly identified to the crane operator by the use of the following (one or more, as required by the cognizant manager): orange hardhat; orange gloves; and/or orange vest. This requirement may be waived by the cognizant manager when the lift is very closely controlled and personnel are required to wear special clothing for protection from a hazardous environment.
- b. In those cases where the crane operator cannot see the signaler, a second person (relay signaler) shall be stationed where he/she can see both the signaler and the crane operator and relay the signals to the operator. The relay signaler shall also be clearly identified by the items in 3.15.4.a., above.
- c. Where voice (direct or two-way radio) communication is used, the signaler shall communicate directly with the operator; not through a third person.
- d. The operator shall recognize signals only from the designated signaler, except that a signal for a stop shall be obeyed when given by anyone.

3.15.5 Size of Load

The crane shall not be loaded beyond its special-rated capacity, except as may be provided in Section 3.9.

3.15.6 Attaching the Load

- a. The hoist rope shall be free from kinks or twists and shall not be wrapped around the load.
- b. The load shall be attached to the load-block hook by means of slings or other approved devices.
- c. Care shall be taken to make certain that the sling clears all obstacles.

3.15.7 Moving the Load





- a. The appointed person directing the lift shall see that the load is well secured and properly balanced in the sling or lifting device before it is lifted more than a few inches.
- b. Before starting to hoist, note the following conditions:
- (1) Hoist rope shall not be kinked.
 - (2) Multiple-part lines shall not be twisted around each other.
 - (3) The hook shall be brought over the load in such a manner as to prevent swinging.

**DEPARTMENT OF
ENERGY
HOISTING & RIGGING
MANUAL**

TITLE: OVERHEAD & GANTRY CRANES

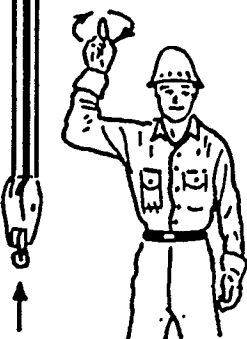
NUMBER: 3.0

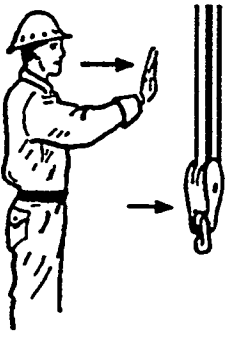
REV: 00/91

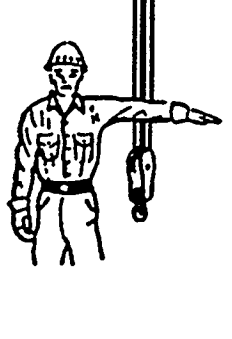
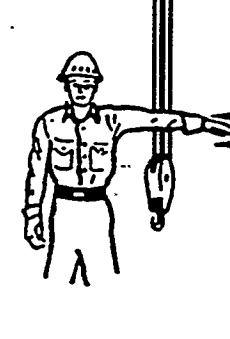
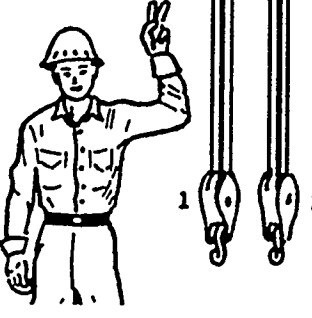
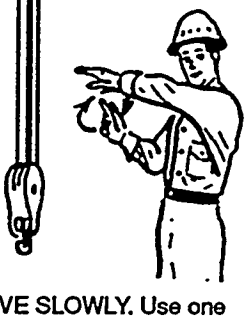
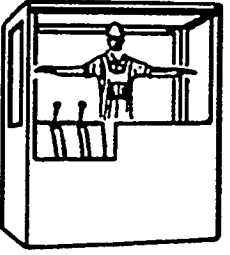
 <p>HOIST. With forearm vertical, forefinger pointing up, move hand in small horizontal circles.</p>	 <p>LOWER. With arm extended downward, forefinger pointing down, move hand in small horizontal circles.</p>	 <p>BRIDGE. Arm extended forward, hand open and slightly raised, make pushing motion in direction of travel.</p>
 <p>TROLLY TRAVEL. Palm up, finger closed, thumb pointing in direction of motion, jerk hand horizontally.</p>	 <p>STOP. Arm extended, palm down, hold position rigidly.</p>	 <p>EMERGENCY STOP. Arm extended, palm down, move hand rapidly right and left.</p>
 <p>MULTIPLE TROLLEYS. Hold up one finger for block marked "1" and two fingers for block marked "2". regular signals follow.</p>	 <p>MOVE SLOWLY. Use one hand to give any motion signal and place other hand motionless in front of hand giving the motion signal. (Hoist Slowly shown as example)</p>	 <p>MAGNET IS DISCONNECTED. Crane operator spreads both hands apart palms up.</p>

LF90-0124

Figure 3-5. Standard hand signals for controlling overhead crane operator.

DEPARTMENT OF ENERGY HOISTING & RIGGING MANUAL	TITLE: OVERHEAD & GANTRY CRANES NUMBER: 3.0 REV: 00/91
---	---

- (4) If there is a slack-rope condition, it should be determined that the rope is properly seated on the drum and in the sheaves.
- (5) The qualified rigger shall be clear of the load.
- c. During hoisting, care shall be taken that:
 - (1) There is no sudden acceleration or deceleration of the moving load.
 - (2) Load does not contact any obstructions. A "dry run" shall be conducted in areas where clearance is limited.
- d. Cranes shall not be used for side pulls except when specifically authorized by an appointed person who has determined that the stability of the crane is not endangered and that various parts of the crane will not be overstressed.
- e. The operator shall avoid carrying loads over people.
- f. The operator shall test the hoist brakes each time a load approaching the special-rated capacity is handled by raising the load a few inches and applying the brakes. Any down motion is unacceptable.
- g. The hook shall not be lowered below the point where less than two full wraps of rope remain on the hoisting drum.
- h. When the load or hook approaches near personnel, the warning signal shall be sounded.
- i. A tag line shall be used when it becomes necessary to guide, snub, or otherwise control the load.
- j. The operator shall land any attached load, place controls in the OFF position, and turn OFF the power source before leaving the crane unattended, unless required to do otherwise by an approved emergency procedure.
- k. Work on suspended loads is prohibited under normal conditions. Where the cognizant manager decides that it is necessary to work on a suspended load, safe guidelines shall be established through consultation with the appropriate safety organization. Suspended loads that must be worked on shall be secured against unwanted movement. Paragraph j., above is not affected by this paragraph.

3.15.8 Lifting Personnel

No lifting, lowering, swinging, or traveling shall be done while a worker is on the hook, load, or manlift platform attached to the crane load line except under the following conditions:

- a. A qualified person responsible for overall work-site safety shall determine that there is no practical, alternative way to perform the work, by using a ladder, scaffold, stairway, aerial lift or personnel hoist.
- b. Platforms shall be designed and constructed in accordance with the following:
 - (1) The personnel platform shall be designed by a qualified person competent in structural design and all welding of the platform shall be performed by a qualified welder familiar with the weld grades, types and material specified in the design.

DRAFT

DEPARTMENT OF ENERGY HOISTING & RIGGING MANUAL	TITLE: OVERHEAD & GANTRY CRANES NUMBER: 3.0 REV: 00/91
---	---

- (2) The platform shall be limited to a capacity of six persons and shall be used only for employees, tools and materials to do the work and shall not be used to hoist materials or tools when not hoisting personnel.
 - (3) The platform shall have a minimum design factor of 5.
 - (4) The platform shall have a plate specifying the weight of the empty platform and the maximum number of persons and weight for which the platform is rated.
 - (5) The platform shall have standard railing as required by OSHA 29 CFR 1926.500(f). A grab rail shall be installed inside the entire perimeter of the personnel platform.
 - (6) The sides of the platform shall be enclosed from the toeboards to the mid-rails with solid construction or expanded metal having openings no greater than 1/2 in. (1.27 cm).
 - (7) If access doors are installed, they shall open only to the interior of the platform. Access doors shall be equipped with a device to restrain the door from inadvertent opening.
 - (8) The platform shall have overhead protection when there is an overhead hazard and employees shall use a body belt/harness and lanyard attached to the lower load block or overhaul ball or to a structural member within the personnel platform capable of supporting a fall impact for employees using the anchorage.
 - (9) The platform shall be easily identifiable by high visibility color or marking.
 - (10) Headroom shall be provided which allows employees to stand upright in the platform.
 - (11) Rough edges exposed to contact by employees shall be surfaced to prevent injury to employees.
- c. The following procedures shall be followed:
- (1) Prior to hoisting personnel at each job site and after any repair or modification, the platform and rigging shall be proof tested by a qualified inspector to 125% of the platform's rated capacity by holding it in a suspended position for five minutes with the test load evenly distributed on the platform (this may be done concurrently with the trial lift). After proof testing, the platform and rigging shall be inspected by a certified inspector and any deficiencies found shall be corrected prior to repeating the proof test procedure.
 - (2) Prior to lifting personnel, the qualified operator and signal person shall conduct a trial lift with the manlift platform loaded to at least the anticipated liftweight. Materials and tools to be used during the actual lift shall be loaded in the platform. A single trial lift may be performed at one time for all locations that are to be reached from a single set up position. A visual inspection of the crane, rigging, and manlift platform shall be conducted by a certified inspector immediately after the trial lift prior to lifting personnel. Any defects found which create a safety hazard shall be corrected prior to hoisting personnel.
 - (3) The trial lift shall verify that all systems, controls, and safety devices are activated and functioning properly; that no interferences exist; and that all configurations necessary to reach those work locations will allow the operator to remain under the 50% limit of the crane's rated capacity.

DEPARTMENT OF ENERGY HOISTING & RIGGING MANUAL	TITLE: OVERHEAD & GANTRY CRANES NUMBER: 3.0 REV: 00/91
---	---

- (4) A meeting attended by the Qualified Operator, signalperson, persons to be lifted, and the person responsible for overall worksite safety shall be held prior to the trial lift to plan and review procedures to be followed. Procedures for entering and leaving the manlift platform or other device and the points at which persons will enter and leave the device shall be reviewed.
- (5) When being supported by a crane, the platform shall be attached to the hoist rope by a hook of a type that can be closed and locked, eliminating the hook throat opening. Alternatively, an alloy steel anchor shackle with a bolt, nut, and retaining pin may be used.
- (6) The total weight of the loaded personnel platform and related rigging shall not exceed 50% of the rated capacity for the configuration of the crane.
- (7) A signal person shall be used.
- (8) All eyes in wire rope slings shall be fabricated with thimbles; and all rigging accessories for attaching the personnel platform to hoist lines shall not be used for any other purpose when not hoisting personnel.
- (9) The employees being hoisted, moved, and/or positioned shall remain in continuous sight of, and in direct communication with, the operator or signalperson. In situations where direct visual contact with the operator is not possible and the use of a signalperson would create a greater hazard for that person, direct communication alone such as by radio may be used.
- (10) A positive activating device shall be installed to prevent two-blocking, or a system which deactivates the hoisting action before damage occurs in the event of a two-blocking situation (two block damage prevention feature).
- (11) When welding is done by an employee on the platform, welding-rod holders shall be protected from contact with metal components of the platform.
- (12) Employees working from a platform shall wear safety belts with lanyards attached, preferably above the hook or shackle, when suspended.
- (13) The Qualified Operator shall remain at the controls at all times when the platform is elevated.
- (14) When hoisting or lowering platforms, the speed shall not exceed 100 ft/min. (0.51 m/s).
- (15) Crane hoist lines shall be capable of lifting, without failure, at least 7 times the maximum intended load, except that where rotation resistant rope is used, the lines shall be capable of supporting, without failure, at least 10 times the maximum intended load. The required design factor is achieved by taking the safety factor of 3.5 and applying the 50% derating which is required in (6) above.
- (16) Hoisting of personnel shall be promptly discontinued upon indication of dangerous weather conditions, i.e., lightning, heavy rain, high winds (>15 mph), etc.

3.15.9 Ordinary Lifts

- a. The provisions of 3.15.1 through 3.15.6 shall apply.

**DEPARTMENT OF
ENERGY
HOISTING & RIGGING
MANUAL**

TITLE: OVERHEAD & GANTRY CRANES

NUMBER: 3.0

REV: 00/91

- b. The operator, or a designated person, shall assure that the special-rated capacity of the crane will not be exceeded and that the crane is still within the test-certification period.
- c. The operator, or a designated person, shall assure that the special-rated capacity of all lifting devices will not be exceeded and that they are still within the test certification period.
- d. The operator, or a designated person, shall visually examine the crane (records not required except as noted) in accordance with 3.13.2.b(1).

3.15.10 High-Consequence Lifts

- a. All of 3.15.9 shall apply.
- b. The operating organization shall appoint one person in charge (PIC) of the entire lifting operation. This person shall meet the definitions of appointed, designated, and qualified, as set forth in Section 1.0.
- c. The PIC shall be a Qualified person, or shall be assisted by a Qualified person, experienced in the use of hoisting and rigging equipment of the type to be used; in the preparation and review of drawings, procedures, and equipment assignments; and in supervision of the job.
- d. The PIC shall assure that a procedure is prepared covering the entire lifting operation. Consideration of the lift history of the crane shall affect the plan, which shall also include, but is not limited to, sling angles and sizes, inspection and test-certification periods, load configuration, the presence of hazardous materials, and the requirement for a load-indicating device. The plan must be reviewed and approved by the cognizant Safety organization.
- e. Only Qualified Operators may be assigned to operate the lifting equipment. Designated signalers shall give signals to the operator when required due to the nature of the lift.
- f. Generalized procedures may be submitted for the handling of these loads, except when detailed procedures are specified. Individual procedures for several similar items are not required unless specified. Procedures shall include identification of the item or class of items to be moved, the type of equipment and rigging accessories to be used and their special-rated capacity, any special instructions to operators, and provision for verification by the PIC that the lift or move has been satisfactorily completed. The PIC shall certify that good rigging precautions, practices, and safety measures will be employed; that equipment operators are qualified and have been properly instructed; and that equipment is adequate for the loads involved and is in good operating condition.
- g. Hoisting shall be carefully observed while tension is being applied and a check made to determine any tendency to swing or sway, and any tendency of slings to slip or change position. Sling positions shall be adjusted or additional supports or restraints shall be added as necessary before continuing the lift. Approval of changes to sling position, supports, and restraints shall be obtained from the PIC before they are made.
- h. Load tests shall not be conducted in locations such that they meet the definition of High-Consequence Lifts in Section 1.0.

3.15.11 Special-High-Consequence Lifts

- a. All of 3.15.10 shall apply.

DRAFT

DEPARTMENT OF ENERGY HOISTING & RIGGING MANUAL	TITLE: OVERHEAD & GANTRY CRANES NUMBER: 3.0 REV: 00/91
---	---

- b. In addition to those items previously required, the work plan required in 3.15.8.d shall include, as a minimum, the following:
- (1) Identification of each piece of operating equipment to be used in the move, by type, rated and special-rated capacity, and for other than permanently installed equipment, the equipment serial or other identifying number. (If the specific piece of nonpermanent equipment has not been identified at the time of the procedure specification, the number shall be included in the job instructions prepared by the appointed person.)
 - (2) Identification of slings, lifting bars, and other major rigging accessories or assemblies by serial number and weight. (If the specific items have not been identified at the time of the procedure preparation, they shall be identified in the job instructions prepared by the appointed person.)
 - (3) A list of all nonserialized rigging accessories and materials required in the move or lift, identified by type, capacity, and weight.
 - (4) Identification of the item to be moved, its weight, dimensions, and center of gravity (as determined by the method of SAE J874, or estimated from drawings or engineering analysis), and the total hook load.
 - (5) Rigging sketches showing all lifting points, load vectors, sling angles, accessories, methods of attachment, and other factors affecting the capacity of equipment and accessories used in the move, together with notation of limitations to be applied on any allowable orientation of the operating equipment or rigging accessories to be used.
 - (6) Approximate and maximum hoist and winching speeds.
 - (7) Instructions to be given to equipment operators, including sequence of equipment moves, and coordination with moves of other equipment involved; translational speeds, directions, and distances; load weight and center of gravity; and other pertinent data.
 - (8) Identification of persons who will have field responsibility for the move or lift and for monitoring it.
 - (9) Requirements for specific tests to be made before, during, and after the move or lift or practice lifts.
 - (10) Surveillance procedures, including check points, instruments, and indicators, that will be used to ensure that the move proceeds according to plan, and the special-rated capacity of the equipment has not been exceeded.
 - (11) Provision for verification by the PIC or his/her designee of satisfactory completion of each step of the procedure as it occurs.

DEPARTMENT OF ENERGY HOISTING & RIGGING MANUAL	TITLE: OVERHEAD & GANTRY CRANES
	NUMBER: 3.0 REV: 00/91

EXHIBIT I

Page 1 of 4

PERIODIC BRIDGE, WALL, GANTRY CRANE LOAD TEST AND INSPECTION

EQUIPMENT NO. _____ MAKE _____ RATED CAPACITY _____ DATE _____

LOAD TEST INSPECTION REPORT

The following checklist identifies the items to be inspected prior to the load test. All inspections shall be made in accordance with the DOE Hoisting and Rigging Manual. Any unusual conditions observed during the inspection should be noted in the remarks section.

- NOTES:**
1. Craftsmen will initial and date all tests, work, and inspections completed below.
 2. NDE Inspector shall verify all steps prior to load test.

NO.	CRANE ITEM	DEFECT	OK	NO.	CRANE ITEM	DEFECT	OK
1	Load Hook & Blocks			18	Controllers		
22	Wire Rope and End Connections			19	Relays and Coils		
33	Handrails, Walkways, and Ladders			20	Conductors and Collectors		
44	Bridge and Trucks			21	Panel Wiring		
55	Bridge Wheels and Bearings			22	Resistors		
66	Trolley and Rails			23	Bypass Switches		
77	Trolley Wheels and Bearings			24	Limit Switches		
88	Crane Alignment			25	Contractor (Electrical)		
99	Runway Rail & Clamps			26	Motors		
10	Bumpers/Endstops			27	Gauges		
11	Brake System			28	Lighting System		
12	Drive Shafts, Gears, Couplings & Bearings			29	Heater and Switches		
13	Pawls, Ratchets, Spuds, & Windlocks			30	Operator's Cab		
14	Sheaves			31	Safety		
15	Warning Devices			32	Chain and Sprockets		
16	Capacity Signs			33	Structural		
17	Main Disconnect			34	Wire Rope Drum and Machinery Foundation		

REMARKS (Unusual conditions, noises—structural cracks, misalignment, etc.)

DRAFT

**DEPARTMENT OF
ENERGY
HOISTING & RIGGING
MANUAL**

TITLE: OVERHEAD & GANTRY CRANES

NUMBER: 3.0

REV: 00/91

EXHIBIT I (continued)

Page 2 of 4

BRIDGE CRANE AND FOLLOW-UP CHECKS

- NOTES:**
1. Craftsmen will initial all steps completed below.
 2. NDE Inspector shall verify all steps below.
 3. Load test crane at 100% of manufacturers rated capacity. In no case shall the load test exceed 125% of manufacturers rated capacity. Test weights shall be accurate to -5%, + 0% of stipulated values.
 4. Load test shall be performed prior to initial use on all new, extensively repaired, or altered cranes, and when assigned to special services; thereafter, at three-year intervals and when specified in the procedures.

INITIAL

- _____ 1. Set crane up for load test and NDE Inspector verify inspection is complete prior to load test.
- _____ 2. The trip setting of hoist-limit devices shall be determined by tests, with an empty hook traveling in increasing speeds up to the maximum speed. The actuating mechanism of the limit device shall be located so that it will trip the device, under all conditions, in sufficient time to prevent contact of the hook or load block with any part of the trolley or crane.
- _____ 3. Rig test weight to hoist hook using appropriate slings.
- _____ 4. Static test: Hoisting equipment and winches shall be tested at maximum run-out of the hoisting ropes or chain, when practical.

Equipment shall hold the test load for 10 minutes, or the time required to check all primary load-bearing parts while under strain without slippage, damage, or permanent deformation of any part of the equipment.
- _____ 5. Dynamic test: As a minimum, the test load shall be raised far enough for all drums, sheaves, gears, or other rotating parts of the hoisting mechanism to complete at least one, or if possible in clearance available, two complete revolutions; then lowered until the load comes within two to three inches of the ground; and held at this level for one minute. The hoisting cycle shall be repeated at least one more time.

At least once during the lifting portion of the hoisting cycle and once during the lowering cycle, power to the hoisting equipment shall be completely turned off. There shall be no slippage of the load or overheating of the brakes.
- _____ 6. Lower the load to approximately two inches and move the bridge far enough down the runway to insure that it runs true on the rails and that no undue girder deflection occurs. Check for bridge motor, brake, and gear case overheating.

DRAFT

**DEPARTMENT OF
ENERGY
HOISTING & RIGGING
MANUAL**

TITLE: OVERHEAD & GANTRY CRANES

NUMBER: 3.0

REV: 00/91

EXHIBIT I (continued)

Page 3 of 4

- _____ 7. Operate the trolley and insure during operation that it runs true on the bridge. check trolley motor, brake, and gear case for overheating.
- _____ 8. Move the load back into the original position and slowly lower to the floor.
- _____ 9. At the completion of the load test, an inspector shall visually inspect the following load-bearing parts for signs of wear, deformation, and deterioration:

DEFECTIVE OK

- _____ a. Bridge track
- _____ b. Bridge wheels
- _____ c. Trolley track
- _____ d. Trolley wheels
- _____ e. Gears
- _____ f. Magnetic brakes
- _____ g. Blocks

Visually inspect rope in accordance with DOE Hoisting and Rigging Manual, Chapter 7.

- _____ a. Rope diameter: (Previous) _____ (Present) _____
- _____ b. Wear
- _____ c. Kinks
- _____ d. Broken wires
- _____ e. Other signs of deterioration

Visually inspect the rope drum for:

- _____ a. Wear
- _____ b. Deformation
- _____ c. Deterioration

DRAFT

DEPARTMENT OF ENERGY HOISTING & RIGGING MANUAL	TITLE: OVERHEAD & GANTRY CRANES
	NUMBER: 3.0 REV: 00/91

EXHIBIT I (continued)

Page 4 of 4

INITIAL

- _____ 10. NDE Inspector shall perform NDT test on hook by visual examination, liquid penetrant examination, or mag. particle examination. Acceptance: No cracks, linear indications, laps, or seams.

Hooks with more than 15% normal (new hook) throat opening shall be replaced. Hooks with more than 10 degrees twist from the normal (new hook) plane of the hook shall be replaced. Hooks having more than 10% wear in the throat section or 5% elongation of the shank shall be replaced. Lubricate hooks at each inspection.

Establish three marks, A, B, and C, with a center punch. For ease in measuring, set distances on an even number of inches.

BEFORE LOAD TEST

Length AB _____ in.

Length BC _____ in.

AFTER LOAD TEST

Length AB _____ in.

Length BC _____ in.

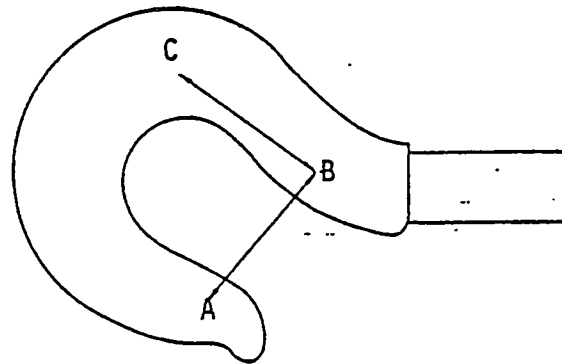

Check for:

1. Wear and deformation
2. Cracks and twisting
3. Signs of opening between Point A and Point B

Load Test Inspection Date _____

NDE Inspector _____

Operated By _____

Actual Load Test _____ lbs

DRAFT

DEPARTMENT OF ENERGY HOISTING & RIGGING MANUAL	TITLE: MOBILE CRANES NUMBER: 4.0 REV: 00/91
---	--

CONTENTS

4.1	General	4-1
4.1.1	Operator Training/Qualification	4-1
4.1.2	Load Limits/Weight	4-1
4.1.3	Load Hoist Brakes	4-1
4.1.4	Power Controlled Lowering	4-1
4.1.5	Booms	4-1
4.1.6	Rerating	4-2
4.1.7	Maintenance History	4-2
4.1.8	Design Standards	4-2
4.2	Inspections	4-2
4.2.1	General	4-2
4.2.2	Ordinary Lifts	4-3
4.2.3	High-Consequence Lifts	4-7
4.2.4	Special-High-Consequence Lifts	4-7
4.3	Testing	4-7
4.3.1	Ordinary Lifts	4-7
4.3.2	High-Consequence Lifts	4-8
4.3.3	Special-High-Consequence Lifts	4-9
4.4	Operating Practices	4-9
4.4.1	General	4-9
4.4.2	Conduct of Operator	4-10
4.4.3	Operating Near Power Lines	4-13
4.4.4	Lifting Personnel	4-17
4.4.5	Hoist-Limit Switch	4-17

DEPARTMENT OF ENERGY HOISTING & RIGGING MANUAL	TITLE: MOBILE CRANES	
	NUMBER: 4.0	REV: 00/91

4.4.6	Standard Signals	4-17
4.4.7	Identification of Signalers	4-17
4.4.8	Size of Load	4-21
4.4.9	Attaching the Load	4-21
4.4.10	Moving the Load	4-21
4.4.11	Ordinary Lifts	4-22
4.4.12	High-Consequence Lifts	4-22
4.4.13	Special-High-Consequence Lifts	4-23

FIGURES

4-1	Danger zone for cranes operating near electrical transmission lines	4-15
4-2	Standard hand signals for controlling mobile crane operators	4-18
4-3	Work areas for boom cranes	4-26

TABLES

4-1	Safe Working Distance From Power Lines	4-16
4-2	Load Table for Boom Crane	4-25

EXHIBITS

I	Periodic Mobile Crane Load Test and Inspection	4-28
---	--	------

DEPARTMENT OF ENERGY HOISTING & RIGGING MANUAL	TITLE: MOBILE CRANES	
	NUMBER: 4.0	REV: 00/91

ISSUE NO.

4.0 MOBILE CRANES

4.1 GENERAL:

This section applies to commercial truck-mounted cranes, crawler cranes, locomotive cranes, wheel-mounted cranes (multiple control stations), wheel-mounted cranes (single control station), and any variation thereof, which retain the same fundamental characteristics. These cranes rotate 360 degrees and have boom luffing capabilities.

This section specifies operation inspection, maintenance and testing requirements for the use of mobile cranes and implements the requirements of ANSI/ASME B30.5. Only equipment which has been built to appropriate design standards shall be used at DOE installations (see Section 10.0).

4.1.1 Operator Training/Qualification

Operators of mobile cranes shall be trained and qualified as required in Section 2.0, "Operator Training and Qualification."

4.1.2 Load Limits/Weight

- a. Since load rating for mobile cranes may be based upon stability, or hydraulic or structural competence, load ratings established by the manufacturers shall not be exceeded in operational application.
- b. No crane shall be loaded beyond the rated capacity, except for test purposes as provided in 4.3 of this section.
- c. When loads are to be handled which are limited by hydraulic or structural competence rather than by stability, the appointed person (see Section 1.0) shall ascertain that the weight of a load approaching rated capacity has been determined, within $\pm 10\%$ before it is lifted.

4.1.3 Load Hoist Brakes

When power-operated brakes, having no continuous mechanical linkage between the actuating and braking means, are used for controlling loads, an automatic means shall be provided to set the brake to prevent the load from falling in event of loss of brake-actuating power.

4.1.4 Power-Controlled Lowering

A power-controlled lowering system shall be provided and shall be capable of handling rated loads and speeds as specified by the manufacturer of the crane.

4.1.5 Booms

- a. Booms, boom sections, and jibs shall be clearly identified and shall be used only for the purpose recommended by the manufacturer.
- b. Lattice booms shall meet the performance requirements of SAE J987 (see Section 10.0).

DRAFT

DEPARTMENT OF ENERGY HOISTING & RIGGING MANUAL	TITLE: MOBILE CRANES NUMBER: 4.0	REV: 00/91
---	---	-------------------

4.1.6 Rerating

- a. Cranes may be modified or rerated providing such modifications are analyzed thoroughly by a Qualified Engineer or manufacturer of cranes. Such action must be approved by the cognizant safety organization.
- b. When rerated, crawler, truck, and wheel-mounted cranes shall be tested in accordance with SAE J765 (see Section 10.0).
- c. A rerating test report shall be readily available.
- d. No cranes shall be rerated in excess of the manufacturer's original load ratings.

4.1.7 Maintenance History

The maintenance history of the crane shall be retained throughout the service life of the crane.

4.1.8 Design Standards

- a. Structural, mechanical, and electrical components of the crane design shall meet accepted crane design standards, such as PCSA-1 or PCSA-2 (see Section 10.0).
- b. The safety features and operation shall conform, as a minimum, to the provisions of ANSI B30.5 (see Section 10.0).

4.2 INSPECTIONS:

4.2.1 General

Equipment shall operate with a smooth, regular motion without any hesitation, abnormal vibration, binding, gross shimmy, or irregularity. There shall be no apparent damage, excessive wear, or deformation of any part of the equipment. Brakes shall work satisfactorily and load brakes shall be able to hold any load up to at least 125% of the rated stable capacity of the equipment, without slipping or overheating. All safety devices, load indicators, boom angle and radius indicators, controls, and other operating parts of the equipment shall be checked during each inspection and shall be in good working order. Any defects shall be corrected or repaired before the equipment is put into service. Parts found to be defective as a result of any inspection or nondestructive examination shall be replaced or repaired as directed by the cognizant line manager or his/her designated representative.

- a. If an inspection has not been completed by the end of the required period, the equipment shall be downrated as follows:
 - (1) Thirty calendar days after the end of the period, the equipment shall be downrated to 75% of the rated capacity.
 - (2) Sixty calendar days after the end of the period, the equipment shall be downrated to 50% of the rated capacity.
 - (3) Ninety calendar days after the end of the period, the equipment shall be taken out of service until the required inspection has been completed.

DRAFT

4.2.2 Ordinary Lifts

- a. Prior to initial use, all new, reinstalled, altered, modified, or extensively repaired cranes shall be inspected by a certified inspector whose qualification to perform specific inspection activities has been determined, verified and attested to in writing to assure compliance with the provisions of this Manual.
- b. Inspection procedures for cranes in regular service are divided into two general classifications, based upon the intervals at which inspection should be performed. The intervals, in turn, are dependent upon the nature of the critical components of the crane and the degree of their exposure to wear, deterioration, or malfunction. The two general classifications are herein designated as "frequent" and "periodic."

- c. Frequent inspection:

The operator, or other designated person, shall visually examine the crane (records not required, except as noted) in accordance with the following schedule:

- Normal service: monthly
 - Heavy service: weekly
 - Severe service: daily
 - Special or infrequent service, as recommended by a qualified person, before and after each occurrence (with records).
- (1) Any deficiencies shall be carefully examined by a qualified person and a determination made as to whether they constitute a hazard. Inspections shall cover the following:
 - (a) All control mechanisms for maladjustment, excessive wear and contamination by lubricants or other foreign matter that could interfere with proper operation: daily.
 - (b) Crane hooks for deformations or cracks. Hooks which have cracks, or more than 15% in excess of normal throat opening, or more than 10-degrees twist from the plane of the unbent hook, shall be discarded: daily.
 - (c) Leakage in lines, trucks, valves, pumps, and other parts of air or hydraulic systems: daily.
 - (d) Hydraulic systems for proper oil level: daily
 - (e) Hoist ropes, including tightness of end clamps and rope clips.
 - (f) All safety devices for malfunction.
 - (g) Rope reeving for noncompliance with crane manufacturer's recommendations.
 - (h) Electrical apparatus for malfunctioning, signs of excessive deterioration, and dirt or moisture accumulation.

**DEPARTMENT OF
ENERGY
HOISTING & RIGGING
MANUAL****TITLE: MOBILE CRANES****NUMBER: 4.0****REV: 00/91**

- (i) Boom sections for structural integrity.
- d. Periodic inspection: 1-to12-month intervals, or as specifically recommended by the manufacturer. This shall be a visual inspection by a qualified inspector, making written, dated and signed reports of apparent external conditions. Records shall be kept on file and readily available to appointed personnel. Inspections shall be made for the following:
- (1) Loose bolts or rivets
 - (2) Cracked or worn sheaves and drums
 - (3) Hooks damaged from chemicals, deformation, cracks, or having more than 15% in excess of normal throat opening, or more than 10-degrees twist from the plane of the unbent hook.
 - (4) Worn, cracked, or distorted parts such as pins, bearings, shafts, gears, rollers, and locking devices
 - (5) Excessive wear on brake and clutch system parts, linings, pawls, and ratchets
 - (6) Load, boom angle, and other indicators over their full ranges for any significant inaccuracies
 - (7) gasoline, diesel, electrical, or other power plants for improper performance or noncompliance with safety requirements
 - (8) Radiators and oil coolers, for leakage, improper performance, or blockage of air passages
 - (9) Hooks: Dye penetrant, magnetic particle, or other suitable crack-detecting inspections should be performed at least once each year
 - (10) Travel steering, braking, and locking devices, for malfunctioning
 - (11) Excessively worn or damaged tires
 - (12) Rust on piston rods and control valves when crane has been idle
 - (13) Cleanliness of oil filters and oil strainers
- e. Inspection of Hydraulic Components:
- (1) All hydraulic hoses, particularly those which flex in normal operation of crane functions, should be visually inspected once every working day. A thorough inspection of all hoses, fittings, and rigid-tube lines should be made at least once a month. Any deterioration should be carefully examined and a determination made as to whether further use of the component would constitute a safety hazard. Conditions, such as the following, should be sufficient reason for consideration of replacement.
 - (a) Any evidence of hydraulic oil leakage at the surface of the flexible hose or its junction with the metal end couplings

DRAFT

**DEPARTMENT OF
ENERGY
HOISTING & RIGGING
MANUAL**

TITLE: MOBILE CRANES

NUMBER: 4.0

REV: 00/91

- (b) Any blistering or abnormal deformation to the outer covering of the hydraulic hose
 - (c) Hydraulic oil leakage at any threaded or clamped joint, that cannot be eliminated by normal tightening or other recommended procedures
 - (d) Evidence of excessive abrasion or scrubbing on the outer surface of a hose, rigid tube, or hydraulic fitting. Measures shall be taken immediately to eliminate the interface or to otherwise protect the components.
- (2) The following may be reason for replacement or repair of pumps and motors: loose bolts or fasteners; leaks at joints between sections; shaft-seal leaks; unusual noises or vibrations; loss of operating speed; and excessive heating of the hydraulic oil.
 - (3) The following may be reason for replacement or repair of valves: cracks in valve housing; improper return of spool to neutral position; leaks at spools or joints; sticking spools; and failure of relief valves to actuate at the correct pressure setting.
 - (4) The following may be reason for replacement or repair of cylinder: drifting caused by oil leaking across the piston; rod seals leaking; leaks at welded joints; scored, nicked, or dented cylinder rods; dented case (barrel); and loose or deformed rod eyes or connecting joints.
 - (5) Filters: Evidence of rubber particles on the filter element may indicate deterioration of hoses, "O" rings, or other rubber components. Metal chips or pieces on the filter may denote failure in pumps, motors, or cylinders. Further checking will be necessary to determine the origin of the problem before corrective action can be taken.
- f. Cranes Not in Regular Use:
- (1) A crane which has been idle for one month or more but less than six months, shall be given an inspection conforming with requirements of 4.2.2.c, above, before being placed in service.
 - (2) A crane which has been idle for over six months shall be given a complete inspection, conforming with the requirements of 4.2.2.d and 4.2.2.e, above, before being placed in service.
 - (3) Standby cranes shall be inspected at least semiannually, in accordance with the requirements of 4.2.2.c and 4.2.2.d, above: Cranes exposed to adverse environments should be inspected more frequently.
- g. Quarterly inspections shall be made on critical items in use, i.e., brakes, crane hooks, ropes, hydraulic cylinders, and hydraulic pressure-relief valves. Hydraulic pressure-relief valves shall also be checked for proper operation semiannually. Inspection records shall be kept on file and readily available.
- h. All running ropes in continuous service should be visually inspected once every working day. A thorough inspection of all ropes in use shall be made at least once each three months, and a full written, dated, and signed inspection report indicating rope condition shall be kept on file and readily available. All inspections shall be performed by a qualified inspector to assure compliance with the provisions of this manual. Any deterioration, resulting in appreciable

DRAFT

**DEPARTMENT OF
ENERGY
HOISTING & RIGGING
MANUAL**

TITLE: MOBILE CRANES

NUMBER: 4.0

REV: 00/91

loss of original strength such as described below, shall be carefully noted, and determinations shall be made as to whether further use of the rope would constitute a safety hazard:

- (1) Reduction of rope diameter below nominal diameter due to loss of core support, internal or external corrosion, or wear of outside wires
 - (2) A number of broken outside wires, and the distribution or concentration of such broken wires
 - (3) Worn outside of wires
 - (4) Corroded or broken wires at end connections
 - (5) Corroded, cracked, bent, worn or improperly applied end connections.
 - (6) Severe kinking, crushing, cutting or unstranding.
- i. A full layout inspection of all ropes shall be conducted every 12 months. This inspection shall include examination of the entire length of the rope, without detaching from the hoist drum, using magnification as necessary in questionable areas.
 - j. Heavy wear and/or broken wires may occur in sections in contact with equalizer sheaves, other sheaves where rope travel is limited, or with saddles. Particular care shall be taken to inspect ropes at these locations.
 - k. All rope which has been idle for a month or more, due to shutdown or storage of a crane on which it is installed, shall be given a thorough inspection before it is placed in service. This inspection shall be for all types of deterioration and shall be performed by an appointed or authorized person, whose approval shall be required before further use of the rope. A written and dated report of the rope condition shall be filed.
 - l. Particular care shall be taken in the inspection of nonrotating rope.
 - m. No precise rules can be given for determination of the exact time for replacement of wire rope, since many variable factors are involved. Safety in this respect depends largely upon the use of good judgment, by an appointed or authorized person, in evaluating remaining strength in a used rope after allowance for deterioration disclosed by inspection. Safety of rope operation depends upon this remaining strength.
 - n. Conditions, such as the following, shall be sufficient reason for questioning rope safety and for consideration of replacement:
 - (1) In running ropes, 6 randomly distributed broken wires in one rope lay, or 3 broken wires in one strand in one rope lay
 - (2) Wear of one-third the original diameter of outside individual wires
 - (3) Kinking, crushing, birdcaging, or any other damage resulting in distortion of the rope structure
 - (4) Evidence of any heat damage from any cause

DRAFT

TITLE: MOBILE CRANES

NUMBER: 4.0

REV: 00/91

- (5) Reduction from nominal diameter greater than those listed in following:

Rope Diameter	Maximum Allowable Reduction From Nominal Diameter
Up to 5/16 in. (8 mm)	1/64 in. (0.4 mm)
Over 5/16 in. to 1/2 in. (13 mm)	1/32 in. (0.8 mm)
Over 1/2 in. to 3/4 in. (19 mm)	3/64 in. (1.2 mm)
Over 3/4 in. to 1 1/8 in. (29 mm)	1/16 in. (1.6 mm)
Over 1 1/8 in. to 1 1/2 in. (38 mm)	3/32 in. (2.4 mm)

- (6) In standing ropes, more than two broken wires in one lay in sections beyond end connections, or more than one broken wire at an end connection.
- d. In order to establish data as a basis for judging the proper time for replacement, a continuing inspection record shall be maintained. This record shall cover points of deterioration listed above. (Discarded rope shall not be used for slings.)
- e. Replacement rope shall be of the same size, grade, and construction as recommended by the crane manufacturer, unless otherwise recommended by a rope or crane manufacturer due to actual working condition requirements.

4.2.3 High-Consequence Lifts

- a. All provisions of 4.2.2 shall apply.
- b. Equipment shall receive major inspections when first assigned to this service and at 12-month intervals thereafter. Major inspections shall include all points and items covered by the equipment manufacturer's recommendations (when available). Periodic inspection, in accordance with 4.2.2.d, load testing in accordance with Section 4.3, and nondestructive examination (magnetic particle or liquid penetrant) of hooks and, when required by the inspector, welds, bearings, or other suspect loadbearing parts shall be done at the specified intervals. NDE shall be in accordance with pertinent sections of applicable ASTM Standards. Annual maintenance shall be carried out prior to or during major inspections. Items for inspection are included in Exhibit I, "Periodic Mobile Crane Load Test & Inspection," which appears at the end of this Section.

4.2.4 Special-High-Consequence Lifts

- a. All provisions of 4.2.3 shall apply.

4.3 TESTING:

4.3.1 Ordinary Lifts

- a. Prior to initial use, all new, extensively repaired, or altered cranes shall be tested and inspected by a qualified inspector. Written reports shall be furnished by such persons showing test procedures and confirming the adequacy of repairs or alterations. Test loads shall not exceed 110% of the manufacturer's rated capacity at any selected working radius.

DRAFT

**DEPARTMENT OF
ENERGY
HOISTING & RIGGING
MANUAL**

TITLE: MOBILE CRANES

NUMBER: 4.0

REV: 00/91

- b. The following shall also be tested during the initial test: load-hoisting and-lowering mechanism with a suspended load; boom-hoisting and-lowering mechanism; boom-extension mechanism; swinging mechanism; travel mechanism; and safety devices.
- c. Equipment shall be routinely load tested by certified personnel when assigned to service, thereafter at 12 month intervals, and when specified in the procedures. Load tests shall be made in an area where no critical items are installed, being worked on, or stored. Records shall be kept on file and readily available. Before starting the load test, equipment shall be inspected in accordance with 4.2.2.d. Defective parts shall be replaced or repaired before starting the load test.
- d. The load test in 4.3.1.c. above shall not exceed the rated capacity of the crane. Test weights shall be accurate to within -5%, +0% of stipulated values.
- e. If a test has not been completed by the end of the required period, the equipment shall be downrated as follows:
 - (1) Thirty calendar days after the end of the period, the equipment shall be downrated to 75% of the rated capacity.
 - (2) Sixty calendar days after the end of the period, the equipment shall be downrated to 50% of the rated capacity.
 - (3) Ninety calendar days after the end of the period, the equipment shall be taken out of service until the required inspection has been completed.

4.3.2 High-Consequence Lifts

- a. All provisions of 4.3.1 shall apply.
- b. Equipment shall be load tested when assigned to this service, thereafter at 12-month intervals, and when specified in the procedures if deemed necessary by the designated authority due to ground conditions, weather or peculiar circumstances. Load tests shall be made in an area where no critical items or equipment for handling critical items are installed, being worked on, or stored. Load tests shall, if possible, be made at the same location and at the same crane configuration as will be encountered when making the high-consequence lift. Before starting the load test, equipment shall be inspected in accordance with 4.2.2.d. Defective parts shall be replaced or repaired before starting the load test.
- c. Routine load tests may be made with a hook load equal to 100% of the rated capacity of the crane. Preload tests, when required, shall be made with a hook load of 110% of the combined weight of the item to be lifted and the lifting tackle. In no case shall the load test exceed the rated capacity of the equipment. Test results shall be recorded.
 - (1) **Static Test:** Equipment shall hold the test load for 10 minutes, or the time required to check all primary load-bearing parts while under strain without slippage, damage, or permanent deformation of any part of the equipment. Hoisting equipment and winches shall be tested at maximum run-out of the hoisting ropes or chain, when practical.
 - (2) **Dynamic Test:** Hoisting equipment shall be operated through at least two complete cycles of all movements which the equipment will encounter in service while supporting the test load. As a minimum, the test load shall be raised far enough for all

DRAFT

DEPARTMENT OF ENERGY HOISTING & RIGGING MANUAL	TITLE: MOBILE CRANES NUMBER: 4.0 REV: 00/91
---	--

drums, sheaves, gears, or other rotating parts of the hoisting mechanism to complete at least one or if possible in the clearance available, two complete revolutions; then lowered until the load comes within 2 to 3 in. of the ground; and held at this level for one minute. The hoisting cycle shall be repeated at least one more time. Tests shall be made by the operator who normally operates the equipment, who shall demonstrate his ability to positively control the load during all lateral, rotational, and vertical motions which will be encountered in service. At least once during the lifting portion of the hoisting cycle and once during the lowering cycle, power to the hoisting equipment shall be completely turned off. There shall be no slippage of the load or overheating of the brakes.

4.3.3 Special-High-Consequence Lifts

- a. All provisions of 4.3.2 shall apply.
- b. Equipment shall be load tested before lifting any Special-High-Consequence Load. Load tests shall be made in an area where no critical items or equipment for handling critical items are installed, being worked on, or stored. Load tests shall, if possible, be made at the same location and at the same crane configuration as will be encountered when making the special high-consequence lift. Before starting the load test, equipment shall be inspected in accordance with 4.2.2.d. Defective parts shall be replaced or repaired before starting the load test.

4.4 OPERATING PRACTICES:

4.4.1 General

- a. An appointed person shall classify each lift into one of the DOE categories prior to planning the lift.
- b. The operator shall not engage in any practice which will divert his/her attention while operating the crane.
- c. The operator shall not operate the crane when physically or mentally incapacitated.
- d. The operating area shall be kept free of water, snow, ice, oil and debris, that could cause the operators hands and feet to slip from the controls.
- e. Operating cab windshields shall be kept clean and free of anything that obstructs vision.
- f. Special consideration should be given to the proper functioning of tires, horn, lights, battery, controller, lift system (including load-engaging means, chains, hoist rope, and limit switches), brakes, and steering mechanisms. If at any time a lifting device is found to be in need of repair, defective, or in any way unsafe, the matter shall be reported immediately to the designated authority and the unit shall be taken out of service until it has been restored to safe-operating condition or a determination has been made by the cognizant manager that the discrepancy will not adversely affect the safe operation of the unit.
- g. When two or more cranes are used to lift one load, one designated person shall be responsible for the operation. That person shall analyze the operation and instruct all personnel involved in the proper positioning, rigging of the load, and the movements to be made. Decisions such as the necessity to reduce crane ratings, position of load, boom location, ground support, and speed of movement shall be in accord with the designated person's determination.

DRAFT

**DEPARTMENT OF
ENERGY
HOISTING & RIGGING
MANUAL**

TITLE: MOBILE CRANES

NUMBER: 4.0

REV: 00/91

- h. A determination shall be made that no one is working on or in close proximity to the crane prior to starting the engine or beginning to operate.
- i. Two or more separately rigged loads shall not be hoisted in one lift, even though the combined load is within the crane's rated capacity.
- j. The following precautions shall be followed when fueling the crane:
 - (1) Engines shall be stopped.
 - (2) Smoking or open flame shall not be permitted within 25 ft. of the fueling area.
- k. A 5BC, or larger, fire extinguisher shall be installed at all operator stations. Fire extinguishers shall be maintained in a serviceable condition.
- l. Gasoline, acids, caustics, or cleaning solvents that emit toxic fumes shall not be stored in operating cabs.
- m. Fuel shall be stored in safety cans in safe locations.
- n. Alternate egress routes shall not be locked on mobile units with operating enclosures.

4.4.2 Conduct of Operator

- a. The crane shall be positioned on as solid and level a footing as possible. It may be necessary in certain situations to use heavy timber mats to build a good working foundation.
- b. When traveling the machine:
 - (1) Secure the boom and hook block.
 - (2) Check bridges before crossing; make sure they will support the weight of the machine.
 - (3) Check river depths when fording.
 - (4) Check clearances under bridges, overhead lines, or any overhead obstruction. When side clearances are tight, install a barrier or post a lookout, and make certain there is sufficient clearance for tail swing.
 - (5) When traveling with a load, snub the load to prevent swaying if possible. Never travel with near-capacity loads.
 - (6) Never travel a rubber-tired unit with a load over the side.
 - (7) In soft going, always move with the load behind; it helps to raise the leading end of the crawlers and makes traveling safer.
 - (8) Always set swing brakes when the unit is idle or holding loads for a period of time, especially on slopes. If swinging during travel is necessary, engage swing-jaw clutch before releasing brakes.
 - (9) Never back up until it is determined that everyone is clear of the machine.

DRAFT

**DEPARTMENT OF
ENERGY
HOISTING & RIGGING
MANUAL**

TITLE: MOBILE CRANES

NUMBER: 4.0

REV: 00/91

- (10) Position the boom in direction of travel for long moves.
 - (11) Block treads when moving uphill; be sure they are blocked to prevent downhill movement before shifting steering clutches.
- c. When making adjustments or repairs:
- (1) Stop the machine.
 - (2) Lower the boom, or secure it against dropping.
 - (3) Neutralize all controls.
 - (4) Lock starter and remove ignition key to make it inoperative.
 - (5) Display proper warning signs on controls of machine.
 - (6) Keep hands, feet, and clothing away from gears, ropes, drums, and sheaves.
 - (7) Never put hands on wire rope when climbing to the top of the cab.
 - (8) Use a bar or stick to guide wire ropes onto drums.
 - (9) Keep hands well away from the fan drive while engine is running.
 - (10) Safeguard the crane oiler; do not resume operation until he/she gives a positive ALL CLEAR signal.
 - (11) Replace all guards and shields before resuming operation.
- d. Block under boom before disassembling. Never stand on or under the boom during this work.
- e. Before disconnecting oil lines, if machine has hydraulic controls, be sure to place boom on the ground or in the boom rest; then move the pedals and control levers to equalize pressures within the cylinders. Always release any air supercharge on the hydraulic reservoir and shut off the engine (or declutch pumps) before disconnecting oil lines.
- f. Do not reach into hydraulic-boom holes unless the sections are securely anchored together.
- g. Lock the turntable before traveling on a highway. Use a house lock or swing brake, and lower boom into the rack to prevent swing.
- h. When loading machine on the trailer, always use a ramp; if a ramp is not available, use blocking to build one.
- i. Know the rated capacity of the crane. A safe load depends upon boom length, boom angle, and working radius. Follow these suggestions to avoid buckling the boom or tipping:
- (1) Know the radius of the load. The radius is measured from center of rotation, not from the boom foot pin.
 - (2) Always operate within the rated capacity of the machine.

DRAFT

**DEPARTMENT OF
ENERGY
HOISTING & RIGGING
MANUAL**

TITLE: MOBILE CRANES

NUMBER: 4.0

REV: 00/91

- (3) The rated capacity includes weight of hook, block, and any material-handling devices, such as concrete bucket, magnet. Subtract the weight of all these to find the true weight of the load you can handle safely.
 - (4) Ratings are based on operating the machine on firm, level ground. Outriggers should be properly extended and/or lowered before operation.
 - (5) Avoid fast swings, hoists, or sudden braking; these can cause overloads.
 - (6) Do not handle large, heavy loads in strong winds. The wind can catch the load and create an unstable condition.
- j. Use extreme caution when operating the crane near workers in elevated areas.
 - k. Use power lowering when lowering loads. When lowering heavy loads, keep the hoist brake as reserve. Use a safety pawl on the boom-hoist drum when not lowering.
 - l. Test stability before lifting heavy loads. Check outrigger footing. Lift load slightly off the ground and stop. Check the machine for movement and check to be sure the brakes hold with the load elevated. Never use machine stability to determine capacity. If there are any indications of tipping, the machine is already overloaded for that working radius.
 - m. Always use the shortest boom possible, and observe these precautions with any boom length:
 - (1) Make only vertical lifts. Never pull the load sideways.
 - (2) Keep speed slow in lifting and lowering loads.
 - (3) Swing carefully and slowly, and avoid boom or jib "whipping." Check counter balance clearance.
 - (4) Do not let the load strike the boom or outriggers.
 - (5) Allow maximum clearance between the hook block and head sheaves.
 - (6) Keep near-capacity loads as close to the ground as possible.
 - (7) Avoid hitting anything with the boom. An engineering analysis shall be made before putting the crane back in service if this occurs.
 - n. When swinging, watch out for centrifugal force. Swing the crane slowly to avoid an outward swing of the load. Attach a tag-line to the load if necessary to control the swing.
 - o. Watch for boom "kickback." Never operate with the boom at a higher angle than shown on the capacity charts.
 - p. Do not back crane away from the load while carrying a maximum load; this may cause the crane to tip.
 - q. Avoid "two-blocking," caused when the hook block makes contact with boom-point sheaves. Continuous pull on the hoist lines can break the rope or pull the boom back over the cab on some types of booms. On hydraulically telescoping booms, be sure to play out the hoist line when extending and spool in the hoist line when retracting.

DRAFT

DEPARTMENT OF ENERGY HOISTING & RIGGING MANUAL	TITLE: MOBILE CRANES	REV: 00/91
	NUMBER: 4.0	

- r. Always use outriggers when making lifts (with pick-and-carry units), and never lift a load forward of the front outriggers, unless shown on manufacturer's rating chart.
- s. Lower outrigger jacks to completely remove all machine weight from the tires, and level unit to reach the machine's full capacity. Recheck and, if necessary, reset outriggers between heavy lifts.
- t. Always extend outrigger beams completely.
- u. Lock carrier air brakes ON when operating, and check the pressure of the air brakes frequently.
- v. Watch out for the carrier-cab on truck-mounted units when swinging the boom. Keep boom high enough to swing clear of cab.

4.4.3 Operating Near Power Lines

- a. Use extreme caution when traveling or working near power lines. Special procedures are required.
 - (1) Except where the electrical distribution and transmission lines have been deenergized and visibly grounded at the point of work or where insulating barriers not a part of or an attachment to the crane have been erected to prevent physical contact with the lines, cranes shall operate so that no part of the crane or load enters into the "danger zone," shown in Figure 4-1.
 - (a) For lines rated 50 kV or below, minimum clearance between the lines and any part of the crane or load (including handling appendages) shall be 10 feet (3.05 m). For higher voltages, consult Table 4-1.
 - (b) Caution shall be exercised when working near overhead lines having long spans as they tend to move laterally or vertically due to the wind which could cause them to breach the safety zone.
 - (c) In transit with no load, and boom lowered, the clearance shall be as specified in Table 4-1.
 - (d) A qualified signal person shall be assigned to observe the clearance and give warning before approaching the above limits.
 - (2) If cage-type boom guards, insulating links, or proximity-warning devices are used on cranes, such devices shall not be a substitute for the requirements of Paragraph 4.4.3.a(1), even if such devices are required by law or regulation. In view of the complex, invisible, and lethal nature of the electrical hazard involved, and to lessen the potential of false security, limitation of such devices, if used, shall be understood by operating personnel and tested in the manner and in the intervals prescribed by the manufacturer of the device. Compliance with Paragraph 4.4.3.a(1) is the recommended practice of this standard in determining proximity of the crane and its protuberances, including load, to electric power lines.
 - (3) Before the commencement of operations near electrical conductors, the person responsible for the job shall notify the owners of the lines, or their authorized

DRAFT

**DEPARTMENT OF
ENERGY
HOISTING & RIGGING
MANUAL****TITLE: MOBILE CRANES****NUMBER: 4.0****REV: 00/91**

representatives, and provide them with all pertinent information and request their cooperation.

- (4) Any overhead conductor shall be considered to be energized unless and until the person owning such conductor or the electrical utility authorities verify that it is not energized.
- (5) The Electric Power Marketing Agencies in DOE may deviate from the requirements of Table 4-1 providing the work is done according to line management-approved procedures which are not in conflict with statutory regulations, or approved variances from these regulations.
- (6) Durable signs shall be installed at the operator's station and on the outside of the crane, warning that electrocution or serious bodily injury may occur unless a minimum clearance of 10 feet (3.05 m) is maintained between the crane or the load being handled and energized power lines. Greater clearances are required because of higher voltage as stated in 4.4.3.a(1). These signs shall be revised but not removed when local jurisdiction requires greater clearances.

DRAFT

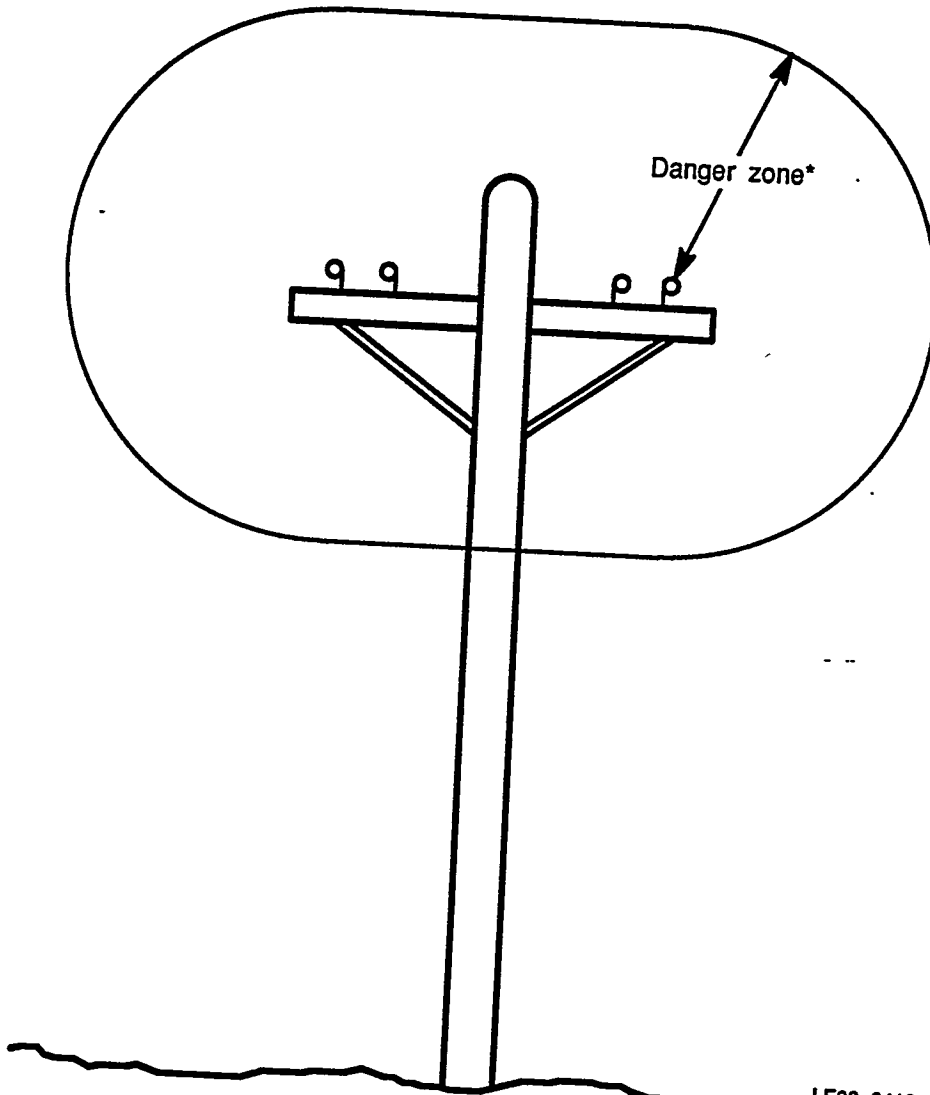

LF90-0118

*For minimum radial distance of danger zone, see 4.4.3a(1)

Figure 4-1. Danger Zone for cranes and lifted loads operating near electrical transmission lines.

SAFE WORKING DISTANCE FROM POWER LINES

Table 4-1

a. When operating near high voltage power lines:

Normal Voltage (phase to phase)				Minimum Required Clearance
		to	50 kV	10 ft. (3.05 m)
Over	50	to	200 kV	15 ft. (4.60 m)
Over	200	to	350 kV	20 ft. (6.10 m)
Over	350	to	500 kV	25 ft. (7.62 m)
Over	500	to	750 kV	35 ft. (10.67 m)
Over	750	to	1000 kV	45 ft. (13.72 m)

b. While in transit with no load and boom or mast lowered:

Normal Voltage (phase to phase)				Minimum Required Clearance
		to	0.75 kV	4 ft. (1.22 m)
Over	0.75	to	50 kV	6 ft. (1.33 m)
Over	50	to	345 kV	10 ft. (3.05 m)
Over	345	to	700 kV	16 ft. (4.87 m)
Over	750	to	1000 kV	20 ft. (6.10 m)

TITLE: **MOBILE CRANES**

NUMBER: **4.0**

REV: **00/91**

4.4.4 Lifting Personnel

- a. No lifting, lowering, or swinging shall be done while a worker is on the hook, load, or manlift platform attached to the crane load line except as stipulated in 3.15.6. The following additional requirements shall also apply:
- (1) A boom angle indicator, readily visible to the operator, shall be provided on cranes/derricks with variable angle booms.
 - (2) Prior to hoisting personnel, an accurate determination of the load radius to be during the lift shall be made. Cranes with telescoping booms shall be equipped with a device to indicate clearly to the operator, the boom's extended length.
 - (3) The crane shall be operated so that downward motion will be controlled lowering and load/boom hoist drum brakes, swing brakes, and locking devices such as pawls or dogs shall be engaged when an occupied personnel platform is in a stationary working position.
 - (4) The crane shall not travel while personnel are on the platform.
 - (5) The crane shall be uniformly level within 1% of level grade and located on firm footing. Cranes equipped with outriggers shall have them fully deployed.

4.4.5 Hoist-Limit Switch

- All limit switches, if supplied, shall be checked without a load on the hook, at the beginning of each work shift, or the first time the crane is used that shift. Each motion shall be "inched" into its limit switch. (If a lift is in progress during a shift change, this testing requirement is considered to have been satisfied for the completion of that lift. However, the limit switch must be tested again before the next lift.)

4.4.6 Standard Signals:

The standard signals for DOE use shall be as specified in the latest edition of the American National Standards Institute (ANSI) B30 chapters, for the particular type of crane or hoist being used. (See Figure 4-2.)

4.4.7 Identification of Signalers:

- a. All personnel acting as signalers during crane operations shall be clearly identified to the crane operator by the use of the following (one or more, as required by the cognizant manager): orange hardhat; orange gloves; and/or orange vest. This requirement may be waived by the cognizant manager when the lift is very closely controlled and personnel are required to wear special clothing for protection from a hazardous environment.
- b. In those cases where the crane operator cannot see the signaler, a second person (relay signaler) shall be stationed where he/she can see both the signaler and the crane operator and relay the signals to the operator. The relay signaler shall also be clearly identified by the items in 4.4.7.a, above.
- c. Where voice (direct or two-way radio) communication is used, the signaler shall communicate directly with the operator; not through a third person.
- d. The operator shall recognize signals only from the designated signaler, except that a signal for a stop shall be obeyed when given by anyone.

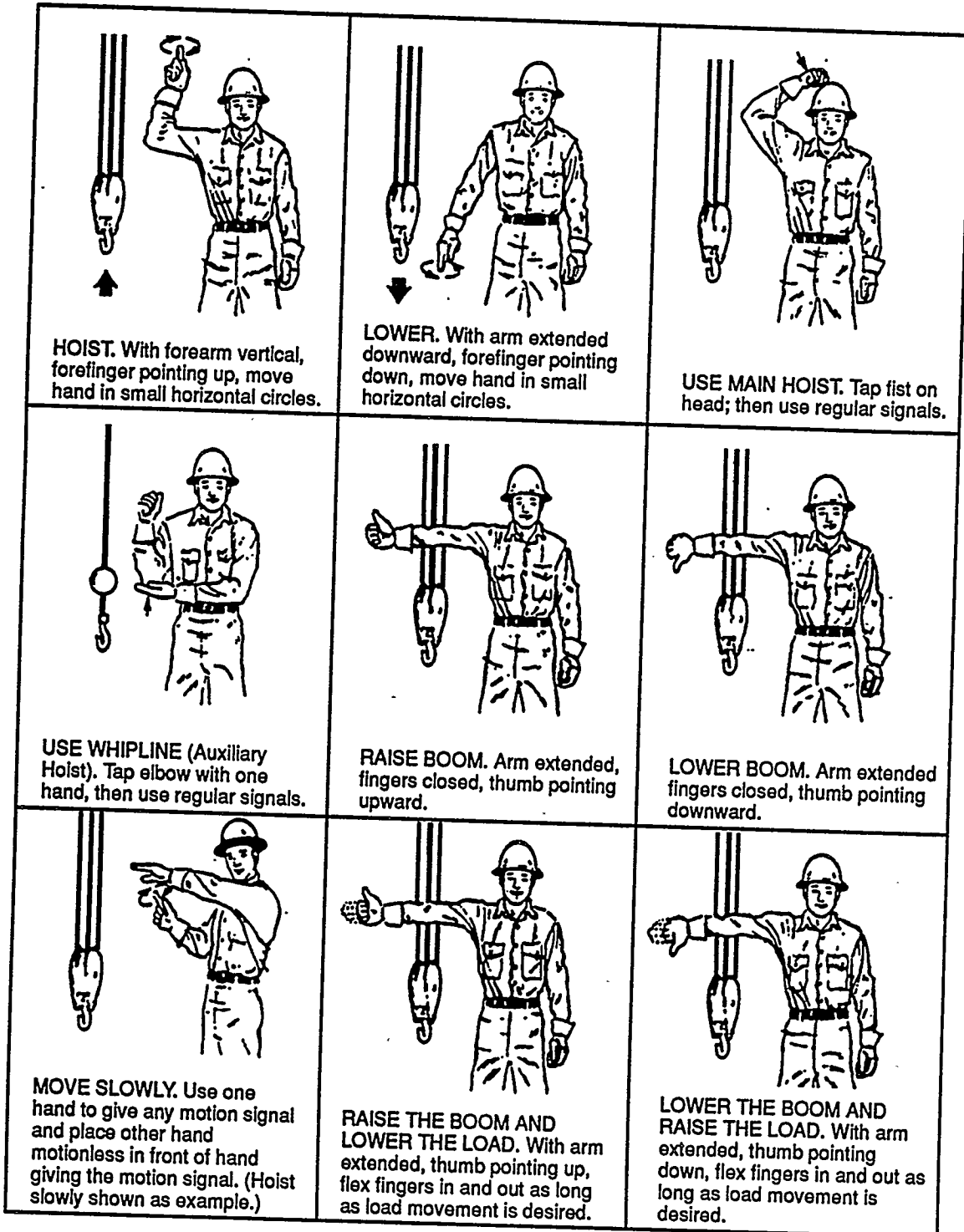

FIG. 4-2

Figure 4-2. Standard Hand Signals for Controlling Mobile Crane Operators

DRAFT

**DEPARTMENT OF
ENERGY
HOISTING & RIGGING
MANUAL**

TITLE: MOBILE CRANES

NUMBER: 4.0

REV: 00/91

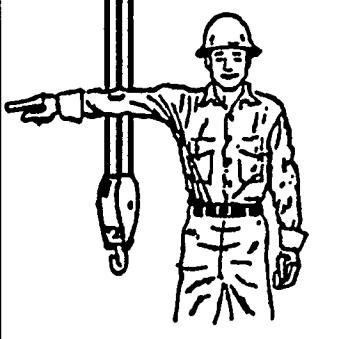
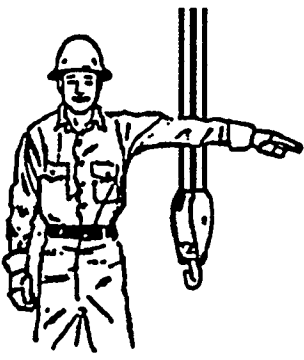
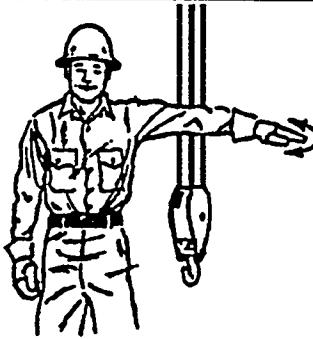
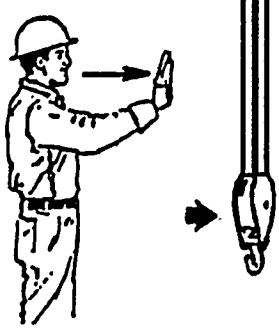
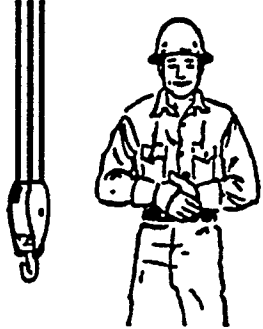
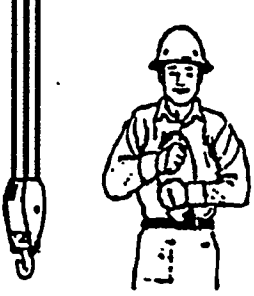
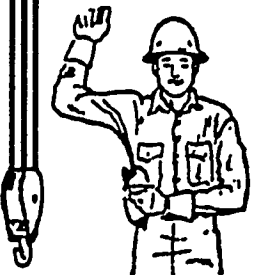
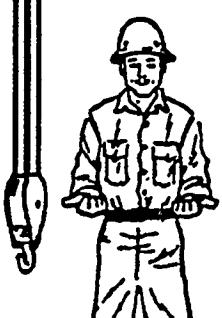
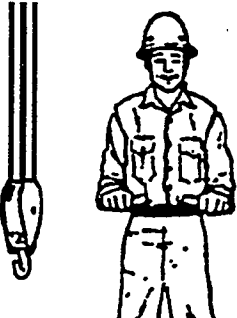
 <p>SWING. Arm extended point with finger in direction of swing of boom.</p>	 <p>STOP. Arm extended, palm down, hold position rigidly.</p>	 <p>EMERGENCY STOP. Arm extended, palm down, move hand rapidly right and left.</p>
 <p>TRAVEL. Arm extended forward, hand open and slightly raised, make pushing motion in direction of travel.</p>	 <p>DOG EVERYTHING. Clasp hands in front of body.</p>	 <p>TRAVEL (Both Tracks). Use both fists in front of body, making a circular motion about each other, indicating direction of travel; forward or backward. (for land cranes only).</p>
 <p>TRAVEL (One Side Track). Lock the track on side indicated by raised fist. Travel opposite track indicated by circular motion of other fist, rotated vertically in front of body. (for land cranes only).</p>	 <p>EXTEND BOOM (Telescoping Booms). Both fists in front of body with thumbs pointing outward.</p>	 <p>RETRACT BOOM (Telescoping Booms). Both fists in front of body with thumbs pointing toward each other.</p>

LF90-0126

Figure 4-2. (continued)

DRAFT

DEPARTMENT OF ENERGY HOISTING & RIGGING MANUAL	TITLE: MOBILE CRANES NUMBER: 4.0 REV: 00/91
---	--

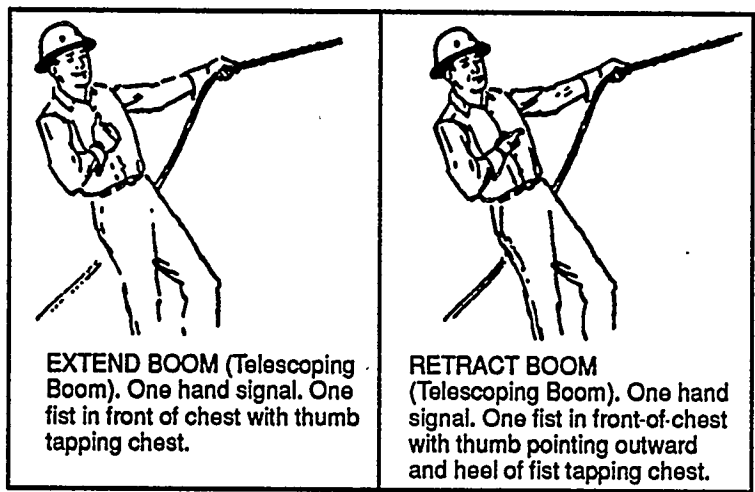

LF90-0127

Figure 4-2. (continued)

4.4.8 Size of Load:

The crane shall not be loaded beyond its special-rated capacity, except as may be provided in 4.3 of this Section.

4.4.9 Attaching the Load:

- a. The hoist rope shall be free from kinks or twists and shall not be wrapped around the load.
- b. The load shall be attached to the load-block hook by means of slings or other approved devices.
- c. Care shall be taken to make certain that the sling clears all obstacles.

4.4.10 Moving the Load:

- a. The appointed person directing the lift shall see that the load is well secured and properly balanced in the sling or lifting device before it is lifted more than a few inches.
- b. Before starting to hoist, note the following conditions:
 - (1) Hoist rope shall not be kinked.
 - (2) Multiple-part lines shall not be twisted around each other.
 - (3) The hook shall be brought over the load in such a manner as to prevent swinging.
 - (4) If there is a slack-rope condition, it should be determined that the rope is properly seated on the drum and in the sheaves.
 - (5) The qualified rigger is clear of the load.
- c. During hoisting, care shall be taken that:
 - (1) There is no sudden acceleration or deceleration of the moving load.
 - (2) Load does not contact any obstructions. A "dry run" shall be conducted in areas where clearance is limited.
- d. Cranes shall not be used for side pulls, except when specifically authorized by a designated person who has determined that the stability of the crane is not thereby endangered and that various parts of the crane will not be overstressed.
- e. The operator shall not move loads over people.
- f. The operator shall test the brakes each time a load approaching the special-rated capacity is handled by raising the load a few inches and applying the brakes.
- g. The load shall not be lowered below the point where less than two full wraps of rope remain on the hoisting drum.
- h. The operator shall not leave his/her position at the controls while the load is suspended, unless required to do so by an approved emergency procedure.

**DEPARTMENT OF
ENERGY
HOISTING & RIGGING
MANUAL**

TITLE: MOBILE CRANES
NUMBER: 4.0
REV: 00/91

- i. Work on suspended loads is prohibited under normal conditions. When the cognizant manager decides that it is necessary to work on a suspended load, safe guidelines shall be established through consultation with the appropriate safety organization. Suspended loads that must be worked on shall be secured against unwanted movement.
- j. A tag line shall be used when it becomes necessary to guide, snub, or otherwise control the load.

4.4.11 Ordinary Lifts:

- a. The provisions of 4.4.1 through 4.4.10 shall apply.
- b. All cranes shall be inspected by a designated person to assure that the special-rated capacity will not be exceeded, and that they are still within the test-certification period.
- c. All lifting devices shall be inspected by a designated person to assure that the special-rated capacity of each item of equipment will not be exceeded, and that all items are still within the test-certification period, if appropriate.
- d. Inspections for damage and defects shall be conducted as specified in 4.2.2.c, including observations during operation. Deficiencies shall be examined by a qualified person, and a determination made as to whether they constitute a hazard.
- e. Hoist limit switches, if provided shall be checked as specified in 4.4.5.
- f. Basic operating instructions of power-operated equipment, together with charts, tables, or diagrams showing the special-rated capacity, boom angle, swing, and stability data shall be posted in convenient view of the operator
- g. Load lines shall be checked after strain is put on them but before the load is lifted clear of the ground; if not plumb, the slings or equipment shall be repositioned so that the lines are plumb before continuing.

4.4.12 High-Consequence Lifts:

- a. All of 4.4.11 shall apply.
- b. The operating organization shall appoint one person to be in charge of the entire lifting operation (PIC). This person shall meet the definitions of appointed, designated, and qualified, as set forth in Section 1.0.
- c. The PIC shall be a Qualified Person or shall be assisted by a Qualified Person, experienced in using hoisting and rigging equipment of the type to be used; preparing and reviewing drawings, procedures, and equipment assignments; and supervising the job.
- d. The PIC shall assure that a work plan is prepared covering the entire lifting operation. Consideration of the lift history of the crane shall affect the plan, which shall also include, but is not limited to, sling angles and sizes; inspection and test-certification periods; load configuration; the presence of hazardous materials; and the requirement for a load-indicating device. The plan must be reviewed and approved by the cognizant Safety organization.
- e. Hoisting shall be carefully observed while tension is being applied and a check made to determine any tendency to swing or sway, and any tendency of slings to slip or change

DRAFT

DEPARTMENT OF ENERGY HOISTING & RIGGING MANUAL	TITLE: MOBILE CRANES NUMBER: 4.0 REV: 00/91
---	--

position. Sling positions shall be adjusted or additional supports or restraints shall be added as necessary before continuing the lift. Procedural approval of changes to sling position, supports, and restraints shall be obtained from the appointed person before they are made.

- f. Only Qualified Operators may be assigned to operate the lifting equipment. Designated signalers shall give signals to the operator when required due to the nature of the lift.
- g. Generalized procedures may be submitted for the handling of these loads, except when detailed procedures are specified. Individual procedures for several similar items are not required, unless specified. Procedures shall include identification of the item or class of items to be moved, the type of equipment and rigging accessories to be used and their special-rated capacity, any special instructions to operators, and provision for verification by the authorized person that the lift or move has been satisfactorily completed. The PIC shall certify that good rigging practices, precautions, and safety measures shall be employed, that equipment operators are qualified and have been properly instructed, and the equipment is adequate for the loads involved and in good operating condition.
- h. Load tests will not be conducted in locations such that the lift meets the definition of A High-Consequence Lift in Section 1.0.

4.4.13 Special-High-Consequence Lift:

- a. All of 4.4.12 shall apply.
- b. In addition to those items previously required, the work plan required in 4.4.12.d shall include, as a minimum, the following:
 - (1) Identification of each piece of operating equipment to be used in the move by type, rated and special-rated capacity, and, for other than permanently installed equipment, the equipment serial number or other identifying number. (If the specific piece of nonpermanent equipment has not been identified at the time of procedure specification, the number shall be included in the job instructions prepared by the appointed person.)
 - (2) Identification of slings, lifting bars, and other major rigging accessories or assemblies, by serial number and weight. (If the specific items have not been identified at the time of procedure preparation, they shall be identified in the job instructions prepared by the appointed person.)
 - (3) A list of all nonserialized rigging accessories and materials required in the move or lift, identified by type, and capacity and weight.
 - (4) Identification of the item to be moved, its weight, dimensions, and center of gravity (as determined by the method of SAE J874 or estimated from drawings or engineering analysis), and the total hook load.
 - (5) Rigging sketches showing all lifting points, load vectors, sling angles, accessories, methods of attachment, boom angles, crane orientations, and other factors affecting the capacity of equipment and accessories used in the move, together with notation of limitations to be applied on any allowable orientation of the operating equipment or rigging accessories to be used.
 - (6) Approximate and maximum hoist and winching speeds.

DRAFT

**DEPARTMENT OF
ENERGY
HOISTING & RIGGING
MANUAL****TITLE: MOBILE CRANES****NUMBER: 4.0****REV: 00/91**

- (7) Instructions to be given to equipment operators, including boom and swing angles at each step of the move, sequence of equipment moves, and coordination with moves of other equipment involved; translational speeds, direction, and distances, load weight, center of gravity, and other pertinent data.
- (8) Identification of persons who will have field responsibility for the move or lift and for monitoring it.
- (9) Requirements for specific tests to be made before, during, and after the move or lift, including load test for Special-High-Consequence Loads or practice lift.
- (10) Surveillance procedures, including check points, instruments, and indicators, that will be used to ensure that the move proceeds according to plan and the special-rated capacity of the equipment has not been exceeded.
- (11) Provisions for verification by the appointed person or his/her designee of satisfactory completion of each step of the procedure as it occurs.

DRAFT

DEPARTMENT OF ENERGY HOISTING & RIGGING MANUAL	TITLE: MOBILE CRANES NUMBER: 4.0	REV: 00/91
---	---	-------------------

Table 4-2. Load table for boom crane

This table is an illustration of the type of the load table which should be included in each boom crane.

Manitowoc Model 3900 Liftcrane Extra-Heavy Boom

Working radius	50'	60'	70'	80' lbs.	90'	100'	120'	140'
12	120 000	120 000						
14	111 200	110 800						
16	104 200	103 600	109 000					
18	97 800	97 400	102 700	100 000	95 000			
20			97 000	96 600	92 500	90 000		
22	93 200	92 400	91 600	90 600	89 600	86 000	83 000	
24	87 800	86 800	85 800	84 800	83 800	82 800	80 000	
26	83 400	81 200	80 300	79 400	78 700	77 800	75 200	
28	75 900	75 500	74 700	73 900	73 200	72 600	70 500	66 500
30	68 100	67 700	67 300	66 900	66 400	65 800	64 000	63 100
32								59 800
34	61 700	61 300	60 900	60 500	60 000	59 400	58 500	56 400
36	56 500	56 100	55 700	55 300	54 800	54 200	53 300	52 300
38	52 000	51 600	51 200	50 800	50 300	49 700	48 800	47 800
40	48 100	47 700	47 300	46 900	46 400	45 800	44 900	43 900
42	44 700	44 300	43 900	43 500	43 000	42 400	41 500	40 500
44								
46	41 700	41 300	40 900	40 500	40 000	39 400	38 500	37 500
48	39 100	38 700	38 300	37 900	37 400	36 800	35 900	34 900
50	36 800	36 400	36 000	35 600	35 100	34 500	33 600	32 600
52	34 700	34 300	33 900	33 500	33 000	32 400	31 500	30 500
54	32 900	32 500	32 100	31 700	31 200	30 600	29 700	28 700
56								
58	31 200	30 800	30 400	30 000	29 500	28 900	28 000	27 000
60		29 300	28 900	28 500	28 000	27 400	26 500	25 500
65		27 900	27 500	27 100	26 600	26 000	25 100	24 100
70		26 500	26 100	25 700	25 200	24 600	23 700	22 700
75		25 300	24 900	24 500	24 000	23 400	22 500	21 500
80								
85		24 200	23 800	23 400	22 900	22 300	21 400	20 400
90			21 300	20 900	20 400	19 800	18 900	17 900
95			19 300	18 900	18 400	17 800	16 900	15 900
100				17 100	16 600	16 000	15 100	14 100
110								
120				15 700	15 200	14 600	13 700	12 700
					13 900	13 300	12 400	11 400
					12 700	12 100	11 200	10 200
						11 100	10 200	9 200
						10 200	9 300	8 300
							6 800	5 800
							4 500	3 840

Notes:

- a. Above ratings are maximum recommended working loads. Loads between dotted lines are computed at 75% of tipping load across treads; machine on firm, level ground. Loads outside of dotted lines limited by strength of boom.
- b. For booms 80 ft and over, use cambered center section; for booms 100 ft and over, use deep section inserts.

DRAFT

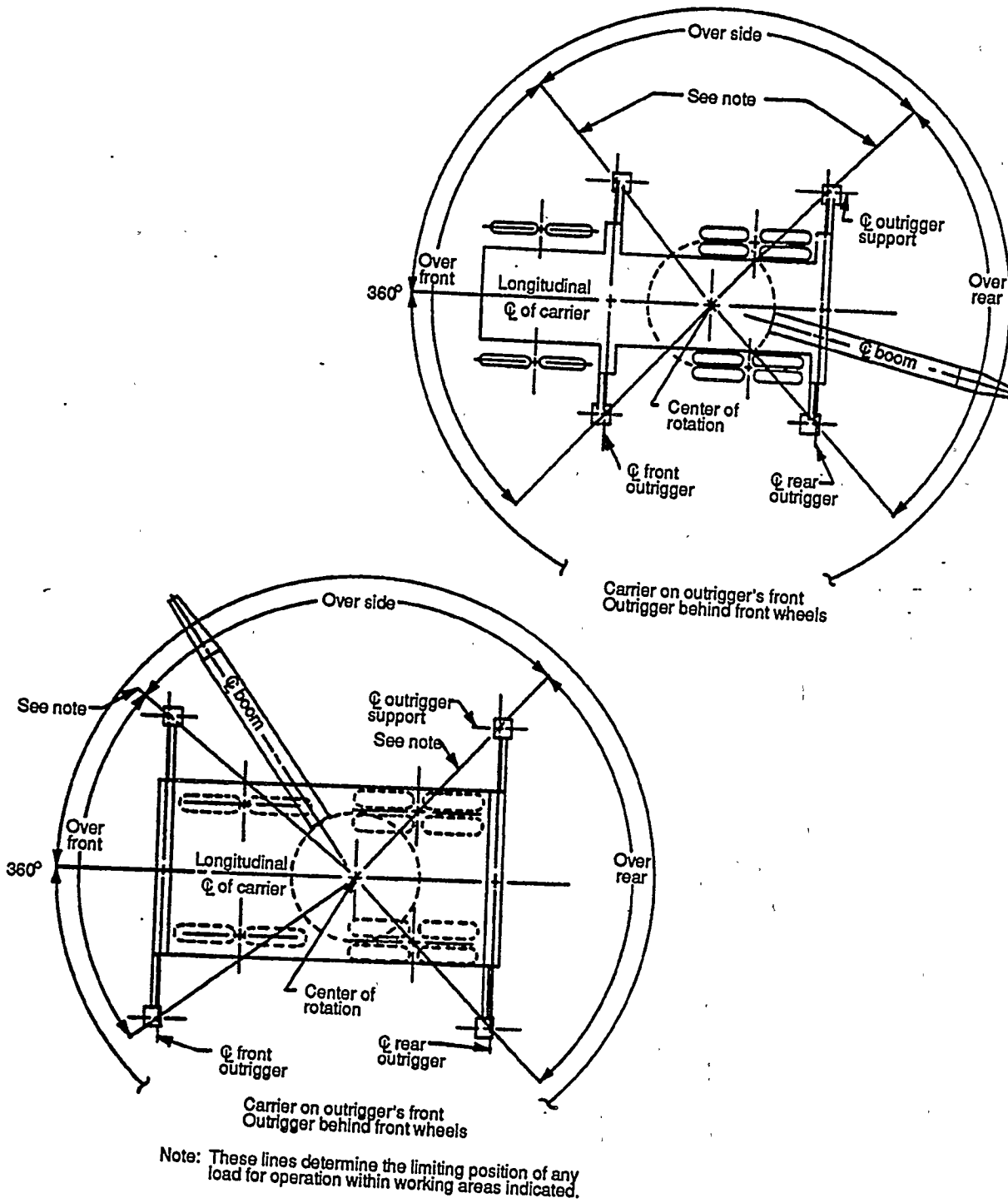

LF90-0230

Figure 4-3. Work areas for boom cranes.

DRAFT

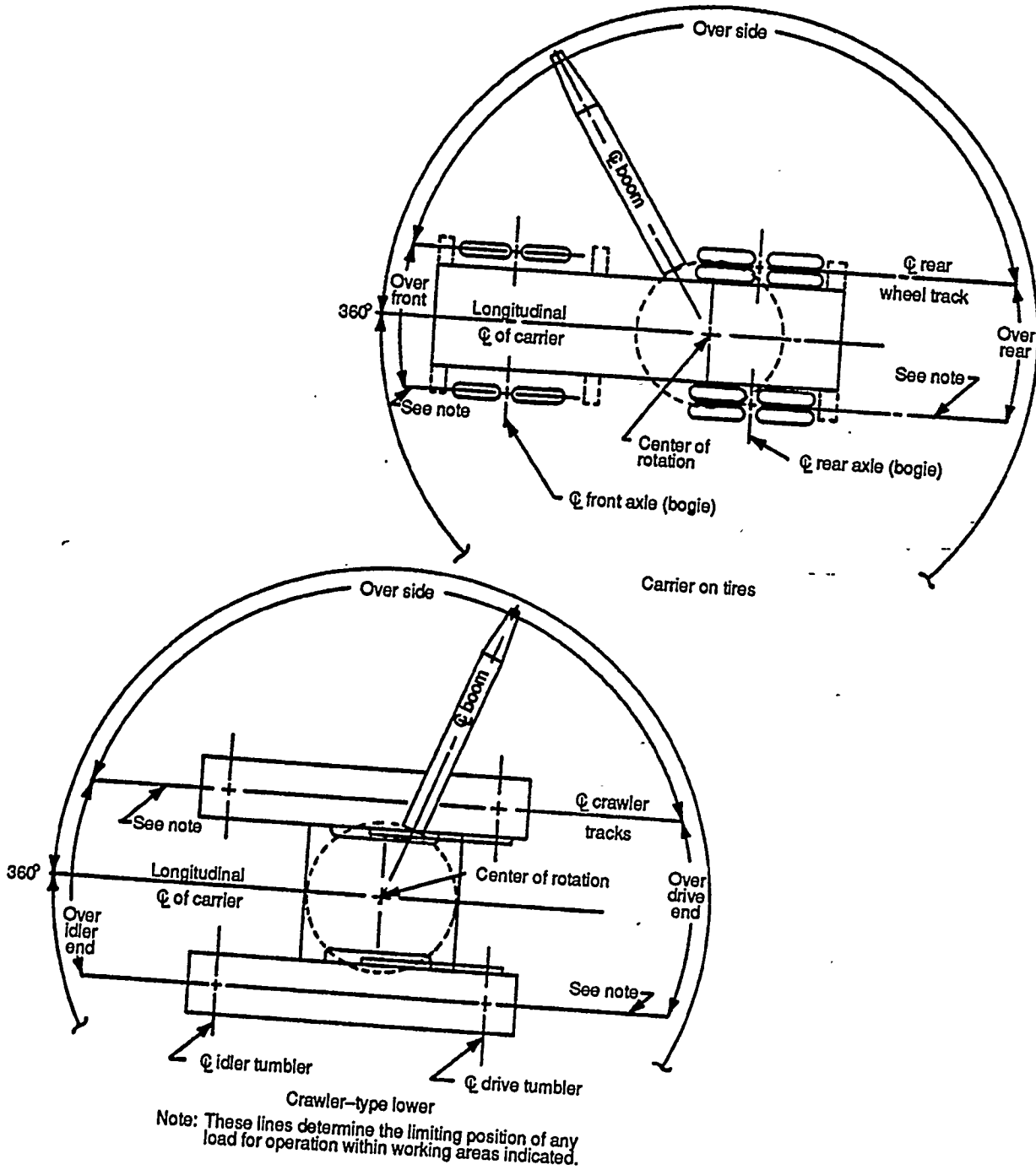

LF90-0231

Figure 4-3. (continued)

DRAFT

DEPARTMENT OF ENERGY HOISTING & RIGGING MANUAL	TITLE: MOBILE CRANES
	NUMBER: 4.0 REV: 00/91

EXHIBIT I

Page 1 of 4

PERIODIC MOBILE CRANE LOAD TEST AND INSPECTION

LICENSE OR EQUIPMENT NO. _____ MAKE _____ DATE _____
 HOUR METER-ODOMETER TOTAL _____ RATED CAPACITY _____

LOAD TEST INSPECTION REPORT

The following checklist identifies the items to be inspected prior to the load test. All inspections shall be made in accordance with the DOE Hoisting and Rigging Manual. Any unusual conditions observed during the inspection should be noted in the remarks section. Equipment shall be inspected by Program Support, maintenance personnel prior to load test.

- NOTES:**
1. NDE Inspector shall verify the inspection is completed..
 2. Load test at 100% of the manufacturer's rated capacity at any selected working radius. Load test shall not exceed 100% of manufacturer's rated capacity.
 3. Craftsmen will initial and date all tests, work, and inspections completed below.

NO.	CRANE ITEM	DEFECT	OK	NO.	CRANE ITEM	DEFECT	OK
1	Cables (Wire Rope)			13	Hoist Clutch Lining		
2	Cracked or Worn Sheaves & Drums			14	Hoist Drum Brake Bands		
3	Limit Switch (Two-Blocking)			15	Open Gears		
4	Boom			16	Boomi Jims (Where Applicable)		
5	Master Clutch			NO.	CARRIER ITEM	DEFECT	OK
6	Steering Clutches			1	Steering Gears and Connections		
7	Hydraulic Pump			2	Brakes (Service and Hand		
8	Hydraulic Controls			3	Tires and Wheels		
9	Hydraulic Hoses			4	General Lubrication		
10	Mechanical Controls				OPERATING TEST		
11	Drive Chains				OVERALL CONDITION		
12	Swing Clutches						

REMARKS (Unusual conditions, noises, Structural cracks, misalignment, etc.)

SAFETY ITEMS: (Fire Extinguisher, Signs, Guards, Etc.)

DRAFT

DEPARTMENT OF ENERGY HOISTING & RIGGING MANUAL	TITLE: MOBILE CRANES NUMBER: 4.0 REV: 00/91
---	--

EXHIBIT I (continued)

Page 2 of 4

MOBILE CRANE LOAD TEST AND FOLLOW-UP CHECKS**NOTES:** 1. Craftsman will initial all steps completed below.

2. NDE Inspector shall verify all steps below.

- _____ 1. Set crane up for load test and inspection. Load test not to exceed 100% of manufacturer's rated capacity. Refer to load chart for load test capacity at maximum and minimum working radius. Check boom angle indicators for accuracy. Check operation of all safety devices.
- _____ 2. Rig test weights to hook using appropriate slings.
- _____ 3. Static test: Hoisting equipment and winches shall be tested at maximum run out of the hoisting ropes or chain, when practical.
Equipment shall hold the test load for 10 minutes, or the time required to check all primary load-bearing parts while under strain without slippage, damage, or permanent deformation of any part of the equipment.
- _____ 4. Dynamic test: As a minimum the test load shall be raised far enough for all drums, sheaves, gears, or other rotating parts of the hoisting mechanism to complete at least one, or if possible, in clearance available, two complete revolutions; then lowered until the load comes within 2 to 3 inches of the ground; and held at this level for one minute. The hoisting cycle shall be repeated at least one more time.
At least once during the lifting portion of the hoisting cycle and once during the lowering cycle, power to the hoisting equipment shall be completely turned off. There shall be no slippage of the load or overheating of the brakes.
- _____ 5. Lower the load to approximately two inches to check for swing-roller operation and outrigger stability, slowly swing test load between outrigger locations.
- _____ 6. Move the load back into the original position and slowly lower to ground.
- _____ 7. At the completion of the load test, inspect the following:
Visually inspect rope in accordance with the DOE Hoisting and Rigging Manual, Chapter 7.

DRAFT

**DEPARTMENT OF
ENERGY
HOISTING & RIGGING
MANUAL**

TITLE: MOBILE CRANES

NUMBER: 4.0

REV: 00/91

EXHIBIT I (continued)

Page 3 of 4

MOBILE CRANE LOAD TEST AND FOLLOW-UP CHECKS

DEFECTIVE OK

- _____ a. Rope diameter: (Previous) _____ (Present) _____
- _____ b. Wear
- _____ c. Kinks
- _____ d. Broken wires
- _____ e. Other signs of deterioration

Visually inspect the rope drum for:

- _____ a. Wear
- _____ b. Deformation
- _____ c. Deterioration
- _____ d. Have NDE Inspector perform NDT test on hook by visual examination, liquid penetrant examination, or magnetic particle examination. Acceptance: No cracks, linear indications, laps, or seams.

Hooks with more than 15% normal (new hook) throat opening shall be replaced. Hooks with more than 10 degrees twist from the normal (new hook) plane of the hook shall be replaced. Hooks having more than 10% wear in the throat section or 5% elongation of the shank shall be replaced. Lubricate hooks at each inspection.

Establish three marks, A, B, and C, with a center punch. For ease in measuring, set distances on an even number of inches.

BEFORE LOAD TEST

Length AB _____ in.

Length BC _____ in.

AFTER LOAD TEST

Length AB _____ in.

Length BC _____ in.

Check for:

1. Wear and deformation
2. Cracks and twisting
3. Signs of opening between Point A and Point B

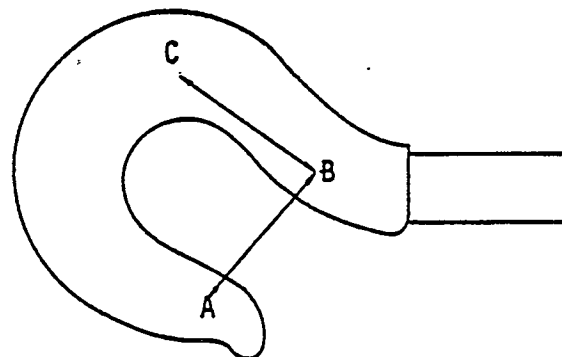

DRAFT

DEPARTMENT OF ENERGY HOISTING & RIGGING MANUAL	TITLE: MOBILE CRANES NUMBER: 4.0 REV: 00/91
---	--

EXHIBIT I (continued)

MOBILE CRANE LOAD TEST AND FOLLOW-UP CHECKS

This information should be retained with the equipment.

Record the following:

BLOCK WEIGHT _____ lbs.

TEST WEIGHT _____ lbs.

RADIUS/CENTER PIN TO LOAD _____ ft.

PARTS LINE _____ quantity

BOOM LENGTH _____ ft.

Load Test Inspection Date _____

NDE Inspector _____

Operated By _____

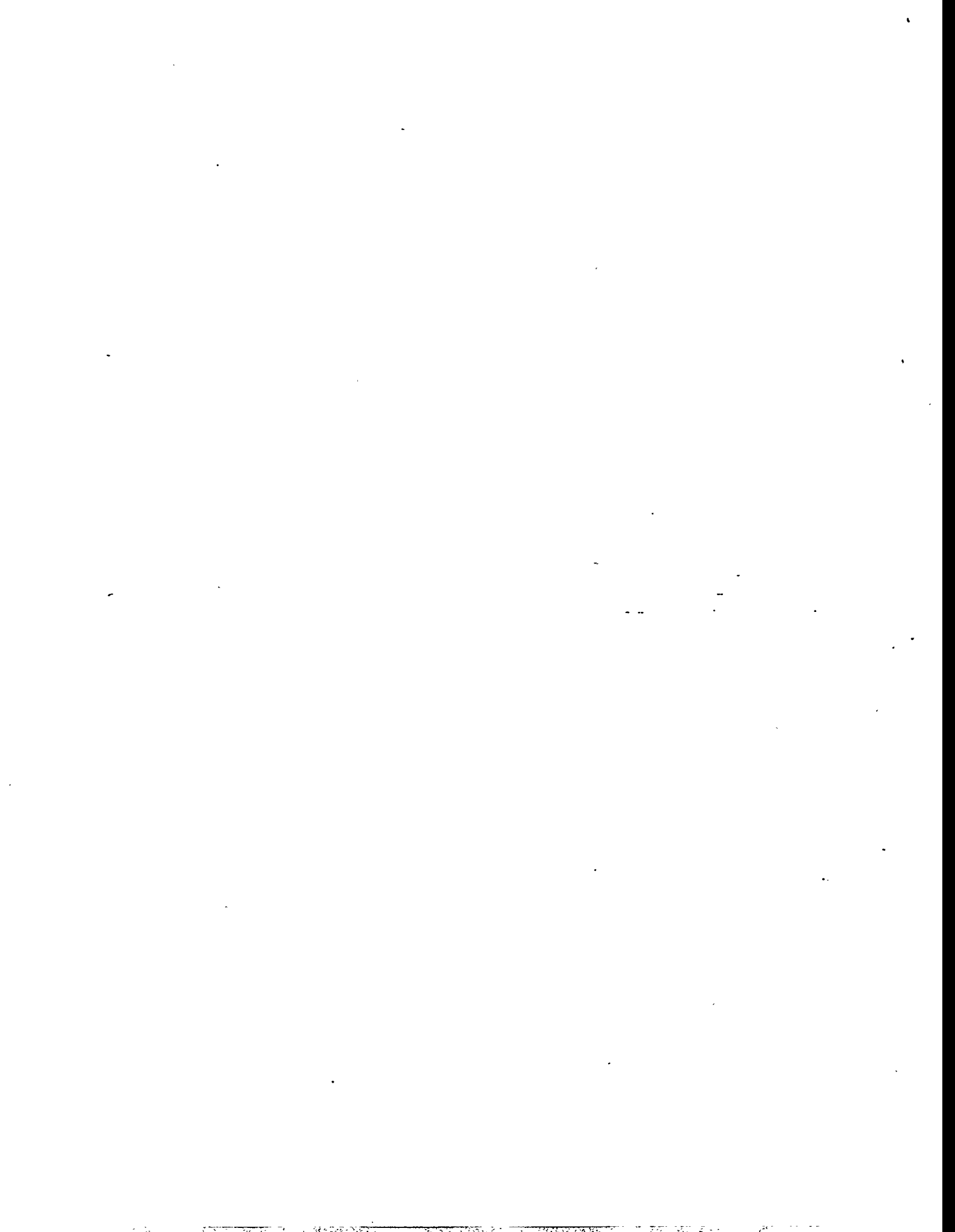

DEPARTMENT OF ENERGY HOISTING & RIGGING MANUAL	TITLE: FORKLIFT TRUCKS	REV: 00/91
	NUMBER: 5.0	

CONTENTS

5.1	General	5-1
5.1.1	Operator Training/Qualification	5-1
5.1.2	Rated Capacity	5-1
5.1.3	Truck Nameplate	5-1
5.1.4	Attachment Nameplate	5-1
5.1.5	Fire hazard Areas	5-1
5.1.6	Work Atmosphere	5-2
5.1.7	Electric-Battery-Operated Trucks	5-2
5.1.8	Internal-Combustion Trucks	5-2
5.1.9	Fork Arm	5-2
5.1.10	Design Standards	5-2
5.2	Inspection	5-2
5.2.1	Ordinary Lifts	5-2
5.2.2	High-Consequence Lifts	5-3
5.2.3	Special-High-Consequence Lifts	5-3
5.3	Testing	5-3
5.3.1	Ordinary Lifts	5-3
5.3.2	High-Consequence Lifts	5-4
5.3.3	Special-High-Consequence Lifts	5-4
5.4	Operating Practices	5-4
5.4.1	General	5-4
5.4.2	Conduct of Operator	5-4
5.4.3	Lifting Personnel	5-6
5.4.4	Standard Signals	5-6

DEPARTMENT OF ENERGY HOISTING & RIGGING MANUAL	TITLE: FORKLIFT TRUCKS NUMBER: 5.0 REV: 00/91
---	--

5.4.5	Size of Load	5-6
5.4.6	Moving the Load	5-8
5.4.7	Ordinary Lifts	5-8
5.4.8	High-Consequence Lifts	5-8
5.4.9	Special-High-Consequence Lift	5-9

FIGURES

5-1	Standard Hand Signals for Controlling Fork-Lift Operators	5-7
-----	---	-----

EXHIBIT

I	Forklift Load Test and Inspection	5-10
---	---	------

DEPARTMENT OF ENERGY HOISTING & RIGGING MANUAL	TITLE: FORKLIFT TRUCKS
	NUMBER: 5.0 REV: 00/91

5.0 FORKLIFT TRUCKS

5.1 GENERAL:

This section specifies operation, inspection, testing and maintenance requirements for the use of Forklift Trucks powered by internal combustion engines or electric motors and implements the requirements of ANSI/ASME B56.1 and B56.6, ANSI/UL 558 and 583.

5.1.1 Operator Training/Qualification

Operators of Forklift trucks shall be trained and qualified as stipulated in Section 2.0 "Operator Training and Qualification."

5.1.2 Rated Capacity

- a. Rated capacity is the maximum weight that the truck can transport and stack at a specified load center and for a specified load elevation. When originally purchased, this is usually the maximum weight, expressed in kilograms (pounds) of a 1200 mm (48 inch) homogenous cube (600 mm load center) that a truck can transport and stack to a height established by the manufacturer.
- b. Trucks shall not be used or tested above their special-rated capacities.
- c. Details are found in ANSI /ASME B56.1 (see 7.4).

5.1.3 Truck Nameplate

Every truck shall have appended to it a durable, corrosion-resistant nameplate with the model or serial number and appropriate weight of the truck legibly inscribed. The serial number shall also be stamped on the frame of the truck. The truck must be accepted by a recognized national testing laboratory and the nameplate shall be marked. The truck shall meet all other name-plate requirements of ANSI/ASME B56.1 (see Section 10.0).

5.1.4 Attachment Nameplate

Every removable attachment (excluding fork extensions) shall have installed a durable corrosion-resistant nameplate with the following information legibly and permanently inscribed:

- a. Serial Number.
- b. Weight of attachment.
- c. Rated capacity of attachment.
- d. The following instructions (or equivalent): "Capacity of truck and attachments combination may be less than capacity shown on attachment—consult truck nameplate."

5.1.5 Fire Hazard Areas

Powered industrial trucks for operation in fire hazardous areas shall be of the type as recommended in ANSI/NFPA 505.

TITLE: FORKLIFT TRUCKS

NUMBER: 5.0

REV: 00/91

5.1.6 Work Atmosphere

Concentrations of carbon monoxide, carbon dioxide, and oxygen in the work location are affected by the operation of powered industrial trucks. Concentrations of these materials in the work location must meet the requirements of OSHA (29 CFR 1910).

5.1.7 Electric-Battery-Operated Trucks

Use of electric-battery-operated trucks is restricted to those trucks that meet the requirements of ANSI/UL 583.

5.1.8 Internal-Combustion Trucks

Use of internal-combustion-powered industrial trucks is restricted to those trucks that meet the requirements of ANSI/UL 558.

5.1.9 Fork Arm

For fork lift trucks bought after December 1984, each fork arm shall be clearly stamped with its individual rated capacity in an area readily visible and not subject to wear. For example, 1500 x 24, meaning 1500 pounds (680 kilograms) capacity at 24-inch (600 mm) load center.

5.1.10 Design Standards

- a. Structural, mechanical, and electrical components shall be such that all requirements of ANSI/ASME B56.1 are met (see Section 10.0).
- b. The safety features and operation shall conform as a minimum, to the provisions of ANSI/ASME B56.1 (see Section 10.0).

5.2 INSPECTIONS:

5.2.1 Ordinary Lifts

- a. Prior to initial use, all new, altered, modified, or extensively repaired forklifts shall be inspected by a qualified inspector to assure compliance with the provisions of this Manual.
- b. Forklifts shall be inspected when assigned to service and at least once every six months thereafter by a qualified inspector. NDE of the forks shall be made at 12-month intervals. Inspection records shall be kept on file and readily available. Inspection details are given on Exhibit I, "Forklift Load Test & Inspection," which appears at the end of this Section.
- c. Brakes, steering mechanisms, control mechanisms, warning devices, lights, governors, lift-overload devices, guards, and safety devices shall be inspected regularly and maintained in a safe-operating condition.
- d. All parts of lift and tilt mechanisms and frame members shall be carefully and regularly inspected and maintained in a safe-operating condition.
- e. Special trucks or devices, designed and approved for operation in hazardous areas, shall receive special attention to ensure that the original, approved safe-operating features are preserved by maintenance.

**DEPARTMENT OF
ENERGY
HOISTING & RIGGING
MANUAL**

TITLE: FORKLIFT TRUCKS

NUMBER: 5.0

REV: 00/91

- f. Fuel systems shall be checked for leaks and condition of parts. Extra-special consideration shall be given in the case of a leak in the fuel system. Action shall be taken to prevent the use of the truck until the leak has been corrected.
- g. All hydraulic systems shall be regularly inspected and maintained in conformance with good practice. Tilt cylinders, valves, and other similar parts shall be checked to assure that "drift" has not developed to the extent that it would create a hazard.
- h. Capacity, operation, and maintenance-instruction plates, tags, or decals shall be maintained in legible condition.
- i. Batteries, motors, controllers, limit switches, protective devices, electrical conductors, and connections shall be inspected and maintained in conformance with good practice. Special attention shall be paid to the condition of electrical insulation.

5.2.2 High-Consequence Lifts

All provisions of 5.2.1 shall apply.

5.2.3 Special-High-Consequence Lifts

All provisions of 5.2.1 shall apply.

5.3 TESTING:

5.3.1 Ordinary Lifts

- a. Forklifts shall be load tested and inspected by a qualified inspector when assigned to service, and thereafter at 12-month intervals. Load test details are given on Exhibit I, "Forklift Load Test and Inspection Report," which appears at the end of this Section. Load test records shall be kept on file and readily available to appointed personnel.
- b. The load tests required in a. above shall not exceed the rated capacity of the equipment. Test weights shall be accurate to within -5%, +0% of stipulated values. Load slippage for this equipment shall not be greater than a maximum of 3 in. vertically and 1 in. horizontally at the cylinder during a static test period of at least 10 min. in duration.
- c. If a test has not been completed by the end of the required period, the equipment shall be downrated as follows:
 - (1) Thirty calendar days after the end of the period, the equipment shall be downrated to 75% of the rated capacity.
 - (2) Sixty calendar days after the end of the period, the equipment shall be downrated to 50% of the rated capacity.
 - (3) Ninety calendar days after the end of the period, the equipment shall be taken out of service until the required inspection has been completed.

DRAFT

**DEPARTMENT OF
ENERGY
HOISTING & RIGGING
MANUAL****TITLE: FORKLIFT TRUCKS****NUMBER: 5.0****REV: 00/91****5.3.2 High-Consequence Lifts**

- a. All provisions of 5.3.1 shall apply.

5.3.3 Special-High-Consequence Lifts

- a. Forklifts shall be load tested when assigned to this service and at six-month intervals thereafter or prior to making a Special-High-Consequence Lift. Load test details are given on Exhibit I, "Forklift Load Test and Inspection Report," which appears at the end of this Section.
- b. All provisions of 5.3.1b and c shall apply.

5.4 OPERATING PRACTICES:**5.4.1 General**

- a. An appointed person shall classify each lift into one of the DOE categories prior to planning the lift.
- b. The operator shall not engage in any practice which will divert attention while operating the forklift.
- c. The operator shall not operate the forklift when physically or mentally incapacitated.
- d. The operating area shall be kept free of water, snow, ice, oil, and debris that could cause the operators hands and feet to slip from the controls.
- e. Special consideration should be given to the proper functioning of tires, horn, lights, battery, brakes, steering mechanisms, and operating controls. If at any time a forklift is in need of repair, defective, or is in any way unsafe, the matter shall be reported immediately to the designated authority. The unit shall be taken out of service until it has been restored to safe-operating condition or a determination has been made by the cognizant manager that the discrepancy will not adversely affect the safe operation of the unit.
- f. A 5BC, or larger, fire extinguisher shall be installed on the forklift and shall be maintained in a serviceable condition.

5.4.2 Conduct of Operator

- a. Before operation of electric powered machines, check location of the battery plug for quick disconnection in case of a short circuit.
- b. Avoid sudden stops.
- c. Face in the direction of travel, except as follows:
 1. For better vision with large loads, operate the truck in reverse gear.
 2. Do not descend ramps with load in front.

DRAFT

**DEPARTMENT OF
ENERGY
HOISTING & RIGGING
MANUAL****TITLE: FORKLIFT TRUCKS****NUMBER: 5.0****REV: 00/91**

- d. Watch blind corners and stop at all intersections and doorways, and sound the horn.
- e. Operate at safe speeds: in-plant buildings—5 mph; in-plant roads—15 mph maximum.
- f. Go slow around curves.
- g. Use low gear or slowest-speed control when descending ramps.
- h. Riders are prohibited on powered industrial trucks, unless the truck is specifically built with passenger seating.
- i. Know the rated capacity of the truck and stay within it.
- j. Consider both truck and load weight.
- k. Watch overhead clearance. If in doubt, measure.
- l. Keep clear of edge of the loading dock.
- m. Watch rear-end swing.
- n. Before handling, assure that stacks and loads are stable. Block and lash them if necessary.
- o. Always spread the forks to suit the load width.
- p. Lower and raise the load slowly. Make smooth gradual stops.
- q. Lift and lower loads only while the vehicle is stopped.
- r. Use special care when high-tiering. Return the lift to a vertical position before lowering load.
- s. Lift, lower, and carry loads with the upright vertical or tilted back; never forward.
- t. To avoid personal injury, keep arms and legs inside the operator's area of the machine.
- u. Never travel with forks raised to unnecessary heights. Approximately 4 to 6 inches above floor level is adequate.
- v. When loading trucks or trailers, see that the wheels are chocked and the brakes set. Operate in front end of the semitrailer only if the tractor is attached, or adequate trailer (railroad) jacks are in place.
- w. Inspect floors on trucks, boxcars, unfamiliar ramps, or platforms before start of operation.
- x. Be sure bridge plates into trucks or freight cars are sufficiently wide, strong, and secure.
- y. Never butt loads with forks or rear end of truck.
- z. Fork trucks should not be used as tow trucks. They are built for lifting only, unless a towing hitch is supplied by the manufacturer. Use tow bars rather than cable for towing.
- aa. Stop engine before refueling.

DRAFT

**DEPARTMENT OF
ENERGY
HOISTING & RIGGING
MANUAL**

TITLE: FORKLIFT TRUCKS

NUMBER: 5.0

REV: 00/91

- bb. Use only approved explosion-proof lights to check gas tank and battery water levels. Smoking is not permitted during this operation.
- cc. Place forks flat on the floor when truck is parked.
- dd. Turn switch key off when leaving the machine.
- ee. Always set brakes before leaving the truck.
- ff. Report evidence of faulty truck performance.
- gg. When alighting from truck, step down—do not jump.
- hh. Report all accidents promptly to your Supervisor.
- ii. The final responsibility for the handling of a truck remains with the driver. Use guides and signalers as much as possible. If in doubt, check personally before proceeding.
- jj. Never lift with one tine without an engineering analysis and approval.

5.4.3 Lifting Personnel

- a. No lifting or lowering shall be done while a worker is on the tines, load, or manlift platform attached to the forklift tines except as stipulated in 3.15.6. The forklift shall not travel while personnel are on the platform.
- b. When being supported by a forklift, the manlift platform shall be attached in such a manner that it cannot inadvertently slide or bounce off the tines.

5.4.4 Standard Signals

- a. Standard hand signals for use at DOE locations shall be as specified in the latest edition of the American National Standards Institute (ANSI) chapters, for the particular forklift being used. (See Figure 5-1).
- b. The operator shall recognize signals from the designated signaler only except that a signal for STOP shall be obeyed no matter who gives it.

5.4.5 Size of Load

- a. Since the load rating for forklifts may be based on stability, or hydraulic or structural competence, the rated capacity shall not be exceeded in operational application.
- b. No forklift shall be loaded beyond the special-rated capacity.
- c. The designated person shall ascertain that the weight of a load approaching the special-rated capacity (combination of weight and location of the center of gravity) has been determined within +10% before it is lifted.

DRAFT

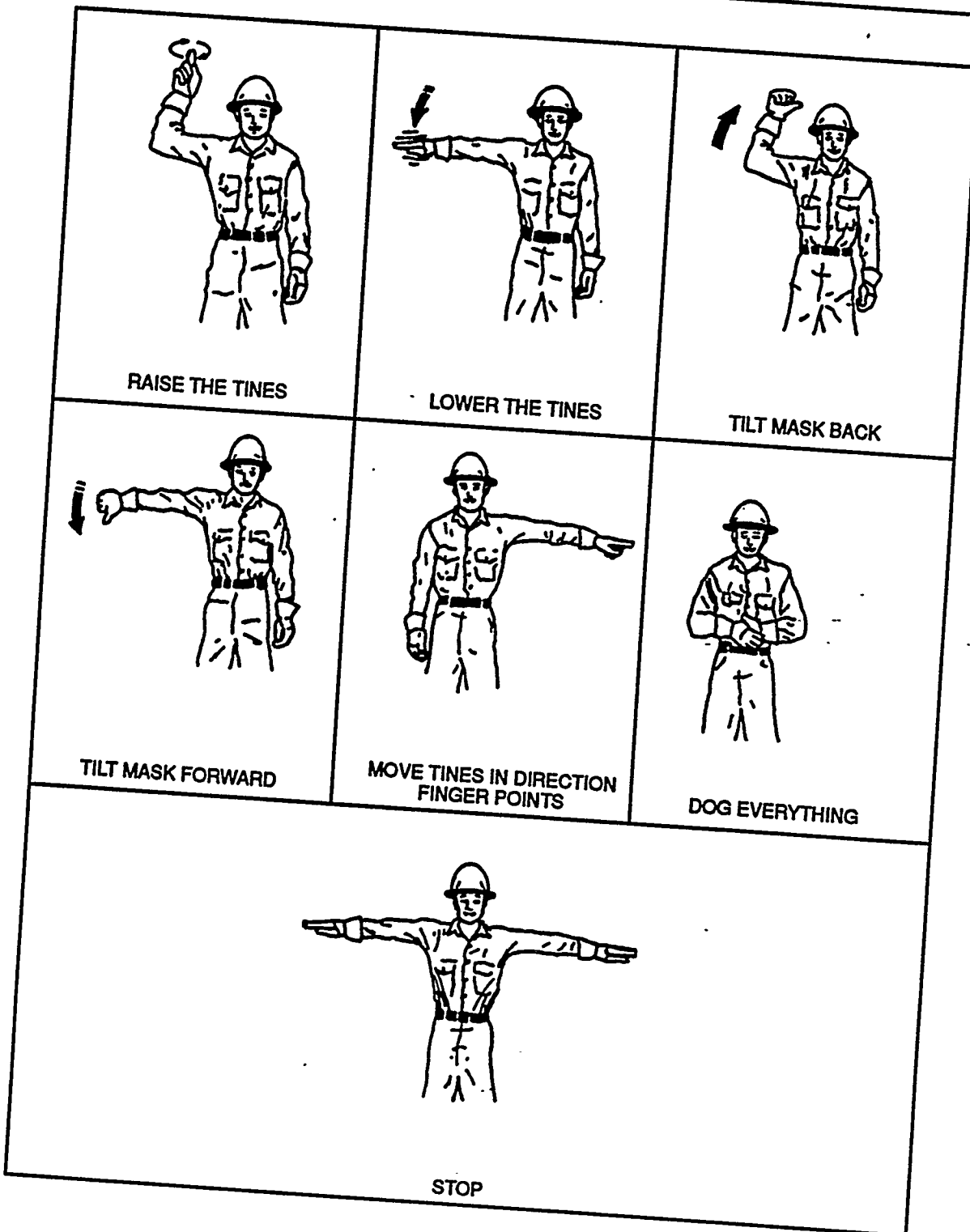

LF90-0130

Figure 5-1. Standard Hand Signals for Controlling Fork-Lift Operators

DRAFT

5.4.6 Moving the Load

- a. The nature of the terrain, or surface upon which the truck is to operate, is a very important factor in the stability of load-truck system. The designated person shall assure that a proper truck has been selected to operate on the surface available. In general, small, three-wheeled trucks are to be operated on smooth, hard surfaces only, and are not suitable for outdoor work.
- b. The designated person shall assure that the load is well secured and properly balanced before it is lifted.
- c. During hoisting, care should be taken that:
 - (1) There is no sudden acceleration of the load.
 - (2) The load does not contact any obstruction.

5.4.7 Ordinary Lifts

The provisions of 5.4.1 through 5.4.6 shall apply.

5.4.8 High-Consequence Lifts

- a. The provisions of 5.4.1 through 5.4.6 shall apply.
- b. The operating organization shall appoint one person in charge (PIC) of the entire lifting operation. This person shall meet the definitions of appointed, designated, and qualified, as set forth in Section 1.0.
- c. The PIC shall assure that a work plan is prepared covering the entire lifting operation. Consideration of the lift history of the truck shall affect the plan, which shall also include, but is not limited to, inspection and test-certification periods, load configuration, and the presence of hazardous materials. The plan must be reviewed and approved by the cognizant Safety organization.
- d. When two or more trucks are required to lift or handle a load, one qualified specialist shall be assigned who shall analyze the operation, instruct all personnel in the proper positioning and rigging of the load and use of the equipment, and direct the operation of all equipment.
- e. Load tests will not be conducted in locations such that they meet the definitions of High-Consequence Lifts in Section 1.0.
- f. The PIC shall be a Qualified Person, or shall be assisted by a Qualified Person, experienced in using hoisting and rigging equipment of the type to be used; preparing and reviewing drawings, procedures, and equipment assignments; and supervising the job.
- g. Only Qualified Operators may be assigned to operate the lifting equipment. Designated signalers shall give signals to the operator when required due to the nature of the lift.
- h. Generalized procedures may be submitted for the handling of these loads, except when detailed procedures are specified. Individual procedures for several similar items are not required unless specified. Procedures shall include identification of the item or class of items

to be moved, the type of equipment and rigging accessories to be used and their special-rated capacity, any special instructions for operation, and provision for verification by the authorized person that the lift or move has been satisfactorily completed. The PIC shall certify that good rigging practices, precautions, and safety measures will be employed; the equipment operators are qualified and have been properly instructed; and that equipment is adequate for the loads involved and is in good operating condition.

5.4.9 Special-High-Consequence Lift

- a. All of 5.4.8 shall apply.
- b. In addition to those items previously required, the work plan required in 5.4.8c shall include, as a minimum, the following:
 - (1) Identification of each piece of operating equipment to be used in the move by type, rated or special-rated capacity, and, for other than permanently installed equipment, the equipment serial number or other identifying number. (If the specific piece of nonpermanent equipment has not been identified at the time of procedure specification, the number shall be included in the job instructions prepared by the appointed person.)
 - (2) Identification of accessories or assemblies by serial number and weight. (If the specific items have not been identified at the time of procedure preparation, they shall be identified in the job instructions prepared by the appointed person.)
 - (3) A list of all nonserialized rigging accessories and materials required in the move or lift, identified by type, capacity, and weight.
 - (4) Identification of the item to be moved, its weight, dimensions, and center of gravity.
 - (5) Sketches showing special attachments, lifting fixtures, accessories, methods of attachment, and other factors affecting the capacity of equipment and accessories used in the move, together with notation of limitations to be applied on any allowable orientation of the operating equipment or rigging accessories to be used.
 - (6) Instructions to be given to equipment operators, including sequence of equipment moves and coordinations with moves of other equipment involved; translational speeds, directions, and distances, load weight, center of gravity, and other pertinent data.
 - (7) Identification of persons who will have field responsibility for the move or lift and for monitoring it.
 - (8) Requirements for specific tests to be made before, during, and after the move or lift, including a load test for Special-High-Consequences Loads or a practice lift.
 - (9) Surveillance procedures, including check points, instruments, and indicators, that will be used to ensure that the move is proceeding according to plan and the special-rated capacity of the equipment has not been exceeded.
 - (10) Provision for verification by the PIC, or his/her designee, of the satisfactory completion of each step of the procedure as it occurs.

DEPARTMENT OF ENERGY HOISTING & RIGGING MANUAL	TITLE: FORKLIFT TRUCKS	
	NUMBER: 5.0	REV: 00/91

EXHIBIT I

Page 1 of 2

FORKLIFT LOAD TEST AND INSPECTION

INSPECTED BY _____ EQUIPMENT NUMBER _____

LOCATION _____ DATE _____

INSPECTION: Craftsmen will initial all tests, work, and inspections completion below.

Prior to initial use, all new, altered, modified, or extensively repaired forklifts shall be inspected.

Forklifts shall be inspected when assigned to service and at least every six months thereafter.

NDE Inspector shall verify inspection complete prior to load test.

All inspections shall be in accordance with DOE Hoisting and Rigging Manual.

**CRAFTSMAN
INITIAL**

- | | |
|-------|---|
| _____ | 1. Insure capacity, operation, and maintenance—instruction plates, tags, or decals are legible. |
| _____ | 2. Check all hydraulic systems including tilt cylinders, valves, and other similar parts to assure “drift” has not developed. |
| _____ | 3. Check fuel system for leaks and condition of parts. Special consideration shall be given in the case of a leak in the fuel system. Immediate action shall be taken to put the forklift “out of service” until the leak is corrected. |
| _____ | 4. Check all parts of lift and tilt mechanisms and frame members to insure safe operating conditions, such as, but not limited to, hoist chain for damage and excessive wear. |
| _____ | 5. Check for proper tire inflation (where applicable). Check tires being secured properly and level with each other. |
| _____ | 6. Check batteries, motors, controllers, limit switches, protective devices, electrical conductors and connections, special attention shall be paid to the condition of electrical insulation. |
| _____ | 7. Check brakes, steering mechanisms, warning devices, lights, governors, lift overload devices, guards, and safety devices. |

QUALITY

NDE Inspector shall use the criteria for Items 8, 9, and 10 and perform visual examination, liquid penetrant examination, or mag. particle examination.

Acceptance: No cracks, linear indications, laps, or seams.

- | | |
|-------|---|
| _____ | 8. Check for tines being secured properly and level with each other. |
| _____ | 9. NDE Inspector performs NDT Test on the right angle joint of the fork once every 12 months. |
| _____ | 10. NDE Inspector performs NDT Test on the load or stress bearing welds that attach the tines to the forklift once every 12 months. |

DRAFT

**DEPARTMENT OF
ENERGY
TESTING & RIGGING
MANUAL**

TITLE: FORKLIFT TRUCKS

NUMBER: 5.0

REV: 00/91

EXHIBIT I (continued)

Page 2 of 2

FORKLIFT LOAD TEST

TEST

- TEST:**
1. Read all steps below prior to load test.
 2. Forklifts shall be load tested when assigned to service and thereafter at 12-month intervals.
 3. Load test forklift at 100% rated capacity. Load test shall not exceed 100% of the special-rated capacity of the equipment.
 4. Forklifts assigned to special-high-consequence service shall be load tested at 6-month intervals, and before making a special-high-consequence lift.

INSPECTOR: Shall verify all steps below.

TEST NUMBER _____ **EQUIPMENT OPERATOR (Actual Load Test** _____ **lbs.**

Quality Verify (Load Test) _____ **Date** _____

Weight _____

1. Set forklift on solid, level ground.
2. Perform load test using the required weight (see Note 3).

Static-Forklift trucks shall demonstrate ability to withstand the appropriate test load for a period of at least ten minutes without permanent deformation or apparent damage. Load slippage for this equipment shall not be greater than a maximum of 3 inches vertically and 1 inch horizontally at the cylinder.

3. Check system for leaks while undergoing test.

DRAFT

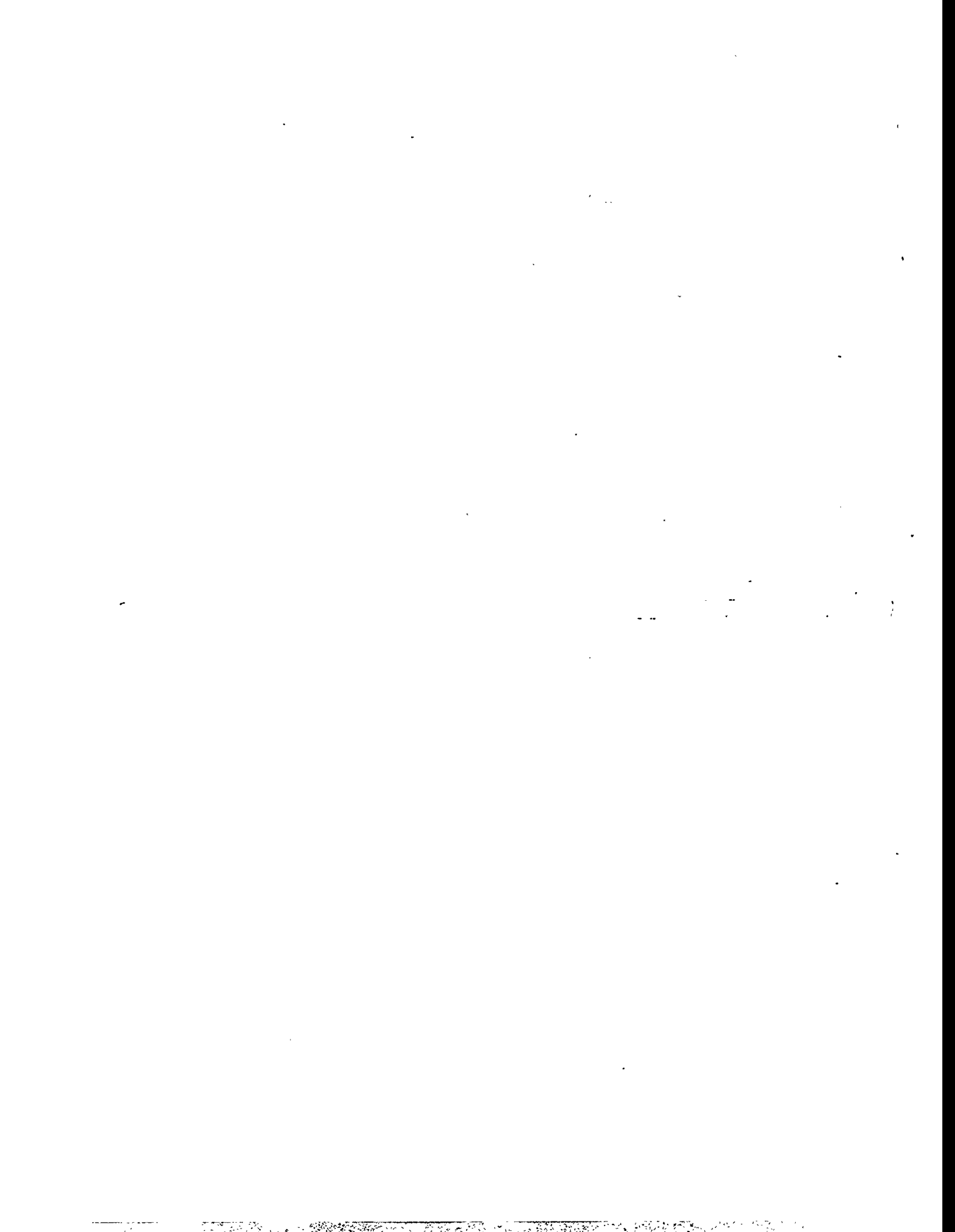

CONTENTS

6.1	General	6-1
6.1.1	Operator Training/Qualification	6-1
6.1.2	Marking	6-1
6.1.3	Load Chain	6-1
6.1.4	Load Breaking	6-1
6.1.5	Location	6-1
6.1.6	Support	6-1
6.1.7	Load Rating	6-1
6.1.8	Design Standards	6-1
6.2	Inspections	6-5
6.2.1	Ordinary Lifts	6-5
6.2.2	High-Consequence Lifts	6-8
6.2.3	Special-High-Consequence Lifts	6-9
6.3	Testing	6-9
6.3.1	Ordinary Lifts	6-9
6.3.2	High-Consequence Lifts	6-10
6.3.3	Special-High-Consequence Lifts	6-10
6.4	Operating Practices	6-10
6.4.1	Conduct of Operator	6-10
6.4.2	Size of Load	6-11
6.4.3	Attaching the Load	6-11
6.4.4	Moving the Load	6-11
6.4.5	Hoist Limit Switch	6-12
6.4.6	Ordinary Lifts	6-12

DEPARTMENT OF ENERGY HOISTING & RIGGING MANUAL	TITLE: HOISTS NUMBER: 6.0	REV: 00/91
---	--	-------------------

6.4.7 High-Consequence Lifts 6-12

6.4.8 Special-High-Consequence Lift 6-13

FIGURES

6-1 Hand Chain Operates Chain Hoists 6-2

6-2 Electric/Air-Powered Chain and Wire Rope Hoists 6-3

6-3 Electric/Air-Powered Wire Rope Hoists 6-4

EXHIBIT

I Hoist Load Test and Inspection 6-15

DEPARTMENT OF ENERGY HOISTING & RIGGING MANUAL	TITLE: HOISTS NUMBER: 6.0 REV: 00/91
---	---

6.0 HOISTS

6.1 GENERAL:

This section establishes safety standards for the operation, inspection, testing, and design of electric-powered, air-powered, or hand-powered hoists not permanently mounted on overhead crane and implements the requirements of ANSI/ASME B30.16. (See Figure 6-1 through 6-3).

6.1.1 Operator Training/Qualification

Operators of hoists shall be trained and qualified as stipulated in Section 2.0, "Operator training and Qualification."

6.1.2 Marking

- a. The special-rated capacity shall be permanently marked on the hoist or load block and shall be clearly legible from the operating position.
- b. The hoist shall be permanently marked with the manufacturer's name, address, and unit identification.

6.1.3 Load Chain

- a. Load chains shall be proof-tested by the chain or hoist manufacturer with a load at least one-and-one-half times the rated load, divided by the number of chain parts supporting the load.
- b. Wrought-iron chain is not permitted for load line.
- c. Roller chain is not permitted for load line.

6.1.4 Load Braking

The hoist shall be so designed that, when the actuating force is removed, it will automatically stop and hold the load up to 125% of the special-rated capacity.

6.1.5 Location

The hoist shall be installed only in locations that will permit the operator to stand free of the load at all times.

6.1.6 Support

Support structure, including trolleys, monorail, crane, if any, shall have a special-rated capacity at least equal to that of the hoist.

6.1.7 Load Rating

The special-rated capacity shall not be exceeded except for properly authorized tests.

1.8 Design Standards

- a. The safety features and operation shall conform, as a minimum, to the provisions of ANSI B30.16 (see Section 10.0).
- b. Electrically powered chain hoists shall comply with ANSI/ASME HST-1M.

DEPARTMENT OF
ENERGY
HOISTING & RIGGING
MANUAL

TITLE: HOISTS

NUMBER: 6.0

REV: 00/91

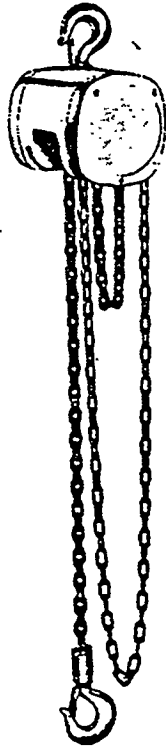

HAND CHAIN OPERATED CHAIN HOIST

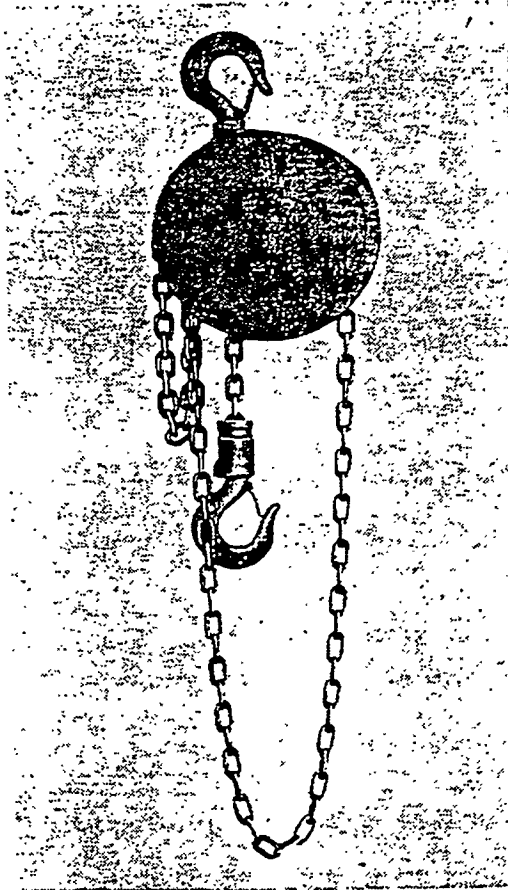

HAND CHAIN OPERATED CHAIN HOIST

FIGURE 6-1 Hand Chain Operated Chain Hoists

DRAFT

DEPARTMENT OF ENERGY HOISTING & RIGGING MANUAL	TITLE: HOISTS	REV: 00/91
	NUMBER: 6.0	

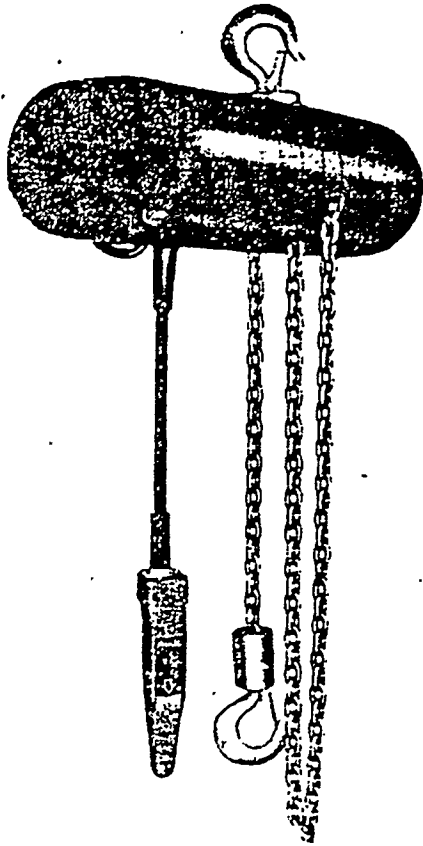

ELECTRIC POWERED CHAIN HOIST



AIR POWERED CHAIN HOIST

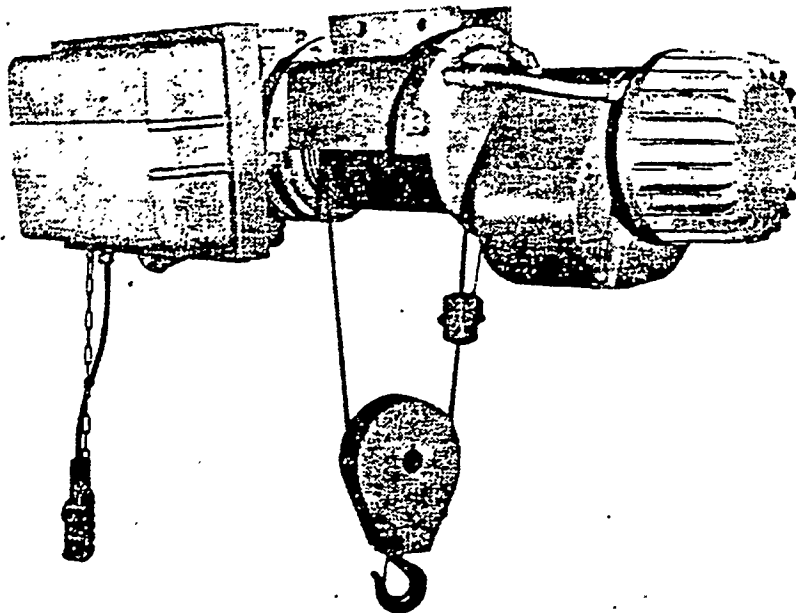
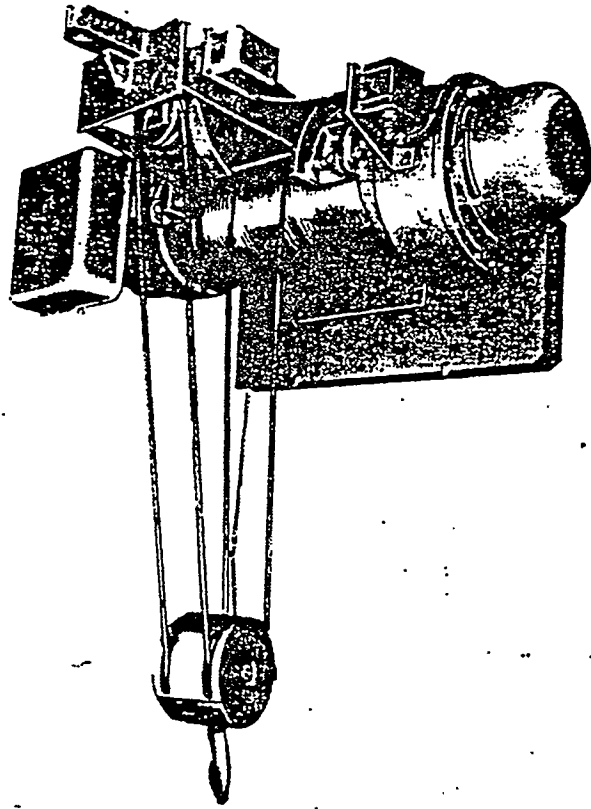

FIGURE 6-2 Electric/Air-Powered Chain and Wire Rope Hoists

DEPARTMENT OF ENERGY HOISTING & RIGGING MANUAL	TITLE: HOISTS NUMBER: 6.0 REV: 00/91
---	---



ELECTRIC POWERED WIRE ROPE HOIST

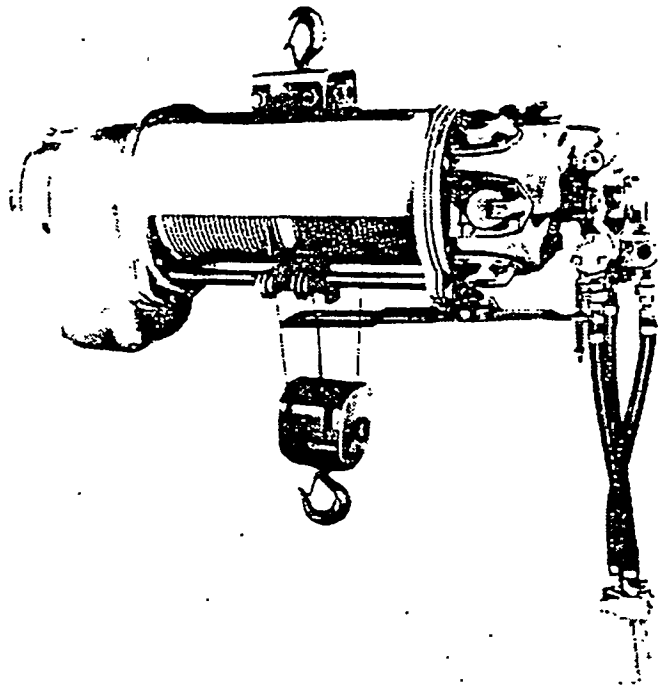

FIGURE 6-3 Electric/Air-Powered Wire Rope Hoists

DEPARTMENT OF ENERGY HOISTING & RIGGING MANUAL	TITLE: HOISTS NUMBER: 6.0 REV: 00/91
---	---

6.2 INSPECTIONS:

6.2.1 Ordinary Lifts

- a. All new hoists shall be inspected by the hoist manufacturer. Prior to initial use, all altered or repaired hoists shall be inspected by, or under the direction of, a certified inspector whose qualification to perform specific activities has been determined, verified and attested to in writing to ensure compliance with the provisions of this Section.
- b. Inspection procedures for hoists in regular use are divided into two general classifications, based upon the intervals at which the inspection should be performed by or under the direction of a certified inspector whose qualification has been determined, verified and attested to in writing. The intervals, in turn, are dependent upon the nature of the critical components of the hoist, and the degree of their exposure to wear, deterioration, or malfunction. The general classifications are herein designated as "frequent" and "periodic," with respective intervals between inspections as defined below:
 - (1) Frequent inspection: daily to monthly intervals
 - (2) Periodic inspection: 1- to 12-month intervals, or as specified by the manufacturer. Hoists exposed to adverse environments should receive periodic inspections more frequently.
- c. Frequent Inspections: Items, such as the following, shall be inspected for damage at intervals as defined in 6.2.1.b(1), or as otherwise established, including observation during operation to detect any damage which might appear between regular inspections. Deficiencies shall be carefully examined, and determinations shall be made as to whether they constitute safety hazards.
 - (1) All controls and operating mechanisms for improper operation: daily or before use.
 - (2) All safety devices for malfunction: daily or before use.
 - (3) Deterioration or leakage in air systems: daily or before use
 - (4) Hooks damaged from chemicals, deformation, cracks, or having more than 15% in excess of normal throat opening, or more than 10-degrees twist from the plane of the unbent hook. NOTE: Any hook that is twisted or has a throat opening in excess of normal indicates abuse or overloading of the unit. Other load-bearing components of the hoist should be inspected for damage—daily or before use.
 - (5) Load-carrying ropes or chains: Visual inspection shall be made daily for wear, twist, distortion, or improper dead-ending to the hoisting drum and other attachments. Chains shall also be inspected for deposits of foreign material, which may be carried into the hoist mechanism.
- d. Periodic Inspections: Complete inspections of the hoist shall be performed at intervals as generally defined in 6.2.1.b(2) above, depending upon the unit's activity, severity of service, and environment; or as specifically indicated below. These inspections shall include the requirements of 6.2.1.c above and, in addition, items such as those listed below. Any deficiencies, such as those listed, shall be carefully examined, and determinations shall be made as to whether they constitute a safety hazard. Inspection records shall be kept on file and readily available.

Items for inspection are included in EXHIBIT I, "Hoist Load Test and Inspection," which appears at the end of this Section.

DRAFT

**DEPARTMENT OF
ENERGY
HOISTING & RIGGING
MANUAL**

TITLE: HOISTS

NUMBER: 6.0

REV: 00/91

- (1) Loose bolts or rivets
 - (2) Cracked or worn drums or sheaves
 - (3) Worn, corroded, cracked, or distorted parts such as pins, bearings, shafts, gears, rollers locking, and clamping devices
 - (4) Excessive wear on motors or load brakes
 - (5) Excessive wear of chains, ropes, load sprockets, drums, sheaves, and chain stretch
 - (6) Hooks: Dye penetrants, magnetic particle, or other suitable crack-detecting inspections should be performed at least once per year
 - (7) Electrical apparatus for signs of pitting or any deterioration of controller contractors, limit switches, and push-button switches
 - (8) Hook retaining nuts or collars and pins, welds, or riveting used to secure the retaining members
 - (9) Supporting structures and trolleys, if used, shall be inspected for continued ability to support the imposed loads
 - (10) Warning labels for absence or illegibility.
- e. Semiannual inspections, complete with written, dated and signed reports, shall be conducted on critical items, i.e., brakes, hooks, chains, and load lines. Inspection records shall be kept on file and readily available.
- f. All running ropes shall be visually inspected by the operator or an appointed person once each shift or prior to use if the hoist is not in regular service. A thorough inspection of all ropes shall be made by a qualified inspector at least once every six months or prior to use if the hoist is not in regular service. Written, dated, and signed inspection reports shall be kept on file and readily available to appointed personnel. Any deterioration, resulting in appreciable loss of original strength such as described below, shall be carefully noted, and determinations shall be made as to whether further use of the rope constitutes an acceptable risk.
- (1) Reduction of rope diameter below nominal whether due to loss of core support, internal or external corrosion, or wear of outside wires
 - (2) A number of broken outside wires and the degree, distribution, or concentration of such broken wires
 - (3) Worn outside wires
 - (4) Sections of rope which are normally hidden during inspection or maintenance procedures, such as parts passing over sheaves, should be given close inspection as these are points most subject to deterioration
 - (5) Corroded or broken wires at end connections

DRAFT

DEPARTMENT OF ENERGY HOISTING & RIGGING MANUAL	TITLE: HOISTS NUMBER: 6.0 REV: 00/91
---	---

- (6) Corroded, cracked, bent, worn or improperly applied end connections
- (7) Kinking, crushing, cutting, or unstranding.
- g. All rope, which has been idle for a month or more due to shutdown or storage of a hoist on which it is installed, shall be given a thorough inspection before it is placed in service. This inspection shall be for all types of deteriorations, and shall be performed by an appointed or designated person whose approval shall be required before further use of the rope. A written and dated report of the rope condition shall be filed.
- h. No precise rules can be given for determination of exact time for replacement of rope, since many variables are involved. Safety in this respect depends largely upon the use of good judgment by an appointed or designated person in evaluating remaining strength in a used rope, after allowance for deterioration disclosed by inspection. Safety of rope operation depends upon this remaining strength.
- i. Conditions, such as the following, shall be sufficient reason for questioning rope safety and consideration of replacement:
 - (1) In hoist ropes, 12 randomly distributed broken wires in one rope lay, or 3 broken wires in one strand in one rope lay
 - (2) Wear of one-third of the original diameter of outside individual wires
 - (3) Kinking, crushing, birdcaging, or any other damage resulting in distortion of the rope structure
 - (4) Evidence of any heat damage from any cause
 - (5) Reductions from nominal diameter of more than 0.4 mm (1/64 inch) for diameters up to and including 7.9 mm (5/16 inch), 0.8 mm (1/32 inch) for diameters 9.5 mm (3/8 inch) to and including 12.7 mm (1/2 inch), 1.2 mm (3/64 inch) for diameters 14.3 mm (9/16 inch) to and including 19.1 mm (3/4 inch), 1.6 mm (1/16 inch) for diameters 22.2 mm (7/8 inch) to and including 28.6 mm (1-1/8 inch), and 2.4 mm (3/32 inch) for diameters 31.8 mm (1-1/4 inch) to and including 38.1 mm (1-1/2 inch).
- j. In order to establish data as a basis for judging the proper time for replacement, an inspection record shall be maintained.
- k. Special attention shall be given to end fastenings. Ropes should be examined frequently at socketed fittings; upon the development of two broken wires adjacent to this point, the rope should be resocketed or replaced. Resocketing shall not be attempted if the resulting rope length will be insufficient for proper operation. Those portions of the rope subjected to reverse bends and operation over small-diameter drums or sheaves should be given close attention.
- l. Replacement rope shall be the same size, grade, and construction as the original rope furnished by the hoist manufacturer, unless otherwise recommended by a rope manufacturer due to actual working conditions.
- m. Chain
 - (1) Operate the hoist under load in hoisting and lowering directions, and observe the operation of the chain and sprockets. The chain should feed smoothly into and away from the sprockets.

DEPARTMENT OF ENERGY HOISTING & RIGGING MANUAL	TITLE: HOISTS NUMBER: 6.0 REV: 00/91
---	---

- (2) If the chain binds, jumps, or is noisy, first see that it is clean and properly lubricated. If the trouble persists, inspect the chain and mating parts for wear, distortion, or other damage.
- (3) Chain should be cleaned for inspection. Examine visually for gouges, nicks, weld splatter, corrosion, and distorted links. Slacken the chain and move adjacent links to one side to inspect for wear at the contact points. If wear is observed or stretching is suspected, the chain should be measured according to the hoist manufacturer's instructions. If instructions are not available, proceed as follows.
 - (a) Select an unworn, unstretched length of the chain (e.g., at the slack end)
 - (b) Suspend the chain vertically under tension and, using a caliper-type gauge, measure the outside length of any convenient number of links approximately 12 to 14 inches overall
 - (c) Measure the same number of links in the used sections and calculate the percentage increase in length.

n. Replacement

- (a) If the used chain exceeds a hoist manufacturer's recommended length, or in the absence of such a recommendation, if the used chain is 1-1/2% longer than unused chain, replace the chain. Repairing the load chain by welding or any other means shall not be attempted by anyone other than the chain manufacturer.
- (b) The existence of gouges, nicks, corrosion, weld splatter, or distorted links is sufficient reason for questioning chain safety and considering chain replacement. Safety in this respect depends largely upon the use of good judgment by an appointed or designated person in evaluating the degree of damage.
- (c) Replacement chain shall be the same size, grade, and construction as the original chain furnished by the hoist manufacturer, unless otherwise recommended by the hoist manufacturer due to actual working condition.
- (d) Load-chain links which pass over the hoist-load sprocket on edge (alternate to those which lie flat in the pockets) should be installed with the welds away from the center of the sprocket. This precaution is not required on idler sprockets, which change the direction but not the tension in the chain.
- (e) The chain shall be installed without any twist between the hoist and an anchored end on either the loaded side or the slack side.
- (f) When a chain is replaced, disassemble and inspect the mating parts (sprockets, guides, stripper) for wear, and replace if necessary.

6.2.2 High-Consequence Lifts

- a. All provisions of 7.1.4a shall apply.
- b. Equipment shall be inspected when assigned to this service and at 12 month intervals thereafter. Major inspection shall include all points and items covered by the equipment

DRAFT

DEPARTMENT OF ENERGY HOISTING & RIGGING MANUAL	TITLE: HOISTS	
	NUMBER: 6.0	REV: 00/91

manufacturer's recommendations (when available). Periodic inspection in accordance with 7.1.4a(4), nondestructive examination (magnetic particle or liquid penetrant) of hooks and, when required by the inspector, welds, bearings, or other suspect load-bearing parts shall be done at specified intervals. NDE shall be in accordance with pertinent sections of applicable ASTM Standards. Annual maintenance shall be carried out prior to or during the major inspection. Items for inspection are included in Exhibit IV, "Hoist Load Test & Inspection," which appears at the end of Section 7.0 of this Manual.

6.2.3 Special-High Consequence Lifts

All provisions of 6.2.2 shall apply.

6.3 TESTING:

6.3.1 Ordinary Lifts

- a. All hoists in which load-sustaining parts have been altered, replaced, or repaired shall be tested and inspected by a qualified inspector and a written report confirming the load rating shall be filed and readily available. Test loads shall be at 125% of the rated capacity.
- b. On hoists incorporating overload devices which prevent the lifting of 125% of the rated load, a load test shall be accomplished with at least 100% of rated load, after which the function of the overload device shall be tested.
- c. The trip setting of limit switches and limiting devices shall be conducted first by hand if practical; then under slowest speed obtainable; and then with increasing speeds up to maximum speed. Actuating mechanisms shall be located so that they will trip the switches or limiting devices in sufficient time to stop motion without damage to any part of the hoisting arrangement.
- d. All anchorages and/or suspensions shall be approved by the appointed person.
- e. Hoists shall be tested before use by, or under the direction of, a designated person to ensure compliance with this standard, including the following functions: hoisting and lowering, operation of brakes, limit devices, locking, and safety devices.
- f. Permanently installed hoists shall be load tested when assigned to this service, thereafter at 3 year intervals, and when specified in the procedures, except that temporarily installed, portable units i.e., chain falls shall be tested annually. In no case shall the load test exceed the rated capacity of the equipment. Test weights shall be accurate to within -5%, +0% of stipulated values. Load tests shall be performed by a qualified inspector and load test records shall be kept on file and readily available.
- g. If a test has not been completed by the end of the required period, the equipment shall be downrated as follows:
 - (1) Thirty calendar days after the end of the period, the equipment shall be downrated to 75% of the rated capacity.
 - (2) Sixty calendar days after the end of the period, the equipment shall be downrated to 50% of the rated capacity.

DRAFT

DEPARTMENT OF ENERGY HOISTING & RIGGING MANUAL	TITLE: HOISTS NUMBER: 6.0 REV: 00/91
---	---

- (3) Ninety calendar days after the end of the period, the equipment shall be taken out of service until the required inspection has been completed.

6.3.2 High-Consequence Lifts

All provisions of 6.3.1 shall apply.

Once the hoist has been put in service, load tests shall be made with a hook load of 125% of the combined weight of the item to be lifted and the lifting tackle, or with a hook load of 125% of the rated capacity; in no case shall the load test exceed 125% of rated capacity of the equipment. Test weights shall be accurate within -5%, +0% of stipulated values.

6.3.3 Special-High-Consequence Lifts

- a. All provisions of 7.2.4(b) shall apply. The following shall apply:

- (1) **Static Test:** Equipment shall hold the test load for 10 minutes, or the time required to check all primary load-bearing parts while under strain without slippage, damage, or permanent deformation of any part of the equipment. Hoisting equipment and winches shall be tested in maximum run-out of the hoisting ropes or chain, when practical.
- (2) **Dynamic Test:** Hoisting equipment shall be operated through at least two complete cycles of all movements which the equipment will encounter in service, while supporting the test load. As a minimum, the test load shall be raised far enough for all drums, sheaves, gears, or other rotating parts of the hoisting mechanism to complete at least one or, if possible in the clearance available, two complete revolutions; then lowered until the load comes within 2 or 3 in. of the ground; and held at this level for one minute. The hoisting cycle shall be repeated at least one more time. Tests shall be made by the operator who normally operates the equipment, who shall demonstrate his/her ability to positively control the load during all lateral, rotational, and vertical motions which will be encountered in service. At least once during the lifting portion of the hoisting cycle and once during the lowering cycle, power to the hoisting equipment shall be completely turned off. There shall be no slippage of the load or overheating of the brakes.

6.4 OPERATING PRACTICES:

6.4.1 Conduct of Operator

- a. The operator shall not engage in any practice which will divert his/her attention while engaged in operating the hoist.
- b. Before starting the hoist, the operator shall be certain that all personnel are clear of the equipment.
- c. The operator shall familiarize himself/herself with the equipment and its proper care. If adjustments or repairs are necessary or any damage is known or suspected, the operator shall report it promptly to the appointed person. The operator shall also notify the next operator of the problem upon changing shifts.
- d. All controls shall be tested by the operator before beginning a shift. If any controls do not operate properly, they shall be adjusted or repaired before operations begin.

DRAFT

**DEPARTMENT OF
ENERGY
HOISTING & RIGGING
MANUAL**TITLE: **HOISTS**NUMBER: **6.0**REV: **00/91**

- e. Before operating a hoist, make sure hands are clear from all moving parts.
- f. Take signals from only one person using the standard signs shown in Section 3.0, Figure 3-5. A stop signal shall be obeyed regardless of who gives it.

6.4.2 Size of Load

The hoist shall not be loaded beyond the special-rated capacity, except for authorized testing.

6.4.3 Attaching the Load:

- a. The hoisting rope or chain shall not be wrapped around the load.
- b. The load shall be attached to the hook by means of slings or other approved devices.
- c. The slings or other approved devices shall be seated properly in the saddle of the hook before hoisting operations are carried out.

6.4.4 Moving the Load:

- a. The load shall not be moved or lifted more than a few inches until it is well balanced in a sling or lifting device.
- b. Care shall be taken in hoisting to be certain that:
 - (1) Hoist ropes or chains are not kinked or twisted.
 - (2) The load does not contact any obstructions.
 - (3) Multiple-part ropes or chains are not twisted around each other.
- c. Before starting to hoist, the rope or chain shall be properly seated on the drum, sheaves, or sprockets.
- d. Hoists shall not be operated until the hoist unit is centered over the load, except when specifically authorized by an appointed person who has determined that the components of the hoist and its mounting will not be overstressed.
- e. A hoist shall not be used for handling personnel unless specifically recommended for such use by the manufacturer, and so indicated on a permanent nameplate attached to the hoist. Installations-handling personnel shall meet the requirements of Section 3.15.6.
- f. The operator shall avoid carrying loads over people.
- g. The operator shall test the brakes each time a load approaching the rated load is handled by raising the load just enough to clear the floor or supports, and checking for brake action. The lift shall be continued only after the operator is assured that the braking system is operating properly.
- h. No loaded hoist drum shall be rotated in the lowering direction beyond the point where less than two wraps of rope remain in the drum.

DRAFT

**DEPARTMENT OF
ENERGY
HOISTING & RIGGING
MANUAL**

TITLE: HOISTS

NUMBER: 6.0

REV: 00/91

- i. The operator shall inch the hoist into engagement with a load, and avoid unnecessary stops and starts.
- j. A tag line shall be used if it becomes necessary to guide, snub, or otherwise control the load.

6.4.5 Hoist-Limit Switch

- a. At the beginning of a shift, the operator shall try out the upper-limit switch of each hoist under no load. Extreme care shall be exercised; the block shall be "inched" into the limit or run in at slow speed. If the switch does not operate properly, the designated person shall be notified immediately.
- b. If a lift is in progress during a shift change, this testing requirement is considered to have been satisfied for the completion of that lift. However, the limit switch must be tested again before the next lift.
- c. The hoist-limit switch which controls the upper limit of travel of the load block shall never be used as an operating control.

6.4.6 Ordinary Lifts

- a. The provisions 6.4.1 through 6.4.5 shall apply.
- b. All hoists shall be inspected by a designated person to assure that the special-rated capacity will not be exceeded, and that they are still within the test-certification period.
- c. All lifting devices shall be inspected by a designated person to assure that the special-rated capacity of each item will not be exceeded, and that they are still within the test-certification period, if appropriate.
- d. The operator, or other designated person, shall visually examine the hoist (records are not required except as noted) in accordance with the requirements for a frequent inspection as stipulated in 6.2.1c. above.
- e. Any deficiencies shall be carefully examined by a qualified person, and a determination as to whether they constitute a hazard. These deficiencies shall be corrected prior to operating the hoist.
- f. An appointed person shall classify each lift into one of the DOE categories before the lift is planned.
- g. Load lines shall be checked after strain is put on them, before the load is lifted clear of the ground. If not plumb, the slings or equipment shall be repositioned so that the lines are plumb before continuing.

6.4.7 High-Consequence Lifts

- a. All of 6.4.6 shall apply.
- b. The operating organization shall appoint one person in charge (PIC) of the entire lifting operation. This person shall meet the definitions of appointed, designated, and qualified, as set forth in Section 1.0.

DRAFT

DEPARTMENT OF ENERGY HOISTING & RIGGING MANUAL	TITLE: HOISTS	
	NUMBER: 6.0	REV: 00/91

- c. The PIC shall assure that a work plan is prepared covering the entire lifting operation. Consideration of the lift history of the hoist shall affect the plan, which shall also include, but is not limited to, sling angles and sizes; inspection and test–certification periods; load configuration; the presence of hazardous materials; and the requirement for a load–indicating device. The plan must be reviewed and approved by the cognizant Safety organization.
- d. When the weight of the lift is within 10% of the special–rated capacity, and equipment of greater capacity is not available, the PIC shall review, in detail, the positioning and rigging of the load with the person who will carry out the lift. The effect of ground conditions, wind and weather on the stability of the equipment, and the effect of rotational and translational speeds shall be considered in giving instructions to equipment operators.
- e. Hoisting shall be stopped when the load is approximately 2 inches off the supports, and a check made to determine any tendency to swing or sway, and any tendency of slings to slip or change position. Sling positions shall be adjusted or additional supports or restraints shall be added as necessary before continuing the lift. Procedural approval of changes to sling position, supports, and restraints shall be obtained from the PIC before they are made.
- f. Load tests will not be conducted in locations such that they meet the definition of High–Consequence Lifts in Section 1.0.
- g. The PIC shall be a Qualified Person, or shall be assisted by a Qualified Person, experienced in using hoisting and rigging equipment of the type to be used; preparing and reviewing drawings, procedures, and equipment assignments; and supervising the job.
- h. Generalized procedures may be submitted for the handling of these loads, except when detailed procedures are specified. Individual procedures for several similar items are not required unless specified. Procedures shall include identification of the item or class of items to be used and their special–rated capacities, any special instructions to operators, and provisions for verification by the authorized person that the lift or move has been satisfactorily completed. The PIC shall certify that good rigging precautions, practices, and safety measures will be employed; that equipment operators are qualified and have been properly instructed; and that equipment is adequate for the loads involved and in good operating condition.

6.4.8 Special–High–Consequence Lifts

- a. All of 6.4.7 shall apply.
- b. In addition to those items previously required, the work plan required in 6.4.7c shall include, as a minimum, the following:
 - (1) Identification of each piece of operating equipment to be used in the move by type, rated and special–rated capacity and, for other than permanently installed equipment, the equipment serial number or other identifying number. (If the specific piece of nonpermanent equipment has not been identified at the time of procedure specification, the number shall be included in the job instructions prepared by the appointed person.)
 - (2) Identification of slings, lifting bars, and other major rigging accessories or assemblies, by serial number.

DEPARTMENT OF ENERGY HOISTING & RIGGING MANUAL	TITLE: HOISTS NUMBER: 6.0 REV: 00/91
---	---

(If the specific items have not been identified at the time of procedure preparation, they shall be identified in the job instructions prepared by the appointed person.)

- (3) A list of all nonserialized rigging accessories and materials required in the move or lift, identified by type and capacity.
- (4) Identification of the item to be moved, its weight, dimensions, and center of gravity (as determined by the method of SAE J874, or estimated from drawings or engineering analysis), and the total hook load.
- (5) Rigging sketches showing all lifting points, load vectors, sling angles, accessories, methods of attachment, and other factors affecting the capacity of equipment and limitations to be applied.
- (6) Approximate and maximum hoist and winching speeds.
- (7) Instructions to be given to operators, including the sequence of equipment moves and coordination with moves of other equipment involved; translational speeds, directions, and distances; load weight and center of gravity; and other pertinent data.
- (8) Identification of persons who will have field responsibility for the move or lift and for monitoring it.
- (9) Requirements for specific tests to be made before, during, and after the move or lift, including load tests for Special-High-Consequence Loads or practice lifts.
- (10) Surveillance procedures, including check points, instruments, and indicators, that will be used to ensure that the move is proceeding according to plan, and the special-rated capacity of the equipment has not been exceeded.
- (11) Provisions for verification by the PIC, or his/her designee, of satisfactory completion of each step of the procedure as it occurs.

DEPARTMENT OF ENERGY HOISTING & RIGGING MANUAL	TITLE: HOISTS	
	NUMBER: 6.0	REV: 00/91

EXHIBIT IV

Page 1 of 2

LOAD TEST AND INSPECTION

INSPECTED BY _____ QUALITY _____
 HOIST ID# _____ LOCATION _____ DATE _____

- NOTES:**
1. Load test at 100% of manufacturer's rated capacity/load test shall not exceed 100% of manufacturer's rated capacity. Test weights shall be accurate to within -5%, +0% of stipulated values.
 2. NDE Inspector shall verify all steps as listed below.
 3. Craftsmen will initial all tests, work, and inspections completed below.
 4. All inspections shall be in accordance with DOE Hoisting and Rigging Manual.

-
- _____ 1. Perform the annual PM inspection: Check unit for proper operation.
 - _____ 2. **MANUAL HOISTS ONLY:** Check brake mechanism for work, glazed, or contaminated disks, worn pawls, cams, or ratchet. Check for broken, corroded, or stretched pawl springs. Repair as needed.
 - _____ 3. **ELECTRIC POWERED HOISTS:** Check for:
 - a. All functional operating mechanisms for misadjustment interfering with proper operation.
 - b. Limit switches or devices for proper operation.
 - c. External evidence of damage or excessive wear of load sprockets, idler sprockets, and drums or sheaves.
 - d. External evidence of wear on motor or load brake.
 - e. Electrical apparatus for signs of pitting or any deterioration of visible controller contacts.
 - f. All anchorage or hoist suspensions.
 - _____ 4. Set hoist up for load test and inspection. Where applicable insure that the load chart is legible.
 - _____ 5. Perform load test using the required test weights (see Note 1) and appropriate slings. Measure a length of the load chain under tension; measure a length of 15 links. If wire rope is used measure the diameter. Inspect chain and/or wire rope in accordance with the DOE Hoisting and Rigging Manual, Chapter 7.

IF HOIST IS EQUIPPED WITH A TROLLEY:

- _____ 1. Mount hoist on a monorail.
- _____ 2. Rig test weight to load hook (See #4 above).
- _____ 3. Perform load test moving weight along monorail. Observe hoist and trolley. Observe performance of all load bearing components.
- _____ 4. Lower test weight to floor. Note performance of hoist during lowering operation; remove rigging.

DRAFT

DEPARTMENT OF ENERGY HOISTING & RIGGING MANUAL	TITLE: HOISTS	
	NUMBER: 6.0	REV: 00/91

EXHIBIT IV (continued)

HOIST LOAD TEST AND INSPECTION

At the completion of the load test, inspect the following items.

1. Visually inspect and remeasure the load chain and/or hoist rope after the load test. Check for deformed or broken links, stretch, and etc.
2. Inspect load hook and suspension hook for bend or twist.

<u>LOAD HOOK:</u>		<u>PREVIOUS</u>	<u>PRESENT</u>
NDE Inspector Verify _____	Throat Opening:	_____	_____
NDE Inspector Verify _____	Hook Twist:	_____	_____
<u>SUSPENSION HOOK:</u>			
NDE Inspector Verify _____	Throat Opening:	_____	_____
NDE Inspector Verify _____	Hook Twist:	_____	_____

NDE Inspector perform NDT test on hook by visual examination, liquid penetrant examination, or mag. particle examination.

Acceptance: No cracks, linear indications, laps, or seams.

Hooks with more than 15% normal (new hook) throat opening shall be replaced. Hooks with more than 10 degrees twist from the normal (new hook) plane of the hook, shall be replaced. Hooks having more than 10% wear in the throat section or 5% elongation of the shank shall be replaced. Lubricate hooks at each inspection.

Establish three marks, A, B, and C, with a center punch. For ease in measuring, set distances on an even number of inches.

BEFORE LOAD TEST

Length AB _____ in.
Length BC _____ in.

AFTER LOAD TEST

Length AB _____ in.
Length BC _____ in.

Check for:

1. Wear and deformation
2. Cracks and twisting
3. Signs of opening between Point A and Point B

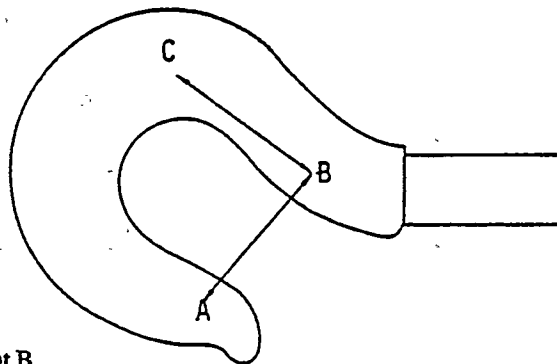

Equipment Operator _____

Actual Load Test _____ lbs. Quality Verify Load Test _____ Date _____

DEPARTMENT OF ENERGY HOISTING & RIGGING MANUAL	TITLE: HOOKS NUMBER: 7.0	REV: 00/91
---	---	-------------------

CONTENTS

7.1	General	7-1
7.1.1	Marking	7-1
7.1.2	Attachments	7-1
7.1.3	Load Limits	7-1
7.1.4	Design Standards	7-1
7.2	Inspections	7-2
7.2.1	Ordinary Lifts	7-2
7.2.2	High-Consequence Lifts	7-2
7.2.3	Special-High-Consequence Lifts	7-3
7.3	Testing	7-3
7.4	Maintenance	7-5
7.5	Operating Practices	7-5
7.5.1	Conduct of User	7-5

TABLES

7-1	Proof Test Load	7-4
------------	------------------------------	------------

DEPARTMENT OF ENERGY HOISTING & RIGGING MANUAL	TITLE: HOOKS NUMBER: 7.0	REV: 00/91
---	---	-------------------

7.0 HOOKS

7.1 GENERAL:

This section establishes safety standards for the design, operation, inspection, testing, and maintenance of load hooks installed on cranes or hoists and implements the requirements of ANSI/ASME B30.10, Chapter 10-1, "Hooks." (See Section 8.0, for rigging hook requirements).

7.1.1 Marking

The manufacturer's identification should be forged, cast, or die stamped on a low-stress and non-wearing area of the hook.

7.1.2 Attachments

- a. Hoisting hooks shall be fitted with a latch to bridge the throat opening to prevent the accidental release of slings or attachments. Hooks without latches may be used in special applications where the latch interferes with the proper use of the hook, providing 1) that the application for which it is approved, and 2) that in questionable cases, concurrence is obtained from the appropriate safety organization.
- b. With the concurrence of the cognizant safety organization, the requirements of a., above, may be waived for remotely operated cranes.
- c. If a handle or latch support is welded to the hook whose design requires heat treating, welding shall be done prior to final heat treating.

7.1.3 Load Limits

- a. Hooks shall not be loaded beyond special-rated capacity except for load tests of the equipment of which they are a part, or for Planned Engineered Lifts, as provided in Section 3.9.2.

7.1.4 Design Standards

- a. Hook design shall meet generally accepted hook design standards, and be compatible with the requirements of ANSI B30.10, "Hooks." For hooks up to 60 tons, such design shall include a minimum design factor of 5, based on the ultimate strength of the material used. For hooks 60 tons and over, use the manufacturer's standard.
- b. The hook material shall have sufficient ductility to permanently deform before failure at the temperature at which the hook will be used.
- c. When a latch is provided, it shall be designed to retain such items as slings under slick conditions. The latch is not intended to support the load.
- d. For High-Consequence Lifts, or Special-High-Consequence Lifts, single hooks shall be forged from carbon steel having a tensile strength between 56,000 and 66,000 psi in the normalized condition, or alloy steel meeting the requirements of 3.6.5b. Flow lines of the forging shall follow the axis of the hook and shank. Duplex and multi-prong hooks may be either cast or machined from steel or alloy steel meeting the above requirements.
- e. The bearing surfaces of new hooks shall be the arc of a circle, and gauge points, or hook gauges, for measuring spread after load testing shall be provided.

DEPARTMENT OF ENERGY HOISTING & RIGGING MANUAL	TITLE: HOOKS NUMBER: 7.0	REV: 00/91
---	--	--------------------

- f. Field-fabricated hooks are prohibited, except as may be specifically approved by the cognizant safety organization.

7.2 INSPECTIONS:

7.2.1 Ordinary Lifts

- a. Visual inspection – every three months by a qualified inspector whose qualifications to perform specific inspection activities has been determined, verified and attested to in writing.
- b. NDE in accordance with applicable ASTM standards annually. If the NDE has not been completed by the end of the required period, hooks shall be downrated as follows:
- (1) Thirty calendar days after the end of the period, the equipment shall be downrated to 75% of the rated capacity.
 - (2) Sixty calendar days after the end of the period, the equipment shall be downrated to 50% of the rated capacity.
 - (3) Ninety calendar days after the end of the period, the equipment shall be taken out of service until the required NDE has been completed.
- c. Hooks have any of the following deficiencies shall be removed from service, unless a qualified person approves their continued limit use:
- (1) Crack(s)
 - (2) Wear exceeding 10% of the original dimension
 - (3) A bend or twist exceeding 10 degrees from the plane of the unbent hook
 - (4) Increase in throat opening exceeding 15% from the new condition
 - (5) If a latch is provided, and it becomes inoperative because of wear or deformation, or fails to fully bridge the throat opening, the hook shall be removed from service until the device has been repaired or replaced; or the throat opening has been assessed per (4) above.
 - (6) If hooks are painted, a visual inspection should take the coating into consideration. Surface variations can disclose evidence of heavy or severe service. The surface condition may then call for stripping the paint in such instances.
 - (7) Reports of all inspections shall be maintained. Records should include item identification, characteristics inspected, observations, disposition if any, and date of actions. Records shall be kept readily available for inspection by designated personnel.
- d. Refer to Exhibit VIII, "Rigging, Tackle, Accessories, Load Test & Inspection (Hooks, Shackles, Rings, etc.) which appears at the end of Section 7.0 in this manual.

7.2.2 High-Consequence Lifts

- a. All provisions of 7.2.1 shall apply.

DRAFT

DEPARTMENT OF ENERGY HOISTING & RIGGING MANUAL	TITLE: HOOKS NUMBER: 7.0 REV: 00/91
---	--

7.2.3 Special-High-Consequence Lifts

- a. All provisions of 7.2.2 shall apply.
- b. Visual inspections shall be conducted monthly.

7.3 TESTING:

- 7.3.1** Each hook of 150-tons capacity, and larger, and a prototype of each hook design of less than 150-tons capacity shall be proof-tested by the manufacturer in accordance with Table 7-1.
- 7.3.2** When proof tests are used, the hooks shall withstand the proof load application without permanent deformation when the load is applied for a minimum of 15 seconds. This condition shall be considered to have been satisfied if the permanent increase in the throat opening does not exceed 0.5% for 0.01 in. (0.25 mm), whichever is greater.
- 7.3.3** For a duplex (sister) hook having a pin eye, the proof load for the eye shall be in accordance with Table 7-1. The proof load shall be shared equally between the two prongs of a sister hook, unless designed for unbalanced loading.
- 7.3.4** Hooks which have been proof-tested shall be inspected by the magnetic-particle method in accordance with ASTM E709, and shall show no cracks, inclusions, or other relevant discrepancies; castings shall be evaluated in accordance with ASTM E125.
- 7.3.5** No performance testing of hooks shall be required, except as is necessary to conform to the requirements for the equipment of which they are a part.

DEPARTMENT OF ENERGY HOISTING & RIGGING MANUAL	TITLE: HOOKS
	NUMBER: 7.0 REV: 00/91

Table 7--1. Proof test load

Rated Load		Percent of R/L	Proof Load (Minimum)	
Tons (2000 lbs)	kg		Tons (2000 lbs)	kg
0.50	453.6	200	1	8.9
1	907.2	200	2	17.8
5	4,536	200	10	89
10	9,072	200	20	178
15	13,608	200	30	267
20	18,144	200	40	356
25	22,680	200	50	445
30	27,216	200	60	534
35	31,752	200	70	626
40	36,288	200	80	712
45	40,824	200	90	801
50	45,360	200	100	890
60	54,432	193	116	1032.5
75	68,040	183	137	1219
100	90,720	166	166	1477
125	113,400	150	188	1673
150	136,080	133	200	178
175	158,760	133	233	2074
200	181,440	133	266	2367
250	226,800	133	333	2964
300	272,160	133	399	3551
350	317,520	133	465	4139
400	362,880	133	532	4735
450	408,240	133	598	5322
500	453,600	133	665	5919

Above 500 453,600 133

Note: 1 ton (short, 2000 lbs) = 907.2 kg

For hooks with rated load ratings not shown in the above table, use the next lower rated load rating for determining the percent of rated load to be applied as excess load.

DRAFT

DEPARTMENT OF ENERGY HOISTING & RIGGING MANUAL	TITLE: HOOKS NUMBER: 7.0 REV: 00/91
---	--

7.4 MAINTENANCE:

- 7.4.1** A hook latch that is inoperative or missing shall be replaced.
- 7.4.2** A hook with a latch that does not close the throat opening shall be removed from service or moused until the latch is replaced or repaired.
- 7.4.3** Repair of cracks, nicks, and gouges shall be carried out by a designated person by grinding longitudinally, following the contour of the hook, provided no dimension is reduced more than 10% (or as recommended by the manufacturer) of its original value.
- 7.4.4** All other repairs shall be performed by the manufacturer or a qualified person.

7.5 OPERATING PRACTICES:

7.5.1 Conduct of User

- a. Determine that the weight of the load to be lifted does not exceed the load rating of the hook.
- b. Shock loading shall be avoided.
- c. Load shall be centered in the base (bowl-saddle) of the hook to prevent point loading of the hook.
- d. Hooks shall not be used in such a manner as to place a side or backload on the hook
- e. When using a device to bridge the throat openings of the hook, care shall be used that no portion of the load is carried by the bridging device.
- f. Hands and fingers shall be kept from between the hook and the load.
- g. Duplex (sister) hooks shall be loaded equally on both sides, unless the hook is specifically designed for single loading.
- h. The pin hole in Duplex (sister) hooks shall not be loaded beyond the rated load of the hook.

DEPARTMENT OF ENERGY HOISTING & RIGGING MANUAL	TITLE: WIRE ROPE, SLINGS, & RIGGING ACCESSORIES NUMBER: 8.0 REV: 00/91
---	---

CONTENTS

8.1	General	1
8.2	Wire Rope	3
8.2.1	Wire-Rope Lays	3
8.2.2	Wire-Rope For General Purpose	6
8.2.3	Wire-Rope Maintenance	12
8.3	Slings	12
8.3.1	General	12
8.3.2	Safe Load	17
8.3.3	Factor of Safety	17
8.3.4	Sling Care	17
8.3.5	Sling Storage	17
8.3.6	Wire-Rope Slings	18
8.3.7	Steel-Chain Slings	34
8.3.8	Metal-Mesh Slings	41
8.3.9	Synthetic-Mesh Slings	46
8.4	Rigging Hooks	57
8.4.1	Design	57
8.4.2	Marking	57
8.4.3	Construction	57
8.4.4	Load Limits	57
8.4.5	Inspections	58
8.4.6	Testing	60
8.4.7	Maintenance	60
8.4.8	Operating Practices	60

DEPARTMENT OF ENERGY HOISTING & RIGGING MANUAL	TITLE: WIRE ROPE, SLINGS, & RIGGING ACCESSORIES	
	NUMBER: 8.0	REV: 00/91

8.5 Rigging Accessories	60
8.5.1 Shackles	60
8.5.2 Eyebolts	63
8.5.3 Turnbuckles	65
8.5.4 Links & Rings	67
8.5.5 Metal-Plate Clamps	69
8.5.6 Special Devices	69
8.5.7 Inspections	71
8.5.8 Testing	71
8.5.9 Good and Bad Rigging Practices	72

FIGURES

8-1 Strength Efficiency of Wire Rope When Bent Over Sheaves and Pins of Various Diameters	3
8-2 Wire-Rope Lays	4
8-3 Wire-Rope Cores	5
8-4 6 x 19 Classification of Wire Rope	6
8-5 6 x 37 Classification of Wire Rope	9
8-6 Balancing Loads	13
8-7 Relationship of Load Angle and Lifting Efficiency	14
8-8 Tension and Head-Room Diagrams for Slings at Various Angles	16
8-9 Wire-Rope Fastenings	25
8-10 Splicing and Fitting Attachment Method For Wire rope	30
8-11 Crosby Clips (The Right Way to Clip Wire Rope)	31
8-12 Crosby Clips (The Wrong Way to Clip Wire Rope)	31
8-13 Double-Based Safety Clips (Drop-Forged Steel, Galvanized)	32
8-14 Types of Chain Slings	35

DRAFT

DEPARTMENT OF ENERGY HOISTING & RIGGING MANUAL	TITLE: WIRE ROPE, SLINGS, & RIGGING ACCESSORIES NUMBER: 8.0 REV: 00/91
---	---

8-15 Choker Hitches with chain slings (Hook Opening Away From Pull of Sling	39
8-16 Typical Metal-Mesh Sling	42
8-17 Endless or Grommet Sling	43
8-18 Standard Eye and Slings	49
8-19 Twisted Eye Slings	49
8-20 Metal End Fittings	49
8-21 Web and Edge Protectors	50
8-22 Effect of Low Sling Angle on Webbing	55
8-23 Shackles	61
8-24 Eyebolts	64
8-25 Turnbuckles	66
8-26 Rings and Links	67
8-27 Metal-Plate Clamp	69
8-28 Good and Bad Rigging Practices	73

TABLES

8-1 Weights of Material	2
8-2 Breaking Strength of Wire Rope (6 x 19 Classification)	8
8-3 Breaking Strength of Wire Rope (6 x 37 Classification)	11
8-4 Load Table of Sling Stresses at Various Angles	15
8-5 Load Capacity of Wire-Rope Slings (Pounds Per Leg)	19
8-6 Load Capacity of Three-Leg Slings	20
8-7 Load Capacity for four-Leg Slings	20
8-8 Load Capacity of Eight-Part Round Body Braided Slings	21
8-9 Safe Working loads for Pressed Sleeve Slings	22
8-10 Rated Capacity of Grommet Slings	23

DEPARTMENT OF ENERGY HOISTING & RIGGING MANUAL	TITLE: WIRE ROPE, SLINGS, & RIGGING ACCESSORIES NUMBER: 8.0 REV: 00/91
---	---

8-11 Safe-Load Capacity of Cable Grommets	24
8-12 Safe-Load Capacity of Rope Grommets	24
8-13 Material Handling Gear (Recommended Minimum Sizes of Gear to be used with Various Sizes of Wire Rope	26
8-14 Number of U Type Clips and Torque for Wire Rope Eye Loop Connections	32
8-15 Safe Loads for Alloy Steel Chain Slings	36
8-16 Maximum Allowable Wear of Chains	38
8-17 Rated Capacities of Carbon Steel and Stainless Steel	43
8-18 Rated Capacity of Dacron Web Slings (5000 lb/in.)	52
8-19 Rated Capacity of Nylon Web Slings (6000 lb/in.)	53
8-20 'Rated Capacity of Nylon Web Slings (8000 lb/in.)	54
8-21 Strength of Standard Sling Hooks	59
8-22 2Strength of Shackles	62
8-23 Safe Loading of Eyebolts	65
8-24 Safe Loads for Weldless Rings and Links	68

EXHIBITS

I Rigging Tackle Annual Inspection (Wire Rope)	76
II Rigging Tackle Annual Inspection (Chain)	77
III Rigging Tackle R=Periodic Inspection (Nonmetallic Slings and Ropes)	79
IV Rigging, Tackle, Accessories Load Test and Inspection (Hooks, Shackles, Rings, etc.)	80
V Lifting Bars and Spreaders Load Test and Inspection	81

DEPARTMENT OF ENERGY HOISTING & RIGGING MANUAL	TITLE: WIRE ROPE, SLINGS, AND RIGGING ACCESSORIES
	NUMBER: 8.0 REV: 00/91

ISSUE NO.

8.0 WIRE ROPE, SLINGS, AND RIGGING ACCESSORIES

8.1 GENERAL:

- 8.1.1** This section provides requirements for the construction of wire rope and for below-the-hook equipment used in Hoisting and Rigging, IE, slings, shackles, eyebolts, rings, wire rope clips, tumbuckles, rigging hooks, yokes, spreader bar and load-indicating devices.
- 8.1.2** The information presented in this section is intended to provide guidance for the safe handling of lifted loads. Diagrams are used to illustrate hoisting and rigging principles, and good and bad rigging practices. This is not a rigging textbook; the information should be applied only by qualified riggers and qualified rigging specialists.
- 8.1.3** Load tables are representative only, and are not exact for all materials or all manufacturers.
- a. Determine the weight of the load:
 - (1) From markings on the load
 - (2) By weighing, if the load is still on the truck or railroad car
 - (3) From drawings, or other documentation
 - (4) By calculation, utilizing the load dimensions and the weights of common materials, Table 8-1.
 - b. Determine the best method of attachment of the load and select the lifting devices, e.g., wire-rope slings, eyebolts, shackles.
 - c. Bending of a wire rope over a fixed object, i.e., a pin or a sheave has an effect on the wire rope. The outside wires and strands of a bend have to stretch farther, and therefore take a greater percentage of the load. The tighter the bend the worse the situation, and the more the ultimate strength of the rope has to be derated.
 - d. There is a convenient method for measuring the sharpness of a bend in a wire rope, and determining the efficiency of the rope as it passes over the bend. This method uses the ratio (R) of the diameter (D) of the object (sheave, pin, corner) about which the wire rope is being bent to the diameter (d) of the rope. The efficiency of the bend can then be determined from Figure 8-1. Note that the efficiency decreases quickly as the ratio of the diameters decreases.
 - e. Aside from efficiency, there are other reasons to avoid sharp bends in wire rope. Physical damage to the rope, reduction of service life, and damage to the object about which the rope is bent can also result.
 - f. When the ratio of the diameter of the bend to the nominal rope diameter (D/d ratio) is small, the strength efficiency factor is lower than when the D/d ratio is relatively large. The tables do not take into account such factors as abnormal temperatures, excessive corrosion, vibration, etc.

DRAFT

DEPARTMENT OF ENERGY HOISTING & RIGGING MANUAL	TITLE: WIRE ROPE, SLINGS, AND RIGGING ACCESSORIES	
	NUMBER: 8.0	REV: 00/91

Table 8-1. Weights of materials

Weights of Common Materials			
Name of Metal	Weight lb/ft ³	Name of Material	Weight lb/ft ³
Aluminum	166	Bluestone	160
Antimony	418	Brick, pressed	150
Bismuth	613	Brick, common	125
Brass, cast	504	Cement, Portland (packed)	100-120
Brass, rolled	523	Cement, Portland (loose)	70-90
Copper, Cast	550	Cement, slag (packed)	80-100
Copper, rolled	555	Cement, slag (loose)	55-75
Gold, 24-carat	1204	Chalk	156
Iron, cast	450	Charcoal	15-34
Iron, wrought	480	Cinder concrete	110
Lead, Commercial	712	Clay, ordinary	120-150
Mercury, 60°F	846	Coal, hard, solid	93.5
Silver	655	Coal, hard, broken	54
Steel	490	Coal, soft, solid	84
Tin, cast	458	Coal, soft, broken	54
Uranium	1163	Coke, loose	23-32
Zinc	437	Concrete, or stone	140-155
		Earth, rammed	90-100
<u>Name of Wood</u>		Granite	165-170
Ash	35	Gravel	117-125
Beech	37	Lime, quick (ground loose)	53
Birch	40	Limestone	170
Cedar	22	Marble	164
Cherry	30	Plaster of paris (cast)	80
Chestnut	26	Sand	90-106
Cork	15	Sandstone	151
Cypress	27	Shale	162
Ebony	71	Slate	160-180
Elm	30	Terra-cotta	110
Fir, Balsam	22	Trap rock	170
Hemlock	31	Water	65

DRAFT

DEPARTMENT OF ENERGY HOISTING & RIGGING MANUAL	TITLE: WIRE ROPE, SLINGS, AND RIGGING ACCESSORIES	REV: 00/91
	NUMBER: 8.0	

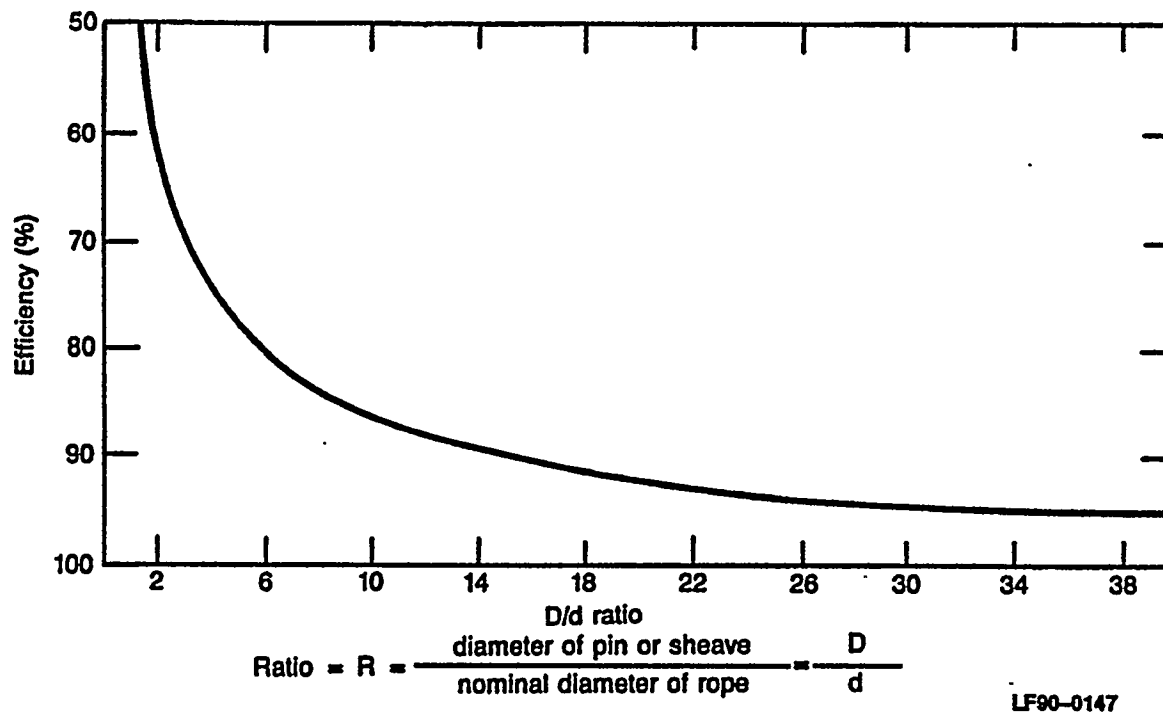

Figure 8-1. Efficiency of wire rope when bent and statically loaded to destruction over sheaves and pins of various diameters.

- g. Determine the appropriate ratings of the device to be used, allowing for:
- (1) The number of sling legs. Note that a sling leg completely doubled back on itself constitutes two sling legs.
 - (2) The angle between the horizontal surface of the load and the sling leg. The smaller the angle, the smaller the lifting capacity of the equipment. (Table 8-2)
 - (3) Wear. The reduction in strength of the equipment due to normal wear.

8.2 WIRE ROPE:

8.2.1 Wire-Rope Lays

- a. When talking about wire rope, the word "lay" has a particular meaning which can be confusing to the uninitiated.

**DEPARTMENT OF
ENERGY
HOISTING & RIGGING
MANUAL**

**TITLE: WIRE ROPE, SLINGS, AND RIGGING
ACCESSORIES**

NUMBER: 8.0

REV: 00/91



Right Regular Lay: Right lay because the strands twist to the right like a conventional screw thread. Identified as regular lay because the wires in the strands turn opposite to the way the strands turn in the rope.



Left Regular Lay: In a left-lay rope, the strands rotate to the left around the core. Identified as regular lay same as above; i.e., the wires turn right in the individual strands, while the strands turn to the left.



Right Lang Lay: When both the strands and wires have the same lay direction, the rope is said to be lang lay. In a right lang-lay rope, the wires and the strands would rotate to the right.



Left Lang Lay: A rope where both the wires and the strands rotate to the left in the same direction.

LF90-0191

NOTE: The standard rope, unless otherwise stated, is understood to be right regular lay. With few exceptions, all wire rope is made right lay. Left-lay rope is a special-purpose rope for specific applications only.

Figure 8-2. Wire rope lays.

DRAFT

DEPARTMENT OF ENERGY HOISTING & RIGGING MANUAL	TITLE: WIRE ROPE, SLINGS, AND RIGGING ACCESSORIES NUMBER: 8.0 REV: 00/91
---	---

- b. The term "lay length" is the longitudinal distance measured along a wire rope in which a strand makes one complete revolution about the rope axis.
- c. The word is also used to denote the direction of rotation of the wires and strands as illustrated below.

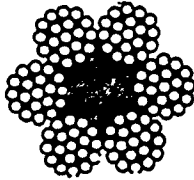

Fiber or Sisal Core: Sisalanna is the most common fiber used in the manufacture of wire-rope cores. In the smaller ropes and cords, cotton and jute are sometimes employed for the central member.

Wire rope cores are carefully designed and must be precisely manufactured to close tolerances to ensure a perfect fit in the rope.

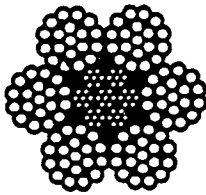

Independent Wire Rope Core (I.W.R.C.): The primary function of the core is to provide adequate support for the strands. When severe crushing or flattening of the rope is encountered, an I.W.R.C. is usually specified.

As the name I.W.R.C. implies, this core is actually a separate small rope inside a larger rope.

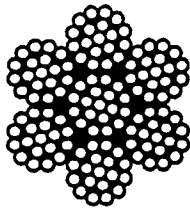

Strand Core: A single strand used as a core and generally confined to the smaller ropes as a substitute for the I.W.R.C. The strand core may or may not be of the same cross section as the surrounding strands.

LF90-0190

Figure 8-3. Wire-rope cores.

DEPARTMENT OF ENERGY HOISTING & RIGGING MANUAL	TITLE: WIRE ROPE, SLINGS, AND RIGGING ACCESSORIES NUMBER: 8.0 REV: 00/91
---	---

8.2.2 Wire-Rope for General Purpose

- a. **6 x 19 Classification:** This classification is the most versatile of all ropes made. Most applications can use a rope from this classification.

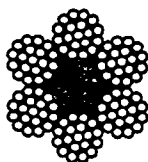

FC



6 x 19F

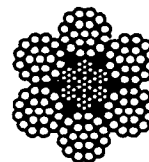

IWRC

The most popular and versatile of all wire ropes and the most flexible is the 6 x 19 classification. This rope is considered the perfect compromise between maximum abrasion resistance and maximum flexibility.

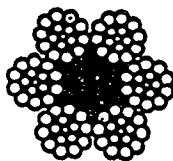

FC



6 x 16F

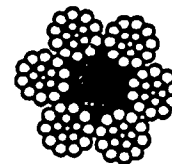

IWRC

LF90-0192

Slightly more abrasion resistant than the 6 x 19F, the 6 x 16F makes an excellent rope for small draglines and similar uses. The resistance to wear is gained by a slight sacrifice in flexibility.

Figure 8-4. 6 x 19 Classification of wire rope.

DRAFT

**DEPARTMENT OF
ENERGY
HOISTING & RIGGING
MANUAL**

**TITLE: WIRE ROPE, SLINGS, AND RIGGING
ACCESSORIES**

NUMBER: 8.0

REV: 00/91

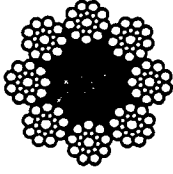

FC



6 x 19 Seale

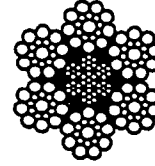

IWRC

A rugged wire rope for applications involving heavy wear. Car pullers often use this rope, and it is widely used for slushers and drag scrapers.

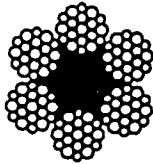

FC



6 x 19 Warrington

LF90-0193

The alternate large and small outer wires make this rope an all-around performer. Used for general purpose hoisting, chum drills, and often for miscellaneous slings.

Figure 8-4. (continued).

DRAFT

DEPARTMENT OF ENERGY HOISTING & RIGGING MANUAL	TITLE: WIRE ROPE, SLINGS, AND RIGGING ACCESSORIES	REV: 00/91
	NUMBER: 8.0	

Table 8-2. Breaking strength of wire rope (6 x 19 classifications)

6 x 19 (1 FC)				6 x 19 (IWRC)			
Rope diameter (in.)	Weight lb per ft	Breaking strength in tons of 2000 lb		Rope diameter (in.)	Weight lb per ft	Breaking strength in tons of 2000 lb	
		Plow steel	Improved plow steel			Plow Steel	Improved plow steel
3/16	0.06	1.3	1.5	3/16	0.07	1.4	1.6
1/4	0.10	2.4	2.7	1/4	0.11	2.6	2.9
5/16	0.16	3.8	4.1	5/16	0.18	4.1	4.4
3/8	0.23	5.4	6.0	3/8	0.25	5.8	6.5
7/16	0.31	7.0	8.0	7/16	0.34	7.5	8.6
1/2	0.40	10.0	11.0	1/2	0.44	10.8	11.8
9/16	0.51	11.7	13.3	9/16	0.56	12.6	14.3
5/8	0.63	15.0	16.5	5/8	0.69	16.1	17.7
3/4	0.90	21.5	23.8	3/4	0.99	23.1	25.6
7/8	1.23	28.3	32.0	7/8	1.35	30.4	34.4
1	1.60	38.0	41.7	1	1.76	40.8	44.8
1 1/8	2.03	48.5	53.0	1 1/8	2.23	52.1	57.0
1 1/4	2.50	60.0	65.0	1 1/4	2.75	64.5	70.4
1 3/8	3.03	73.5	81.0	1 3/8	3.33	79.0	87.1
1 1/2	3.60	88.5	96.0	1 1/2	3.96	95.1	103.0
1 5/8	4.23	103.0	113.0	1 5/8	4.65	111.0	122.0
1 3/4	4.90	119.0	130.0	1 3/4	5.39	128.0	140.0
1 7/8	5.63	138.0	152.0	1 7/8	6.19	148.0	163.0
2	6.40	154.0	169.0	2	7.04	166.0	182.0
2 1/4	8.10	193.0	210.0	2 1/4	8.91	208.0	226.0
2 1/2	10.00	235.0	260.0	2 1/2	11.00	253.0	280.0
2 3/4	12.10	280.0	305.0	2 3/4	13.30	301.0	328.0

DRAFT

DEPARTMENT OF ENERGY HOISTING & RIGGING MANUAL	TITLE: WIRE ROPE, SLINGS, AND RIGGING ACCESSORIES	
	NUMBER: 8.0	REV: 00/91

- b. **6 x 37 Classification:** When sheaves and drums are fairly small and abrasive conditions not severe, the ropes in this classification will show better performance than the coarser 6 x 19 construction. Under conditions of repeated bending, they will outlast a 6 x 19 rope; when abrasion is severe, the small outer wires quickly show the effect.

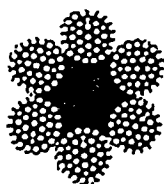

FC



6 x 37 2-Operation

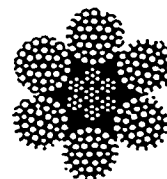

IWRC

A 2-operation strand with 18 outer wires. This construction is used on industrial equipment, for flexible slings, and miscellaneous hoisting.

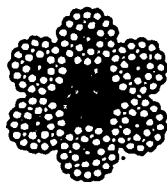

FC



6 x 29F

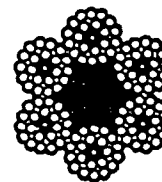

IWRC

Used for applications requiring a flexible rope slightly more resistant to wear than the 6 x 37, 2-operation shown above.

LF90-0194

Figure 8-5. 6 x 37 Classification of wire rope.

DRAFT

DEPARTMENT OF ENERGY HOISTING & RIGGING MANUAL	TITLE: WIRE ROPE, SLINGS, AND RIGGING ACCESSORIES NUMBER: 8.0 REV: 00/91
---	---

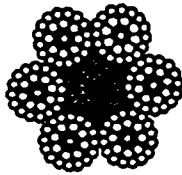

FC



6 x 41

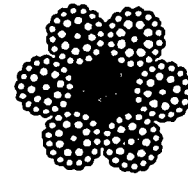

IWRC

LF90-0195

A single operation strand, used widely for ropes over 1-inch diameter in the 6 x 37 classification.

Figure 8-5. (continued).

**Table 8-3. Breaking strength of wire rope (6 x 37 classifications)
6 x 37 (1 FC)**

Rope diameter in.	Weight lb per ft	Breaking strength in tons of 2000 lb	
		Plow Steel	Improved plow steel
1/4	0.10	2.2	2.5
5/16	0.16	3.8	4.0
3/8	0.22	5.0	5.5
7/16	0.30	6.9	7.5
1/2	0.39	9.2	10.0
9/16	0.49	11.4	12.5
5/8	0.61	14.5	16.0
3/4	0.87	20.2	22.2
7/8	1.19	27.5	30.2
1	1.55	36.0	39.5
1 1/8	1.96	44.0	49.0
1 1/4	2.42	55.0	61.0
1 3/8	2.93	68.5	74.5
1 1/2	3.49	82.0	90.0
1 5/8	4.09	96.5	105.5
1 3/4	4.75	110.0	121.0
1 7/8	5.45	129.0	142.0
2	6.20	142.0	155.0
2 1/4	7.85	182.0	201.0
2 1/2	9.69	225.0	245.0
2 3/4	11.72	269.0	293.0
3	13.95	323.0	353.0

6 x 37 (IWRC)

Rope diameter in.	Weight lb per ft	Breaking strength in tons of 2000 lb	
		Plow Steel	Improved plow steel
1/4	0.11	2.4	2.7
5/16	0.18	4.1	4.3
3/8	0.24	5.4	5.9
7/16	0.33	7.4	8.1
1/2	0.43	9.9	10.8
9/16	0.54	12.3	13.4
5/8	0.67	15.6	17.2
3/4	0.96	21.7	23.9
7/8	1.30	29.6	32.5
1	1.71	38.7	42.5
1 1/8	2.16	47.3	52.7
1 1/4	2.66	59.1	65.6
1 3/8	3.22	73.6	80.1
1 1/2	3.84	88.1	96.7
1 5/8	4.50	104.0	113.0
1 3/4	5.23	118.0	130.0
1 7/8	6.00	139.0	153.0
2	6.82	153.0	167.0
2 1/4	8.64	196.0	216.0
2 1/2	10.66	242.0	263.0
2 3/4	12.89	289.0	315.0
3	15.35	347.0	379.0

8.2.3 Wire-Rope Maintenance

- a. Rope shall be stored in such a manner as to prevent damage or deterioration.
- b. Unreeling or uncoiling of rope shall be done as recommended by the rope manufacturer or a qualified person, and with care to avoid kinking or inducing a twist.
- c. Before cutting a rope, means shall be used to prevent unlaying of the strands. Flame cutting of wire rope is prohibited.
- d. During installation, care should be observed to avoid dragging the rope in dirt or around objects which will scrape, nick, crush, or induce sharp bends.
- e. Unless prohibited by other considerations, rope should be maintained in a well-lubricated condition. Lubricant applied as a part of a maintenance program shall be compatible with the original lubricant, and the rope manufacturer should be consulted. Lubricant applied shall be of the type which does not hinder visual inspection. Those sections of rope, which are located over sheaves or otherwise hidden during inspection and maintenance procedures, require special attention when lubricating rope. The object of rope lubrication is to reduce internal friction and to prevent corrosion.

8.3 SLINGS:

8.3.1 General

- a. Slings shall have a minimum safety factor of 5, based on breaking strength. Features which affect the rated capacity of the sling and shall be considered in calculating the factor of safety are:
 - (1) Nominal breaking strength of material from which it is constructed
 - (2) Splicing or end-attachment efficiency
 - (3) Number of parts in the sling
 - (4) Type of hitch, e.g., straight pull, choker hitch, or basket hitch
 - (5) Angle of loading
 - (6) Diameter of curvature around which the sling is bent.
- b. (Published working loads for chain slings are usually based on 25-33% of the breaking strength.)
- c. The center of gravity of an object is a point around which the entire weight may be concentrated. In order to make a level lift, the crane hook or point of suspension must be directly above this point. While slight variations are usually permissible, if the crane hook is too far to one side of the center of gravity, dangerous tilting will result and should be corrected at once. For this reason, when the center of gravity is closer to one point of the sling attachment than to the other, the slings must be of unequal length. Sling stresses and sling angles will also be unequal. (Figure 8-6)

- d. Slings shall be secured or terminated in the crane hook so that the sling does not reeve or slip through the hook. To attach the load, locate the center of gravity (CG), position the crane hook directly above the (CG), and then rig the load so that it will lift level and true.
- e. The following is an example of selecting a sling using the load angle factor, as shown in Figure 8-7 and Table 8-4.

- Load = 1000 lb
- Sling = 2-legged bridle
- Angle with horizontal = 45-degrees
- Load angle factor from Figure 6-2 = 1.414

Each of the two legs would lift 500 lb if a vertical lift were made. However, there is a 45-degree sling angle involved. Therefore, the 500-lb load would be multiplied by the load-angle factor in the chart (1.414), giving a total of 707 lb ($500 \text{ lb} \times 1.414 = 707 \text{ lb}$) tension in each sling leg. Each sling leg, therefore, must have a rated capacity of at least 707 lb.

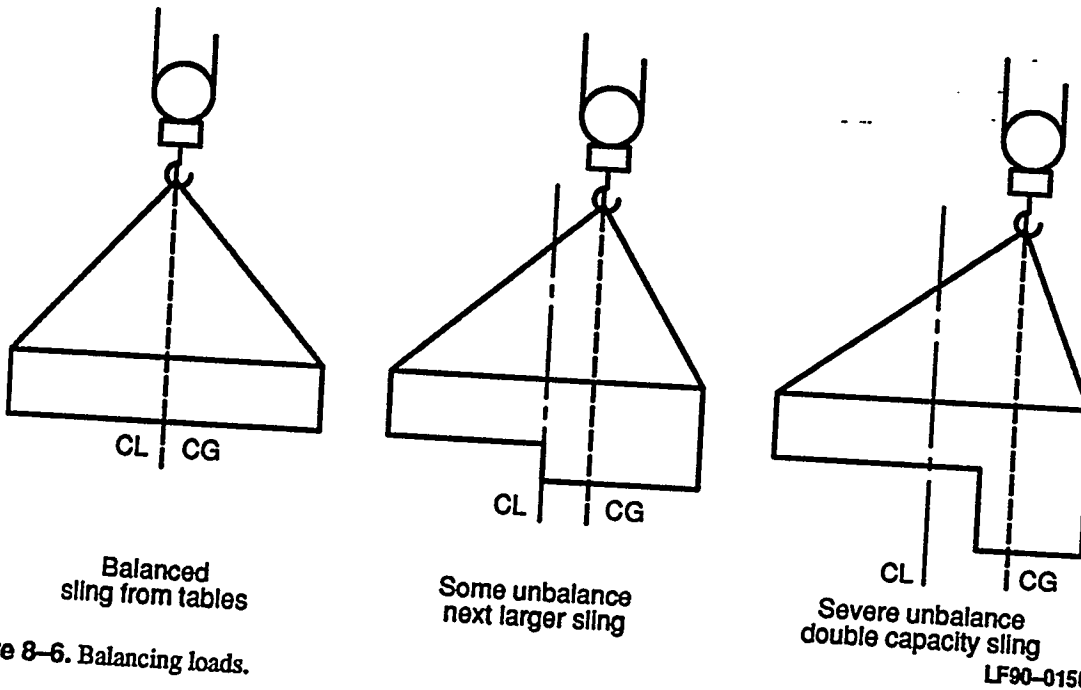
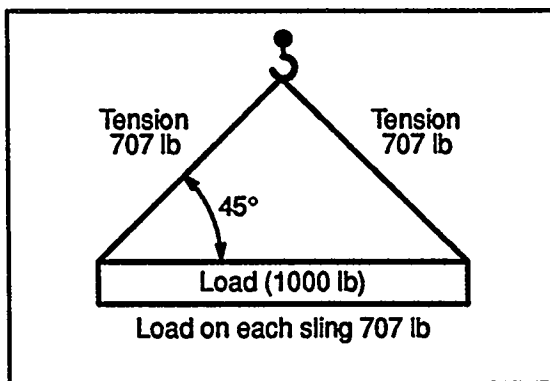
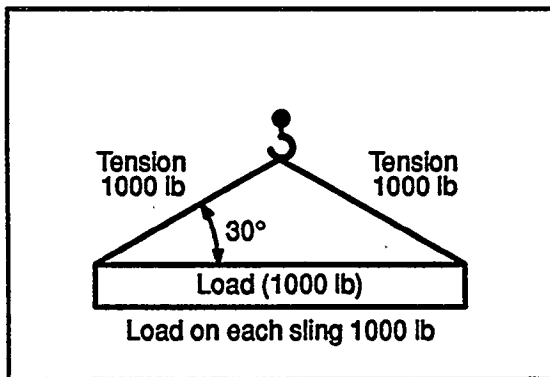
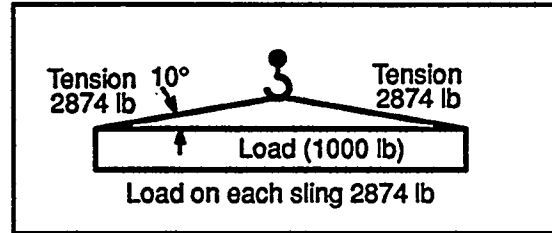
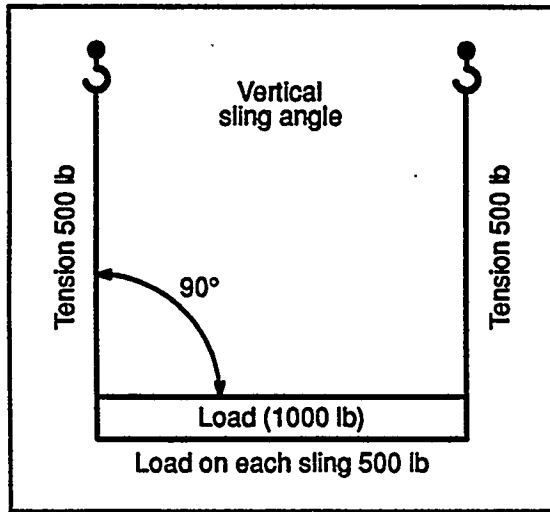

Figure 8-6. Balancing loads.



Sling angle	Load angle factor
90°	1,000
85°	1,004
80°	1,015
75°	1,035
70°	1,064
65°	1,104
60°	1,155
55°	1,221
50°	1,305
45°	1,414
40°	1,555
35°	1,742
30°	2,000
25°	2,364
20°	2,924
15°	3,861
10°	5,747
5°	11,490

LF90-0149

Figure 8-7. Relationship of load angle and lifting efficiency.

DEPARTMENT OF ENERGY HOISTING & RIGGING MANUAL	TITLE: WIRE ROPE, SLINGS, AND RIGGING ACCESSORIES	REV: 00/91
	NUMBER: 8.0	

Table 8-4. Load table of sling/stresses at various angles

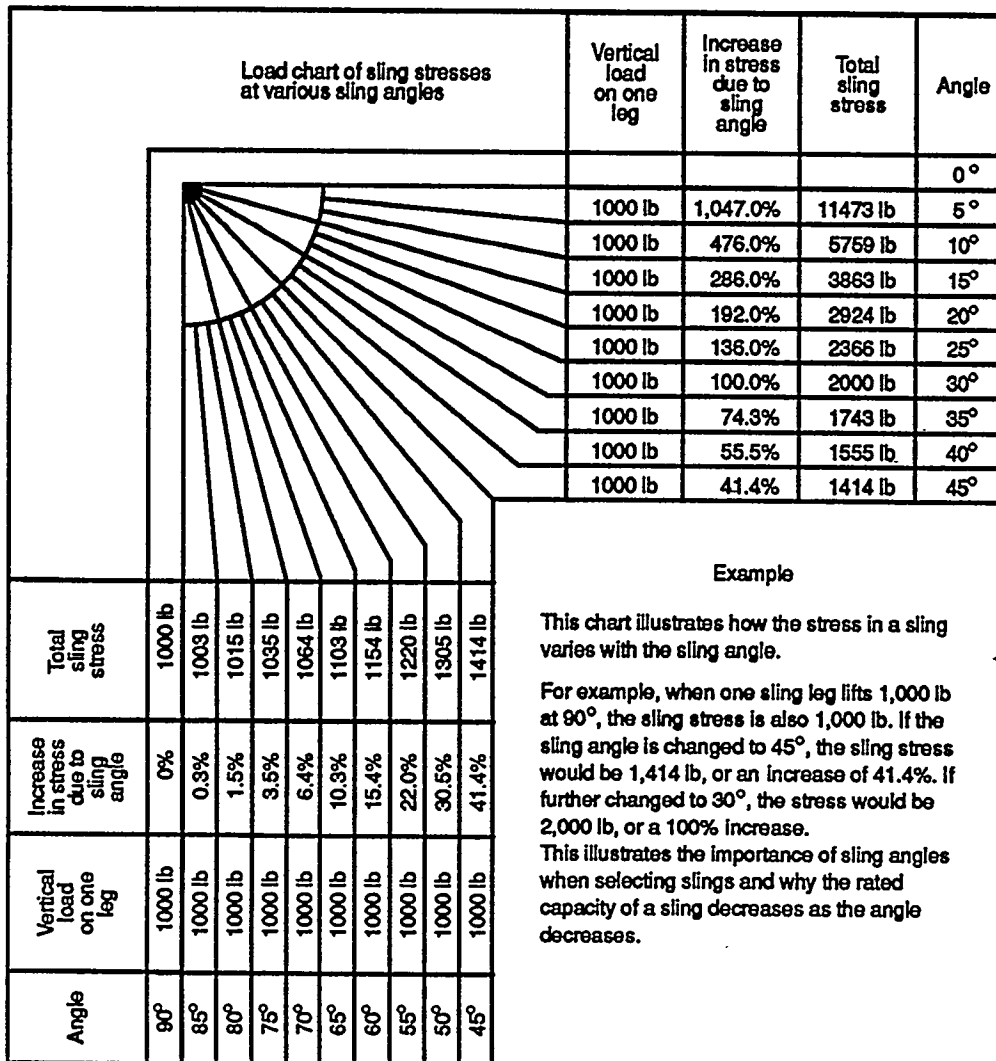

LF90 0019

DRAFT

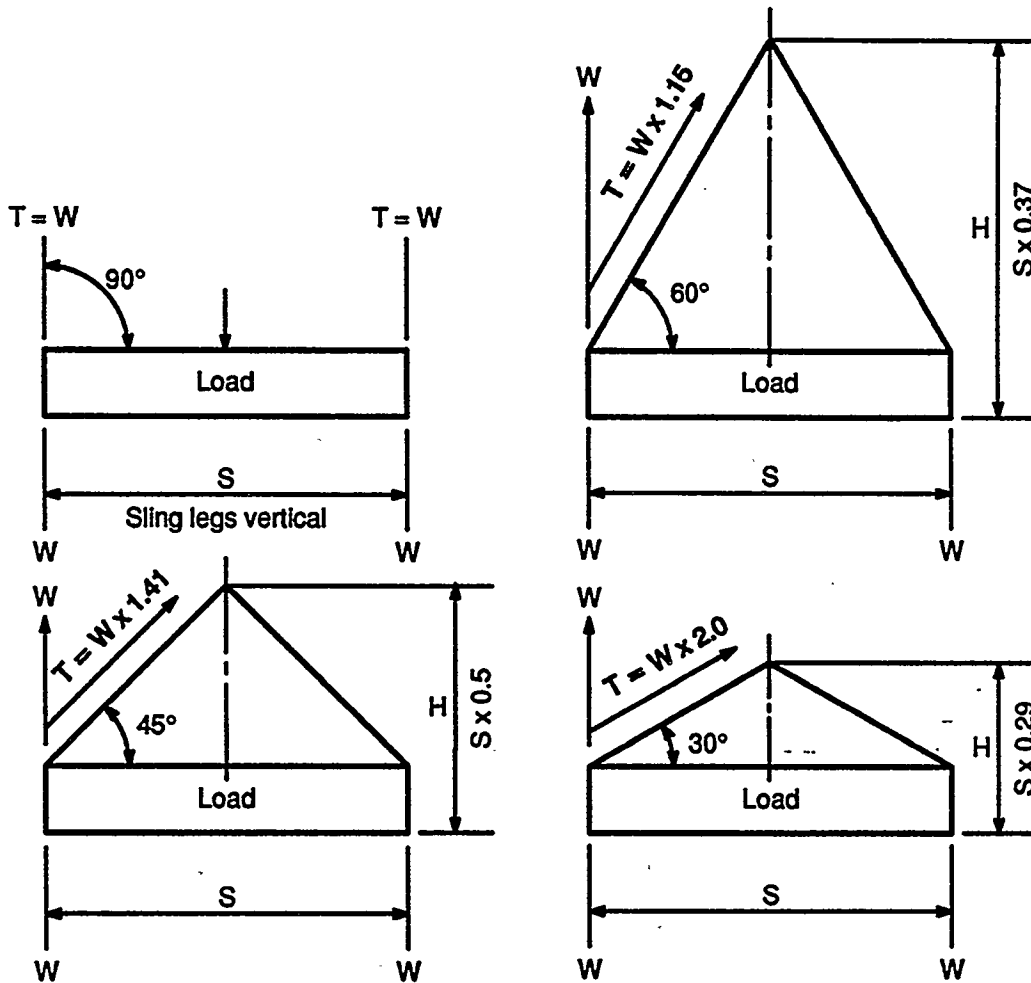

W = Weight lifted by sling leg		T = Tension in sling leg = W x E									H = Head-room = S x K	
Angle	80°	70°	65°	60°	55°	50°	45°	40°	35°	30°	E	K
E	1.02	1.06	1.10	1.15	1.22	1.31	1.41	1.56	1.74	2.00		
K	2.83	1.37	1.07	0.87	0.71	0.60	0.50	0.42	0.35	0.29		

Figure 8-8. Tension and head-room diagrams for slings at various angles.

8.3.2 Safe Load

The safe working load or rated capacity of a sling varies depending upon the type of hitch. The safe-load tables shown in this Manual section indicate, by illustration, the applications for which the various safe loads apply when the slings are new. All ratings are in tons of 2000 lb.

8.3.3 Factor of Safety

In general, a factor of safety of 5 is maintained throughout this section. However, certain sling fittings, such as hooks (which will straighten without breaking) or links (which will deform beyond usefulness before breaking), cannot be assigned a definite numerical safety factor. In such cases, suitable safe loads are listed, based upon wide experience and sound engineering practice.

NOTE: Published factors of safety for chain slings are usually from 3 to 4, based on breaking strength. Section 4.1.1 requires a minimum factor of 5 for slings.

8.3.4 Sling Care

Proper care and usage are essential for maximum service and safety. Wire-rope slings should be protected from sharp bends and cutting edges by means of corner saddles, burlap padding, or wood blocking. Heavy or continuous overloading should be avoided, as well as sudden jerks which can build up a momentary overload sufficient to break the sling. Slings should be lubricated to prevent rust, and hung up when not in use.

8.3.5 Sling Storage

a. Wire-Rope and Chain Slings

- (1) Slings shall be stored in racks or in designated locations when not in use.
- (2) Slings should be wiped clean periodically to remove as much dirt and abrasive grit as possible, and be relubricated to extend their useful life. Chains should not be lubricated when in use.
- (3) Slings should never be stored in damp or dirty places, or in places exposed to corrosive materials or weather. For long-term storage, they should be cleaned and lubricated.
- (4) Slings may require segregated storage, as determined on a case by case basis.
- (5) Slings for hoisting and handling of Special-High-Consequence Loads shall not be used for any other purpose, shall be identified for special service, and shall be kept in segregated storage. A history of each use of such items on High-Consequence Lifts shall be maintained.

b. Metal-and Synthetic-Mesh Slings

- (1) Slings shall be stored in racks (preferably vertical), and in designated locations.
- (2) Slings shall be wiped down periodically to remove as much dirt and abrasive grit as possible.
- (3) Metal-mesh slings shall not be stored in areas where the temperature exceeds 550°F (288°C); 200°F (93°C) if elastomer covered.

**TITLE: WIRE ROPE, SLINGS, AND RIGGING
ACCESSORIES**

NUMBER: 8.0

REV: 00/91



- (4) Synthetic-mesh slings shall not be stored where the temperature exceeds 200°F (93°C).
- (5) Slings may require segregated storage, as determined on a case by case basis.
- (6) Slings for hoisting and handling Special-High-Consequence Lifts shall not be used for any other purpose, shall be identified for special service, and shall be kept in segregated storage. A history of each use of such items in Special-High-Consequence Lifts shall be maintained.

8.3.6 Wire-Rope Slings

- a. In general, wire-rope slings are made up of the same types of wire rope used for running rigging. Different kinds of slings have been developed for specific jobs. These are divided into different groups or types as follows:
 - (1) Endless-loop slings (grommet construction) and single-part slings with single-rope legs, double-rope legs, or multiple-part-rope legs
 - (2) Two-leg bridle slings with single-rope legs, equalizing double-rope legs, or multiple-part-rope legs
 - (3) Three-leg bridle slings
 - (4) Four-leg bridle slings
 - (5) Special slings and combinations
- b. The total load which can be safely lifted with slings depends upon the rating of the slings and the manner in which the slings are attached to the load. Consult load tables 8-5 through 8-13 and Figure 8-9.
 - (a) Fiber core wire rope slings of all grades shall not be exposed to temperatures in excess of 200°F.
 - (b) When wire rope slings of any grade are to be used at temperatures above 400°F, or below minus 60°F, the sling manufacturer should be consulted.
 - (c) Extremely low temperatures (<0°F) may cause brittle fractures. Under these conditions, sudden loading should be avoided and the rope should be carefully observed while the load is being applied.

DRAFT

Table 8-5. Load capacity of wire-rope slings (lb per leg)

Sling diameter inches	Straight				Choker			
	Single Leg	Multiple Leg			Single Leg	Multiple Leg		
		 LF90-0196				 LF90-0197		
		60°	45°	30°		60°	45°	30°
3/4	900	800	640	450	700	590	480	340
7/16	1 400	1 200	1 000	700	1 100	900	750	530
1 1/8	2 000	1 700	1 400	1 000	1 500	1 300	1 100	750
1 1/4	2 800	2 400	2 000	1 400	2 100	1 800	1 500	1 100
1 3/8	3 400	3 000	2 400	1 700	2 600	2 200	1 800	1 300
1 1/2	4 400	3 800	3 100	2 200	3 300	2 900	2 300	1 700
1 5/8	5 200	4 500	3 700	2 600	3 900	3 400	2 800	2 000
2	7 400	6 400	5 300	3 700	5 600	4 800	3 900	2 800
2 1/4	9 800	8 500	7 000	4 900	7 400	6 400	5 200	3 700
2 3/4	12 800	11 000	9 100	6 400	9 600	8 300	6 800	4 900
3	16 000	14 000	11 500	8 000	12 000	10 400	8 500	6 100
3 1/2	19 600	17 000	14 000	9 800	14 700	12 800	10 400	7 500
4	24 000	21 000	17 000	12 000	18 000	15 600	12 700	9 100
4 1/2	28 000	24 500	20 000	14 000	21 000	18 000	15 000	10 600
5	1.00	0.87	0.71	0.50	0.75	0.65	0.53	0.38

Multipliers in the above table show the relationship between the loads in each column and straight single-leg slings. For slings with three legs, the total loads which may be safely lifted are three times the values shown. For slings with four individual legs, the total loads shall not exceed the values for three-leg slings. For double-basket-type slings (2-looped slings making 4 legs), the total loads may be four times the values shown. The following tabulation gives the loads in pounds for wire-rope slings of improved plow steel. The ratio of safety for other materials is given by:

Material	Multiplier
Mid plow steel	0.76
Plow steel	0.87
Extra-improved plow steel	1.10

0.80 has been included in the above to allow for splicing.

Table 8-6. Load capacity for three-leg slings

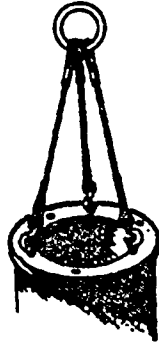

LF90-0198

Rated Capacity in Tons for Three-leg Slings														
Slings rope diameter in.		1/4	3/8	1/2	5/8	3/4	7/8	1	1 1/8	1 1/4	1 3/8	1 1/2	1 5/8	1 3/4
Leg angles	Vertical Load	1.4	3.0	5.4	8.4	12.0	15.9	21.0	24.6	30.6	37.2	45.0	52.5	60.6
	60°	1.2	2.6	4.7	7.3	10.4	13.8	18.2	21.2	26.2	32.2	39.0	45.5	52.4
	45°	.99	2.1	3.8	5.9	8.5	11.2	14.8	17.3	21.4	26.2	31.7	37.0	42.8
	30°	.70	1.5	2.7	4.2	6.0	8.0	10.5	12.3	15.3	18.6	22.5	26.3	30.0
Ring size	Inside dia. (in.)	6	6	7	7	7	8	9	9	10	10	12	12	12
	Stock dia. (in.)	7/8	1 1/8	1 3/8	1 5/8	1 7/8	2 1/8	2 1/2	2 3/4	3	3 1/4	3 1/2	3 3/4	4

Table 8-7. Load capacity for four-leg slings

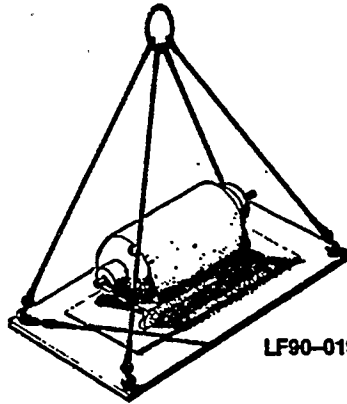

LF90-0199

Rated Capacity in Tons for Four-leg Slings														
Slings rope diameter in.		1/4	3/8	1/2	5/8	3/4	7/8	1	1 1/8	1 1/4	1 3/8	1 1/2	1 5/8	1 3/4
Leg angles	60°	1.6	3.4	6.2	9.8	13.8	18.4	24.2	28.4	35.2	42.8	52.0	60.6	69.6
	45°	1.3	2.8	5.0	8.0	11.4	15.0	19.6	23.2	28.8	35.0	42.4	49.6	57.0
	30°	0.9	2.0	3.6	5.6	8.0	10.6	14.0	16.4	20.4	24.8	30.0	35.0	40.4
Ring size	Inside dia. (in.)	6	6	7	7	8	8	9	10	10	12	12	12	12
	Stock dia. (in.)	7/8	1 1/8	1 5/8	1 7/8	2 1/8	2 1/2	2 3/4	3	3 1/4	3 1/2	3 3/4	4	4 1/4

TITLE: WIRE ROPE, SLINGS, AND RIGGING ACCESSORIES	NUMBER: 8.0	REV: 00/91
	REV: 00/91	

Capacity of eight-part round body braided slings (lb per leg)

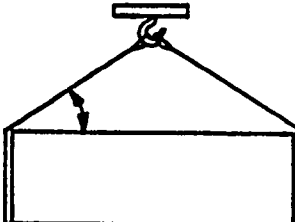
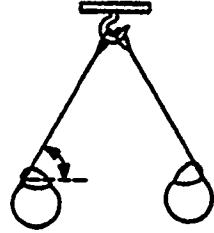
Sling Weight	Straight			Choker			
	Multiple leg			Multiple leg			
	 LF90-0199			 LF90-0201			
	60°	45°	30°	Single Leg	60°	45°	30°
500	1,300	1,100	750	1,200	980	800	560
400	3,000	2,500	1,700	2,600	2,200	1,800	1,250
300	5,200	4,200	3,000	4,800	3,900	3,200	2,250
200	8,500	7,000	5,000	7,000	6,500	5,300	3,700
100	12,000	10,000	7,000	10,000	9,100	7,400	5,200
50	15,500	13,000	9,000	14,000	11,700	9,500	6,700
25	21,000	17,000	12,000	18,000	15,500	13,000	9,000
12.5	28,000	21,000	15,000	22,000	19,500	16,000	11,000
6.25	33,000	27,000	19,000	28,500	25,000	20,000	14,000
3.125	47,000	38,000	27,000	40,000	35,000	29,000	20,000
1.5625	62,000	51,000	36,000	54,000	47,000	38,000	27,000
0.78125	81,000	66,000	47,000	70,000	61,000	50,000	35,000
0.390625	128,000	105,000	74,000	110,000	98,000	78,000	55,000
	0.87	0.71	0.50	0.75	0.65	0.53	0.375

Reduction factors show the relationship between the loads in each column and the straight single-leg

**DEPARTMENT OF
ENERGY
HOISTING & RIGGING
MANUAL**

**TITLE: WIRE ROPE, SLINGS, AND RIGGING
ACCESSORIES**

NUMBER: 8.0

REV: 00/91

Table 8-9. Safe working loads for pressed-sleeve slings

Rope size (in.)	Vertical lift LF90-0212 (lb)	Choker hitch LF90-0213 (lb)	Basket hitch LF90-0214 (lb)	Two part bridle sling LF90-0215		
				30° S.W.L. 2 Legs (lb)	45° S.W.L. 2 Legs (lb)	60° S.W.L. 2 Legs (lb)
1/4	920	700	1,840	1,600	1,300	920
3/8	2,020	1,520	4,040	3,500	2,860	2,020
1/2	3,740	2,800	7,480	6,480	5,280	3,740
5/8	5,600	4,200	11,200	9,700	7,920	5,600
3/4	8,080	6,060	16,160	14,020	11,460	8,080
7/8	10,920	8,180	21,840	18,920	15,480	10,920
1	14,180	10,680	28,360	24,600	20,060	14,180
1 1/8	16,660	12,500	33,320	28,900	23,500	16,660
1 1/4	20,740	15,540	41,480	36,000	29,300	20,740
1 3/8	25,340	19,000	50,680	43,880	35,840	25,340
1 1/2	30,620	22,960	61,240	53,040	43,300	30,620
1 5/8	35,900	26,920	71,800	62,180	50,760	35,900
1 3/4	41,160	30,860	82,320	71,280	58,200	41,160
1 7/8	48,320	36,240	96,640	83,680	68,320	48,320
2	52,760	39,560	105,520	91,360	74,600	52,760

All calculated on the basis of 6-to-1 safety factor, and based on the use of 6 x 19 regular lay preformed improved plow steel, with independent wire-rope center for sizes from 1/4 in. to 1 in. diameter inclusive; and 6 x 37 classification regular lay preformed improved plow steel with independent wire-rope center for diameters beyond 1 in.

Note: Spliced chokers would have a slightly reduced safe working load.

DRAFT

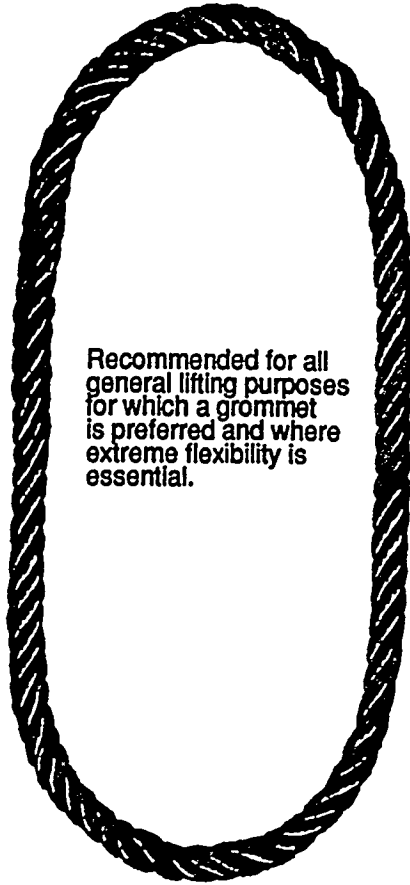
Table 8-10. Rated capacity of grommet slings

Recommended for all general lifting purposes for which a grommet is preferred and where extreme flexibility is essential.

RATED CAPACITY OF GROMMET SLINGS

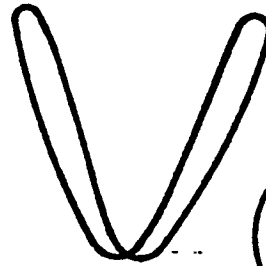
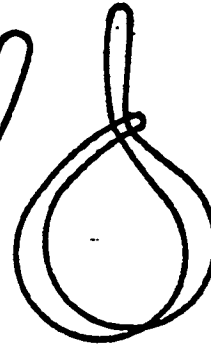
Vertical

Cradle

Choker
LF90-0203

Rated Capacity Of Grommet Slings							
Dia. of Grommet (in.)	Rated capacity—tons			Dia. of Grommet (in.)	Rated capacity—tons		
	Vertical	Cradle	Choker		Vertical	Cradle	Choker
1/4	0.7	1.4	0.5	1 1/8	13.2	26.4	9.9
3/8	1.6	3.2	1.2	1 1/4	16.4	32.8	12.3
1/2	3.0	6.0	2.3	1 3/8	20.0	40.0	15.0
5/8	4.4	8.8	3.3	1 1/2	24.1	48.2	18.1
3/4	6.4	12.8	4.8	1 5/8	28.3	56.6	21.2
7/8	8.6	17.2	6.5	1 3/4	32.5	65.0	24.4
1	11.2	22.4	8.4	2	41.7	83.4	31.2

DEPARTMENT OF ENERGY HOISTING & RIGGING MANUAL	TITLE: WIRE ROPE, SLINGS, AND RIGGING ACCESSORIES
	NUMBER: 8.0 REV: 00/91

Table 8-11. Safe-load capacity of cable grommets

Size (in.)	Safe Load (lb)					
	Straight pull	Choker hitch	Basket Hitch			
			Vertical	60 ^{oa}	45 ^{oa}	30 ^{oa}
3/8	2,600	1,900	5,000	4,400	3,600	2,600
9/16	5,600	4,200	11,200	9,800	8,000	5,600
5/8	7,800	6,000	15,800	13,600	11,200	6,800
3/4	10,200	7,600	20,000	17,600	14,400	10,200
15/16	15,800	11,800	32,000	28,000	22,000	15,800
1 1/8	22,000	16,800	44,000	38,000	32,000	22,000
1 5/16	30,000	22,000	60,000	52,000	42,000	30,000
1 1/2	38,000	28,000	78,000	66,000	54,000	38,000
1 11/16	48,000	36,000	98,000	84,000	68,000	48,000
1 7/8	60,000	44,000	120,000	104,000	84,000	60,000
2 1/4	84,000	62,000	168,000	146,000	118,000	84,000
2 5/8	112,000	84,000	224,000	194,000	158,000	112,000
3	144,000	108,000	288,000	248,000	202,000	144,000

Note: Cable grommets are made from wire rope.

a. Angle of legs to horizontal

Table 8-12. Safe-load capacity of rope grommets

Size (in.)	Safe Load (lb)					
	Straight pull	Choker hitch	Basket Hitch			
			Vertical	60 ^{oa}	45 ^{oa}	30 ^{oa}
1/4	1,840	1,380	3,600	3,200	2,600	1,840
3/8	4,000	3,000	8,000	7,000	5,800	4,000
1/2	7,000	5,200	14,000	12,200	10,000	7,000
5/8	10,800	8,000	22,000	18,800	15,200	10,800
3/4	15,200	11,400	30,000	26,000	22,000	15,200
7/8	20,000	15,200	40,000	34,000	28,000	20,000
1	26,000	19,400	52,000	44,000	36,000	26,000
1 1/8	30,000	22,000	62,000	52,000	44,000	30,000
1 1/4	36,000	28,000	72,000	64,000	52,000	36,000
1 3/8	44,000	32,000	88,000	76,000	62,000	44,000
1 1/2	52,000	38,000	104,000	90,000	72,000	52,000
1 3/4	68,000	52,000	136,000	120,000	98,000	68,000
2	88,000	66,000	176,000	152,000	124,000	88,000
1 1/4	108,000	82,000	216,000	188,000	154,000	108,000

Note: Rope grommets are made from strand.

a. Angle of legs to horizontal

DRAFT

<p>DEPARTMENT OF ENERGY HOISTING & RIGGING MANUAL</p>	<p>TITLE: WIRE ROPE, SLINGS, AND RIGGING ACCESSORIES</p> <p>NUMBER: 8.0</p> <p>REV: 00/91</p>
--	--

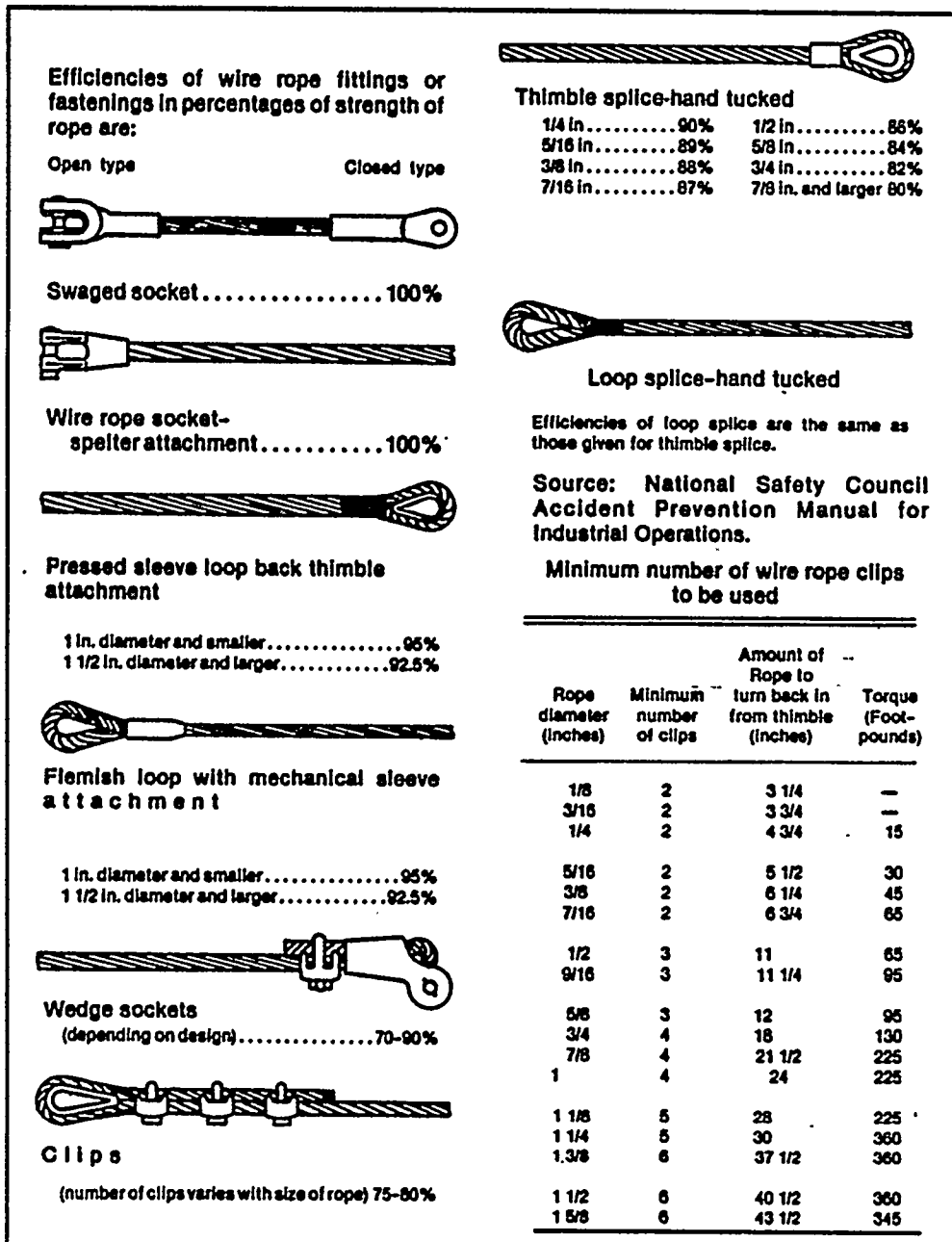

LF90-0204

Figure 8-9. Wire rope fastenings.

DEPARTMENT OF ENERGY HOISTING & RIGGING MANUAL	TITLE: WIRE ROPE, SLINGS, AND RIGGING ACCESSORIES
	NUMBER: 8.0 REV: 00/91

Table 8-13. Material handling gear (recommended minimum sizes of gear to be used with various sizes of wire rope).

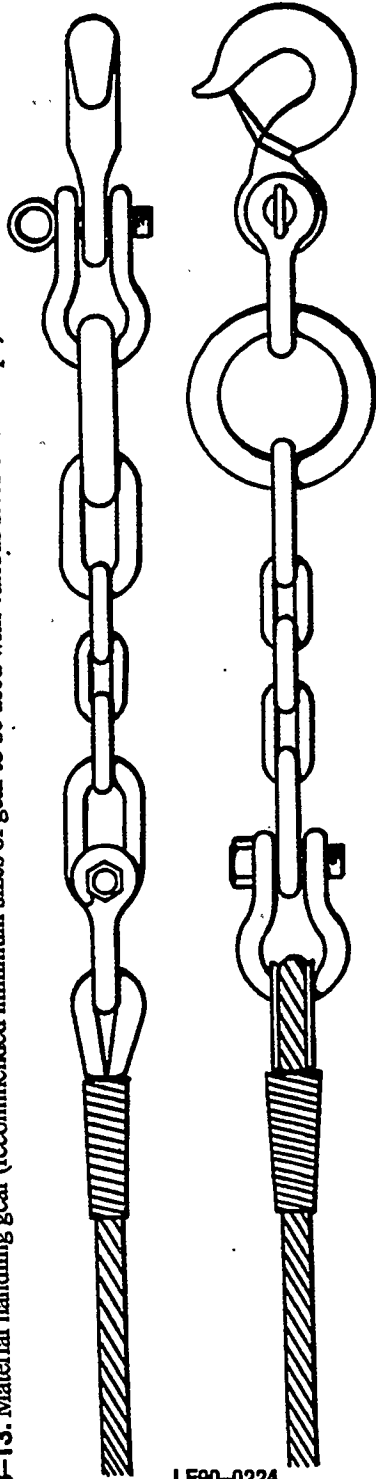

Improved Plow-Steel Wire Rope 6 strand; 19 wire Hemp Center	Safe load lb	New Wrought-iron Chain		Round-Pin or Screw Shackles		Drop-Forged Steel Hooks			Steel Rings and Links		
		Diameter of link stock in in.		Dia. of pin in in.		Diameter			Diameter stock		
		Diameter in in.		Screw pin	Round pin	Eye	Throat	Circle	Oblong	Triangle	
1/2	4,300	3/8	5/8	3/4	5/8	1 1/4	1 3/8	1	9/16	3/4	
9/16	5,400	9/16	3/4	3/4	3/4	1 3/8	1 1/2	1 1/4	5/8	7/8	
5/8	6,600	5/8	3/4	7/8	3/4	1 1/2	1 3/4	1 1/4	3/4	7/8	
3/4	9,400	3/4	7/8	1	7/8	1 3/4	2	1 1/2	1	1	
7/8	12,800	7/8	1 1/8	1 1/8	1 1/8	2 3/8	2 1/2	1 3/4	1 1/8	1 1/4	
1	16,000	1	1 1/4	1 1/4	1 1/4	2 3/4	3	2	1 1/4	1 1/2	
1 1/8	21,200	1 1/8	1 3/8	1 1/2	1 3/8	3 1/8	3 3/8	2 1/4	1 3/8	1 3/4	
1 1/4	26,000	1 1/4	1 1/2	1 5/8	1 1/2	3 1/2	4	2 1/4	1 1/2	1 3/4	
1 3/8	31,400	1 3/8	1 5/8	1 3/4	1 5/8	3 1/2	4	2 1/2	1 3/4	2	
1 1/2	37,000	1 1/2	2	2	2	4	4 1/2	2 3/4	1 3/4	2 1/4	

DEPARTMENT OF ENERGY HOISTING & RIGGING MANUAL	TITLE: WIRE ROPE, SLINGS, AND RIGGING ACCESSORIES NUMBER: 8.0 REV: 00/91
---	---

- c. Braided slings are made by braiding ordinary wire ropes together, thus making them more flexible than wire-rope slings. The size of a braided sling is determined by the diameter of one wire rope and the number of ropes in the cross section of the sling.
- d. Inspections
- (1) Ordinary Lifts
- (a) All slings shall be visually inspected each day they are used. In addition, an annual inspection shall also be performed. Annual inspections shall be performed by a qualified inspector. Any deterioration which could result in an appreciable loss of original strength shall be carefully noted, and determination made whether further use of the sling would constitute a safety hazard. Items for inspection are included in Exhibit I, "Rigging Tackle Annual Inspection (wire rope)," which appears at the end of this Section. Inspection records shall be kept on file and readily available.
- (b) No precise rules can be given for determination of the exact time for replacement of a sling, since many variable factors are involved. Safety in this respect depends largely upon the use of good judgment by an appointed or authorized person in evaluating remaining strength in a used sling, after allowance for deterioration disclosed by inspection. Safety of sling operation depends upon this remaining strength.
- (c) Conditions, such as the following, shall be sufficient reason for questioning sling safety and for consideration of replacement:
- (i) Six randomly distributed broken wires in one rope lay, or three broken wires in one strand in one rope lay
- (ii) Wear or scraping of one-third the original diameter of outside individual wires
- (iii) Kinking, crushing, birdcaging, or any other damage resulting in distortion of the rope structure
- (iv) Evidence of heat damage
- (v) End attachments that are cracked, deformed, or worn
- (vi) Hooks that have been opened more than 15% of the normal throat opening measured at the narrowest point, or twisted more than 10-degrees from the plane of the unbent hook
- (vii) Corrosion of the rope or end attachments
- (2) High-Consequence Lifts
- (a) All the provisions of 8.3.6.d(1) shall apply.
- (b) Slings in use for this service shall be inspected at least every 3 months. Slings not in regular use shall be inspected before use.

DRAFT

DEPARTMENT OF ENERGY HOISTING & RIGGING MANUAL	TITLE: WIRE ROPE, SLINGS, AND RIGGING ACCESSORIES NUMBER: 8.0 REV: 00/91
---	---

- (3) Special-High-Consequence Lifts
 - (a) All provisions of 8.3.6.d(1) shall apply.
 - (b) Slings in regular use shall be inspected at least once each month.
- e. Testing
 - (1) Ordinary Lifts
 - (a) Slings shall be certified as having been proof tested to 200% of the manufacturer's load rating prior to initial use. The test load shall be accurate to within -5%, +0% of stipulated values. Certification by the manufacturer is preferable, but, as an alternative, a pull test witnessed and certified by a qualified person is acceptable.
 - (b) Slings shall be load tested and inspected annually at their rated capacity by a qualified inspector. Load test records shall be kept on file and readily available. If a test has not been completed by the end of the required period, slings shall be downrated as follows:
 - (i) Thirty calendar days after the end of the period, the equipment shall be downrated to 75% of the rated capacity.
 - (ii) Sixty calendar days after the end of the period, the equipment shall be downrated to 50% of the rated capacity.
 - (iii) Ninety calendar days after the end of the period, the equipment shall be taken out of service until the required inspection has been completed.
 - (c) The sling may be tested by lifting a weight or by using a machine designed for the purpose. In any case, the test load shall be accurate within -5%, +0% of the required value.
 - (d) All slings shall have a rated capacity of 100% of the test load.
 - (e) There shall be no damage to parts or permanent deformation of any part as a result of load testing.
 - (2) High-Consequence Lifts
 - (a) Load tests shall be conducted at least once a year, before making a critical lift (if specified in the procedure), and if they have not been used in the previous six months unless the slings have been stored in bonded or controlled storage where they have been protected from the effects of weather or any other type of abuse. If a test has not been completed by the end of the required period, slings shall be downrated as per (b) above. Load test records shall be kept on file and readily available.
 - (b) Slings shall be visually inspected before and after load testing in accordance with the following:

DEPARTMENT OF ENERGY HOISTING & RIGGING MANUAL	TITLE: WIRE ROPE, SLINGS, AND RIGGING ACCESSORIES NUMBER: 8.0 REV: 00/91
---	---

- (i) Section 8.3.6.d for Wire-Rope Slings
- (ii) Section 8.3.7.k for Steel-Chain Slings
- (iii) Section 8.3.8.m for Metal-Mesh Slings
- (iv) Section 8.3.9.t for Synthetic-Mesh Slings
- (c) Load tests shall be no less than 150% of the maximum static load that will be encountered in service, and shall be accurate within -5%, +0% of stipulated values.
- (d) Test loads should be structured, by administrative control, to 150% of the maximum operational load anticipated in the following 12-month period, rather than routinely at 150% of the rated capacity.
- (3) Special-High-Consequences Lifts
 - All provisions of 8.3.6.e(2) shall apply.
- f. Operating Practices
 - (1) Ordinary Lifts
 - (a) Start and stop slowly; sudden starts and stops increase, out of all proportion to the load, the stresses in the crane ropes and the sling.
 - (b) Loads shall be set on blocks. Pulling a sling, from under a load which is resting on the sling, shall not be permitted.
 - (c) Wire-rope slings shall be protected against weather, chemicals, solvents, and high temperatures. The following temperatures shall not be exceeded:
 - (d) Fiber core ropes +93°C (200°F)
 - (e) Independent wire core ropes +240°C (400°F)
 - (f) Knotted slings shall not be used.
 - (g) Single-leg wire-rope slings shall not be used, unless proper precautions are taken to prevent suspended loads from rotating.
 - (h) Each leg of a wire-rope sling should be secure at the hook to prevent reeving of the sling through the hook.
 - (i) A complete turn of wire rope around the crane hook shall not be made.
 - (j) Protector arcs or blocking shall be used at sharp corners.
 - (k) Avoid handling hot material with wire-rope slings.
 - (l) Shackles or adjustable choker hooks should be used when making choker hitches.

DEPARTMENT OF ENERGY HOISTING & RIGGING MANUAL	TITLE: WIRE ROPE, SLINGS, AND RIGGING ACCESSORIES	REV: 00/91
	NUMBER: 8.0	

- (m) Slings should be stored on racks away from moisture and acids when not in use.
- (n) Damaged wire-rope slings shall be removed from service, discarded, and replaced with new slings.
- (o) Both prior to use and before storage, wire-rope slings shall be checked for:
 - Broken or cut wires or strands
 - Rust or corrosion
 - Kinks
 - Broken seizing wire
 - Damage to swaged fittings
 - Other signs of damage or abuse
- (p) The capacity of wire-rope slings is derated by the manufacturer by applying the efficiency factors in Figure 8-10.



Wire rope sprockets—spelter attachment.....100%



Wire rope sprockets—swaged.....100%



“Swaged-sleeve” loop or thimble attachment—
 1-in. diameter and smaller.....95%
 1 1/2-in. diameter and larger.....92.5%



Loop or thimble splice

1/4".....90%	1/2".....86%
5/16".....89%	5/8".....84%
3/8".....88%	3/4".....82%
7/16".....87%	7/8" & larger.....80%

LF90-0119

Figure 8-10. Splicing and fitting attachment method for wire rope. (Showing percentage of effective body strength permitted.)

DRAFT

- (q) Wire-rope slings made up using Crosby and/or double-based safety clips may be used in general purpose lifts provided they are installed properly, inspected, and tightened before making the lift.
- (r) When using Crosby clips, the rating of the sling must be derated to 80% of the wire rope rating to allow for the inefficiency of the clips.

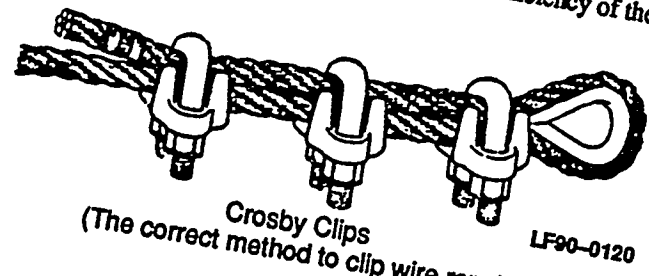

Crosby Clips
(The correct method to clip wire rope)

Figure 8-11. Crosby Clips (The right way to clip wire rope)

Note that the base of the clip bears against the live end of the wire rope, while the "U" of the bolt presses against the dead end.

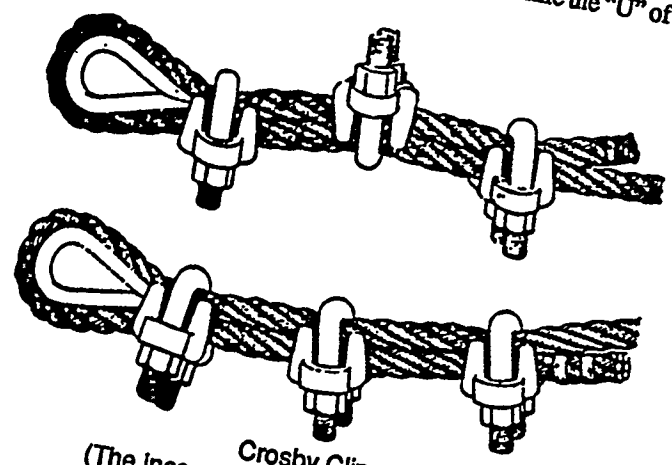

Crosby Clips
(The incorrect method to clip wire rope)

Figure 8-12. Crosby Clips (The wrong way to clip wire rope)

Note that the clips should not bear against the live end of the wire rope, because of the possibility of the rope being cut.



Figure 8-13. Double-based safety clips (drop-forged steel, galvanized).

- (s) Double-based safety clips (Fist Clips) may be used to make up general purpose slings, provided the sling is derated to 95% of wire rope capacity.
- (t) The number of clips required and the spacing are the same as for the Crosby clips.

Table 8-14. Number of U type clips and torque for wire rope eye loop connections

Rope diameter (inches) and nominal Clip Size	Number of Clips	Torque to be applied to nuts of clips (ft-lbs.)	
		Minimum ...	Maximum
5/16	3	22	25
3/8	3	35	40
7/16 & 1/2	3	50	60
5/8	3	100	110
3/4	4	115	125
7/8 thru 1	4	210	230
1 1/8	5	210	230
1 1/4 & 1 3/8	5	360	380
1 1/2	6	530	560

NOTE 1: Properly applied U clip connection develops only 80 per cent of rope strength.

NOTE 2: The spacing of clips should be six times the wire rope diameter and the U portion of the clip shall always be on the dead end of the rope.

- (u) All wire-rope slings in DOE-controlled areas shall be marked, as a minimum, with a serial number. The serial number may be stenciled or stamped on a metal tag affixed to the sling, or it may be stenciled or stamped on the swages of a sling eye.
- (v) Through this serial number, the special-rated capacity and the load-test date shall be readily available to the user of the sling. Additional information, such as shop location, size, and length can also be made available.

DRAFT

**TITLE: WIRE ROPE, SLINGS, AND RIGGING
ACCESSORIES**

NUMBER: 8.0

REV: 00/91

- (w) Where slings have more than one leg, the serial number shall be on the master link. The serial number may be stamped on the master link providing the stamping does not affect the sling capacity.
- (2) High-Consequence Lifts:
- (a) All provisions of 8.3.6.f(1) shall apply.
 - (b) Eyes in wire rope shall be made with a thimble having a ratio of thimble diameter (D) to rope diameter (d) of 3. $D/d = 3$ or more.
 - (c) The dead end of the eye must be spliced to the body by either a hand-tucked splice or a swaged sleeve.
 - (d) Wedge sockets or wire-rope clips shall not be used on slings used in High-Consequence/Special-High-Consequence Lifts.
 - (e) Multiple-leg slings shall have a link or ring at the crane-hook contact, to prevent running of the sling over the hook and to prevent sharp bending of the sling eye.
 - (f) The working loads of wire-rope slings shall not exceed their special-rated capacities.
 - (g) Slings shall not be spliced together.
 - (h) Slings joined end-to-end shall use thimble eyes and fittings as shown in Figure 5-2.
 - (i) Sling eyes should be located so that:
 - (i) Adequate clearance is maintained between the attached slings and other parts or surfaces of the component or equipment.
 - (ii) There is no interference with the functioning of hoisting, rigging, or handling equipment.
 - (iii) Maximum accessibility to the eye is maintained.
 - (iv) Attached slings can converge over the center of gravity of the lift when at its maximum shipping weight.
 - (v) Proper stability can be maintained during lifting and positioning of the item at the installation site.
 - (vi) The plane of the slinging eye is coincident with the plane of the sling under loaded conditions within ± 5 degrees.
 - (vii) Sling angles are not less than 45 degrees with the horizontal.
 - (j) Inside dimensions or clearances of slinging eyes shall be as listed below, except where the eyes engage shackles which are permanently attached to the equipment (in which case the inside clearance of the shackles shall be as listed below, and

the inside clearance of the slinging eye shall be sufficient to permit free movement of the shackle).

<u>Weight of Equipment (tons)</u>	<u>Inside Dimension of Eye or Shackle (inches)</u>
Up to 20	3 minimum, 3.5 maximum
20 to 45	3.5 minimum, 4 maximum
45 to 65	4 minimum, 5 maximum
Over 65	Based on hook dimension

(k) Wire-rope slings used in High-Consequence Lifts shall, as a minimum, be marked as in 5.6.1c. As determined on a case basis, the reach, type, weight of the sling assembly, and special-rated capacity may also be required.

(3) **Special-High-Consequence Lifts:**

- (a) All provisions of 8.3.6.f(2) shall apply.
- (b) Slings must be identified by serial number, reach, type, weight of the sling assembly, and special-rated capacity (at a specific angle with the horizontal).
- (c) Open-loop slings shall not be used to handle Special-High-Consequence Loads.
- (d) Rigging diagrams are mandatory.
- (e) A written history of each use is mandatory. The records required for Special-High-Consequence Lifts are considered adequate to satisfy this requirement.

8.3.7 Steel-Chain Slings

- a. Chain slings differ from wire-rope slings in that components using wire are replaced by link chain. Other sling components are similar. Chain slings are more rugged and flexible, but less shock resistant than wire-rope or braided slings. The size is measured by the link stock.
- b. Two basic types, with many variations, are used: basket-type and hook-type. An example of each is shown.

MENT OF
 & RIGGING

TITLE: **WIRE ROPE, SLINGS, AND RIGGING
 ACCESSORIES**

NUMBER: **8.0**

REV: **00/91**

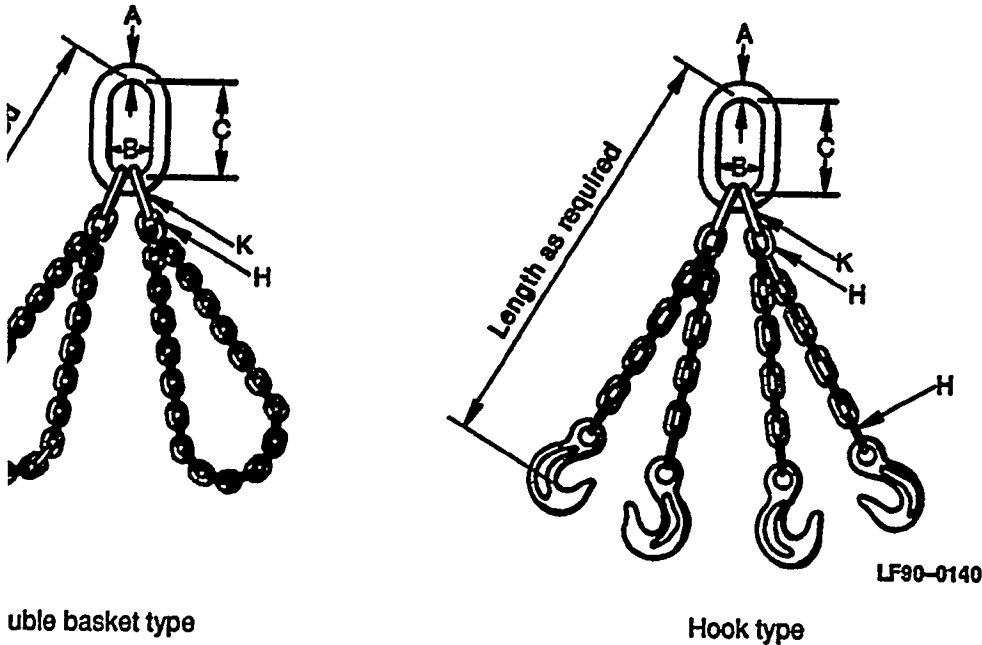

Double basket type

Hook type

Figure 8-14. Types of Chain Slings.

- c. Alloy steel chain slings shall not be heated above 1000°F after being received from the manufacturer.
- d. When exposed to service temperatures in excess of 600°F, working load limits shall be reduced in accordance with the chain manufacturer's recommendations.
- e. Extremely low temperatures (<0°F) may cause brittle fractures. Under these conditions, sudden loading should be avoided and the load should be lifted a very short distance while the chains are carefully inspected.
- f. All chains shall be manufactured and tested by the chain manufacturer in accordance with ASTM A391 (Section 9.0).
- g. Chains should be stored in racks or in designated locations when not in use. Chains should never be stored in damp or dirty places, nor in places exposed to the weather. For long-term storage, they should receive a coating of oil. The ends of all empty chains should be hooked onto the hoist hook or bull ring.
- h. Chains should not be lubricated when in use, since this might make them dangerous to handle. Chains should be cleaned periodically to remove abrasive grit and to facilitate inspection.
- i. The total load which can be lifted safely with steel chain depends upon the manner in which the slings are attached to the load. If all legs of a steel-chain sling are hooked back into the

DRAFT

master link, the safe-load capacity of the whole sling may be increased by 100% if the capacity of the master link is not exceeded.

- j. The safe-load level on any chain sling is a function of three basic factors: size and number of legs, condition of chain and other component, and hooking angle between legs and horizontal. Table 8-15 shows safe loads in lb per leg which can be carried by various chain-sling arrangements. Note the effect of very-low-hook height and wide-leg spreads.
- k. In cases where three or more legs of a chain are used, it shall be assumed that the load will be carried by only three legs; this includes the double-basket type.

Table 8-15. Safe loads for alloy steel chain slings

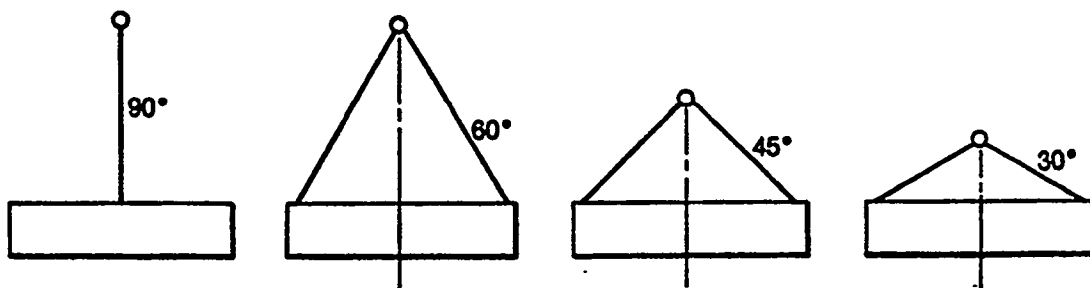

LF90-0220

Size (in.)	90°	60°	45°	30°
9/32	3 250	2 800	2 300	1 625
3/8	6 600	5 700	4 650	3 300
1/2	11 250	9 750	7 950	5 625
5/8	16 500	14 300	11 650	8 250
3/4	23 000	19 900	16 250	11 500
7/8	28 750	24 900	20 350	14 375
1	38 750	33 550	27 400	19 375
1 1/8	44 500	37 550	31 450	22 250
1 1/4	57 500	49 800	40 650	28 750

1. Inspections

(1) Ordinary Lifts

- (a) All slings shall be visually inspected each day before they are used.
- (i) Conduct a link-by-link inspection for the following defects: bent links, stretched links, cracks in any section of link, scores, abrasions, or markings tending to weaken the rings or hooks. Reject if discovered.
- (ii) Check rings and hooks for distortion, cracks in weld areas, corrosion, and scores, or markings tending to weaken the ring or hooks. Reject if discovered.

DRAFT

**DEPARTMENT OF
ENERGY
HOISTING & RIGGING
MANUAL**

**TITLE: WIRE ROPE, SLINGS, AND RIGGING
ACCESSORIES**

NUMBER: 8.0

REV: 00/91

- (iii) Inspection shall be made on an individual link basis. If any link does not hinge freely with the adjoining link, the assembly shall be removed from service.
 - (iv) Assemblies with deformed master links or coupling links shall be removed from service.
 - (v) Assemblies shall be removed from service if hooks have been opened more than 15% of the normal throat opening measured at the narrowest point, or twisted more than 10-degrees from the plane of the unbent hook.
 - (vi) Deformed hooks or other attachments should not be straightened on the job. Assemblies with such defects shall be reconditioned by the manufacturer.
 - (vii) Assemblies with cracked hooks or other end attachments shall be removed from service.
 - (viii) Assemblies with such defects shall be reconditioned or repaired prior to return to service.
 - (ix) See Exhibit II, "Rigging Tackle Annual inspection (chain)," which appears at the end of this Section.
- (b) Annual inspections shall be conducted by a qualified inspector. The criteria in (a) above, and the following shall be used to make the inspections:
- (i) Hang chain in a vertical position, if practicable, for preliminary inspection. Chain should hang reasonably straight if links are not distorted.
 - (ii) Measure accurately the reach (inside of crane ring to inside of hook) under no load when new and at each inspection, and keep a record of increase in length. Increase in length may be due to stretch (sign of overload or wear, lack of lubrication, or too low a rating for class of service).
 - (iii) Check for localized stretch or wear. Lift each link from its seat and visually inspect for grooving. If grooving is noticed, check stock diameter of link to be within the minimum safe dimensions in the table below. Reject chain if it does not meet the requirements in the table.
 - (iv) If wear at any point of any chain link exceeds that shown in Table 8-16, the assembly shall be removed from service.
 - (v) Sharp transverse nicks should be rounded out by grinding.
 - (vi) If the depth of the gauge or rounded-out portion exceeds the values shown in the following table, the assembly shall be removed from service.
- (2) High-Consequence Lifts
- (a) All the provisions of 8.3.7.a(1) shall apply.

DRAFT

DEPARTMENT OF ENERGY HOISTING & RIGGING MANUAL	TITLE: WIRE ROPE, SLINGS, AND RIGGING ACCESSORIES	REV: 00/91
	NUMBER: 8.0	

Table 8-16. Maximum allowable wear of chains

Chain size (in.)	Original size (in.)	Maximum permissible wear (in.)	Remove from service dimension* (in.)
1/4	9/32	3/64	15/64
3/8	13/32	7/64	19/64
1/2	17/32	9/64	25/64
5/8	21/32	11/64	31/64
3/4	25/32	3/16	19/32
7/8	29/32	13/64	45/64
1	1 1/32	15/64	51/64
1 1/4	1 1/4	1/4	1
1 1/2	1 1/2	19/64	1 13/64
1 3/4	1 3/4	5/16	1 7/16
2	2	21/64	1 43/64

*When smallest section of link is less than these dimensions.

- (b) Slings in use for this service shall be inspected at least every three months. Slings not in regular use shall be inspected before use.

(3) Special-High-Consequence Lifts

- (a) All provisions of 8.3.7.l(2) shall apply.

- (b) Slings in regular use shall be inspected at least once each month.

l. Testing

All provisions of 8.3.6.e shall apply.

m. Operating Practices

(1) Ordinary Lifts

- (a) Overloading causes accidents. When in doubt, use a larger sling.
- (b) Loads shall be set on blocks. Setting a load on a sling or pulling a sling from under a load is not permitted. Place wooden blocks under the load high enough to clear the chain.
- (c) Shortening of chain slings shall be accomplished by hooking back into the chain, into the master link, or with grab hooks. Shortening by knotting, twisting, bolting, or inserting the tip of the hook into a link shall not be permitted.
- (d) A chain shall not be hammered to force it into position.
- (e) Chain slings shall be protected from sharp corners which might bend the links. A suitable pad shall be used to prevent gouging or bending of the chain links, as well as possible scarring of the load.

DRAFT

- (f) When making choker hitches with chain slings, always face the hook opening out and away from the pull of the sling, so that the hooks will not slip out when slack is taken out of the sling.

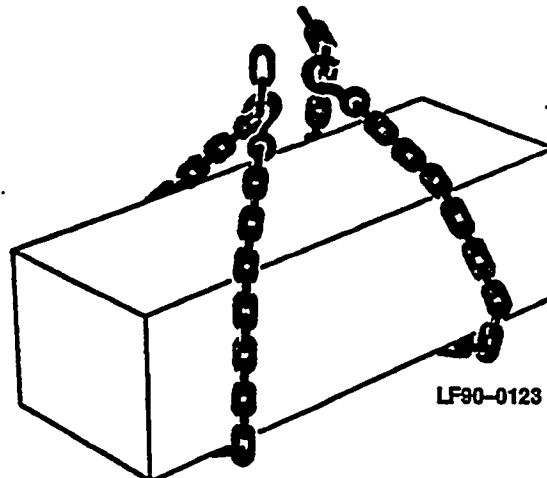

Choker hitches with chain slings
(hook opening away from pull of sling)

Figure 8-15. Choker Hitches with Chain Slings (Hook opening away from pull of sling)

- (g) Steel-chain slings shall be checked for:
- (i) Nicks, cracks, gouges, and wear
 - (ii) Bending, stretching, or shearing of links
 - (iii) Open hooks
 - (iv) Rust and corrosion
 - (v) Uneven lengths when sling legs are hanging free
- (h) Welding and local repairs of sling chains shall not be made. All defective chains should be returned, through formal procedure, to the vendor for examination; repair, and recertification.
- (i) Sudden loading of chain slings shall be avoided.
- (j) Safety snaps on hooks shall be maintained in good condition.
- (k) Do not take chances. If a chain does not look safe, it must not be used. Do not assume a chain is safe because it looks new; look for stretched links. If in doubt, check with the supervisor.
- (l) Loads shall not be carried on the point or tip of a hook.

DEPARTMENT OF ENERGY HOISTING & RIGGING MANUAL	TITLE: WIRE ROPE, SLINGS, AND RIGGING ACCESSORIES
	NUMBER: 8.0 REV: 00/91

- (m) Avoid unbalanced loads.
 - (n) Homemade links, make-shift fasteners formed from bolts, rods, etc., or other such attachments shall not be used.
 - (o) The ends of all empty chains shall be hooked onto the hoist hook or bull ring.
 - (p) Make-shift and field-fabricated hooks shall not be used on steel-chain slings.
 - (q) All steel-chain slings in DOE-controlled areas shall be identified, as a minimum, with a serial number. This serial number shall be stenciled or stamped on a metal tag affixed to the sling.
 - (r) Through this serial number, the special-rated capacity and the load-test date shall be readily available to the user of the sling. Additional information, such as shop location, size, and length can also be made available.
 - (s) Where slings have more than one leg, the serial number shall be on the master link. The serial number may be stamped on the master link providing the stamping does not affect the sling capacity.
- (2) High-Consequence Lifts:
- (a) All provisions of 8.3.7.m(1) shall apply.
 - (b) Multiple-leg slings shall use a link or ring at the crane-hook contact to prevent running of the chain over the hook to prevent sharp bending of the chain links.
 - (c) The working load shall not exceed the special-rated capacity of the chain sling.
 - (d) Chains shall not be hooked together to increase the length of the chain sling.
 - (e) Steel-chain slings shall, as a minimum, be marked as in (q) above. As determined on a case basis, the reach, type, weight of the sling assembly, and special-rated capacity may also be required.
- (3) Special-High-Consequence Lifts:
- (a) All provisions of 8.3.7.m(2) shall apply.
 - (b) Slings must be identified by serial number, reach, type, weight of the sling assembly, and special-rated capacity (at a specified angle with the horizontal).
 - (c) Open-loop slings shall not be used.
 - (d) Rigging diagrams are mandatory.
 - (e) A written history of each use is mandatory. The records required for Special-High-Consequence Lifts are considered adequate to satisfy this requirement.

**DEPARTMENT OF
ENERGY
HOISTING & RIGGING
MANUAL**

**TITLE: WIRE ROPE, SLINGS, AND RIGGING
ACCESSORIES**

NUMBER: 8.0

REV: 00/91

8.3.8 Metal-Mesh Slings

- a. Metal-mesh slings shall be classified in accordance with the following:

<u>Type</u>	<u>Classification</u>	<u>Designation</u>
Heavy Duty	Carbon Steel	35-CS
	Stainless Steel	35-SS
Medium Duty	Carbon Steel	43-CS
	Stainless Steel	43-SS
Light Duty	Carbon Steel	59-CS
	Stainless Steel	59-SS

- b. The carbon steel used in metal-mesh slings shall be processed to produce the required mechanical properties.
- c. The material used for stainless steel metal-mesh slings shall conform, at least, to the AISI standards for Type-302 or Type-304 stainless steel (see Section 10.0).
- d. Other materials may be used. When metal-mesh slings are produced from such materials, the sling manufacturer should be consulted for specific data.
- e. The handle shall be designed to ensure:
- (1) At least the same rated capacity as the fabric
 - (2) No visible permanent deformation after proof testing.
- f. The fabric and handles shall be so joined that:
- (1) The rated capacity of the sling is not reduced
 - (2) The load is evenly distributed across the width of the fabric
 - (3) Sharp edges do not damage the fabric.
- g. Slings may be painted, plated, impregnated with elastomers, such as neoprene or polyvinyl chloride (PVC), or otherwise suitably coated. The coating shall not diminish the rated capacity of a sling.
- h. The factor of safety for metal-mesh slings shall be a minimum of 5.
- i. Slings shall not be used to lift loads in excess of the special-rated capacity, properly derated for other than straight-pull configurations.
- j. All slings covered by this section may be used without derating in a temperature range from -20 to +550°F, except elastomer-impregnated slings.
- k. All slings covered by this section and impregnated with PVC or neoprene shall be used only in a temperature range from 0 to +200°F.

DRAFT

DEPARTMENT OF ENERGY HOISTING & RIGGING MANUAL	TITLE: WIRE ROPE, SLINGS, AND RIGGING ACCESSORIES NUMBER: 8.0 REV: 00/91
---	---

- For operation at temperatures outside these ranges or for other impregnations, the manufacturer should be consulted for specific data.

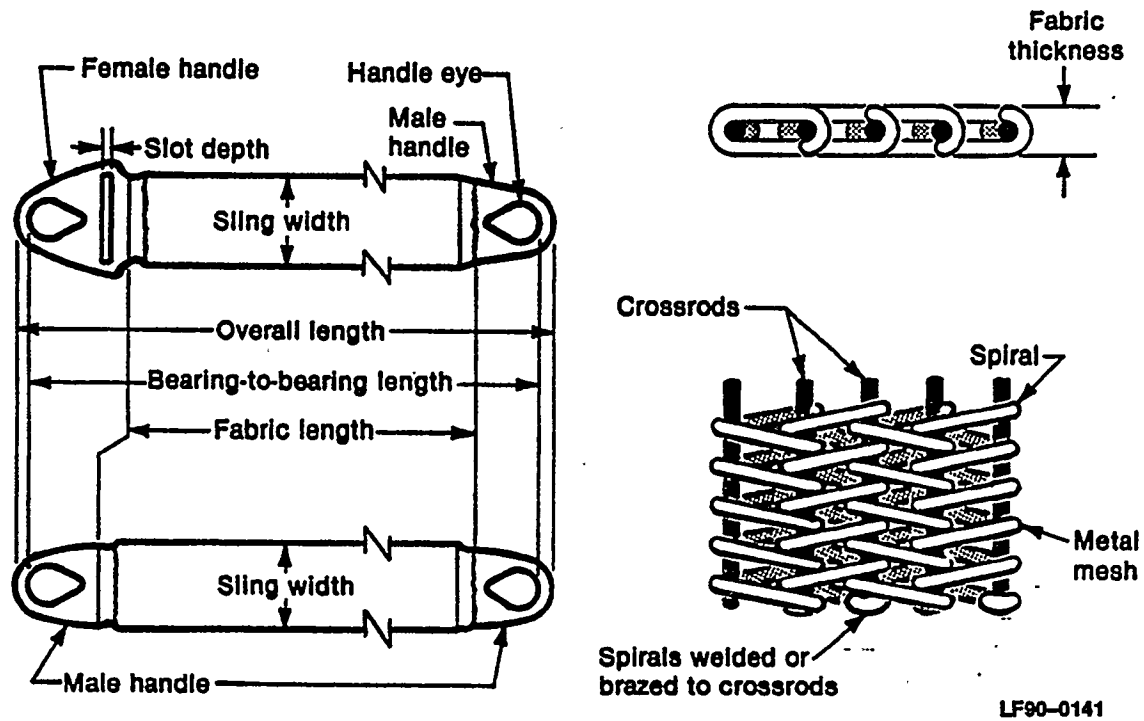
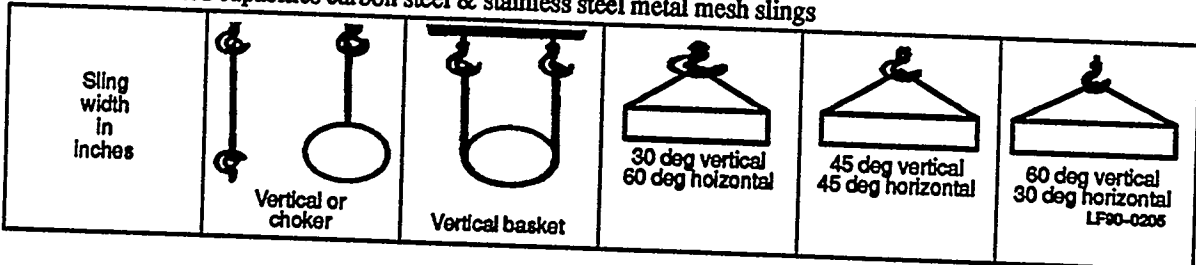

Figure 8-16. Typical Metal-Mesh Sling.

DEPARTMENT OF ENERGY HOISTING & RIGGING MANUAL	TITLE: WIRE ROPE, SLINGS, AND RIGGING ACCESSORIES
	NUMBER: 8.0
REV: 00/91	

Table 8-17. Rated capacities carbon steel & stainless steel metal mesh slings



Heavy duty 10-ga 35 spirals/ft of sling width

2	1,500	3,000	2,600	2,100	1,500
3	2,700	5,400	4,700	3,800	2,700
4	4,000	8,000	6,900	5,600	4,000
6	6,000	12,000	10,400	8,400	6,000
8	8,000	16,000	13,800	11,300	8,000
10	10,000	20,000	17,000	14,100	10,000
12	12,000	24,000	20,700	16,900	12,000
14	14,000	28,000	24,200	19,700	14,000
16	16,000	32,000	27,700	22,600	16,000
18	18,000	36,000	31,100	25,400	18,000
20	20,000	40,000	34,600	28,200	20,000

Medium duty 12-ga 43 spirals/ft of sling width

2	1,350	2,700	2,300	1,900	1,400
3	2,000	4,000	3,500	2,800	2,000
4	2,700	5,400	4,700	3,800	2,700
6	4,500	9,000	7,800	6,400	4,500
8	6,000	12,000	10,400	8,500	6,000
10	7,500	15,000	13,000	10,600	7,500
12	9,000	18,000	15,600	12,700	9,000
14	10,500	21,000	18,200	14,800	10,500
16	12,000	24,000	20,800	17,000	12,000
18	13,500	27,000	23,400	19,100	13,500
20	15,000	30,000	26,000	21,200	15,000

Light duty 14-ga 59 spirals/ft of sling width

2	900	1,800	1,600	1,300	900
3	1,400	2,800	2,400	2,000	1,400
4	2,000	4,000	3,500	2,800	2,000
6	3,000	6,000	5,200	4,200	3,000
8	4,000	8,000	6,900	5,700	4,000
10	5,000	10,000	8,600	7,100	5,000
12	6,000	12,000	10,400	8,500	6,000
14	7,000	14,000	12,100	9,900	7,000
16	8,000	16,000	13,900	11,300	8,000
18	9,000	18,000	15,600	12,700	9,000
20	10,000	20,000	17,000	14,100	10,000

**DEPARTMENT OF
ENERGY
HOISTING & RIGGING
MANUAL**

**TITLE: WIRE ROPE, SLINGS, AND RIGGING
ACCESSORIES**

NUMBER: 8.0

REV: 00/91

m. Inspections

(1) Ordinary Lifts

- (a) All slings shall be visually inspected before each use by the person handling the sling.
- (b) Annual inspections shall be made by a qualified inspector and inspection records shall be kept on file and readily available
- (c) Slings shall be inspected and shall be removed from service if any of the following defects are present:
 - (i) A broken weld or brazed joint along the sling edge
 - (ii) A broken wire in any part of the mesh
 - (iii) Reduction in wire diameter of 25% due to abrasion, or 15% due to corrosion
 - (iv) Lack of flexibility due to distortion of the fabric
 - (v) Distortion of the female handle so the depth of the slot is increased by more than 10%.
 - (vi) Distortion of either handle so the width of the eye is decreased by more than 10%.
 - (vii) A 15% reduction of the original cross-sectional area of metal at any point around a handle eye.
 - (vii) Any distortion of either handle out of its plane.

(2) High-Consequence Lifts

All provisions of 8.3.8.m(1) shall apply.

Slings in use for this service shall be inspected at least every three months. Slings not in regular use shall be inspected before use. Standards for these inspections shall be as in 8.3.8.m(1)(c).

Hooks shall be examined annually by an NDE method in accordance with the sections of ASTM Standards, applicable to the method of examination used.

(3) Special-High-Consequence Lifts

All provisions of 8.3.8.m(2) shall apply.

Slings in regular use shall be inspected at least once each month in accordance with the standards in 8.3.8.m(1)(c).

n. Testing

DRAFT

**DEPARTMENT OF
ENERGY
HOISTING & RIGGING
MANUAL****TITLE: WIRE ROPE, SLINGS, AND RIGGING
ACCESSORIES****NUMBER: 8.0****REV: 00/91**

All provisions of 8.3.6.e shall apply.

o. Operating Practices

(1) Ordinary Lifts

- (a) Approximate weight of the load shall be determined.**
- (b) Sling shall have suitable characteristics and rated capacity for the load and environment.**
- (c) Sling should be long enough to provide the maximum practical angle between the sling leg and the horizontal (minimum practical angle at the crane hook, if vertical angles are used).**
- (d) Slings shall not be shortened with knots, bolts, or other unapproved methods.**
- (e) Damaged slings shall not be used.**
- (f) Slings shall be hitched securely to the load.**
- (g) Sharp corners shall be padded.**
- (h) Hands and fingers shall be kept from between the sling and the load.**
- (i) Personnel shall stand clear of the suspended load.**
- (j) Shock loading should be avoided.**
- (k) Slings shall not be pulled from under a load when the load is resting on the sling.**
- (l) Slings shall be stored in an area where they will not be subjected to mechanical damage or corrosive action.**
- (m) Twisting and kinking of the legs should be avoided.**
- (n) In a choker hitch, slings shall be long enough so that the female handle chokes freely on the mesh and never on the handle.**
- (o) In a choker hitch, the load should be balanced. When this cannot be done, the manufacturer should be consulted for a derating factor, or for other means of handling this type of load.**
- (p) In a basket hitch, the load shall be balanced to prevent slippage.**
- (q) Slings in which the spirals are locked or without free articulation shall not be used.**
- (r) Never hammer a sling to straighten a spiral or cross rod, or to force a spiral into position.**
- (s) Slings used in pairs should be attached to a spreader beam.**

DRAFT

**TITLE: WIRE ROPE, SLINGS, AND RIGGING
ACCESSORIES**
NUMBER: 8.0

REV: 00/91

(t) All metal-mesh slings shall have a permanently affixed, durable identification tag containing the following information:

- (i) Manufacturer's name or trademark
- (ii) Serial number

Through this serial number, the special-rated capacity (at specified angle with the horizontal), rated capacity in vertical, basket, and choker hitch, and the load-test date shall be readily available to the user of the sling. Additional information, such as shop location, size, and length can also be made available.

(2) High-Consequence Lifts:

- (a) All provisions of 8.3.8.o(1) shall apply.
- (b) Do not exceed special-rated capacity.
- (c) Rigging diagrams may be required on a case by case basis.
- (d) Slings used in High-Consequence Lifts shall, as a minimum, be marked as in (t) above. As determined on a case basis, the reach, type, and weight of the sling assembly may also be required.

(3) Special-High-Consequence Lifts:

- (a) All provisions of 8.3.8.o(2) shall apply.
- (b) Rigging diagrams are mandatory.
- (c) A written history of each use is mandatory. The records required for Special-High-Consequence Lifts are considered adequate to satisfy this requirement.
- (d) Segregated storage is mandatory.
- (e) In addition to the requirements of (t) above, slings shall also be identified by reach, type, and weight of sling assembly.

8.3.9 Synthetic-Mesh Slings

- a. Mesh shall possess the following qualities:
 - (1) Sufficient strength to meet the sling manufacturer's requirements
 - (2) Uniform thickness and width
 - (3) Have selvage edges and not be split from its woven width.
- b. The thread used in the manufacture of a sling shall be of the same type material as the mesh.
- c. Fittings shall be:

**DEPARTMENT OF
ENERGY
HOISTING & RIGGING
MANUAL**

**TITLE: WIRE ROPE, SLINGS, AND RIGGING
ACCESSORIES**

NUMBER: 8.0

REV: 00/91

- (1) Of sufficient strength to sustain twice the rated capacity without permanent deformation
- (2) Of a minimum breaking strength equal to that of the sling
- (3) Free of all sharp edges that would in any way damage the mesh.
- d. The stitch pattern shall contain a sufficient number of stitches to develop the full breaking strength of the sling.
- e. Slings may be coated with elastomers or other suitable material that will impart desirable characteristics, such as abrasion resistance, sealing of pores, and increased coefficient of friction.
- f. The factor of safety for synthetic-mesh slings shall be a minimum of 5.
- g. Rated capacities are affected by the type of hitch used, and by the angle from the vertical when used as multi-legged slings or in basket hitches. The sling manufacturer shall supply data on these effects.
- h. Slings shall not be used to lift loads in excess of the special-rated capacity, properly derated for other than straight-pull configuration.
- i. Slings shall be stored in a manner such that mechanical or chemical damage is prevented.
- j. Nylon slings shall not be used where acid conditions exist.
- k. Polyester and polypropylene slings shall not be used where caustic conditions exist.
- l. Polyester and nylon slings shall not be used at temperatures in excess of 180°F, nor polypropylene slings in excess of 200°F.
- m. Aluminum fittings shall not be used where caustic conditions exist.
- n. Synthetic webbing slings offer a number of advantages for rigging purposes:
 - (1) Their relative softness and width mean they have much less tendency to mar or scratch finely machined, highly polished or painted surfaces and have less tendency to crush fragile objects than do fiber rope, wire rope or chain slings.
 - (2) Because of their flexibility, they tend to mold themselves to the shape of the load.
 - (3) They are not affected by moisture and certain chemicals.
 - (4) They do not rust and thus do not stain ornamental precast concrete or stone.
 - (5) They are non-sparking and can be used safely in explosive atmospheres.
 - (6) They minimize twisting and spinning during lifting.

Their light weight permits ease of rigging, their softness precludes hand cuts, and the danger of harm from a bump by a free-swinging sling is minimal.

They are elastic and stretch under load more than either wire rope or chain and are thus able to absorb heavy shocks and cushion the load. In cases where sling stretching must be minimized, a sling of larger load capacity or a polyester sling should be used.

DRAFT

**DEPARTMENT OF
ENERGY
HOISTING & RIGGING
MANUAL**

**TITLE: WIRE ROPE, SLINGS, AND RIGGING
ACCESSORIES**

NUMBER: 8.0

REV: 00/91

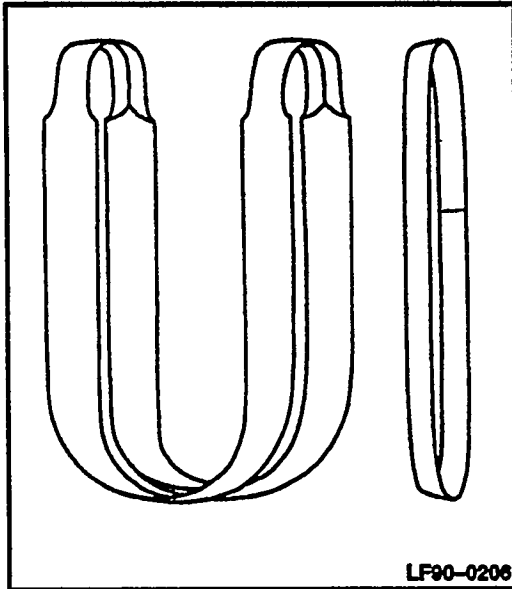

Figure 8-18. Endless or grommet sling

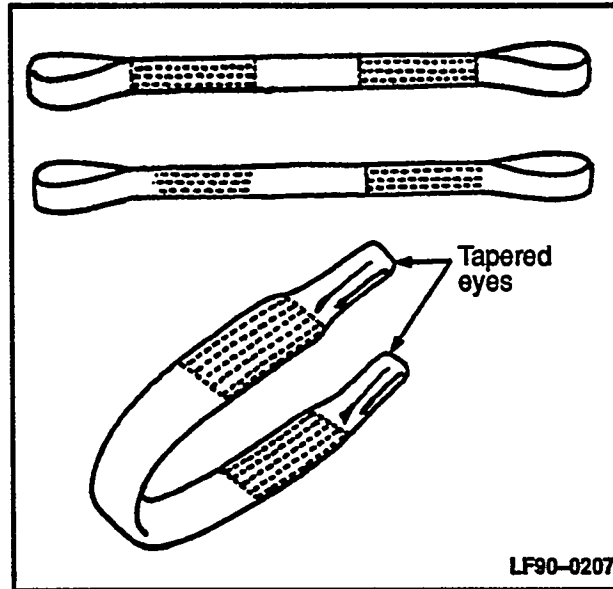

Figure 8-19. Standard eye and slings

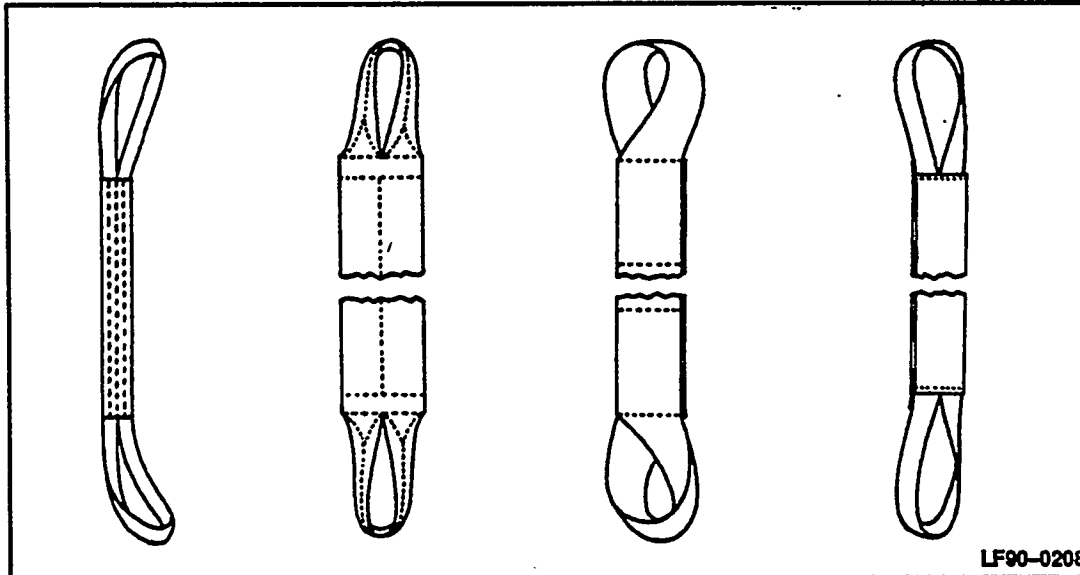

Figure 8-20. Twisted eye slings

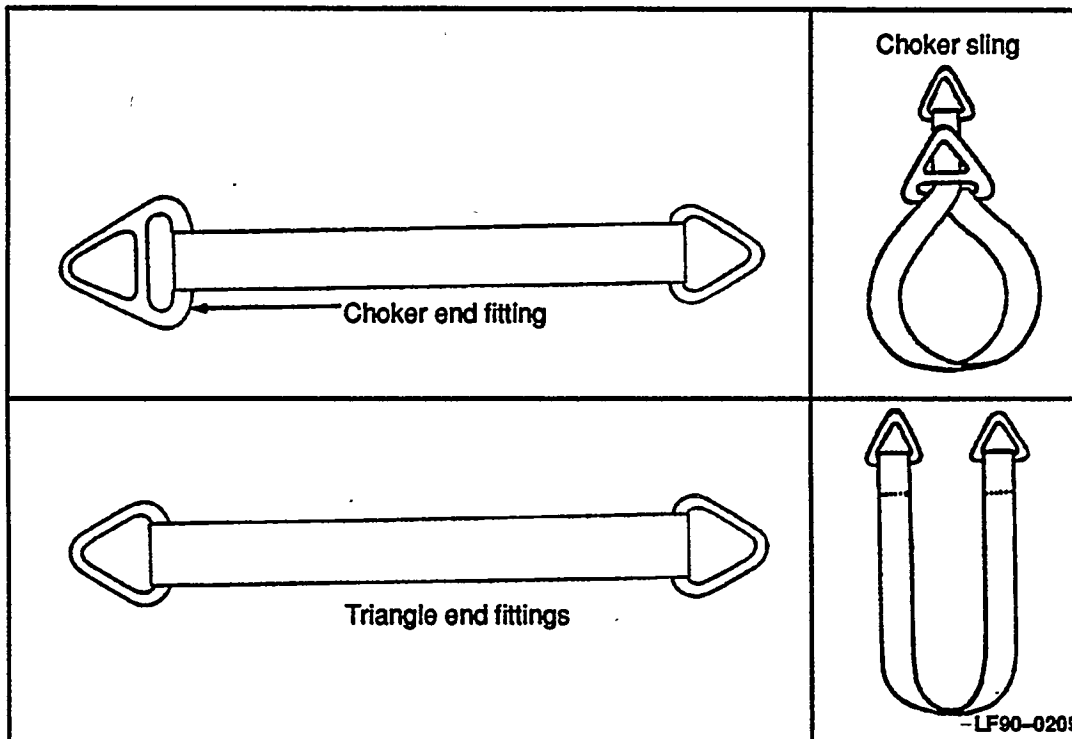
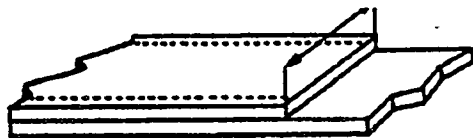

Figure 8-20. Metal end fittings.



REGULAR. This is the type that is sewn on to give fixed protection at expected wear points. They can be sewn anywhere on the sling, at any length on one side or on both sides.



EDGE GUARD. A strip of webbing or leather is sewn around each edge of the sling. This is necessary for certain applications where the sling edges are subject to damage.

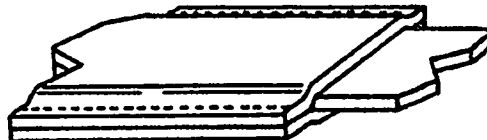

SLEEVE. Sometimes called sliding sleeve or tube type wear pads, these pads are ideal for handling material with sharp edges because the sleeve doesn't move when the sling stretches and adjusts to the load. Sleeves cover both sides of the sling and can be shifted to points of expected maximum wear.

LF90-0216





Figure 8-21. Web and edge protectors.

DEPARTMENT OF ENERGY HOISTING & RIGGING MANUAL	TITLE: WIRE ROPE, SLINGS, AND RIGGING ACCESSORIES NUMBER: 8.0 REV: 00/91
---	---

- r. The sling capacities quoted in Tables 8-18, 8-19 and 8-20 are approximate only and are based on nylon webbing having breaking strengths of 8000 lb/in. of webbing width and 6000 lb/in. of width and Dacron having a breaking strength of 5000 lb/in. of webbing width. The capacities are also based on a 5:1 factor of safety and assume that the end fittings are of adequate strength.
- s. Although safe working loads for bridle hitches in the choker or double basket configuration hitches are provided, it is advised that they be used only with extreme caution because as the sling angle decreases one edge of the web will take all the load with risk of tearing. (Figure 8-22)
- t. Inspections
- (1) Ordinary Lifts
- (a) All slings shall be visually inspected before each use by the person handling the sling.
- (b) Annual inspection shall be made by a qualified inspector and inspection records shall be kept on file and readily available.
- (c) A sling shall be removed from service if any defects, such as the following, are visible:
- (i) Acid or caustic burns
- (ii) Melting or charring of any part of the surface
- (iii) Snags, punctures, tears, or cuts
- (iv) Broken or worn stitches
- (v) Wear or elongation exceeding the amount recommended by manufacturers
- (vi) Distortion of fittings
- (vii) Other apparent defects which cause doubt as to the strength of the sling should be referred to the manufacturer for determination.
- (viii) See Exhibit III, "Rigging Tackle Periodic Inspection (Nonmetallic Slings & Ropes," which appears at the end of this section.
- (d) Written inspection records, utilizing the identification for each sling as established by the user, should be kept on all slings. These records should show a description of the new sling and its condition on each subsequent annual inspection.
- (2) High-Consequence Lifts
- (a) All provisions of 8.3.9.t(1) shall apply.
- Slings in use for this service shall be inspected at least every three months. Slings not in regular use shall be inspected before use. Standards for these inspections shall be as in 8.3.9.t(1)(c).

DEPARTMENT OF ENERGY HOISTING & RIGGING MANUAL	TITLE: WIRE ROPE, SLINGS, AND RIGGING ACCESSORIES
	NUMBER: 8.0 REV: 00/91



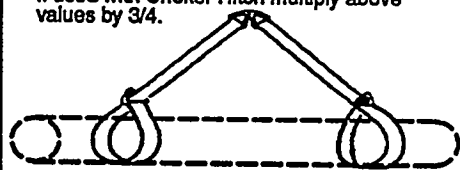
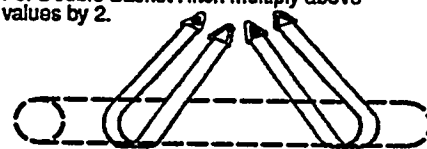

Table 8-18. Rated capacity of Dacron web slings (5000 lb/in.)

DACRON WEB SLINGS (5000 lb/in. Material)						
Web Width (in.)	Maximum Safe Working Loads—lb (safety factor = 5) (eye & eye, twisted eye, triangle fittings, choker fittings)					
	Single Vertical Hitch 	Single Choker Hitch 	Single Basket Hitch (Vertical Legs) 	2-Leg Bridle Hitch & Single Basket Hitch With Legs Inclined  LF90-0211		
				60°	45°	30°
1	1,000	750	2,000	1,730	1,400	1,000
2	2,000	1,500	4,000	3,460	2,830	2,000
3	3,000	2,250	6,000	5,200	4,250	3,000
4	4,000	3,000	8,000	6,950	5,650	4,000
5	5,000	3,750	10,000	8,660	7,070	5,000
6	6,000	4,500	12,000	10,400	8,500	6,000
7	7,000	5,250	14,000	12,100	9,900	7,000
8	8,000	6,000	16,000	13,850	11,300	8,000
9	9,000	6,750	18,000	15,600	12,700	9,000
10	10,000	7,500	20,000	17,350	14,100	10,000
11	11,000	8,250	22,000	19,100	15,500	11,000
12	12,000	9,000	24,000	20,800	17,000	12,000
				If used with Choker Hitch multiply above values by 3/4. 		
				For Double Basket Hitch multiply above values by 2.  LF90-0217		

Note: For Safe Working Loads of Endless or Grommet Slings, Multiply Above Values by 2.

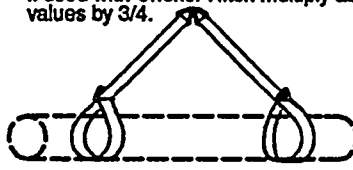
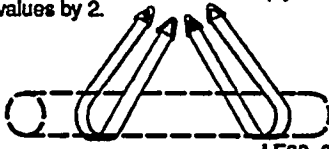

DEPARTMENT OF ENERGY HOISTING & RIGGING MANUAL	TITLE: WIRE ROPE, SLINGS, AND RIGGING ACCESSORIES	REV: 00/91
	NUMBER: 8.0	

Table 8-19.

NYLON WEB SLINGS (8000 lb/in Material)						
Web Width (in.)	Maximum Safe Working Loads—lb (safety factor = 5) (eye & eye, twisted eye, triangle fittings, choker fittings)					
	Single Vertical Hitch	Single Choker Hitch	Single Basket Hitch (Vertical Legs)	2-Leg Bridle Hitch & Single Basket Hitch With Legs Inclined		
					60°	45°
1	1,200	900	2,400	2,080	1,700	1,200
2	2,400	1,800	4,800	4,160	3,400	2,400
3	3,600	2,700	7,200	6,240	5,100	3,600
4	4,800	3,600	9,600	8,300	6,800	4,800
5	6,000	4,500	12,000	10,400	8,500	6,000
6	7,200	5,400	14,400	12,500	10,200	7,200
7	8,400	6,300	16,800	14,550	11,900	8,400
8	9,600	7,200	19,200	16,600	13,600	9,600
9	10,800	8,100	21,600	18,700	15,300	10,800
10	12,000	9,000	24,000	20,800	17,000	12,000
11	13,200	9,900	26,400	22,900	18,650	13,200
12	14,400	10,800	28,800	25,000	20,400	14,400
				<p>If used with Choker Hitch multiply above values by 3/4.</p>  <p>For Double Basket Hitch multiply above values by 2.</p>  <p>LF90-0217</p>		
Note: For Safe Working Loads of Endless or Grommet Slings, Multiply Above Values by 2.						

DEPARTMENT OF ENERGY HOISTING & RIGGING MANUAL	TITLE: WIRE ROPE, SLINGS, AND RIGGING ACCESSORIES	REV: 00/91
	NUMBER: 8.0	

Table 8-20. Rated capacity of nylon web slings (8000 lb/in.)

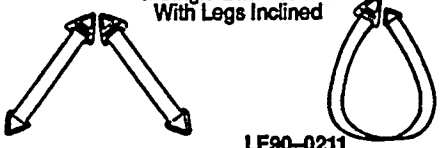
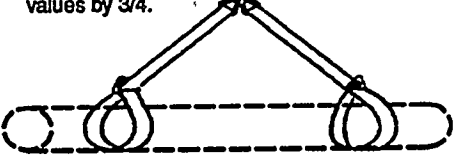
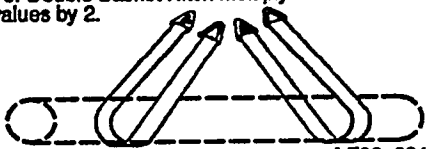
NYLON WEB SLINGS (8000 lb/in Material)						
Web Width (in.)	Maximum Safe Working Loads—lb (safety factor = 5) (eye & eye, twisted eye, triangle fittings, choker fittings)					
	Single Vertical Hitch	Single Choker Hitch	Single Basket Hitch (Vertical Legs)	2-Leg Bridle Hitch & Single Basket Hitch With Legs Inclined		
					60°	45°
1	1,600	1,200	3,200	2,770	2,260	1,600
2	3,200	2,400	6,400	5,550	4,520	3,200
3	4,800	3,600	9,600	8,300	6,800	4,800
4	6,400	4,800	12,800	11,100	9,050	6,400
5	8,000	6,000	16,000	13,850	11,300	8,000
6	9,600	7,200	19,200	16,600	13,600	9,600
7	11,200	8,400	22,400	19,400	15,800	11,200
8	12,800	9,600	25,600	22,200	18,100	12,800
9	14,400	10,800	28,800	25,000	20,400	14,400
10	16,000	12,000	32,000	27,700	22,600	16,000
11	17,600	13,200	35,200	30,500	24,900	17,600
12	19,200	14,400	38,400	33,300	27,200	19,200
				If used with Choker Hitch multiply above values by 3/4.		
						
				For Double Basket Hitch multiply above values by 2.		
						
LF90-0217						

Note: For Safe Working Loads of Endless or Grommet Slings, Multiply Above Values by 2.

DEPARTMENT OF ENERGY HOISTING & RIGGING MANUAL	TITLE: WIRE ROPE, SLINGS, AND RIGGING ACCESSORIES NUMBER: 8.0 REV: 00/91
---	--

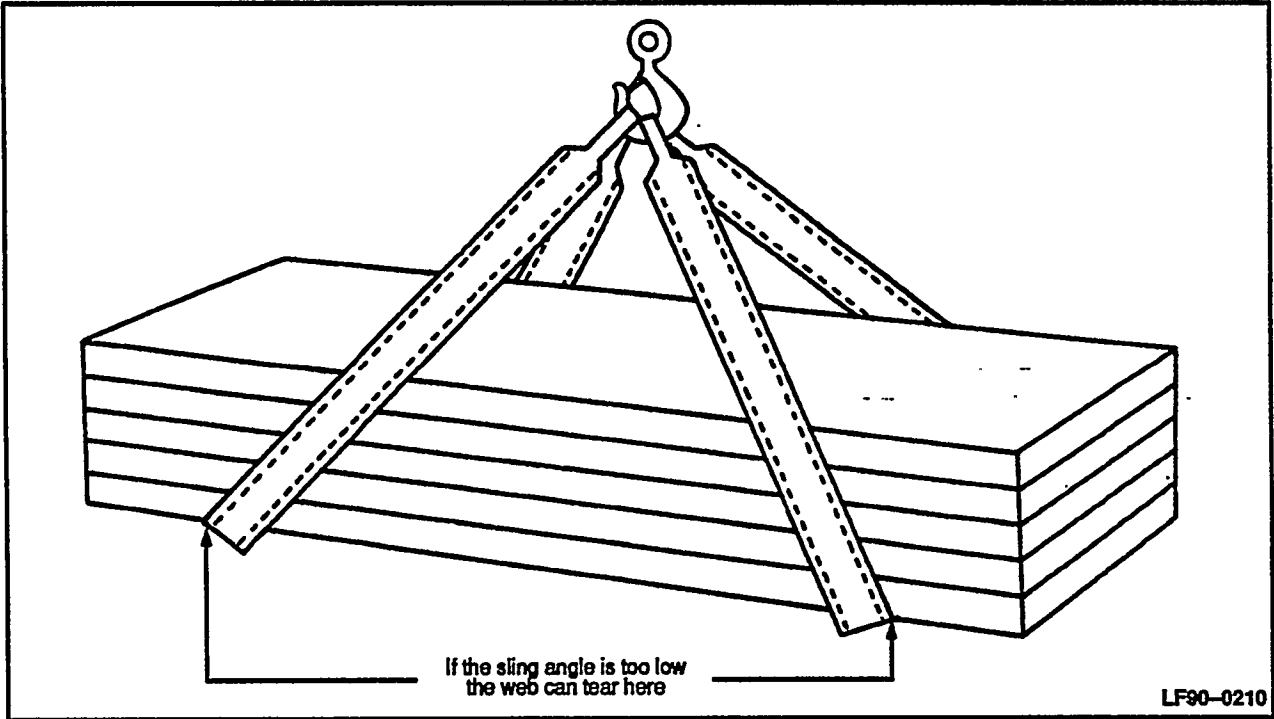

Figure 8-22. Effect of low sling angle on webbing.

(3) Special-High-Consequence Lifts

- (a) All provisions of 8.3.9.t(2) shall apply.

Slings in regular use shall be inspected at least once each month in accordance with the standards in 8.3.9.t(1)(c).

u. Testing

All provisions of 8.3.6.e shall apply.

v. Operating Practices

(1) Ordinary Lifts

- (a) Determine the weight of the load.
- (b) Select a sling having suitable characteristics for the type of load, hitch, and environment.
- (c) Do not load slings in excess of the special rated capacity.
- (d) Slings with fittings which are used in a choker hitch shall be of sufficient length to assure that the choking action is on the webbing.
- (e) Balance the load in slings used in a basket hitch to prevent slippage.
- (f) Do not drag slings on the floor or over any abrasive surface.
- (g) Do not twist or tie slings into knots.
- (h) Protect slings from being cut by sharp corners, sharp edges, and highly abrasive surfaces.
- (i) Do not pull slings from under loads when a load is resting on a sling.
- (j) Do not drop slings.
- (k) Synthetic-mesh slings shall be marked or coded to show:
 - (i) Name or trademark of manufacturer
 - (ii) Serial number
 - (iii) Through this serial number, the special-rated capacity (at specified angle with the horizontal), rated capacity in vertical, basket, and choker hitch, and the load-test date shall be readily available to the user of the sling.
 - (iv) Additional information, such as shop location, size, and length can also be made available.

(2) High-Consequence Lifts

DEPARTMENT OF ENERGY HOISTING & RIGGING MANUAL	TITLE: WIRE ROPE, SLINGS, AND RIGGING ACCESSORIES	REV: 00/91
	NUMBER: 8.0	

- (a) All provisions of 8.3.9.V(1) shall apply.
 - (b) Do not exceed special-rated capacity.
 - (c) Rigging diagrams may be required on a case basis.
 - (d) Slings used in High-Consequence Lifts, as a minimum, shall be marked as in (k) above. As determined on a case basis, the reach, type, and weight of the sling assembly may also be required.
- (3) Special-High-Consequence Lifts
- (a) All provisions of 8.3.9.V(2) shall apply.
 - (b) Rigging diagrams are mandatory.
 - (c) A written history of each use is mandatory. The records required for Special-High-Consequence Lifts are considered adequate to satisfy this requirement.
 - (d) Segregated storage is mandatory.
 - (e) In addition to the requirements of (k) above, slings shall also be identified by reach and weight of sling assembly.

8.4 RIGGING HOOKS:

8.4.1 Design

Hook design shall meet generally accepted hook design standards and be compatible with the requirements of ANSI/ASME B30.10, Chapter 10-2, "Hook - Miscellaneous." (See Section 7.0, "Hooks" for hand hook requirements).

8.4.2 Marking

The manufacturer's identification should be forged, cast, or die stamped on low-stress and non-wearing area of the hook.

8.4.3 Construction

- a. The hook material shall have sufficient ductility to permanently deform before failure at the temperature at which the hook will be used.
- b. Special-rated capacities for hooks shall be equal to or exceed the special-rated capacity of the chain, wire rope, or other suspension members to which they are attached.

8.4.4 Load Limits

A hook shall not be loaded beyond its special-rated capacity, except as is necessary to conform to the requirements for load testing of the sling or hardware to which it is attached. See Table 8-21 for hook capacity.

**DEPARTMENT OF
ENERGY
HOISTING & RIGGING
MANUAL****TITLE: WIRE ROPE, SLINGS, AND RIGGING
ACCESSORIES****NUMBER: 8.0****REV: 00/91****8.4.5 Inspections****a. Ordinary Lifts**

- (1) Visual inspection – every three months by a qualified inspector.
- (2) NDE in accordance with applicable ASTM standards annually. If the NDE has not been completed by the end of the required period, hooks shall be downrated as follows:
 - (a) Thirty calendar days after the end of the period, the equipment shall be downrated to 75% of the rated capacity.
 - (b) Sixty calendar days after the end of the period, the equipment shall be downrated to 50% if the rated capacity.
 - (c) Ninety calendar days after the end of the period, the equipment shall be taken out of service until the required NDE has been completed.
- (3) Hooks having any of the following deficiencies shall be removed from service, unless a qualified person approves their continued limit use:
 - (a) Crack(s)
 - (b) Wear exceeding 10% of the original dimension.
 - (c) A bend or twist exceeding 10 degrees from the plane of the unbent hook
 - (d) Increase in throat opening exceeding 15% from the new condition
 - (e) If a latch is provided, and it becomes inoperative because of wear or deformation, or fails to fully bridge the throat opening, the hook shall be removed from service until the device has been repaired or replaced; or the throat opening has been assessed per (d) above.
 - (f) If hooks are painted, a visual inspection should take the coating into consideration. Surface variations can disclose evidence of heavy or severe service. The surface condition may then call for stripping the paint in such instances.
 - (g) Reports of all inspections shall be maintained. Records should include item identification, characteristics inspected, observations, disposition if any, and date of actions. Records shall be kept readily available for inspection by designated personnel.
- (4) Refer to Exhibit IV "Rigging, Tackle, Accessories, Load Test & Inspection (Hooks, Shackles, Rings, etc.)" which appears at the end of this Section.

b. High-Consequence Lifts

- (1) All provisions of 8.4.5.2.a shall apply.

DRAFT

DEPARTMENT OF ENERGY HOISTING & RIGGING MANUAL	TITLE: WIRE ROPE, SLINGS, AND RIGGING ACCESSORIES	REV: 00/91
	NUMBER: 8.0	

Table 8-21. Strength of standard sling hooks

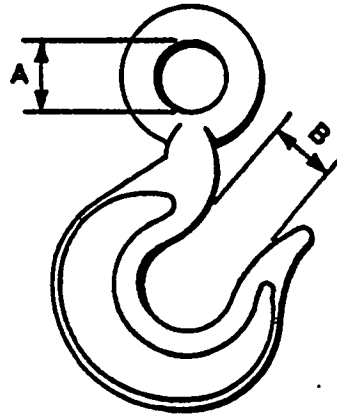

LF90-0226

Standard Hook Number	Inside Diameter of Eye A (in.)	Throat Opening B (in.)	Rated Capacity (tons)
22	3/4	1	0.5
23	7/8	1 1/16	0.6
24	1	1 1/8	0.7
25	1 1/8	1 1/4	1.2
26	1 1/4	1 3/8	1.7
27	1 3/8	1 1/2	2.1
28	1 1/2	1 3/4	2.5
29	1 5/8	1 7/8	3.0
30	1 3/4	2 1/16	4.0
31	2	2 1/4	4.7
32	2 3/8	2 1/2	5.5
33	2 3/4	3	6.8
34	3 1/8	3 3/8	8.0
34 ^a	3 1/4	3 5/8	10.0
35	3 1/2	4	11.0
36	4	4 1/2	20.0
38	4 1/2	5	30.0

Notes:

- The above values are for "Vulcan" and similarly designed standard hooks.
- The capacity can be found by the diameter of the hole in the eye of the hook. If the throat opening of any hook exceeds the dimension given above the corresponding diameter of the eye, the hook has been overstrained and must not be used.

DRAFT

DEPARTMENT OF ENERGY HOISTING & RIGGING MANUAL	TITLE: WIRE ROPE, SLINGS, AND RIGGING ACCESSORIES
	NUMBER: 8.0 REV: 00/91

- c. Special-High-Consequence Lifts
 - (1) All provisions of 8.4.5.b shall apply.
 - (2) Visual inspections shall be conducted monthly.

8.4.6 Testing

- a. Hooks not attached to slings or other lifting hardware shall be proof tested to 200% of the manufacturer's load rating prior to initial use. The test load shall be accurate to within -5%, +0% of stipulated values.
- b. No performance testing of hooks shall be required, except as is necessary to conform to the requirements for the slings or rigging hardware of which they are a part.

8.4.7 Maintenance

- a. Repair of cracks, nicks, and gauges shall be carried out by a designated person by grinding longitudinally, following the contour of the hook, provided that no dimension is reduced more than 10% (or as recommended by the manufacturer) of its original value.
- b. All other repairs shall be performed by the manufacturer or other qualified person.

8.4.8 Operating Practices

- a. Determine that the load or force required does not exceed the rated capacity of the hooks assembly, especially when special conditions, such as choking or grabbing are considered.
- b. Shock loading shall be avoided.
- c. Hands, fingers and body shall be kept from between the hook and the load.

8.5 RIGGING ACCESSORIES:

8.5.1 Shackles

- a. Shackles are made of drop-forged steel and bent into shape. They are strong, closed attachments which will not come unhooked. The size is specified by the diameter of the body. Side pulls on the shackle body should be avoided.
- b. Shackle pins should fit free without binding. A bolt shall never be substituted for the shackle pin. Common bolts are weaker than the pins. (Figure 8-23)
- c. Safe loads on larger size shackles are stamped on the shackle body. The safe load of anchor or chain shackles, screw pin, or slip pin is the same. (Table 8-22)
- d. When shackles are used at load angles other than 90-degrees, reduce the safe-load rating accordingly.

<p>DEPARTMENT OF ENERGY HOISTING & RIGGING MANUAL</p>	<p>TITLE: WIRE ROPE, SLINGS, AND RIGGING ACCESSORIES</p>	<p>REV: 00/91</p>
	<p>NUMBER: 8.0</p>	

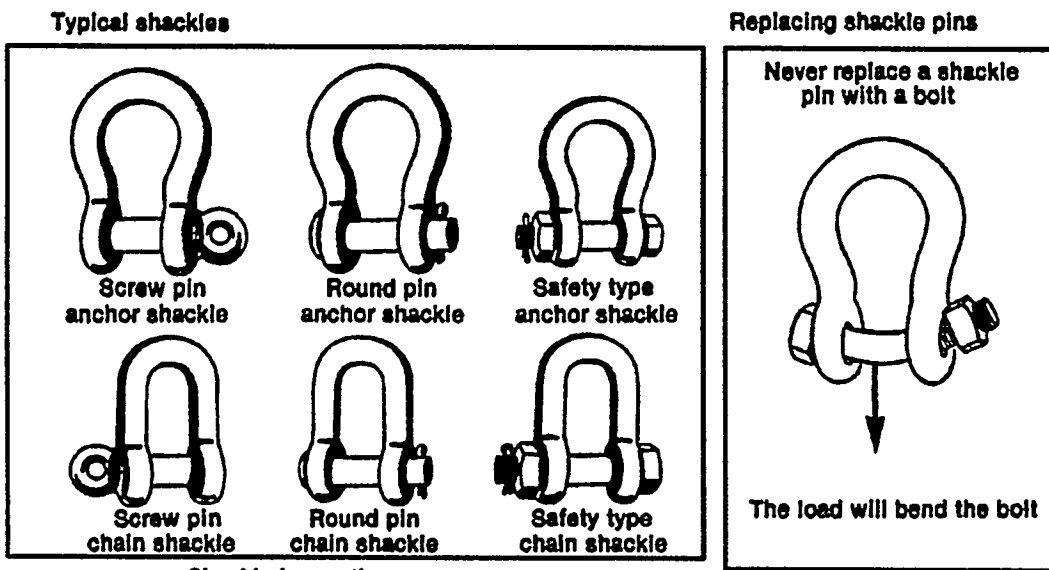

Shackle inspection areas

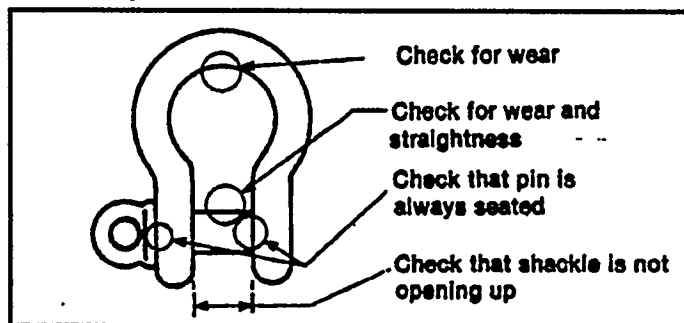

Eccentric shackle loads

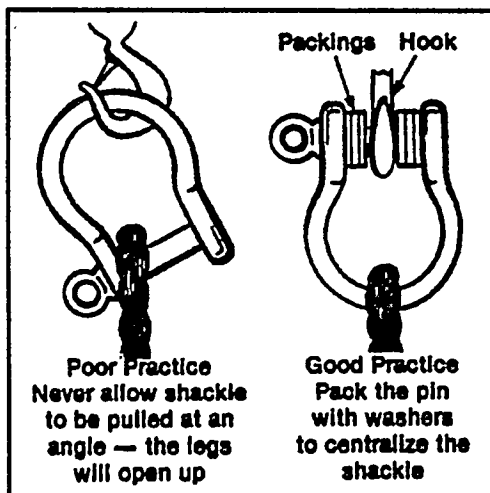

Do not use screw pin shackles if the pin can roll under load and unscrew

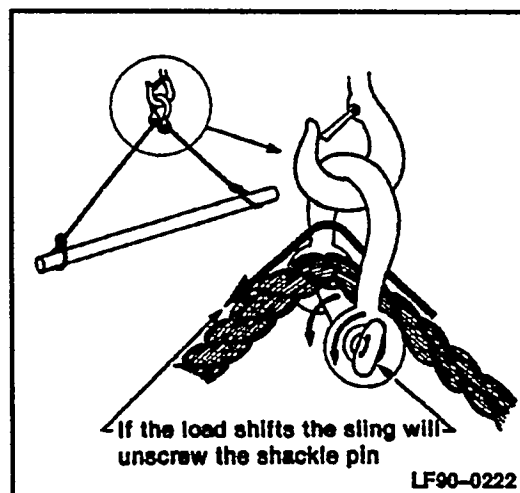

Figure 8-23. Shackles.

**DEPARTMENT OF
ENERGY
HOISTING & RIGGING
MANUAL**

**TITLE: WIRE ROPE, SLINGS, AND RIGGING
ACCESSORIES**

NUMBER: 8.0

REV: 00/91

Table 8-22. Strength of shackles

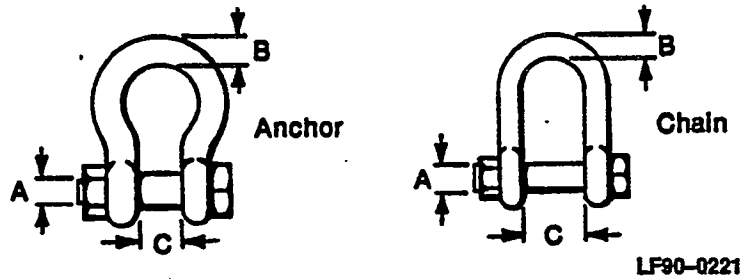

Shackles (all types)		
<ul style="list-style-type: none"> • Weldless construction • Forged alloy steel 		
Stock diameter (in.)	Inside width at pin (in.)	Max. safe working load single vertical pull (lb)
3/16	3/8	665
1/4	15/32	1,000
5/16	17/32	1,500
3/8	21/32	2,000
7/16	23/32	3,000
1/2	13/16	4,000
5/8	1 1/16	6,500
3/4	1 1/4	9,500
7/8	1 7/16	13,000
1	1 11/16	17,000
1 1/8	1 13/16	19,000
1 1/4	2 1/32	24,000
1 3/8	2 1/4	27,000
1 1/2	2 3/8	34,000
1 3/4	2 7/8	50,000
2	3 1/4	70,000
2 1/2	4 1/8	100,000
3	5	150,000
3 1/2	5 3/4	200,000
4	6 1/2	260,000

Notes:

- a. Size of shackles to be identified by diameter of bow.
- b. All shackle pins must be straight.
- c. If the width between eyes exceeds maximum given above, the safe load given must be materially reduced.

DRAFT

8.5.2 Eyebolts

- a. Eyebolts used for hoisting shall be fabricated from forged carbon or alloy steel and shall meet the requirements of ASTM Specification A489, "Carbon Steel Eyebolts."
- b. Eyebolts shall have a minimum safety factor of five and the vertical safe-working load and serial number shall be forged, stamped, or inscribed into each eyebolt by the manufacturer or the owner. A metal tag permanently attached bearing the same information may also be used.
- c. Where an eyebolt is identified as a part of a single-purpose lifting system, the serial number of the lifting system shall also appear on the eyebolt identification.
- d. Eyebolts shall have Class II fit and have a minimum of one-and-one-half diameters thread engagement. Nuts on through-eyebolts shall be secured with lock wires or shall be self-locking types.
- e. Shouldered eyebolts shall be used for all applications, except where it is not possible due to the configuration of the item to be lifted. When unshouldered eyebolts are used, nuts, washers, and drilled plates shall not be used to make shouldered eyebolts.
- f. Wire-type and for welded eyebolts shall not be used in DOE-lifting operations. (Figure 8-23).
- g. Shoulders shall seat snugly against the surface on which it bears.

Spacers may be used, if necessary, to ensure proper seating of the eyebolt. Use a flat spacer no thicker than one-sixteenth the outside diameter and approximately the same diameter as the maximum axis of the eyebolt shoulder, with the smallest inside diameter that will fit the eyebolt shank.

- h. Spot-face or slightly counterbore the surface of the item to which the eyebolt is fastened to the minimum depth needed for cleanup of the surface and complete bearing of the shoulder or spacer on the bearing surface.
- i. Careful inspection of each eyebolt before use is mandatory. The hole shall be visually inspected to assure that there has been no deformation. The condition of the threads in the hole shall be checked to ensure the eyebolt will secure and the shoulder can be brought down snug. Eyebolts which are cracked, bent, or have damaged threads, shall be destroyed (Figure 8-24)

DEPARTMENT OF ENERGY HOISTING & RIGGING MANUAL	TITLE: WIRE ROPE, SLINGS, AND RIGGING ACCESSORIES	REV: 00/91
	NUMBER: 8.0	

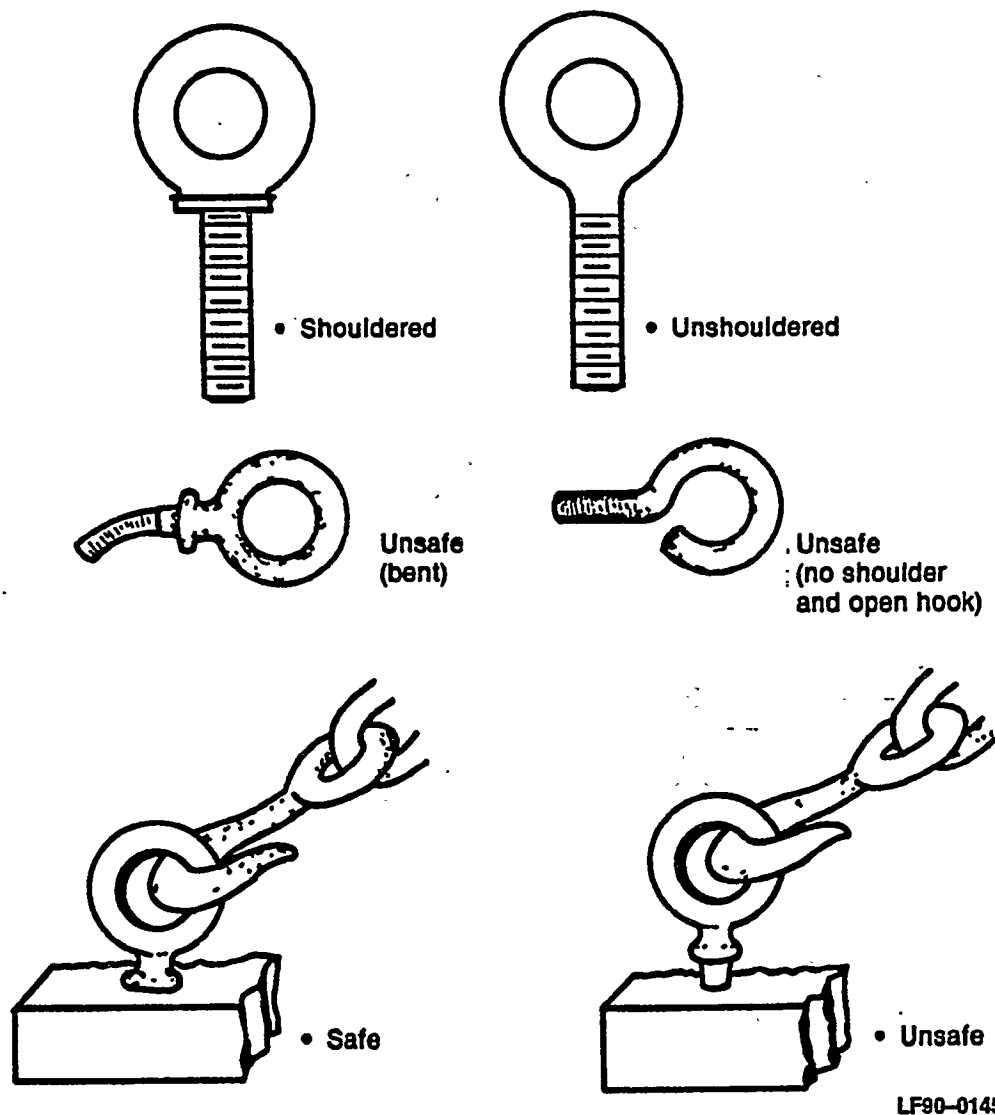

Figure 8-24. Eyebolts.

- j. The shank of the eyebolt shall not be undercut, and shall be smoothly radiused into the plane of the shoulder (or the contour of the ring for nonshouldered eyebolts).
- k. It is recommended that when more than one eyebolt is used in conjunction with multiple-leg rigging, spreader bars, lifting yokes, or lifting beams be utilized to eliminate angular lifting. However, where spreaders, yokes, or beams cannot be utilized, eyebolts may be used for angular lifting, providing the limiting conditions in Table 8-22 are considered. An angular lift is any lift in which the lifting force is applied at any angle to the centerline of the shank of the eyebolt.

DEPARTMENT OF ENERGY HOISTING & RIGGING MANUAL	TITLE: WIRE ROPE, SLINGS, AND RIGGING ACCESSORIES	REV: 00/91
	NUMBER: 8.0	

1. Where nonshouldered eyebolts must be used for a high-consequence/special-high-consequence lifts, an engineering analysis of the loading and load vectors shall be made and approved before use. The angle between the sling and the eyebolt axis shall be minimized. In no case shall the eyebolt loading exceed the value found in Table 8-23.

Table 8-23. Safe loading of eyebolts

Stock Diameter (in.)	SAFE WORKING LOADS (LBS) CORRESPONDING TO ANGLE OF PULL				
	Vertical	75°	60°	45°	Less than 45°
1/4	500	Reduce Vertical Loads By 45%	Reduce Vertical Loads By 65%	Reduce Vertical Loads By 75%	NOT RECOMMENDED
5/16	800				
3/8	1,200				
1/2	2,200				
5/8	3,500				
3/4	5,200				
7/8	7,200				
1	10,000				
1 1/4	15,200				
1 1/2	21,400				

EYE BOLTS
 — Shoulder Type Only
 — Forged Carbon Steel

LF90-0223

Note: S.W.L. for plain (shoulderless) eye bolts are same as for shoulder bolts under vertical load. Angular loading is not recommended.

8.5.3 Turnbuckles

- a. Turnbuckles may be used in sling systems provided they are engineered, designed, and approved as a part of the sling system. Approved turnbuckles shall be marked and identified for use with the sling set for which it was designed, and shall be load tested as part of the sling set. Turnbuckles shall be inspected before each use for damage. Damaged threads, jamb nuts, or bent frame members shall disqualify the unit for use. Jamb nuts or locking devices must be tightened or locked before making lifts with turnbuckles. (Figure 8-25)

DEPARTMENT OF ENERGY HOISTING & RIGGING MANUAL	TITLE: WIRE ROPE, SLINGS, AND RIGGING ACCESSORIES NUMBER: 8.0 REV: 00/91
---	---

Turnbuckle Inspection Areas

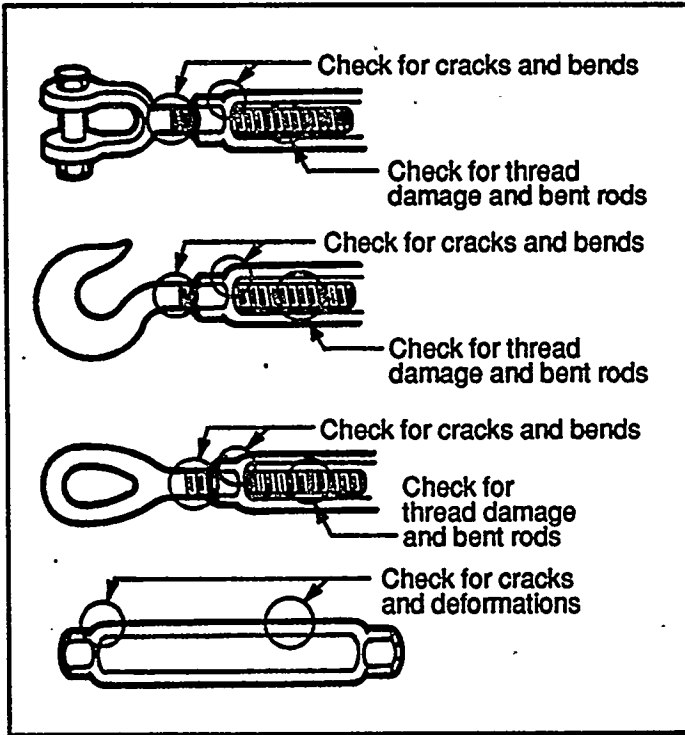

TURNBUCKLES

	<ul style="list-style-type: none"> • Weldless Construction • Forged Alloy Steel 	
End fitting, stock diameter (in.)	SWL of any combination of jaw end fittings, eye and fittings and stub end fittings (lb)	SWL of Any turnbuckle having a hook end fitting (lb)
1/4	500	400
5/16	800	700
3/8	1,200	1,000
1/2	2,200	1,500
5/8	3,500	2,250
3/4	5,200	3,000
7/8	7,200	4,000
1	10,000	5,000
1 1/4	15,200	5,000
1 1/2	21,400	7,500
1 3/4	28,000	—
3	37,000	—
2 1/2	60,000	—
2 3/4	75,000	—

Turnbuckles

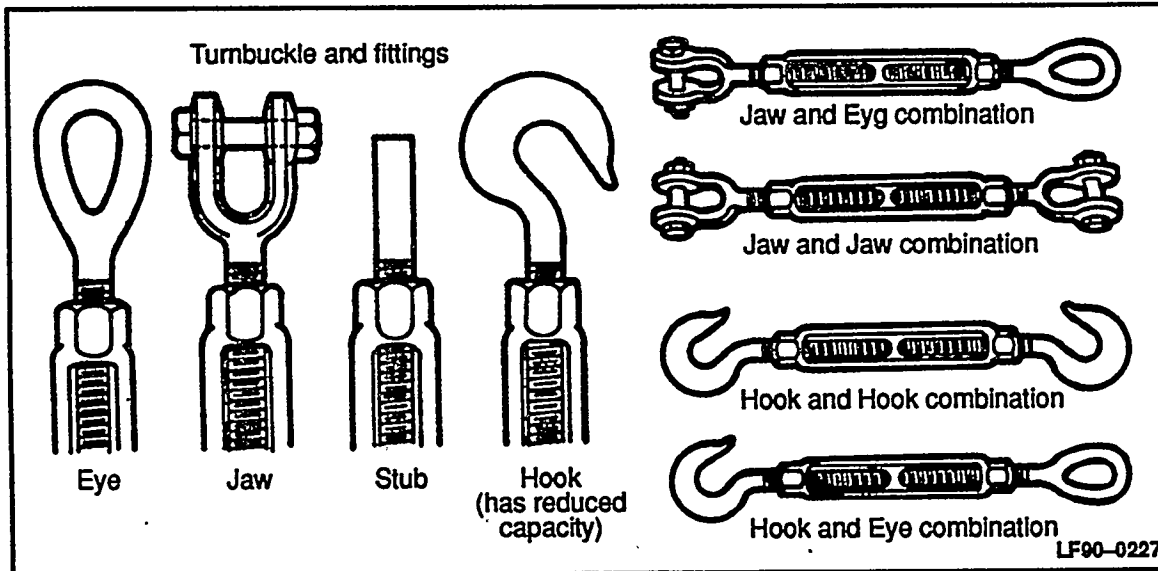
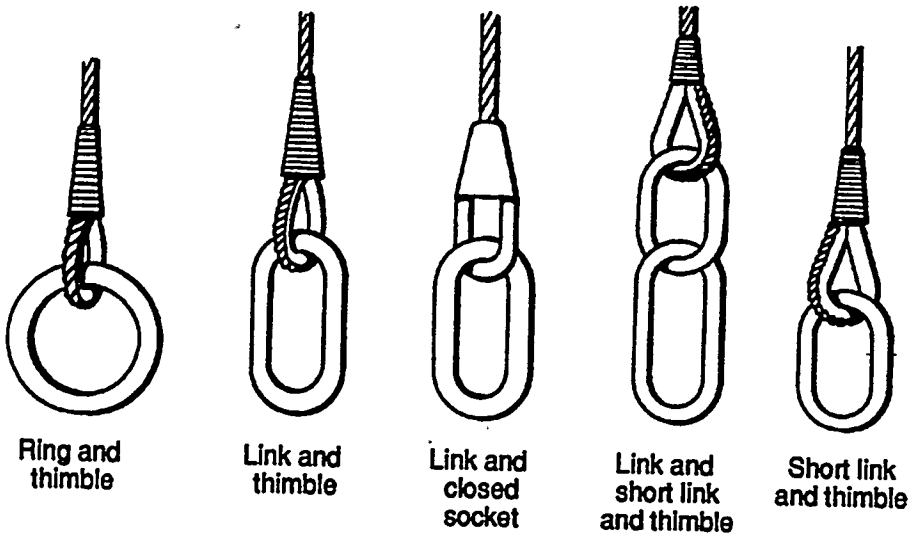

Figure 8-25. Turnbuckles.

- b. Turnbuckles shall be fabricated from forged, alloy steel and shall have a minimum safety factor of 5:1.
- c. Turnbuckles used in applications where vibration is present shall be secured to the frame with locks, pins or wires to prevent turning or loosening.

8.5.4 Links and Rings

Links and Rings are usually designed and manufactured as a part of the lifting hardware for a specific purpose, such as the peak link on multiple-leg slings. However, the rings and links may also be found on the load-attachment end of slings.



LF90-1043

Figure 8-26. Rings and Links.

DEPARTMENT OF ENERGY HOISTING & RIGGING MANUAL	TITLE: WIRE ROPE, SLINGS, AND RIGGING ACCESSORIES	REV: 00/91
	NUMBER: 8.0	

Table 8-24. Safe loads for weldless rings and links

RINGS



Dimensions		Est. wt. each (lb)	Safe load single pull (lb)
Stock diam. (in.)	Inside diam. (in.)		
7/8	4	2 3/4	7,200
7/8	5 1/2	3 1/2	5,600
1	4	3 5/8	10,800
1 1/8	6	6 1/2	10,400
1 1/4	5	7	17,000
1 3/8	6	10	19,000

SLING LINKS

Diam. stock (in.)	Length inside (in.)	Inside width small end	Inside width large end	Est. wt. per 100 (lb)	Safe load single pull (lb)
3/8	2 1/2	3/8	1 1/4	23	1,800
1/2	3	1/2	1 5/8	50	3,200
*5/8	3 3/4	1 1/4	2 1/2	110	4,200
*3/4	4 1/2	1 1/2	3	190	6,000
*7/8	5 1/4	1 3/4	3 1/2	285	8,300
*1	6	2	4	430	10,800
1 1/4	6	1 1/4	3 3/4	700	22,000
*1 3/8	8 1/4	2 3/4	5 1/2	1125	20,500

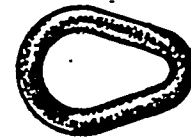

*Sizes of sling links denoted by the asterisk are new and have the larger inside dimensions needed for 2-leg slings.

END LINKS



LF90-0225

Diam. stock (in.)	Inside length (in.)	Inside width (in.)	Est. wt. per 100 (lb)	Suggested safe loads (lb)
5/16	1 3/4	1/2	14	2,500
3/8	1 7/8	9/16	21	3,800
1/2	2 3/8	3/4	48	6,500
5/8	3 1/4	1	92	9,300
3/4	3 1/2	1 1/8	137	14,000
7/8	5 1/8	2	275	12,000
1	5 1/8	2	360	17,000
1 1/4	6 7/16	2 1/4	700	28,000
1 3/8	7 3/4	2 3/4	1000	30,000

DRAFT

NT OF & RIGGING	TITLE: WIRE ROPE, SLINGS, AND RIGGING ACCESSORIES	REV: 00/91
	NUMBER: 8.0	

Metal-Plate Clamps

- a. Plate clamps are designed specially for lifting metal plates. They may also be used for fiber sheets. Their grip or hold is determined by the weight or pull of the load.
- b. The plate shall be inserted all the way into the clamp to ensure that a good grip is obtained (Figure 8-27).
- c. Plate clamps are suitable for handling only one plate at a time.
- d. Side pulls on plate clamps should be avoided.
- e. Plate clamps shall be checked for wear in the jaws and for loose, worn, or broken parts.
- f. The safe-load capacity of each plate clamp should be stamped on the body.

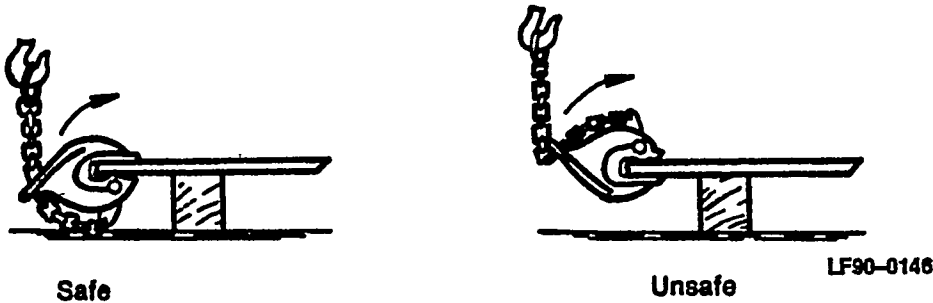

Figure 8-27. Metal-Plate Clamps.

Special Devices

- a. General
 - (1) Where material, equipment, tooling, work in progress, and other devices are by nature irregular, bulky, or hard-to-handle, it is often necessary to provide special hangers, slings, beams, etc., to permit safe and efficient operations.
 - (2) Special devices, which are to be used for High Consequence or Special High Consequence Lifts of 10,000 pounds or more, shall meet the requirements of ANSI N 14.6.
 - (3) Each special device shall be clearly and permanently marked with its capacity and weight.
 - (4) The following procedure shall be used to ensure that such devices of "in-plant" construction are satisfactory:
 - (a) The department needing the device shall request a competent technical design group to design a device which will perform the operation safely.

DRAFT

**DEPARTMENT OF
ENERGY
HOISTING & RIGGING
MANUAL**

**TITLE: WIRE ROPE, SLINGS, AND RIGGING
ACCESSORIES**

NUMBER: 8.0

REV: 00/91

- (b) After the design is completed, a drawing, with strength calculations and construction details, shall be forwarded to the cognizant Safety organization for concurrence.
 - (c) Welded areas shall be assembled and inspected in accordance with AWS D1.1.
 - (d) A qualified person shall be appointed to witness the first test lift and give final approval before the device is released for regular use.
 - (e) Inspection, using accepted nondestructive examination techniques, shall be conducted every 12 months by authorized personnel.
 - (f) Authorized personnel shall be qualified in accordance with ASNT-TC-1A.
- b. **Load-indicating Devices**
- (1) Load-indicating devices are not required in routine operations where loads of known and essentially consistent weight are to be handled. The use of load-indicating devices shall be specified for loads of uncertain weight which could be within 90-100% of the manufacturer's rated capacity of the equipment or maximum working load of any part of the tackle. Load-indicating devices shall be specified where the equipment tackle configuration could result in binding or friction of the load that could cause a greater stress in the hoist or tackle than would result from the apparent hook load.
 - (2) Load-indicating devices shall meet the performance requirements of SAE J376 and shall be designed so that failure of the device cannot result in dropping, upsetting, or losing control of the load. The accuracy, function, and readability of the device shall not be hampered or obstructed by attachments to the device.
 - (3) The accuracy of load-indicating devices shall depend upon the requirements of the load system planned, and shall not restrict the system requirements; an accuracy of $\pm 2\%$ of full-scale reading within the range of 10-70% of instrument range is recommended; the device should be selected so that the estimated hook load lies between 10-70% of the instrument range.
 - (4) Load-indicating devices shall be calibrated at regular intervals using standards traceable to the National Bureau of Standards. All calibrated devices shall have a tag affixed indicating date of calibration, by whom calibrated, and date next calibration is due.
 - (5) Dynamometers commonly have safety factors of less than 5-to-1. Any combination where the safety factor of the dynamometer times the capacity of the dynamometer divided by the load equals 5 is acceptable.
 - (6) When dynamometers are used as load-bearing parts of rigging, they must be constructed to provide a measure of safety and reliability equal to that of the associated rigging, or a safety device must be installed to prevent dropping the load in the event of a failure.
- c. **Magnets, Buckets, Coil Lifters and Similar Devices**

The weight of such devices, when attached, shall be deducted from the rated or special-rated capacity of the crane, when determining the rating for the proposed lift. Such devices shall be

DRAFT

**DEPARTMENT OF
ENERGY
HOISTING & RIGGING
MANUAL**

**TITLE: WIRE ROPE, SLINGS, AND RIGGING
ACCESSORIES**

NUMBER: 8.0

REV: 00/91

placed on the ground or floor when not attended. A special safety latch shall be installed to prevent rotation. The latch shall be in proper position at all times. The device shall not be used if the latch is out of order.

8.5.7 Inspections

a. Periodic Inspections

Tackle in regular use for handling Special-High-Consequence Loads shall be inspected at least once a month by a qualified inspector. Tackle in regular use for handling all other loads shall be inspected by a qualified inspector at least every three months. Tackle not in regular use shall be inspected before use. At least once a year, hooks shall be examined by an NDE method in accordance with the sections of ASTM Standards applicable to the method of examination used. NDE of shackles, links, rings, eyebolts, and other accessories shall be made in accordance with the same standards, when directed by the cognizant line manager or his/her authorized representative. Inspection records shall be kept on file and readily available.

b. Frequent Inspections

- (1) Slings, lifting bars, rigging assemblies, and hooks shall be inspected at the beginning of each shift in which they are to be used, and before the start of any lift of a Special-High-Consequence Load.
- (2) Shackles, rings, and similar items shall be inspected for wear, corrosion, spreading, and deformation, and shall be replaced if deformation exceeds 15% of their new condition. Shackle pins shall be replaced if they show any sign of incipient failure in shear. These requirements are incorporated in Exhibit IV, "Rigging, Tackle, Accessories Load Test and Inspection (Hooks, Shackles, Slings, etc.," which appears at the end of this Section.
- (3) Lifting bars and spreaders shall be inspected for signs of incipient failure in bending, and shall be replaced if permanently bent more than 1/2 inch in 10 feet, or twisted more than 5-degrees out of the original plane. Hook attachment welds shall be examined for cracks and signs of failure in tension. Welds shall be NDE examined in accordance with pertinent sections of applicable ASTM Standards, at least once a year. These requirements are incorporated in Exhibit V, "Lifting Bars and Spreaders Load Test and Inspection," which appears at the end of this Section.

8.5.8 Testing

a. General

- (1) Tackle assemblies, handling fixtures, and rigging accessories shall be tested as a unit when practical. When necessary, individual parts of such assemblies may be tested individually with the approval of the inspector.
- (2) Test loads shall be accurate to within +5%, -0% of stipulated values.
- (3) Test loads shall be arranged so that actual service-load conditions are duplicated to the maximum possible extent, including sling angles, etc.
- (4) All parts showing damage or permanent deformation as a result of load testing shall be replaced. Replacement parts shall be load tested in accordance with this paragraph. Discarded parts shall be destroyed.

DRAFT

**DEPARTMENT OF
ENERGY
HOISTING & RIGGING
MANUAL**

**TITLE: WIRE ROPE, SLINGS, AND RIGGING
ACCESSORIES**

NUMBER: 8.0

REV: 00/91

- (5) Multi-leg lift assemblies that are not statically determinate^a shall be load tested based on any two legs sharing the entire load. Legs not undergoing test shall be attached in a manner to ensure that load stability is not lost during the test.
 - (6) Dynamometers/load cells shall be tested and calibrated at least once a year and when specified in the procedure before making a critical lift. This also applies if they have not been used in the previous six months.
- b. Ordinary Lifts**
- (1) Rigging accessories (except guys, guidelines, or other nonload-bearing items) shall be load tested and inspected annually at 100% of rated capacity by a qualified inspector. Load test records shall be kept on file and readily available.
 - (2) If a test has not been completed by the end of the required period, the equipment shall be downrated as follows:
 - (a) Thirty calendar days after the end of the period, the equipment shall be downrated to 75% of the rated capacity.
 - (b) Sixty calendar days after the end of the period, the equipment shall be downrated to 50% of the rated capacity.
 - (c) Ninety calendar days after the end of the period, the equipment shall be taken out of service until the required inspection has been completed.
- c. High-Consequence Lifts**
- (1) All provisions of 8.5.8.b shall apply.
 - (2) Load tests shall be conducted at least once a year, before making a critical lift (if specified in the procedure), and if they have not been used in the previous six months unless they have been stored in bonded or controlled (locked) storage where protection against the effect of weather or any other type of abuse has been provided. Load test records shall be kept on file and readily available.
 - (3) Load tests shall be at 150% of the maximum static load that will be encountered in service, -15%, +0% of stipulated values.
 - (4) Test loads should be structured by administrative control to 150% of the maximum operational load anticipated in the following 12-month period, rather than routinely at 150% of the rated capacity.
- d. Special-High-Consequence Lifts**
- (1) All provisions of 8.5.8.c shall apply.
 - a. A lift configuration in which one or more members of the assembly must deform, within its elastic limit, in order to balance the load on all legs is not considered to be statically determinate.

8.5.9 Good and Bad Rigging Practices

Figure 8-28 illustrates some good and bad rigging practices.

DRAFT

DEPARTMENT OF ENERGY HOISTING & RIGGING MANUAL	TITLE: WIRE ROPE, SLINGS, AND RIGGING ACCESSORIES
	NUMBER: 8.0 REV: 00/91

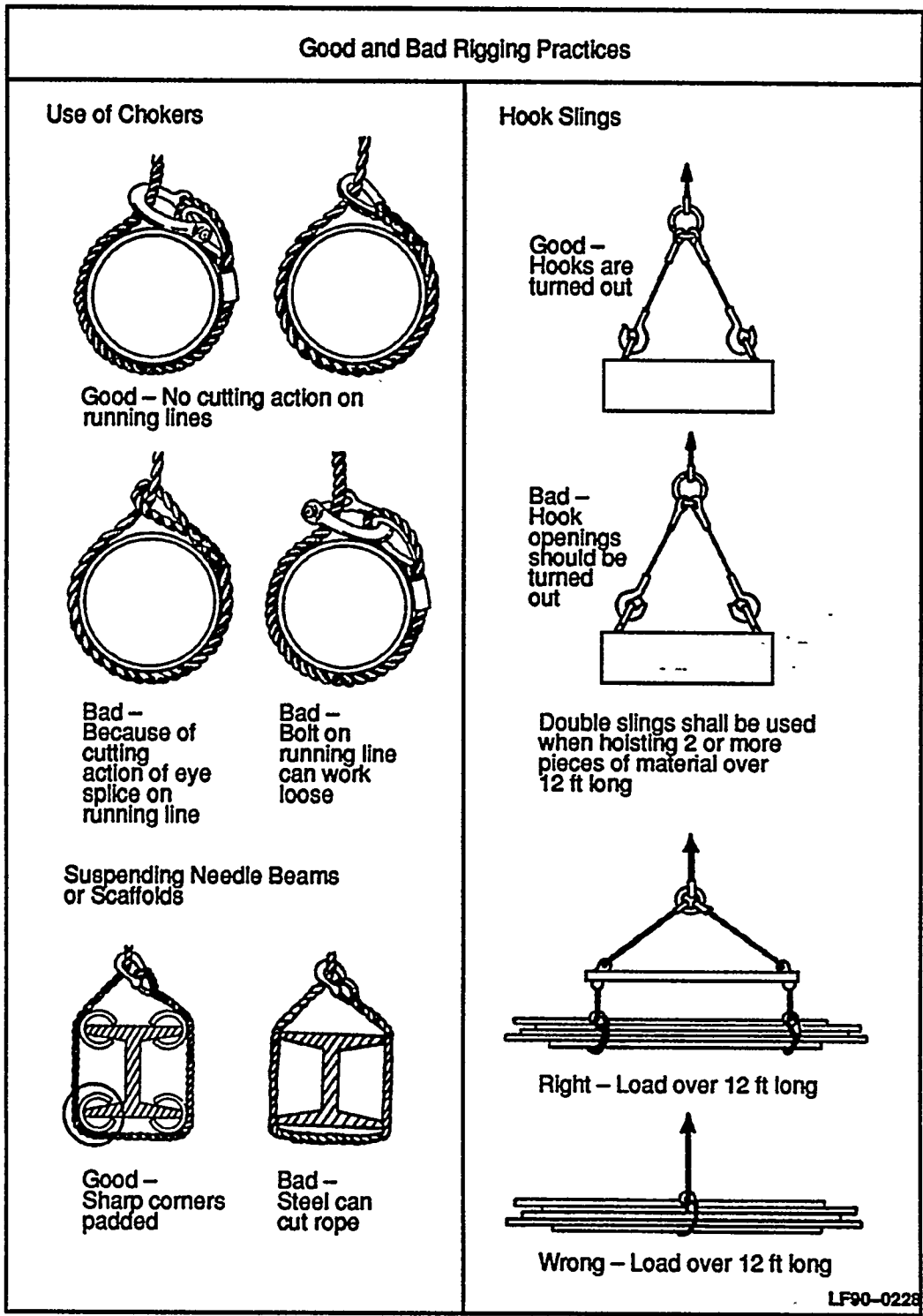

Figure 8-28. Good & bad rigging practices.

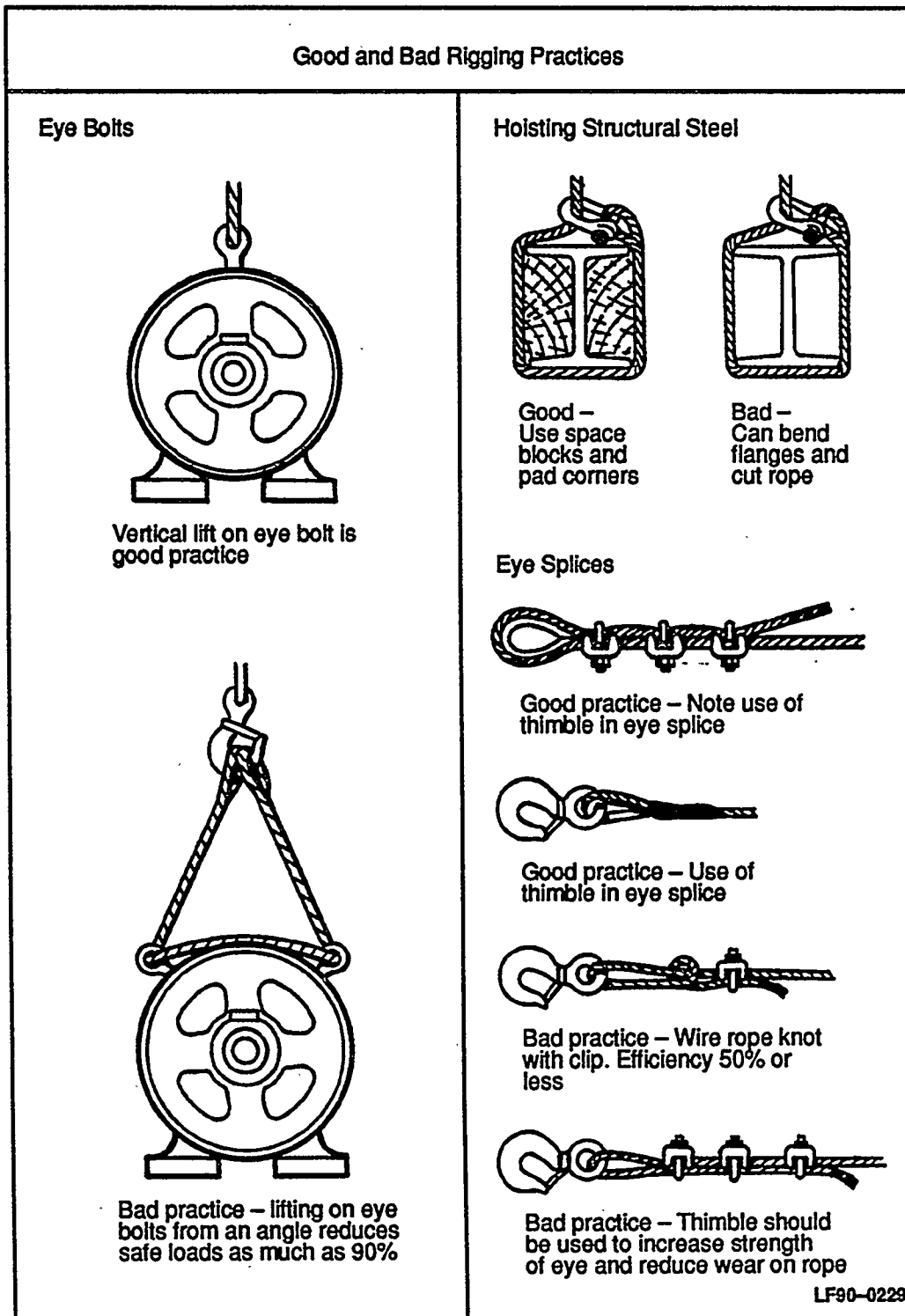

Figure 8-28. (continued)

**DEPARTMENT OF
ENERGY
HOISTING & RIGGING
MANUAL**

**TITLE: WIRE ROPE, SLINGS, AND RIGGING
ACCESSORIES**

NUMBER: 8.0

REV: 00/91

**Exhibits I through V are intended
to be checkoff lists and model forms
only. Any other form that accomplishes
the purpose is acceptable.**

DRAFT

DEPARTMENT OF ENERGY HOISTING & RIGGING MANUAL	TITLE: WIRE ROPE, SLINGS, AND RIGGING ACCESSORIES	REV: 00/91
	NUMBER: 8.0	

EXHIBIT I

**RIGGING TACKLE ANNUAL INSPECTION
(WIRE ROPE)**

Inspector _____ NDE Inspector _____ Date _____

- NOTES:**
1. NDE Inspector shall witness and verify all steps below.
 2. All inspections shall be in accordance with DOE Hoisting and Rigging Manual.
 3. Proof test to 200% of manufacturer's rated capacity to certify new equipment procured without manufacturer's certification. Load test at 100% of manufacturer's rated capacity for equipment used for ordinary service, and at 150% of manufacturer's rated capacity for equipment used for critical lifts. Test loads shall be accurate to within -5%, +0% of the stipulated values.

Wire rope shall be immediately removed from service if any of the following conditions are present:

INSPECTION

1. Six random distributed broken wires in one rope lay or three broken wires in one strand in one rope lay.
2. Wear of 1/3 the original diameter of the outside individual wire
3. Kinking, crushing, or bird caging distorting the wire rope structure
4. Heat damage.
5. Cracked, deformed, or worn end attachments.
6. If hooks are cracked, or opened more than 15% of normal throat opening measured at the narrowest point or twisted more than 10 degrees from the plane of the unbent hook.
7. Corrosion of the rope or end attachments.

Size: (Length, Diameter, Etc.) _____ Capacity (SWL) _____

Actual Load Test _____ lbs

REMARKS _____

NDE Inspector shall inspect hook by visual examination, liquid penetrant examination, or magnetic particle examination.

Acceptance: No cracks, linear indications, laps, or seams.

NDT INSPECTION OF HOOKS/RINGS, ETC. _____

NDE INSPECTOR _____ DATE _____

DEPARTMENT OF ENERGY HOISTING & RIGGING MANUAL	TITLE: WIRE ROPE, SLINGS, AND RIGGING ACCESSORIES
	NUMBER: 8.0
	REV: 00/91

EXHIBIT III

RIGGING TACKLE PERIODIC INSPECTION
(NONMETALLIC SLINGS & ROPES)

INSPECTOR _____ INSPECTION DATE _____

- NOTES:**
1. Proof test to 200% of manufacturer's rated capacity to certify new equipment procured without manufacturer's certification. Load test at 100% of manufacturer's rated capacity for equipment used for ordinary service, and at 150% of manufacturer's rated capacity for equipment used for critical lifts. Test loads shall be accurate to within - 5%, + 0% of the stipulated values.
 2. NDE Inspector shall witness all steps below.
 3. All inspections shall be in accordance with DOE Hoisting and Rigging Manual.

Synthetic web slings shall be immediately removed from service if any of the following conditions are present that would give doubt to the integrity of the sling:

- a. Acid or caustic burns
- b. Melting or charring of any part of the sling surface
- c. Snags, punctures, tears, or cuts
- d. Broken or worn stitches
- e. Distortion of fittings

Natural and synthetic fiber rope slings shall be immediately removed from service if any of the following conditions are present:

- a. Abnormal wear
- b. Powdered fiber between strands
- c. Broken or cut fibers
- d. Variations in the size or roundness of strands
- e. Discoloration or rotting
- f. Distortion of hardware in the sling

TYPE: Web Sling _____ Rope Sling _____

SIZE: (Length, Diameter, Etc.) _____ Capacity (SWL) _____

REMARKS: _____

NDE INSPECTOR _____ DATE _____

**DEPARTMENT OF
ENERGY
HOISTING & RIGGING
MANUAL**

**TITLE: WIRE ROPE, SLINGS, AND RIGGING
ACCESSORIES**

NUMBER: 8.0

REV: 00/91

EXHIBIT IV

Page 1 of 1

RIGGING, TACKLE, ACCESSORIES LOAD TEST AND INSPECTION
(HOOKS, SHACKLES, RINGS, ETC.)

INSPECTOR _____ **INSPECTION DATE** _____

- NOTES:**
1. Proof test to 200% of manufacturer's rated capacity to certify new equipment procured without manufacturer's certification. Load test at 100% of manufacturer's rated capacity for equipment used for ordinary service, and at 150% of manufacturer's rated capacity for equipment used for critical lifts. Test loads shall be accurate to within - 5%, + 0% of the stipulated values.
 2. NDE Inspector shall witness all steps below.
 3. Accept, reject, data should be to manufacturer's specifications. Hooks, shackles, rings, etc., shall be removed from service if any of the following conditions are present that would give doubt to the integrity of the accessories.
 4. Rigging accessories or hooks shall be rejected and discarded if the following conditions are noted.
 - A. Corrosion, damage, or undue wear
 - B. Cracks, twists, or openings
 - (1) 15% more than normal opening
 - (2) 10% twist more than normal from the plane of the hook
 - (3) 10% wear of the throat
 - (4) 5% elongation of the shank
 5. Shackles, Rings, Etc.
 - A. Wear, Corrosion, spreading, and Deformation
 - (1) 15% deformation of their new condition
 - (2) Shackle pins - any sign of incipient failure in shear

Type _____ Size _____ MFG Rated Capacity (SWL) _____

Tested to _____

Serial Numbers _____

NDE Inspector shall perform NDT test by visual examination, liquid penetrant examination, or magnetic particle examination.
Acceptance: No cracks, linear indications, laps, or seams.

NDE INSPECTOR VERIFY _____ DATE _____

DRAFT

**DEPARTMENT OF
ENERGY
HOISTING & RIGGING
MANUAL**

**TITLE: WIRE ROPE, SLINGS, AND RIGGING
ACCESSORIES**

NUMBER: 8.0

REV: 00/91

EXHIBIT II

Page 1 of 2

RIGGING TACKLE ANNUAL INSPECTION
(CHAIN)

INSPECTOR _____ QUALITY _____ INSPECTION DATE _____

- NOTES:**
1. NDE Inspector shall witness and verify all steps below.
 2. All inspections shall be in accordance with DOE Hoisting and Rigging Manual.
 3. Proof test to 200% of manufacturer's rated capacity to certify new equipment procured without manufacturer's certification. Load test at 100% of manufacturer's rated capacity for equipment used for ordinary service, and at 150% of manufacturer's rated capacity for equipment used for critical lifts. Test loads shall be accurate to within -5%, + 0% of the stipulated values.

INSPECTION

- _____ 1. Hand chain in a vertical position, if practical, for preliminary inspection. Chain should hang reasonably straight if links are not distorted.
- _____ 2. Measure accurately the reach (inside of crane ring to inside of hook) under no load when new and at each inspection, and keep a record of increase in length.
- _____ 3. Check for localized stretch and wear, lift each link from its seat and visually inspect for grooving. If grooving is noticed, check stock diameter of links to be within the minimum safe dimension in the table below.
- _____ 4. Sharp transverse nicks should be rounded out by grinding.

Chain slings shall be immediately removed from service if any of the following conditions are present:

- a. Cracked or deformed master links, coupling links, etc.
- b. If hooks are cracked, or opened more than 15% of normal throat opening measured at the narrowest point or twisted more than 10 degrees from the plane of the unbent hook.
- c. If wear at any point of any chain link exceeds that shown in the table.

MAXIMUM ALLOWABLE WEAR AT ANY POINT OF LINK

<u>Chain Size (Inches)</u>	<u>Max Allowed</u>	<u>Chain Size (Inches)</u>	<u>Max Allowed</u>
1/4	3/64	1	3/16
3/8	5/64	1 1/8	7/32
1/2	7/64	1 1/4	1/4
5/8	9/64	1 3/8	9/32
3/4	5/32	1 1/2	5/16
7/8	11/64	1 3/4	11/32

DRAFT

DEPARTMENT OF ENERGY HOISTING & RIGGING MANUAL	TITLE: WIRE ROPE, SLINGS, AND RIGGING ACCESSORIES NUMBER: 8.0 REV: 00/91
---	---

EXHIBIT II (continued)

RIGGING TACKLE ANNUAL INSPECTION
(CHAIN)

Size & Length _____ Actual Load Test _____ Capacity (SWL) _____

Remarks _____

NDE Inspector shall inspect hook by visual examination, liquid penetrant examination, or mag. particle examination.

NDT Inspection of Hooks/Rings, Etc. _____

NDE INSPECTOR _____ DATE _____

DEPARTMENT OF ENERGY HOISTING & RIGGING MANUAL	TITLE: WIRE ROPE, SLINGS, AND RIGGING ACCESSORIES	REV: 00/91
	NUMBER: 8.0	

EXHIBIT V

LIFTING BARS AND SPREADERS LOAD TEST AND INSPECTION
DATE INSPECTOR

INSPECTOR _____ **INSPECTION DATE** _____
[REDACTED]

- NOTES:**
1. Load test at 100% of manufacturer's rated capacity for equipment used for ordinary lifts, and at 150% of maximum anticipated static load up to 150% of manufacturer's rated capacity for equipment used for critical lifts. The test load shall be accurate to within -5%, +0% of stipulated values.
 2. NDE Inspector shall witness all steps below.

INSPECTION

Lifting bars and spreaders shall be checked for signs of incipient failure in bending and shall be replaced if permanently bent more than 1/2 inch in 10 feet or twisted more than 5 degrees out of the original plane. Hook attachment welds shall be examined for cracks and signs of failure in tension.

NDE Inspector shall perform test by visual examination, liquid penetrant examination, or mag. particle examination. Acceptance: No cracks, linear indication, laps, or seams.

STATIC TEST – Hold weight for 10 minutes and visually inspect for deformation.

Type _____ **Size** _____
MFG Rated Capacity (SWL) _____ **lbs.** **Actual Load Test** _____ **lbs.**
Serial Number _____

NDE Inspector Verify (Load Test) _____ **Date** _____

Remarks _____

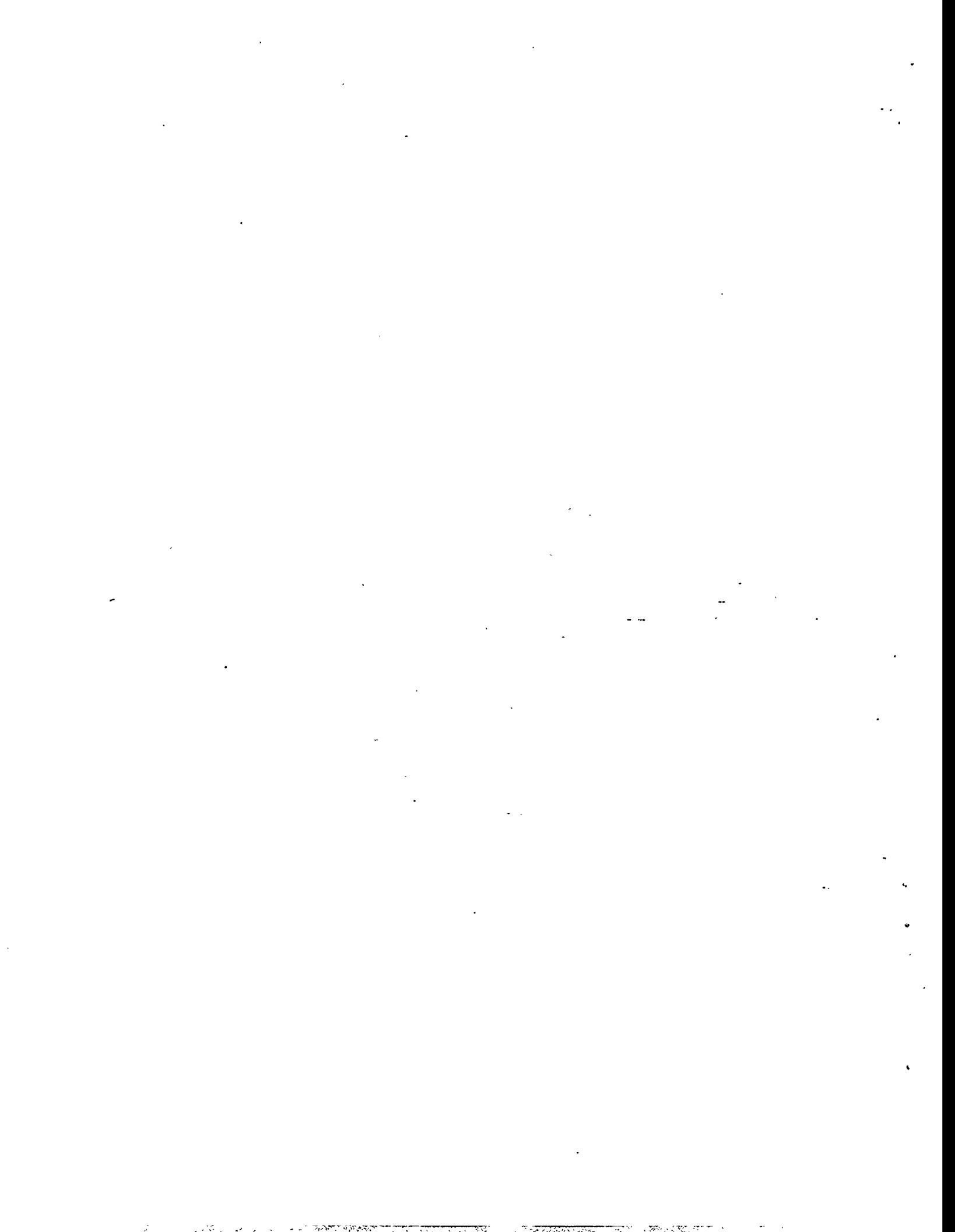

**DEPARTMENT OF
ENERGY
HOISTING & RIGGING
MANUAL**

**TITLE: CONSTRUCTION HOISTING AND RIGGING
EQUIPMENT REQUIREMENTS**

NUMBER: 9.0

REV: 00/91

ISSUE NO. 4

CONTENTS

9.1	Introduction	9-1
9.2	Definitions	9-1
9.3	Personnel Qualifications	9-7
9.3.1	Qualified Operators	9-7
9.3.2	Qualified Riggers	9-8
9.3.3	Person-in-Charge	9-8
9.4	Inspection and Testing	9-8
9.4.1	General	9-8
9.4.2	Mobile Cranes/Boom Trucks – Inspection	9-9
9.4.3	Mobile Cranes/Boom Trucks – Testing	9-13
9.4.4	Forklift Trucks – Inspection	9-14
9.4.5	Forklift Trucks – Testing	9-14
9.4.6	Slings – Inspection	9-15
9.4.7	Slings – Testing	9-17
9.4.8	Rigging Accessories – Inspection	9-18
9.4.9	Rigging Accessories – Testing	9-19
9.5	Operating Practices	9-20
9.5.1	General	9-20
9.5.2	Lifting Personnel	9-21
9.5.3	Mobile Cranes/Boom Trucks	9-27
9.5.4	Forklift Trucks	9-35
9.5.5	Written Procedure Requirements	9-40

DRAFT

FIGURES

9-1	Wheel-Mounted Crane (Single Control Station)	9-3
9-2	Crawler Crane	9-3
9-3	Wheel-Mounted Crane (Multiple Control Station)	9-3
9-4	Locomotive Crane	9-3
9-5	Wheel-Mounted Crane-Telescoping Boom (Rotating Control Station)	9-4
9-6	Wheel-Mounted Crane-Telescoping Boom (Single Control Station)	9-4
9-7	Wheel-Mounted Crane-Telescoping Boom (Multiple Control Station)	9-4
9-8	Crawler Crane-Telescoping Boom	9-4
9-9	Commercial Truck-Mounted Crane-Telescoping Boom	9-5
9-10	Commercial Truck-Mounted Crane-Nontelelescoping Boom	9-5
9-11	Forklift Truck	9-6
9-12	Standard Hand Signals for Controlling Crane Operations	9-22
9-13	Danger Zone for Cranes and Lifted Loads Operating Near Electrical Transmission Lines	9-31
9-14	Standard Hand Signals for Controlling Forklift Operators	9-38

TABLES

9-1	Maximum Allowable Wear at any Point of Link	9-17
9-2	Safe Working Distance From Power Lines	9-30

DEPARTMENT OF ENERGY HOISTING & RIGGING MANUAL	TITLE: CONSTRUCTION HOISTING & RIGGING EQUIPMENT REQUIREMENTS NUMBER: 9.0 REV: 00/91
---	---

ISSUE NO. 4

9.0 CONSTRUCTION HOISTING & RIGGING EQUIPMENT REQUIREMENTS

9.1 Introduction

The versatility of hoisting and rigging equipment makes it extremely useful on construction projects. Improper and unsafe use, however, can result in serious accidents.

This section outlines the requirements for the safe use of hoisting and rigging equipment on construction projects at DOE installations.

9.2 Definitions

AUTHORIZED: Assigned by a duly constituted administrative or regulatory authority to perform a specific function.

QUALIFIED INSPECTOR: One whose competence is recognized by the authority having jurisdiction and whose qualification to perform specific inspection activities has been determined, verified, and attested to in writing.

CRANE, MOBILE: For the purposes of this procedure, mobile cranes are defined as wheel mounted cranes, truck cranes, and crawler cranes.

- a. A "wheel mounted crane" consists of a rotating structure with power plant, operating machinery, and boom, mounted on a base or platform equipped with axles and rubber-tired wheels for travel. The base is usually propelled by the engine in the superstructure, but it may be equipped with a separate engine controlled from the superstructure (see Figures 1-10).
- b. A "Truck mounted crane" consists of a rotating superstructure with power plant, operating machinery and boom, mounted on an automotive truck equipped with a power plant for travel.

Commercial truck-mounted cranes are included in this category (see Figures 1-10).

- c. A "crawler crane" consists of a rotating superstructure with power plant, operating machinery and boom, mounted on a base, equipped with crawler treads for travel (see Figures 1-10).

CRITICAL ITEM: A part, assembly, component, or piece of equipment designated as critical by the responsible management, because the dropping, upset, or collision of it could: (a) cause damage that would result in schedule delay; (b) cause undetectable damage that could jeopardize future operation or safety of the facility; or (c) result in significant release of radioactivity or other undesirable material. Critical items may include pumps, heat exchangers, piping subassemblies, other primary-system components, fuel assemblies, large radiation-shielded shipping casks, or other items which require special care in handling because of size, weight, installation in close-tolerance receptors, fragility, extreme susceptibility to damage, or other unusual factors.

CRITICAL SERVICE: The use of equipment or accessories for hoisting, rigging, or handling of High-Consequence or Special-High-Consequence Loads.

FORKLIFT TRUCK: A high lift self-loading truck, equipped with load carriage and forks, for transporting and tiering loads (see Figure 11). Lift, High-Consequence: High consequence items and lifts are parts, components, assemblies, or lifting operations designated as such by the responsible management, because the effect of dropping, upset, or collision of items could:

DRAFT

DEPARTMENT OF ENERGY HOISTING & RIGGING MANUAL	TITLE: CONSTRUCTION HOISTING & RIGGING EQUIPMENT REQUIREMENTS NUMBER: 9.0 REV: 00/91
---	---

- a. Cause significant work delay as determined by appropriate management personnel.
- b. Cause undetectable damage resulting in future operations or safety problems.
- c. Result in significant release of radioactivity or other undesirable conditions as determined by appropriate management personnel.
- d. Present a potentially unacceptable risk of personnel injury or property damage.
- e. This category of lift applies when the load imposed upon the equipment to be used will be less than 75% of the rated capacity.

NOTE: In some referenced documents, the term "high-consequence" is replaced by the term "critical".

LIFT, ORDINARY: Any lift not designated as a High-Consequence Lift or a Special-High-Consequence Lift.

LIFT, SPECIAL-HIGH-CONSEQUENCE: Special-High-Consequence Lifts must meet High-Consequence Lift criteria where the load imposed upon the material-handling equipment will equal or exceed 75% of the rated capacity.

PERSON-IN-CHARGE (PIC): The manager or other responsible person (other than the equipment operator) appointed to be responsible for the safe handling of high-consequence or non-high-consequence items in, around, or above spaced in which high-consequence items are located.

QUALIFIED: A person, designated by management, who by possession of a recognized degree, certificate, or professional standing, or who by extensive knowledge, training, and experience, has successfully demonstrated his ability to solve problems relating to the subject.

QUALIFIED ENGINEER: Qualified Engineering Organization: An engineer or engineering organization whose competence in evaluation of the type of equipment in question has been demonstrated to the satisfaction of the cognizant manager.

QUALIFIED OPERATOR: One whose competence to operate equipment safely and effectively (including the ability to accurately spot and control loads) can be demonstrated to and accepted by responsible management.

QUALIFIED RIGGER: One whose competence in this skill has been demonstrated by experience accepted as satisfactory by the cognizant manager.

QUALIFIED RIGGING SPECIALIST: One whose competence in this skill has been demonstrated by extensive experience and is acknowledged as satisfactory by the cognizant manager.

DEPARTMENT OF ENERGY HOISTING & RIGGING MANUAL	TITLE: CONSTRUCTION HOISTING & RIGGING EQUIPMENT REQUIREMENTS NUMBER: 9.0 REV: 00/91
---	--

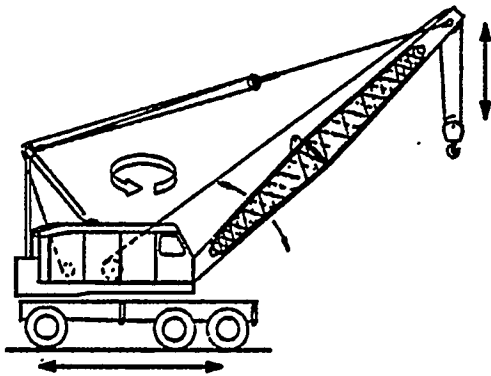

**Figure 9-1. Wheel-Mounted Crane
(Single Control Station)**

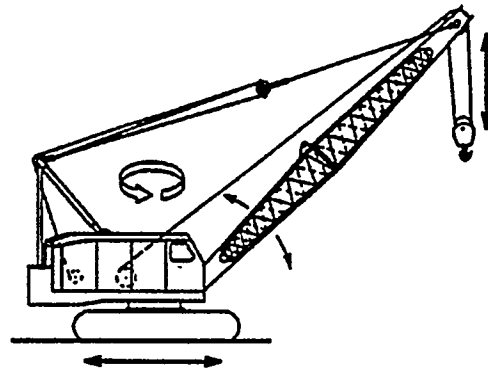
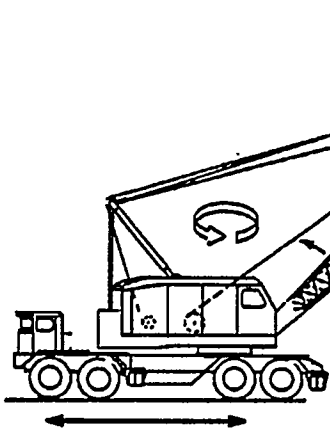

Figure 9-2. Crawler Crane



**Figure 9-3. Wheel-Mounted Crane
(Multiple Control Station)**

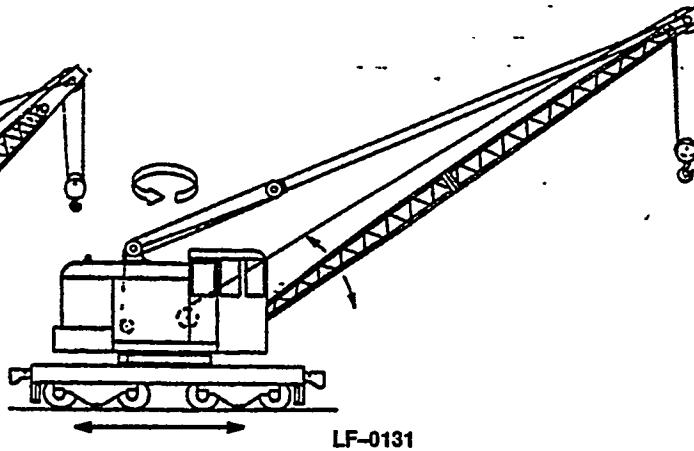

Figure 9-4. Locomotive Crane Boom

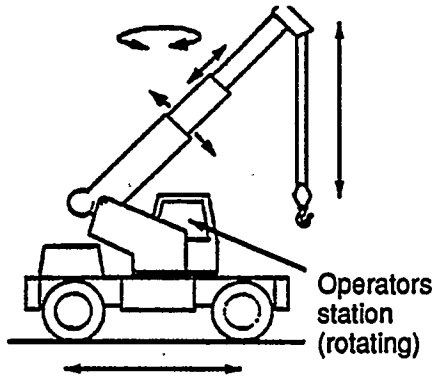

Figure 9-5. Wheel-Mounted Crane—
Telescoping Boom (Single Control
Station)

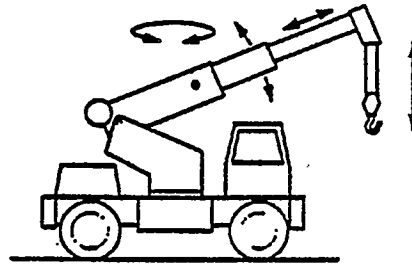

Figure 9-6. Wheel-Mounted Crane—
Telescoping Boom (Single Control
Station)

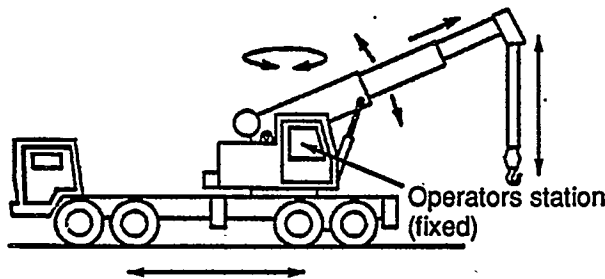

Figure 9-7. Wheel-Mounted Crane—
Telescoping Boom (Multiple Control
Station)

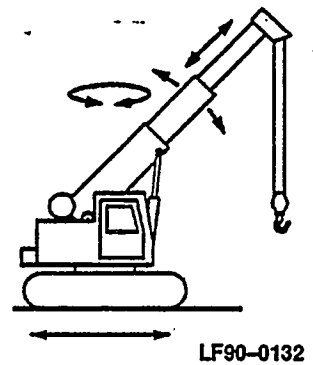

Figure 9-8. Crawler Crane—Telescoping Boom

**DEPARTMENT OF
ENERGY
HOISTING & RIGGING
MANUAL**

**TITLE: CONSTRUCTION HOISTING & RIGGING
EQUIPMENT REQUIREMENTS**

NUMBER: 9.0

REV: 00/91

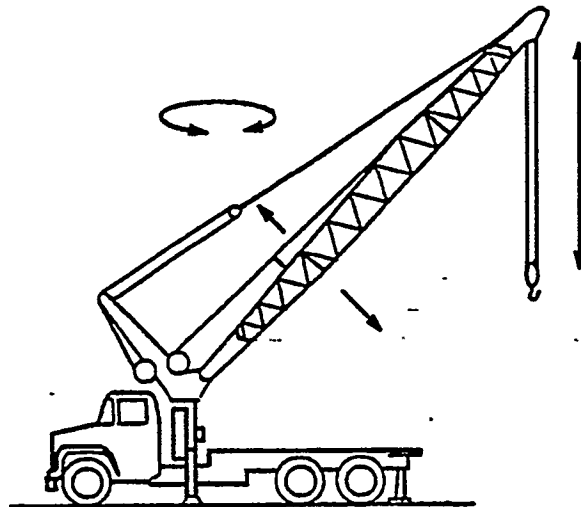
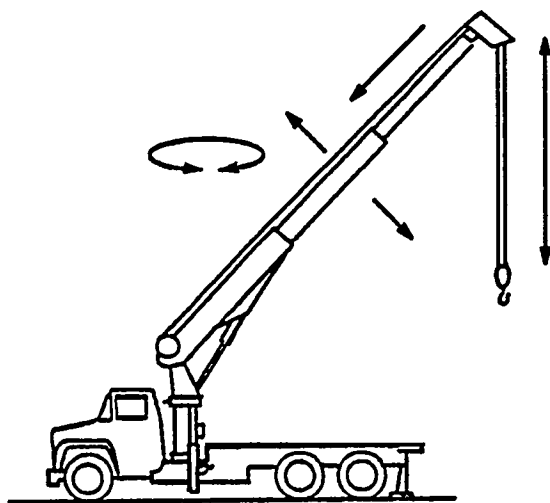

LF90-0133

Figure 9-9. Commercial Truck-Mounted Figure Crane—Telescoping Boom

Figure 9-10. Commercial Truck-Mounted Crane—Nontelelescoping Boom

GENERAL NOTE TO FIGURES 9-5 THROUGH 9-10:

The boom may have a base boom structure of sections (upper and lower) between or beyond which additional sections may be added to increase its length, or it may consist of a base boom from which one or more boom extensions are telescoped for additional length. These illustrations show some types.

DRAFT

**DEPARTMENT OF
ENERGY
HOISTING & RIGGING
MANUAL**

**TITLE: CONSTRUCTION HOISTING & RIGGING
EQUIPMENT REQUIREMENTS**

NUMBER: 9.0

REV: 00/91

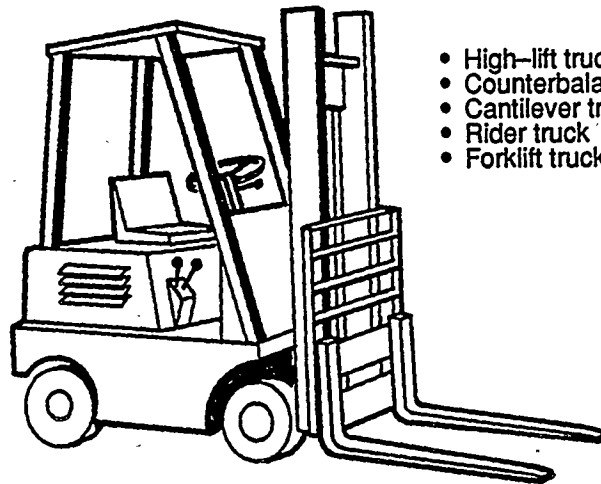

- High-lift truck
- Counterbalanced truck
- Cantilever truck
- Rider truck
- Forklift truck

LF90 0134

Figure 9-11. High Lift Truck Counterbalanced Truck Cantilever Truck Rider Truck Forklift Truck.

DRAFT

DEPARTMENT OF ENERGY HOISTING & RIGGING MANUAL	TITLE: CONSTRUCTION HOISTING & RIGGING EQUIPMENT REQUIREMENTS NUMBER: 9.0 REV: 00/91
---	---

9.3 Personnel Qualifications

9.3.1 Qualified Operators

Operators of hoisting equipment shall meet the following requirements:

- a. Be at least 18 years of age.
- b. Understand spoken and written English.
- c. Have basic knowledge and understanding of equipment operating characteristics, capabilities, and limitations including: equipment-rated capacity and effect of variables on capacity, safety features, required operating procedures, and requirements of this chapter.
- d. Demonstrate to appropriate management, skill in manipulations and control of equipment through all phases of operation.
- e. Any Professional Operator who can produce evidence of qualification under the requirements of 49 CFR 391.41 shall be deemed to have satisfied all requirements through Paragraph g. of this section.
- f. Have vision of at least 20/30 Snellen in one eye, and 20/50 in the other, with or without corrective lenses.
- g. Be able to distinguish colors, regardless of position of colors, if color differential is required for operation.
- h. Hearing, with or without hearing aid, must be adequate for a specific operation.
- i. Have sufficient strength, endurance, agility, coordination, and speed of reaction to meet the demands of equipment operation.
- j. Evidence of physical defects, or emotional stability which could render the operator a hazard to himself/herself or others, or which in the opinion of the examiner could interfere with the operator's safe performance may be sufficient cause for disqualification. In such cases, specialized clinical or medical judgments and tests may be required.

NOTE: Medications being taken should be evaluated on a case by case basis.

- k. Evidence that an operator is subject to seizures or loss of physical control shall be sufficient reason for disqualification. Specialized medical tests may be required to determine these conditions.
- l. Special consideration must be given to cases where operators are required to climb up and down vertical ladders, circa 18.3 m (60 ft), in a reasonable length of time. This is particularly important where the ladders may be the means of egress in emergency situations.

NOTE: Additional written documentation, i.e., a resume, which outlines the operators experience and/or training to operate the specific equipment to be used shall be furnished by the operator and approved by responsible management prior to making any HIGH-CONSEQUENCE or SPECIAL-HIGH-CONSEQUENCE LIFT.

DRAFT

9.3.2 Qualified Riggers

Qualified Riggers shall meet the following requirements:

- a. Be at least 18 years of age.
- b. Understand spoken and written English.
- c. Have basic knowledge and understanding of equipment—operating characteristics, capabilities, and limitations. Understand rigging principles as applied to the job for which they are to be qualified.
- d. Demonstrate to appropriate management personnel, skill in utilizing rigging principles.
- e. Shall not have a detectable or known disease or physical malfunction that would render the employee incapable of safe operation or rigging duties. Where any loss or loss of function of an upper or lower extremity exists, the acceptability of the candidate shall be the decision of the supervisor, after consulting with the designated physician.
- f. Have normal depth perception, field of vision, reaction time, manual dexterity and coordination.

9.3.3 Person-In-Charge (PIC)

The PIC shall be a Qualified Person, or shall be assisted by a Qualified Person, experienced in using hoisting and rigging equipment of the type to be used; preparing and reviewing drawings, procedures, and equipment assignments; and supervising the job.

When handling High-Consequence material, the PIC is appointed to direct the lift. Material handling that is critical to operations may require designation of a PIC to supervise handling. When the item is large, expensive, irregular in shape, the center of gravity is difficult to determine, and the risk is high, a special person is designated as PIC.

An equipment-operator foreman is usually the assistant. The person designated as the PIC may be: (1) a supervisor familiar with the High-Consequence material-handling operations; (2) an engineer with special knowledge of the material; or (3) a person with special knowledge of the equipment and handling necessary. A competent PIC should have training and experience to assure capability for:

Organizing and handling pre-job planning.

Supervising pre-job organization and procedure meetings.

Knowing the requirements for tests of equipment, slings, tackle, etc., for proper certification and documentation.

9.4 Inspection and Testing

9.4.1 General

- a. Only equipment which has been built to nationally recognized manufacturers' standards shall be used at DOE installations. Existing equipment shall be brought to an acceptable level of compliance as determined by an appropriate level of the construction management

DRAFT

**DEPARTMENT OF
ENERGY
HOISTING & RIGGING
MANUAL**

**TITLE: CONSTRUCTION HOISTING & RIGGING
EQUIPMENT REQUIREMENTS**

NUMBER: 9.0

REV: 00/91

contractor. In some instances the requirements of this manual exceed those of the references and in such instances the requirements of this manual shall prevail.

- b. Equipment with discrepancies which may affect the safety of the operation shall not be allowed to operate at DOE-controlled installations. No repairs, modifications, or additions which affect the capacity or safe operation of the equipment shall be made by the contractor without the manufacturer's written approval.
- c. Once mobile cranes, boom trucks, and forklifts have left the control of the construction management contractor and are then returned, they shall be reinspected and reload tested prior to making a high-consequence/special-high-consequence lift.

9.4.2 Mobile Cranes/Boom Trucks—Inspection

a. Ordinary Lifts:

- (1) Prior to use at a DOE installation, mobile cranes/boom trucks will be inspected and approved for operation by appropriate construction management contractor personnel or those having overall responsibility for ordinary hoisting operations.
- (2) Inspection procedures for cranes in regular service are divided into two general classifications based upon the intervals at which inspections should be performed. The intervals, in turn, are dependent upon the nature of the critical components of the crane and the degree of their exposure to wear, deterioration, or malfunction. The two general classifications are designated as "frequent" and "periodic," with intervals between inspections as defined below:
 - (a) Frequent inspection: daily.
 - (b) Periodic inspection: monthly.
- (3) Frequent inspections shall cover:
 - (a) All control mechanisms for excessive wear of components and contamination by lubricants or other foreign matter.
 - (b) All safety devices for malfunction.
 - (c) Deterioration or leakage from air or hydraulic systems.
 - (d) Crane hooks for deformations or cracks. Hooks which have cracks, or more than 15% in excess of normal throat opening, or more than 10° twist from the plane of the unbent hook, shall be discarded.
 - (e) Rope reeving for noncompliance with crane manufacturer's recommendations.
 - (f) Electrical apparatus for malfunctioning, signs of excessive deterioration, dirt, and moisture accumulation.
 - (g) Hydraulic systems for proper oil level.
 - (h) Boom sections for structural integrity.

DRAFT

**DEPARTMENT OF
ENERGY
HOISTING & RIGGING
MANUAL**

**TITLE: CONSTRUCTION HOISTING & RIGGING
EQUIPMENT REQUIREMENTS**
NUMBER: 9.0 **REV: 00/91**

- (i) Frequent inspections shall be performed at the start of each shift or prior to use if not in regular service. Deficiencies shall be corrected immediately prior to use of the machine/equipment. Written records shall be kept at monthly intervals and made available to appropriate construction management personnel.
- Inspect wire rope and replace those that are worn, kinked, crushed, or badly frayed. Be particularly careful about boom-hoist ropes and pendants.
 - Inspect the machine for loose, worn, or damaged parts.
- (4) Periodic inspections shall be made for:
- (a) Loose bolts or rivets.
 - (b) Cracked or worn sheaves and drums.
 - (c) Worn, cracked, or distorted parts such as pins, bearings, shafts, gears, rollers, and locking devices.
 - (d) Excessive wear on brake and clutch system parts, linings, pawls, and ratchets.
 - (e) Load, boom angle, and other indicators over their full ranges for any inaccuracies.
 - (f) Gasoline, diesel, electrical, or other power plants for improper performance or noncompliance with safety requirements.
 - (g) Radiators and oil coolers, for leakage, improper performance, or blockage of air passages.
 - (h) Hooks: Dye penetrant, magnetic particle, or other suitable crack-detecting inspections should be performed at least once each year.
 - (i) Travel steering, braking, and locking devices for malfunctioning.
 - (j) Excessively worn or damaged tires.
 - (k) Rust on hydraulic piston rods and control valves.
 - (l) Cleanliness of oil filters and oil strainers.
 - (m) All hydraulic hoses, particularly those which flex in normal operation of crane functions, should be visually inspected once every working day. A thorough inspection of all hoses, fittings, and rigid-tube lines should be made at least once a month. Any deterioration should be carefully examined and a determination made as to whether further use of the component would constitute an unsafe condition. The following conditions should be sufficient reason for consideration of replacement.
 - i. Any evidence of hydraulic oil leakage at the surface of the flexible hose or its junction with the metal end couplings.

DRAFT

**DEPARTMENT OF
ENERGY
HOISTING & RIGGING
MANUAL**

**TITLE: CONSTRUCTION HOISTING & RIGGING
EQUIPMENT REQUIREMENTS**

NUMBER: 9.0

REV: 00/91

- ii. Any blistering or abnormal deformation to the outer covering of the hydraulic hose.
 - iii. Hydraulic oil leakage at any threaded or clamped joint, that cannot be eliminated by normal tightening or other recommended procedures.
 - iv. Evidence of excessive abrasion or scrubbing on the outer surface of a hose, rigid tube, or hydraulic fitting. Measures shall be taken immediately to eliminate the interface or to otherwise protect the components.
- (n) The following may be reason for replacement or repair of pumps and motors: loose bolts or fasteners; leaks at joints between sections; shaft-seal leaks, unusual noises or vibrations; loss of operating speed; and excessive heating of the hydraulic oil.
 - (o) The following may be reason for replacement or repair of valves: cracks in valve housing; improper return of spool to neutral position; leaks at spools or joints; sticking spools; and failure of relief valves to actuate at the correct pressure setting.
 - (p) The following may be reason for replacement or repair of cylinder: drifting caused by oil leaking across the piston; rod seals leaking; leaks at welded joints; scored, nicked, or dented cylinder rods; dented case (barrel); and loose or deformed rod eyes or connecting joints.
 - (q) Filters: Evidence of rubber particles on the filter element may indicate deterioration of hoses, "O" rings, or other rubber components. Metal chips or pieces on the filter may denote failure in pumps, motors, or cylinders. Further checking will be necessary to determine the origin of the problem before corrective action can be taken.
 - (r) Inspection records shall be kept on file and readily available to appropriate construction management personnel.
 - (s) All running ropes in continuous service should be visually inspected once every working day. A thorough full layout inspection of all ropes in use shall be made at least annually, and a full written, dated, and signed inspection report indicating rope condition shall be kept on file and readily available. All inspections shall be performed by an appointed or authorized person. Any deterioration, resulting in appreciable loss of original strength such as described in v. below, shall be carefully noted, and determinations shall be made as to whether further use of the rope would constitute an unsafe condition:
 - i. Reduction of rope diameter below nominal diameter due to loss of core support, internal or external corrosion, or wear of outside wires.
 - ii. A number of broken outside wires, and the distribution or concentration of such broken wires.
 - iii. Worn outside wires.

DRAFT

DEPARTMENT OF ENERGY HOISTING & RIGGING MANUAL	TITLE: CONSTRUCTION HOISTING & RIGGING EQUIPMENT REQUIREMENTS NUMBER: 9.0 REV: 00/91
---	--

- iv. Corroded or broken wires at end connections.
- v. Corroded, cracked, bent, worn or improperly applied end connections.
- vi. Severe kinking, crushing, cutting, or unstranding.
- (t) Heavy wear and/or broken wires may occur in sections in contact with equalizer sheaves, other sheaves where rope travel is limited, or with saddles. Particular care shall be taken to inspect ropes at these locations.
- (u) All rope which has been idle for a month or more, due to shutdown or storage of a crane on which it is installed, shall be given a thorough inspection before it is placed in service. This inspection shall be for all types of deterioration and shall be performed by an appointed or authorized person. A written and dated report of the rope condition shall be filed.
- (v) No precise rules can be given for determination of the exact time for replacement of wire rope, since many variable factors are involved. Safety in this respect depends largely upon the use of good judgment, by an appointed or authorized person, in evaluating remaining strength in a used rope after allowance for deterioration disclosed by inspection. Safety of rope operation depends upon this remaining strength. Conditions, such as the following, should be sufficient reason for questioning rope safety and for consideration of replacement:
 - i. In running ropes, 6 randomly distributed broken wires in one rope lay, or 3 broken wires in one strand in one rope lay.
 - ii. Wear of one-third the original diameter of outside individual wires.
 - iii. Kinking, crushing, birdcaging, or any other damage resulting in distortion of the rope structure.
 - iv. Evidence of any heat damage from any cause.
 - v. Reductions from nominal diameter of more than 0.4 mm (1/64 in.) for diameters up to and including 7.9 mm (5/16 in.), 0.8 mm (1/32 in.) for diameters 9.5 mm (3/8 in.) to and including 12.7 mm (1/2 in.), 1.2 mm (3/64 in.) for diameters 14.3 mm (9/16 in.) to and including 19.1 mm (3/4 in.), 1.6 mm (1/16 in.) for diameters 22.2 mm (7/8 in.) to and including 28.6 mm (1-1/8 in.), and 2.4 mm (3/32 in.) for diameters 31.8 mm (1-1/4 in.) to and including 38.1 mm (1-1/2 in.).
 - vi. In standing ropes, more than two broken wires in one lay in sections beyond end connections, or more than one broken wire at an end connection.
- (w) In order to establish data as a basis for judging the proper time for replacement, a continuing inspection record shall be maintained. This record shall cover points of deterioration listed above. (Discarded rope shall not be used for slings.)
- (x) Replacement rope shall be of the same size, grade, and construction as the discarded rope, unless otherwise recommended by a wire rope or crane manufacturer due to actual working condition requirements.

DRAFT

DEPARTMENT OF ENERGY HOISTING & RIGGING MANUAL	TITLE: CONSTRUCTION HOISTING & RIGGING EQUIPMENT REQUIREMENTS NUMBER: 9.0 REV: 00/91
---	---

b. High-Consequence/Special-High-Consequence Lifts

- (1) All provisions for ordinary lifts shall apply.
- (2) Equipment shall receive a major inspection when first assigned to this service and at 12 month intervals thereafter. This shall be a visual inspection by a qualified inspector. Written, dated and signed inspection reports shall be kept on file and readily available to appointed personnel. Major inspections shall include all points and items covered by the equipment manufacturer's recommendations (when available). Periodic inspection, in accordance with 9.4.2a(4), load testing in accordance with Section 9.4.3, and nondestructive examination (magnetic particle or liquid penetrant) of hooks and, when required by the inspector, welds, bearings, or other suspect loadbearing parts shall be done at the specified intervals. NDE shall be in accordance with pertinent sections of applicable ASTM Standards.

Annual maintenance shall be carried out prior to or during major inspections.

9.4.3 Mobile Crane/Boom Truck—Testing

a. High-Consequence Lifts

- (1) Equipment shall be load tested when assigned to make a high-consequence lift and thereafter at 12-month intervals, and when specified in the procedures if deemed necessary by appropriate construction management personnel due to ground conditions, weather or peculiar circumstances. The load test shall be conducted by a qualified inspector. Load tests shall be made in an area where no critical items or equipment for handling critical items are installed, being worked on, or stored. Before starting the load test, equipment shall be inspected in accordance with Section 9.4.2. Defective parts shall be replaced or repaired before starting the load test.
- (2) Routine load tests may be made with a hook load equal to 100% of the rated capacity of the crane, or load tests shall be made with a hook load of 110% of the combined weight of the item to be lifted and the lifting tackle. In no case shall the load test exceed the rated capacity of the equipment. Test results shall be recorded.
- (3) **Static Test:** Equipment shall hold the test load for 10 minutes, or the time required to check all primary load-bearing parts while under strain without slippage, damage, or permanent deformation of any part of the equipment. Hoisting equipment and winches shall be tested at maximum run-out of the hoisting ropes or chain, when practical.
- (4) **Dynamic Test:** Hoisting equipment shall be operated through at least two complete cycles of all movement which the equipment will encounter in service while supporting the test load. As a minimum, the test load shall be raised far enough for all drums, sheaves, gears, or other rotating parts of the hoisting mechanism to complete at least one or if possible two complete revolutions, in the clearance available; then lowered until the load comes within 2-3 inches of the ground and held at this level for 1 minute. The hoisting cycle shall be repeated at least one more time. Tests shall be made by the operator who normally operates the equipment, who shall demonstrate his/her ability to positively control the load during all lateral, rotational, and vertical motions which will be encountered in service. At least once during the lifting portion of the hoisting cycle and once during the lowering cycle, power to the hoisting equipment shall be completely turned off. There shall be no slippage of the load or overheating of the brakes.

DRAFT

DEPARTMENT OF ENERGY HOISTING & RIGGING MANUAL	TITLE: CONSTRUCTION HOISTING & RIGGING EQUIPMENT REQUIREMENTS NUMBER: 9.0 REV: 00/91
---	---

- b. Special-High-Consequence Lifts
- (1) Equipment shall be load tested before lifting any special-high-consequence load. All other provisions for high-consequence load testing as outlined above shall apply.
 - (2) Load test records shall be maintained and made available for examination by the construction management contractor.

9.4.4 Forklift Trucks—Inspection

- a. Ordinary Lifts
- (1) Prior to initial use, all new, altered, modified, or extensively repaired forklifts shall be inspected to assure compliance with the provisions of this Manual.
 - (2) Brakes, steering mechanisms, control mechanisms, warning devices, lights, governors, lift-overload devices, guards, and safety devices shall be inspected regularly and maintained in a safe-operating condition.
 - (3) All parts of lift/tilt mechanisms and frame members shall be carefully and regularly inspected and maintained in a safe operating condition.
 - (4) Special trucks or devices, designed and approved for operation in hazardous areas, shall receive special attention to ensure that the original, approved safe-operating features are preserved by maintenance.
 - (5) Fuel systems shall be checked for leaks and condition of parts. Special consideration shall be given in the case of a leak in the fuel system. Action shall be taken to prevent the use of the truck until the leak has been corrected.
 - (6) All hydraulic systems shall be regularly inspected and maintained in conformance with good practice. Tilt cylinders, valves, and other similar parts shall be checked to assure that "drift" has not developed to the extent that it would create a hazard.
 - (7) Capacity, operation, and maintenance-instruction plates shall be maintained in legible condition.
 - (8) Batteries, motors, controllers, limit switches, protective devices, electrical conductors, and connections shall be inspected and maintained in conformance with good practice. Special attention shall be paid to the condition of electrical insulation.
- b. High-Consequence/Special-High-Consequence Lifts
- (1) All provisions for ordinary lifts shall apply.
 - (2) An inspection shall be conducted prior to making a critical lift and annually thereafter when assigned to critical service or when specified in the procedures. The inspection shall be conducted by a qualified inspector.

9.4.5 Forklift Truck—Testing

- a. Load Testing-High-Consequence/Special-High-Consequence Lifts
- (1) A load test shall be conducted prior to making a critical lift and annually thereafter when assigned to critical service or when specified in the procedures. The inspection

DEPARTMENT OF ENERGY HOISTING & RIGGING MANUAL	TITLE: CONSTRUCTION HOISTING & RIGGING EQUIPMENT REQUIREMENTS NUMBER: 9.0 REV: 00/91
---	---

shall be conducted by a qualified inspector whose qualification to perform specific inspection activities has been determined, verified, and attested to in writing. Before starting the load test, the forklift shall be inspected as defined in Section 9.4.4(a) above. NDE of the forks shall be made as part of the inspection.

- (2) Routine load tests may be made with a load equal to 100% of the rated capacity of the forklift or with a load equal to 110% of the combined weight of the item to be lifted and any lifting tackle. In no case shall the load test exceed the rated capacity of the equipment.
- (3) Static Test: Equipment shall demonstrate ability to withstand the appropriate test load for a period of at least 10 minutes without permanent deformation or apparent damage. Load slippage shall not be greater than a maximum of 3 inches vertically and 1 inch horizontally at the cylinder.
- (4) Load test records shall be maintained and made available for examination by the construction management contractor.

9.4.6 Slings – Inspection

a. Ordinary Lifts

(1) Wire Rope

- (a) All slings shall be visually inspected each day prior to use. Any deterioration which could result in an appreciable loss of original strength shall be carefully noted, and determination made whether further use of the sling would constitute a safety hazard.
- (b) Conditions, such as the following, shall be sufficient reason for questioning sling safety and for consideration of replacement:
 - i. Six randomly distributed broken wires in one rope lay, or three broken wires in one strand in one rope lay.
 - ii. Wear or scraping of one-third the original diameter of outside individual wires.
 - iii. Kinking, crushing, birdcaging, or any other damage resulting in distortion of the rope structure.
 - iv. Evidence of heat damage.
 - v. End attachments that are cracked, deformed, or worn.
 - vi. Hooks that have been opened more than 15% of the normal throat opening measured at the narrowest point, or twisted more than 10° from the plane of the unbent hook.
 - vii. Corrosion of the rope or end attachments.

DRAFT

DEPARTMENT OF ENERGY HOISTING & RIGGING MANUAL	TITLE: CONSTRUCTION HOISTING & RIGGING EQUIPMENT REQUIREMENTS
	NUMBER: 9.0 REV: 00/91

- vii. Assemblies with cracked hooks or other end attachments shall be removed from service.
 - viii. Assemblies with such defects shall be reconditioned or repaired prior to return to service.
 - ix. If the depth of the gouge or rounded-out portion exceeds the values shown in the following table, the assembly shall be removed from service.
- (b) High-Consequence/Special-High-Consequence Lifts
- (1) All provisions for ordinary lifts shall apply.

Table 9-1. Maximum Allowable Wear at Any Point of Link

Chain Size (in.)	Maximum Allowable Wear (in.)
1/4	3/64
3/8	5/64
1/2	7/64
5/8	9/64
3/4	5/32
7/8	11/64
1	3/16
1-1/8	7/32
1-1/4	1/4
1-3/8	9/32
1-1/2	5/16
1-2/4	11/32

- (2) An inspection shall be conducted prior to making a critical lift and thereafter at 6 month intervals when assigned to critical service or when specified in the procedures. The inspection shall be conducted by a qualified inspector.
- (3) Reports of inspections shall be maintained and shall be available for inspection by designated construction management personnel.

9.4.7 Sling-Testing (Includes wire-rope, synthetic-mesh and steel-chain slings)

- a. High-Consequence/Special-High-Consequence Lifts
 - (1) A load test shall be conducted prior to making a critical lift and thereafter at 6 month intervals when assigned to critical service. The load test shall be conducted by a qualified inspector. As an alternate to initial load testing, certification by the manufacturer that the sling has survived a proof test of 200% of the manufacturer's load rating shall be provided.

DRAFT

**DEPARTMENT OF
INDUSTRY
HOISTING & RIGGING
REGULATIONS**

**TITLE: CONSTRUCTION HOISTING & RIGGING
EQUIPMENT REQUIREMENTS**

NUMBER: 9.0

REV: 00/91

- (2) Load tests shall be no less than 150% of the maximum static load that will be encountered in service, and shall be accurate within -5% , $+0\%$ of stipulated values.

4.8 Rigging Accessories – Inspection

a. Ordinary Lifts

- (1) Shackles, rings, eyebolts, lifting bars, rigging assemblies, and hooks shall be inspected at the beginning of each shift in which they are to be used.
- (2) Shackles, rings, and similar items shall be inspected for wear, corrosion, spreading, and deformation, and shall be replaced if deformation exceeds 15% of their new condition. Shackle pins shall be replaced if they show any sign of failure in shear.
- (3) Lifting bars and spreaders shall be inspected for signs of failure in bending, and shall be replaced if permanently bent more than 1/2 inch in 10 feet, or twisted more than 5° out of the original plane. Hook attachment welds shall be examined for cracks and signs of failure in tension.
- (4) Hooks having any of the following deficiencies shall be removed from service, unless a qualified person approves their continued limited use:
 - (a) Crack(s).
 - (b) Wear exceeding 10% of the original dimension.
 - (c) A bend or twist exceeding 10° from the plane of the unbent hook.
 - (d) Increase in throat opening exceeding 15% from the new condition.
 - (e) If a latch is provided, and it becomes inoperative because of wear or deformation, or fails to fully bridge the throat opening, the hook shall be removed from service until the device has been repaired or replaced; or the throat opening has been assessed per iv. above.
 - (f) If hooks are painted, a visual inspection should take the coating into consideration. Surface variations can disclose evidence of heavy or severe service. The surface condition may then call for stripping the paint in such instances.

(b) High-Consequence/Special-High-Consequence Lifts

- (1) All provisions for ordinary lifts shall apply.
- (2) An inspection shall be conducted prior to making a critical lift and annually thereafter when assigned to critical service or when specified in the procedures. The inspection shall be conducted by a certified inspector whose qualification to perform specific inspection activities has been determined, verified, and attested to in writing.
- (3) Hooks and welds shall be examined by an NDE method in accordance with the sections of ASTM Standards applicable to the method of examination used. NDE of shackles, links, rings, and other accessories shall be made in accordance with the same standards, when directed by the cognizant construction management contractor.

DRAFT

DEPARTMENT OF ENERGY HOISTING & RIGGING MANUAL	TITLE: CONSTRUCTION HOISTING & RIGGING EQUIPMENT REQUIREMENTS NUMBER: 9.0 REV: 00/91
---	---

- (4) Reports of all inspections shall be maintained. Records should include item identification, characteristics inspected, observations, disposition if any, and date of actions. Records shall be kept readily available for inspection by designated construction management personnel.

9.4.9 Rigging Accessories – Testing

a. General

- (1) Handling fixtures, and rigging accessories shall be tested as a unit when practical. When necessary, individual parts of such assemblies may be tested individually with the approval of the inspector.
- (2) Test loads shall be accurate to within - 5%, + 0% of stipulated values.
- (3) Test loads shall be arranged so that actual service-load conditions are duplicated to the maximum possible extent, including sling angles, etc.
- (4) All parts showing damage or permanent deformation as a result of load testing shall be replaced. Replacement parts shall be load tested in accordance with this paragraph. Discarded parts shall be destroyed.
- (5) Multi-leg lift assemblies that are not statically determinate^a shall be load tested based on any two legs sharing the entire load. Legs not undergoing test shall be attached in a manner to ensure that load stability is not lost during the test.
- (6) Dynamometers/load cells shall be tested and calibrated at least once a year and when specified in the procedure before making a critical lift. This also applies if they have not been used in the previous 6 months.
- (7) No performance testing of hooks shall be required, except as is necessary to conform to the requirements for the equipment of which they are a part.

a. A lift configuration in which one or more members of the assembly must deform, within its elastic limit, in order to balance the load on all legs, is not considered to be statically determinate.

DEPARTMENT OF; ENERGY HOISTING & RIGGING MANUAL	TITLE: CONSTRUCTION HOISTING & RIGGING EQUIPMENT REQUIREMENTS NUMBER: 9.0 REV: 00/91
--	---

b. High-Consequence/Special-High-Consequence Lifts

- (1) A load test shall be conducted prior to making a critical lift and annually thereafter when assigned to critical service or when specified in the procedures. The inspection shall be conducted by a certified inspector whose qualification to perform specific inspection activities has been determined, verified, and attested to in writing. Load tests shall be conducted before making a critical lift and annually thereafter (if specified in the procedure).
- (2) Load tests shall be no less than 150% of the maximum static load that will be encountered in service, - 5%, + 0% of stipulated values.
- (3) If a test has not been completed by the end of the required period, the equipment shall not be used for High-Consequence/Special-High-Consequence Lifts until retesting has been completed.

9.5 Operating Practices

9.5.1 General

- a. The construction management contractor shall classify each lift into one of the following before the lift is made:
 - Ordinary
 - High-Consequence
 - Special-High-Consequence
- b. Special consideration should be given to the proper functioning of tires, horns, lights, batteries, controllers, lift systems (including load-engaging means, limit switches, etc.), brakes, and steering mechanisms. If at any time a lifting device is found to be defective or in any way unsafe, the matter shall be reported immediately to appropriate management and the unit shall be taken out of service until it has been restored to safe-operating condition or a determination has been made by the construction management contractor that the discrepancy will not adversely affect the operation of the unit.
- c. The safety of personnel and equipment shall be a first priority. Report or correct any unsafe condition immediately.
- d. If the visibility of the operator is impaired by dust, darkness, snow, fog or rain, strict supervision of the operation must be exercised, and if necessary, the equipment shall be withdrawn from service.
- e. Be alert while operating and always maintain eye contact with the load. If attention must be diverted elsewhere, discontinue operation first. Keep a signaler in full view if the load cannot be seen at all times.
- f. Never operate or allow anyone to operate until that person is thoroughly familiar with the machine, its operation and proper care.
- g. Be a good housekeeper. Keep the work area free of oil, grease, rags, buckets, barrels, and other hazards. Keep loose parts in a tool box. Use only nonflammable solutions for cleaning. Be sure shoe soles are clean and dry before operating brakes.

DRAFT



DEPARTMENT OF ENERGY HOISTING & RIGGING MANUAL	TITLE: CONSTRUCTION HOISTING & RIGGING EQUIPMENT REQUIREMENTS NUMBER: 9.0 REV: 00/91
---	---

- h. Replace all missing or broken guards and panels.
- i. Never tamper with safety devices.
- j. Have a fire extinguisher on hand and know how to use it. Be sure that it is checked regularly (at least monthly) to assure it is in working order.
- k. Check the motion controls for proper functioning at the start of each shift and/or prior to use if the crane is not in regular service.
- l. Make certain that no one is working on or close to the machine before starting the engine or beginning to move. Accessible areas within the swing radius of the rear of the rotating superstructure of the crane, either permanently or temporarily mounted, shall be barricaded in such a manner as to prevent an employee from being struck or crushed by the crane.
- m. Use caution when refueling. Stop the engine; do not permit smoking within 25 feet; never fill near an open flame. Keep metal funnels in contact with the filler tube to prevent static spark. Turn off the heater before fueling.
- n. Use both hands to mount and dismount. Never get on or off a moving machine, and never jump off.
- o. Hand signals shall be taken from only one person. A stop signal must be obeyed regardless of who gives it. The standard signals shown in this Chapter shall be used (see Figure 12).
- p. Many machines have ratings limited by factors other than machine stability. Never exceed the rated capacity.
- q. Make a "dry run" in tight areas; it will help determine the safest way to operate under existing conditions.
- r. Check loads before moving them. First, determine the load weight and check it against the capacity chart. Be sure the load is well secured and the hoist ropes are not kinked. The hoist ropes should be vertical and sudden starts and stops should be avoided.

9.5.2 Lifting Personnel

- a. No lifting, lowering, swinging, or traveling shall be done while a worker is on the hook, load, manlift platform, boom, or personnel-lifting device attached to the crane hoist rope, boom or tines except under the following conditions:
 - (1) The person specifically responsible for the overall work function to be performed shall determine that there is no practical, alternative way to perform the work, such as a ladder, scaffold, stairway, aerial lift or personnel hoist. If a determination is made that lifting by crane or forklift is required, the construction management contractor shall be notified and will approve the requirement prior to making the lift.

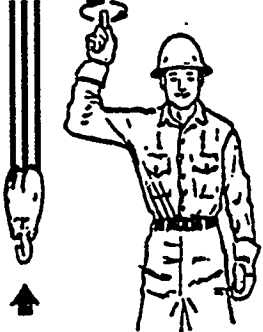
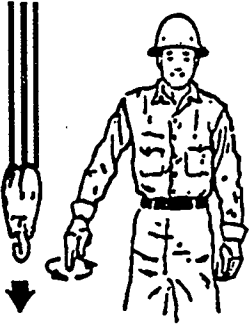
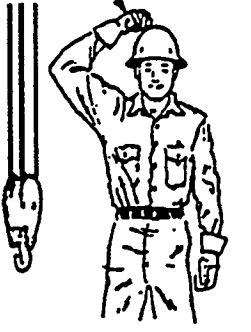
<p>DEPARTMENT OF ENERGY HOISTING & RIGGING MANUAL</p>	<p>TITLE: CONSTRUCTION HOISTING & RIGGING EQUIPMENT REQUIREMENTS</p>	<p>NUMBER: 9.0</p>	<p>REV: 00/91</p>
--	---	---------------------------	--------------------------

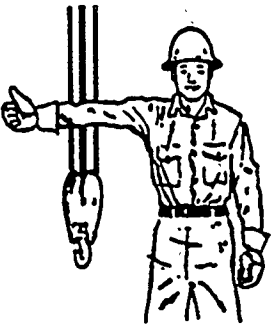
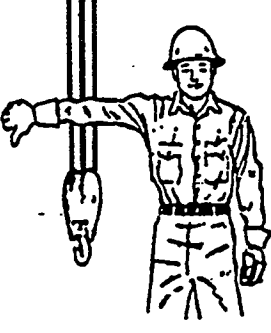
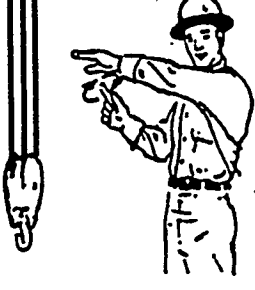
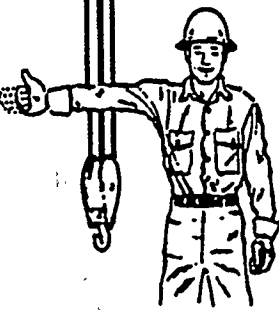
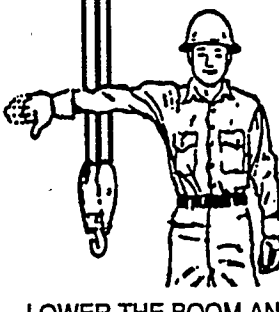
 <p>HOIST. With forearm vertical, forefinger pointing up, move hand in small horizontal circles.</p>	 <p>LOWER. With arm extended downward, forefinger pointing down, move hand in small horizontal circles.</p>	 <p>USE MAIN HOIST. Tap fist on head; then use regular signals.</p>
 <p>USE WHIPLINE (Auxiliary Hoist). Tap elbow with one hand, then use regular signals.</p>	 <p>RAISE BOOM. Arm extended, fingers closed, thumb pointing upward.</p>	 <p>LOWER BOOM. Arm extended, fingers closed, thumb pointing downward.</p>
 <p>MOVE SLOWLY. Use one hand to give any motion signal and place other hand motionless in front of hand giving the motion signal. (Hoist slowly shown as example.)</p>	 <p>RAISE THE BOOM AND LOWER THE LOAD. With arm extended, thumb pointing up, flex fingers in and out as long as load movement is desired.</p>	 <p>LOWER THE BOOM AND RAISE THE LOAD. With arm extended, thumb pointing down, flex fingers in and out as long as load movement is desired.</p>

LF90-0135

Figure 9-12. Standard Hand Signals for Controlling Crane Operations.

DRAFT

<p>DEPARTMENT OF ENERGY HOISTING & RIGGING MANUAL</p>	<p>TITLE: CONSTRUCTION HOISTING & RIGGING EQUIPMENT REQUIREMENTS</p> <p>NUMBER: 9.0</p>	<p>REV: 00/91</p>
--	---	--------------------------

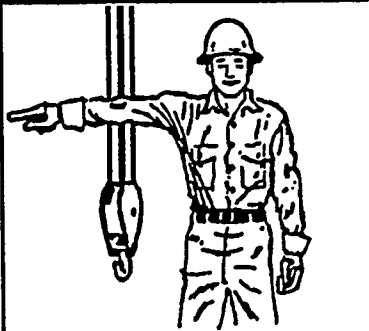
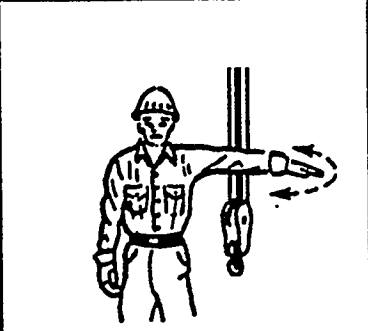
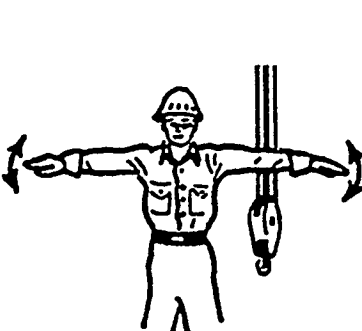
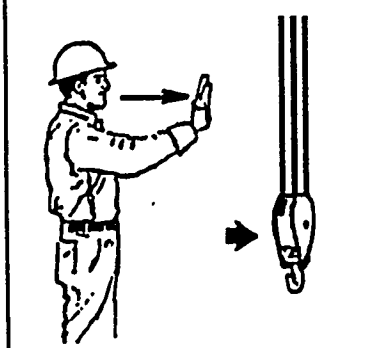
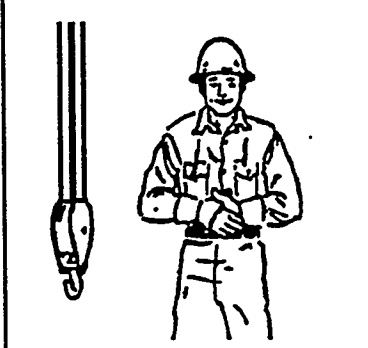
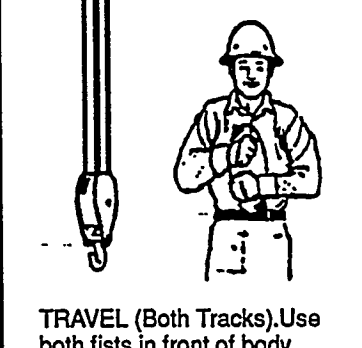
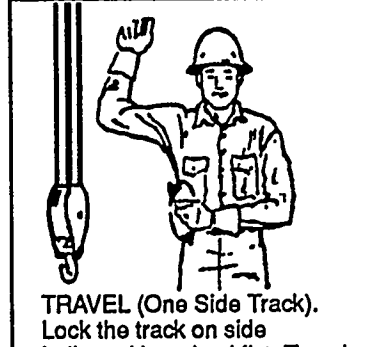
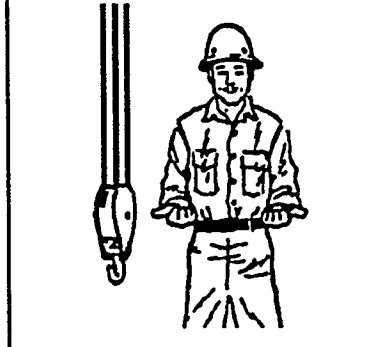
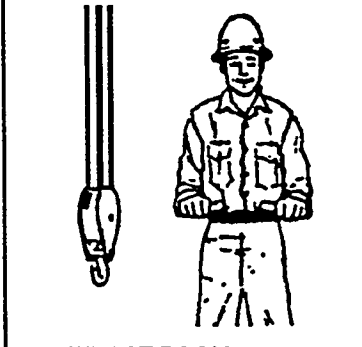
 <p>SWING. Arm extended point with finger in direction of swing of boom.</p>	 <p>STOP. Arm extended, palm down, move arm back and forth horizontally.</p>	 <p>EMERGENCY STOP. Both Arms extended, palms down, move arms back and forth horizontally.</p>
 <p>TRAVEL. Arm extended forward, hand open and slightly raised, make pushing motion in direction of travel.</p>	 <p>DOG EVERYTHING. Clasp hands in front of body.</p>	 <p>TRAVEL (Both Tracks). Use both fists in front of body, making a circular motion about each other, indicating direction of travel; forward or backward. (for land cranes only).</p>
 <p>TRAVEL (One Side Track). Lock the track on side indicated by raised fist. Travel opposite track indicated by circular motion of other fist, rotated vertically in front of body. (for land cranes only).</p>	 <p>EXTEND BOOM (Telescoping Booms). Both fists in front of body with thumbs pointing outward.</p>	 <p>RETRACT BOOM (Telescoping Booms). Both fists in front of body with thumbs pointing toward each other.</p>

LF90-0136

Figure 9-12a. Standard Hand Signals for Controlling Crane Operations (continued).

DRAFT

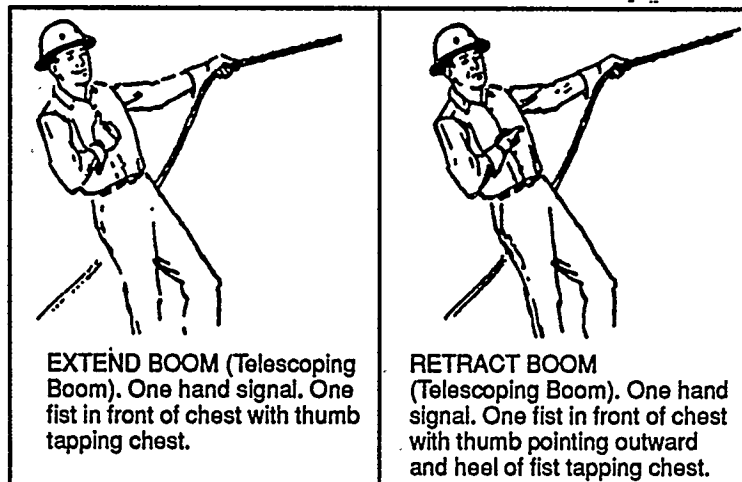
**DEPARTMENT OF
ENERGY
HOISTING & RIGGING
MANUAL****TITLE: CONSTRUCTION HOISTING & RIGGING
EQUIPMENT REQUIREMENTS****NUMBER: 9.0****REV: 00/91**

LF90-0137

Figure 9-12b. Standard Hand Signals for Controlling Crane Operations (continued).

DRAFT

**DEPARTMENT OF
ENERGY
HOISTING & RIGGING
MANUAL****TITLE: CONSTRUCTION HOISTING & RIGGING
EQUIPMENT REQUIREMENTS****NUMBER: 9.0****REV: 00/91**

- (2) Platforms shall be designed and constructed in accordance with the following:
- (a) The personnel platform shall be designed by a qualified person competent in structural design and all welding of the platform shall be performed by a qualified welder familiar with the weld grades, types and material specified in the design.
 - (b) The platform shall be limited to a capacity of six persons and shall be used only for employees, tools and materials to do the work and shall not be used to hoist materials or tools when not hoisting personnel.
 - (c) The platform shall have a minimum design factor of 5.
 - (d) The platform shall have a plate specifying the weight of the empty platform and the maximum number of persons and weight for which the platform is rated.
 - (e) The platform shall have standard railing as required by OSHA 29 CFR 1926.500(f). A grab rail shall be installed inside the entire perimeter of the personnel platform.
 - (f) The sides of the platform shall be enclosed from floor to mid-rail with solid construction or expanded metal having openings no greater than 1/2 in. (1.27 cm).
 - (g) If access doors are installed, they shall open only to the interior of the platform. Access doors shall be equipped with a device to restrain the door from inadvertent opening.
 - (h) The platform shall have overhead protection when there is an overhead hazard and employees shall use a body belt/harness and lanyard attached to the lower load block or overhaul ball or to a structural member within the personnel platform capable of supporting a fall impact for employees using the anchorage.
 - (i) The platform shall be easily identifiable by high visibility color or marking.
 - (j) Headroom shall be provided which allows employees to stand upright in the platform.
 - (k) Rough edges exposed to contact by employees shall be surfaced to prevent injury to employees.
 - (l) When being supported by a crane, the platform shall be attached to the hoist rope by a safety latched hook eliminating the hook throat opening, or an alloy steel anchor shackle with a bolt, nut and retaining pin may be used.
 - (m) All eyes in wire rope slings shall be fabricated with thimbles and all rigging accessories for attaching the personnel platform to hoist lines shall not be used for any other purpose when not hoisting personnel.
 - (n) When being supported by a forklift, the working platform shall be attached in such a manner that it cannot inadvertently slide or bounce off the tines.

DRAFT

**DEPARTMENT OF
ENERGY
HOISTING & RIGGING
MANUAL****TITLE: CONSTRUCTION HOISTING & RIGGING
EQUIPMENT REQUIREMENTS****NUMBER: 9.0****REV: 00/91**

- (3) At each job site, prior to hoisting employees on the personnel platform, and after any repair or modification, the platform and rigging shall be proof tested to 125% of the platform's rated capacity by holding it in a suspended position for five minutes with the test load evenly distributed on the platform. Upon completion of proof testing, a competent person shall inspect the platform/rigging and any deficiencies found shall be corrected, after which another proof test shall be conducted.
- (4) A meeting attended by the Qualified Operator, signalperson, persons to be lifted, and the construction management contractor safety personnel responsible for overall work-site safety shall be held prior to the trial lift to plan and review procedures to be followed. Procedures for entering and leaving the manlift platform or other device and the points at which persons will enter and leave the device shall be reviewed.
- (5) Prior to lifting personnel, the Qualified Operator and signalperson shall conduct a trial lift with the manlift platform loaded to at least the anticipated liftweight. Materials and tools to be used during the actual lift shall be loaded in the platform. The trial lift shall be repeated prior to hoisting personnel whenever the crane or forklift is moved and set up in a new location or returned to a previous location. A visual inspection of the crane/lifting machine, rigging and personnel lift platform shall be conducted in accordance with the requirements of Section 9.4 immediately after the trial lift and prior to lifting personnel. The trial lift may be done concurrently with the proof test specified in 9.5.2.a.(3) above.
- (6) The trial lift shall verify that all systems, controls and safety devices are activated and functioning properly; that no interferences exist and that all configurations necessary to reach those work locations will allow the operator to remain under the 50% limit of the lifting machine's rated capacity.
- (7) After the trial lift and just prior to hoisting personnel, the platform shall be hoisted a few inches and inspected to ensure that it is secure and properly balanced.
- (8) The employees being hoisted, moved, and/or positioned shall remain in continuous sight of, and in contact with, the operator or signalperson.
- (9) A signal person shall be utilized and voice communication between Qualified Operator, signalperson, and persons being lifted shall be maintained whenever voice-communication equipment is available.
- (10) Limiting devices shall be installed to prevent two-blocking or a system which deactivates the hoisting action before damage occurs in the event of a two-blocking situation (two block damage prevention feature) shall be utilized.
- (11) A boom angle indicator, readily visible to the operator, shall be provided on cranes/derricks with variable angle booms.
- (12) Prior to hoisting personnel from a mobile crane, an accurate determination of the load radius to be used during the lift shall be made. Cranes with telescoping booms shall be equipped with a device to indicate clearly to the operator, the boom's extended length.
- (13) The equipment shall be operated so that downward motion will be controlled lowering and load/boom hoist drum brakes, swing brakes, and locking devices such as pawls or dogs shall be engaged when an occupied personnel platform is in a stationary working position.

DRAFT

DEPARTMENT OF ENERGY HOISTING & RIGGING MANUAL	TITLE: CONSTRUCTION HOISTING & RIGGING EQUIPMENT REQUIREMENTS NUMBER: 9.0 REV: 00/91
---	---

- (14) When welding is done by an employee on the platform, welding-rod holders shall be protected from contact with metal components of the platform.
- (15) Employees working from a platform shall wear safety belts with lanyards attached, preferably above the hook or shackle, when being supported by overhead machines.
- (16) The Qualified Operator shall remain at the controls at all times when the platform is elevated.
- (17) Tag lines shall be used unless their use creates an unsafe condition.
- (18) When hoisting or lowering platforms, the speed shall not exceed 100 ft/min (0.51 m/s).
- (19) Mobile equipment shall not travel while personnel are on the platform.
- (20) Mobile cranes shall be uniformly level within one percent of level grade and located on firm footing. Cranes equipped with outriggers shall have them fully deployed.
- (21) The total weight of the loaded personnel platform and related rigging shall not exceed 50% of the rated capacity for the configuration of the crane or forklift.
- (22) Crane hoist lines shall be capable of lifting, without failure, at least seven times the maximum intended load, except that where rotation resistant rope is used, the lines shall be capable of supporting, without failure, at least 10 times the maximum intended load. The required design factor is achieved by taking the safety factor of 3.5 and applying the 50% derating which is required in (17) above.
- (23) Hoisting of personnel shall be promptly discontinued upon indication of dangerous weather conditions, i.e., lightning, heavy rain, high winds (>15 mph), etc.

9.5.3 Mobile Cranes/Boom Trucks

- a. Never use signs of tipping to determine if a load is within the cranes' capacity. Operating by the "seat of the pants" is an unacceptable practice.
- b. Know the rated capacity of the crane. A safe lift depends upon boom length, boom angle, and working radius. Follow these suggestions to avoid structural failure or tipping:
 - (1) Know the radius of the load. Remember that the radius is measured from center of rotation, not from the boom foot pins.
 - (2) Always operate within the rated capacity of your machine.
 - (3) Subtract the weight of hooks, blocks, and any other material-handling devices, i.e., slings, shackles, spreader bars, etc., from the gross capacity of the crane to determine if the load can be lifted safely.
 - (4) Load chart ratings are based on operating the machine on firm, level ground. Outriggers shall be fully extended and lowered so that all wheels are clear of the ground. Otherwise, "on rubber" load charts shall be used.
 - (5) Avoid rapid changes in velocity while hoisting, swinging or lowering the load; these can cause overloads when operating at or near the cranes' capacity.

DRAFT

DEPARTMENT OF ENERGY HOISTING & RIGGING MANUAL	TITLE: CONSTRUCTION HOISTING & RIGGING EQUIPMENT REQUIREMENTS NUMBER: 9.0 REV: 00/91
---	---

- (6) Do not lift large, heavy loads in strong winds. Wind loading can be critical depending on boom length, boom angle, bulkiness of the load, wind direction and wind velocity.

In the absence of crane manufacturer's instructions regarding maximum wind speeds for operation, 25–30 mph shall be used as the range to consider removal of the crane from service.

- c. Always use the shortest boom possible, and observe these precautions with any boom length:
- (1) Make only vertical lifts. Never pull the load sideways.
 - (2) Keep speed slow in lifting, lowering, and stopping loads.
 - (3) Do not let the load strike the boom or outriggers and never allow a crane boom to hit or touch any structure. Boom contact could dent, bow or slightly bend the lower boom chords and may cause a total boom collapse. Boom contact with any object shall require an engineering evaluation prior to putting the crane back in service. Damage of the crane during operation shall be repaired as per manufacturer's specifications using certified welders. A re-inspection and/or load test after repairs are complete and a re-certification by the construction management contractor at the sub-contractor's expense that the unit can return to service is required.
 - (4) Allow maximum clearance between the hook block and head sheaves.
 - (5) Keep near-capacity loads as close to the ground as possible.
- d. Rotate the crane slowly to avoid an outward swing of the load. Attach a tag-line to the load to control the swing.
- e. Keep the boom high enough to swing clear of cab when rotating the crane on truck-mounted units.
- f. Watch for boom "kickback". Never operate with the boom at a higher angle than shown on the capacity chart.
- g. Avoid "two-blocking", which is caused when the hook block collides with boom-point sheaves. Continuous pull on hoist ropes can break the ropes or might pull the boom over the cab. On hydraulically telescoping booms, be sure to play out the hoist rope when extending and reel in the hoist rope when retracting.
- h. Attaching the Load
- (1) The hoist rope shall be free from kinks or twists and shall not be wrapped around the load.
 - (2) The load shall be attached to the load-block hook by means of slings or other approved devices.
 - (3) Care shall be taken to make certain that the sling clears all obstacles.
- i. Moving the Load

DRAFT

**DEPARTMENT OF
ENERGY
HOISTING & RIGGING
MANUAL****TITLE: CONSTRUCTION HOISTING & RIGGING
EQUIPMENT REQUIREMENTS****NUMBER: 9.0****REV: 00/91**

- (1) Prior to moving the load, make certain that the load is well secured and properly balanced in the sling or lifting device before it is lifted more than a few inches.
- (2) Before starting to hoist, note the following conditions:
 - (a) Multiple-part lines shall not be twisted around each other.
 - (b) The hook shall be brought over the load in such a manner as to prevent swinging.
 - (c) If there is a slack rope condition, it should be determined that the rope is properly seated on the drum and in the sheaves.
- (3) Test stability before lifting heavy loads. Check outrigger footing. Lift load slightly off the ground and stop. Check the machine for movement and check to be sure the brakes hold with the load elevated. Never use machine stability to determine capacity. If there are any indications of tipping, the machine is already overloaded for that working radius.
- (4) Cranes shall not be used for side pulls, except when specifically authorized by a designated person who has determined that the stability of the crane is not thereby endangered and that various parts of the crane will not be overstressed.
- (5) The operator shall not hoist, lower, or travel while anyone is on the load or hook, except as noted in Section 9.5.1.s.
- (6) The operator shall not move loads over people.
- (7) The operator shall test the brakes each time a load approaching the rated capacity is handled by raising the load a few inches and applying the brakes.
- (8) Use power down when lowering loads. When lowering heavy loads, keep the hoist brakes as reserve. Use a safety pawl on the boom-hoist drum when not lowering.
- (9) The load shall not be lowered below the point where less than two full wraps of rope remain on the hoist drum.
- (10) The operator shall not leave his/her position at the controls while the load is suspended, unless required to do so by an approved emergency procedure.
- (11) Use extreme caution when working or traveling a crane near power lines. Except where the electrical distribution and transmission lines have been deenergized and visibly grounded at the point of work or where insulating barriers not a part of or an attachment to the crane have been erected to prevent physical contact with the lines, cranes shall operate so that no part of the crane or load enters into the "danger zone," shown in Figure 13.
 - (a) For lines rated 50 kV or below, minimum clearance between the lines and any part of the crane or load (including handling appendages) shall be 3.05 m (10 feet). For higher voltages, consult Table 2.
 - (b) Caution shall be exercised when working near overhead lines having long spans as they tend to move laterally or vertically due to the wind which would cause them to breach the safety zone.

DRAFT

DEPARTMENT OF ENERGY HOISTING & RIGGING MANUAL	TITLE: CONSTRUCTION HOISTING & RIGGING EQUIPMENT REQUIREMENTS	REV: 00/91
	NUMBER: 9.0	

Table 9-2. Safe working distance from power lines

a. When operating near high voltage power lines:

<u>Normal Voltage (phase to phase)</u>	<u>Minimum Required Clearance</u>
to 50 kV	10 ft (3.05m)
Over 50 to 200 kV	15 ft (4.60 m)
Over 200 to 350 kV	20 ft (6.10 m)
Over 350 to 500 kV	25 ft (7.62 m)
Over 500 to 750 kV	35 ft (10.67 m)
Over 750 to 1000 kV	45 ft (13.72 m)

b. While in transit with no load and boom or mast lowered:

<u>Normal Voltage (phase to phase)</u>	<u>Minimum Required Clearance</u>
to 0.75 kV	4 ft (1.22 m)
Over 0.75 to 50 kV	6 ft (1.33 m)
Over 50 to 345 kV	10 ft (3.05 m)
Over 345 to 750 kV	16 ft (4.87 m)
Over 750 to 1000 kV	20 ft (6.10 m)

(c) In transit with no load, and boom lowered, the clearance shall be as specified in Table 2.

(d) A qualified signalperson shall be assigned to observe the clearance and give warning before approaching the limits specified in Table 2.

(12) If cage-type boom guards, insulating links, or proximity-warning devices are used on cranes, such devices shall not be a substitute for the requirements of Paragraph 9.5.2.i.(11), even if such devices are required by law or regulation. In view of the complex, invisible, and lethal nature of the electrical hazard involved, and to lessen the potential of false security, limitation of such devices, if used, shall be understood by operating personnel and tested in the manner and in the intervals prescribed by the manufacturer of the device. Compliance with Paragraph 9.5.2.i.(11) is the recommended practice of this standard in determining proximity of the crane, including load, to electric power lines.

(13) Before the commencement of operations near electrical conductors, the person responsible for the job shall notify the owners or their authorized representatives, and provide them with all pertinent information and request their cooperation.

DRAFT

DEPARTMENT OF ENERGY HOISTING & RIGGING MANUAL	TITLE: CONSTRUCTION HOISTING & RIGGING EQUIPMENT REQUIREMENTS NUMBER: 9.0 REV: 00/91
---	--

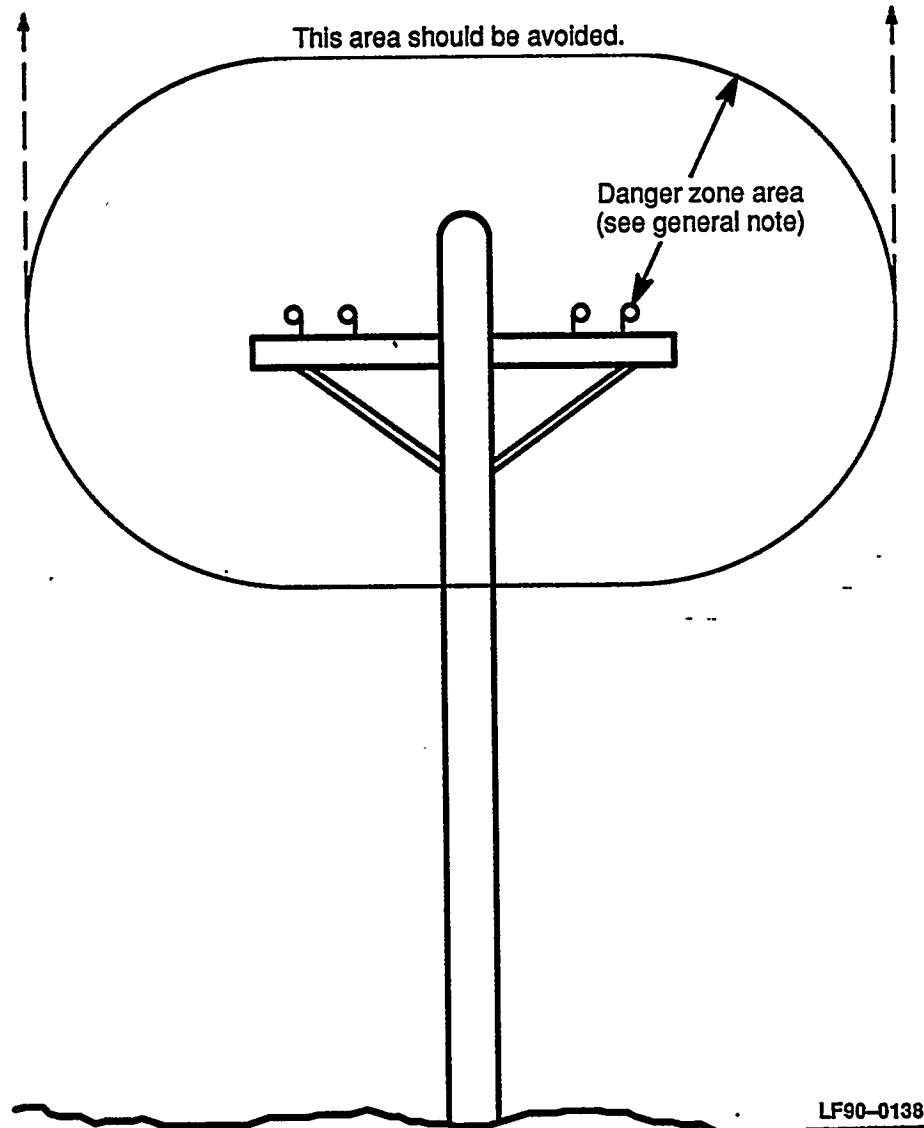

Figure 9-13. Danger Zone for Cranes and Lifted Loads Operating Near Electrical Transmission Lines.

DRAFT

DEPARTMENT OF ENERGY HOISTING & RIGGING MANUAL	TITLE: CONSTRUCTION HOISTING & RIGGING EQUIPMENT REQUIREMENTS NUMBER: 9.0 REV: 00/91
---	---

- (14) Any overhead conductor shall be considered to be energized unless and until the person owning such conductor or the electrical utility authorities verify that it is not energized.
 - (15) The Electric Power Marketing agencies in DOE may deviate from the requirements of Table 2 providing the work is done according to line management-approved procedures which are not in conflict with statutory regulations, or approved variances from these regulations.
 - (16) Durable signs shall be installed at the operator's station and on the outside of the crane, warning that electrocution or serious bodily injury may occur unless a minimum clearance of 10 feet (3.05 m) is maintained between the crane or the load being handled and energized power lines. Greater clearances are required because of higher voltage as stated in Table 2. These signs shall be revised but not removed when local jurisdiction requires greater clearances.
 - (17) Prior to work near transmitter towers where an electrical charge can be induced in the equipment or materials being handled, the transmitter shall be deenergized or tests shall be made to determine if electrical charge is induced on the crane.
- j. When traveling the machine:
- (1) Secure the boom and hook block.
 - (2) Check bridges before crossing; make sure they will support the weight of the machine.
 - (3) Check river depths when fording.
 - (4) Check clearances under overpasses, overhead lines, or any overhead obstruction. When side clearances are tight, post a lookout, and be sure there is clearance for tail swing.
 - (5) When traveling with a load, snub the load to prevent swaying if possible. Never travel with near-capacity loads.
 - (6) Never travel a rubber-tired unit with a load over the side.
 - (7) In soft going, always move with the load behind; this helps to raise the leading end of the tracks and makes traveling safer.
 - (8) Always set swing brakes when the unit is idle or holding loads for a period of time, especially on slopes. If swinging during travel is necessary, engage the swing-jaw clutch before releasing brakes.
 - (9) Never back up until everyone is clear of the machine and use a signalman when backup alarms are not provided.
 - (10) Avoid tipping by never backing the crane while carrying a maximum load.
 - (11) For long moves, position the boom in direction of travel.
 - (12) Block treads when moving uphill to prevent downhill movement before shifting steering clutches.

DRAFT

DEPARTMENT OF ENERGY HOISTING & RIGGING MANUAL	TITLE: CONSTRUCTION HOISTING & RIGGING EQUIPMENT REQUIREMENTS NUMBER: 9.0 REV: 00/91
---	---

- (13) Lock the turntable before traveling on a highway. Use a house lock or swing brake, and lower boom into the rack to prevent swing.
- (14) When loading machine on the trailer, always use ramp; if a ramp is not available, use blocking to build one.
- k. The operator shall be familiar with the equipment and its proper care. If adjustments or repairs are necessary, the operator shall promptly report this to the appropriate level of management.
- l. All controls shall be tested by the operator at the start of a new shift. If any controls fail to operate properly, they shall be adjusted or repaired before operations are begun.
- m. Block under boom before disassembling. Never stand on or under the boom during this work.
- n. Before disconnecting oil lines, if machine has hydraulic controls, be sure to place boom on the ground or in the boom rest; then move the pedals and control levers to equalize pressures within the cylinders. Always release any air supercharge on the hydraulic reservoir and shut off the engine (or declutch pumps) before disconnecting oil lines.
- o. Do not reach into hydraulic-boom holes unless the sections are securely anchored together.
- p. High-Consequence Lifts:
 - (1) The operating organization shall appoint one person to be in charge of the entire lifting operation (PIC). This person shall meet the definitions of appointed, designated, and qualified, as set forth in Section 9.2.
 - (2) The PIC shall be a Qualified Rigging Specialist, or shall be assisted by a Qualified Rigging Specialist, experienced in using hoisting and rigging equipment of the type to be used; preparing and reviewing drawings, procedures, and equipment assignments; and supervising the job.
 - (3) The PIC shall assure that a work plan is prepared covering the entire lifting operation. Consideration of the lift history of the crane shall affect the plan, which shall also include, but is not limited to, sling angles and sizes; inspection and test-certification periods; load configuration; the presence of hazardous materials; and the requirement for a load-indicating device. The plan must be reviewed and approved by the cognizant Safety organization.
 - (4) When the weight of the lift is within 10% of the rated capacity, and equipment of greater capacity is not available, the PIC shall review, in detail, the positioning and rigging of the load with the persons who will carry out the lift. The effect of ground conditions, wind and weather on the stability of the equipment, and the effect of rotational and translational speeds shall be considered in giving instructions to equipment operators.
 - (5) Hoisting shall be carefully observed while tension is being applied and a check made to determine any tendency to swing or sway, and any tendency of slings to slip or change position. Sling positions shall be adjusted or additional supports or restraints shall be added as necessary before continuing the lift. Procedural approval of changes to sling position, supports, and restraints shall be obtained from the appointed person before they are made.

DRAFT

DEPARTMENT OF ENERGY HOISTING & RIGGING MANUAL	TITLE: CONSTRUCTION HOISTING & RIGGING EQUIPMENT REQUIREMENTS NUMBER: 9.0 REV: 00/91
---	---

- (6) Only Qualified Professional Operators may be assigned to operate the lifting equipment. Signalers to operators shall be Qualified Riggers.
- (7) Generalized procedures may be submitted for the handling of these loads, except when detailed procedures are specified. Individual procedures for several similar items are not required, unless specified. Procedures shall include identification of the item or class of items to be moved, the type of equipment and rigging accessories to be used and their rated capacity, any special instructions to operators, and provision for verification by the authorized person that the lift or move has been satisfactorily completed. The PIC shall certify that good rigging practices, precautions, and safety measures shall be employed, that equipment operators are qualified and have been properly instructed, and the equipment is adequate for the loads involved and in good operating condition.

Load tests will not be conducted in location such that the lift meets the definition of a High-Consequence or Special-High-Consequence Lift in Section 9.2.

q. Special-High-Consequence Lifts:

- (1) In addition to those items required above for High-Consequence Lifts, the following shall apply:
 - (a) Identification of each piece of operating equipment to be used in the move by type, rated capacity, and, for other than permanently installed equipment, the equipment serial number or other identifying number. (If the specific piece of non-permanent equipment has not been identified at the time of procedure specification, the number shall be included in the job instructions prepared by the appointed person.)
 - (b) Identification of slings, lifting bars, and other major rigging accessories or assemblies, by serial number and weight. (If the specific items have not been identified at the time of procedure preparation, they shall be identified in the job instructions prepared by the appointed person.)
 - (c) A list of all nonserialized rigging accessories and materials required in the move or lift, identified by type, capacity, and weight.
 - (d) Identification of the item to be moved, its weight, dimensions, center of gravity (as determined by the method of SAE J874 or estimated from drawings or engineering analysis), and the total hook load.
 - (e) Rigging sketches showing all lifting points, load vectors, sling angles, accessories, methods of attachment, boom angles, crane orientations, and other factors affecting the capacity of equipment and accessories used in the move, together with notation of limitations to be applied on any allowable orientation of the operating equipment or rigging accessories to be used.
 - (f) Approximate and maximum hoisting speeds.
 - (g) Instructions to be given to equipment operators, including boom and swing angles at each step of the move, sequence of equipment moves, and coordination with moves of other equipment involved; translational speeds, direction, and distances, load weight, center of gravity, and other pertinent data.

DRAFT

DEPARTMENT OF ENERGY HOISTING & RIGGING MANUAL	TITLE: CONSTRUCTION HOISTING & RIGGING EQUIPMENT REQUIREMENTS NUMBER: 9.0 REV: 00/91
---	---

- (h) Identification of persons who will have field responsibility for the move or lift and for monitoring it.
- (i) Requirements for specific tests to be made before, during, and after the move or lift, including load test for Special-High-Consequence Loads or practice lift.
- (j) Surveillance procedures, including check points, instruments, and indicators, that will be used to ensure that the move proceeds according to plan and the rated capacity of the equipment has not been exceeded.
- (k) Provision for verification by the appointed person or his/her designee of satisfactory completion of each step of the procedure as it occurs.

9.5.4 Forklift Trucks

- a. Know the rated capacity of the forklift and always operate within that capacity. Since the load rating for forklifts may be based on stability, or hydraulic/structural competence, the rated capacity shall not be exceeded in operational application. Signs of tipping shall never be used to determine if a load is within the forklifts' capacity.
- b. Before operation of electric powered machines, check location of the battery plug for quick disconnection in case of a short circuit.
- c. Battery recharging and maintenance shall take place in designated areas where smoking, sparks, or open flames are prohibited. Eye protection, rubber gloves and rubber aprons shall be worn. Whenever battery maintenance is performed, any area of the body affected by contact with battery electrolyte shall be flushed with water immediately and all acid spills must be cleaned up at once.
- d. Fueling of internal combustion-powered lift trucks shall take place in designated areas. The vehicle engine must be turned off and smoking, sparks, or open flames shall be prohibited.
- e. Handling LPG fuel presents a unique hazard. Therefore, to avoid injury while refueling with LPG fuel, the refueling procedure in the operator's manual for the vehicle must be followed precisely.
- f. The operation of internal combustion-powered lift trucks in confined spaces shall be prohibited unless special precautions are followed to preclude the build up of carbon monoxide gas above prescribed levels.
- g. Only qualified operators shall be permitted to operate forklift trucks. No one shall operate the equipment other than the person to whom it is assigned.
- h. Report and/or correct any apparent mechanical deficiencies prior to operating the forklift truck.
- i. Operating the unit:
 - (1) Before handling, assure that stacks and loads are stable. Block and lash them if necessary.
 - (2) Riders are prohibited on powered industrial trucks, unless the truck is specifically built with passenger seating.

DRAFT

DEPARTMENT OF ENERGY HOISTING & RIGGING MANUAL	TITLE: CONSTRUCTION HOISTING & RIGGING EQUIPMENT REQUIREMENTS NUMBER: 9.0 REV: 00/91
---	--

- (3) To avoid personal injury, keep head, arms, and legs inside the operator's area of the machine.
- (4) Operate at safe speeds: in-plant buildings—5 mph; in-plant roads 15 mph maximum. Go slow around curves.
- (5) Stop and sound the horn at all intersections and doorways. Watch out for blind corners.
- (6) Use low gear or slowest-speed control when descending ramps.
- (7) Always spread the forks to suit the load width.
- (8) Do not daydream while operating.
- (9) Never allow anyone to get under the elevated forks of the lift truck.
- (10) Lift, lower, and carry loads with the mast vertical or tilted back; never forward.
- (11) Avoid reaching through the mast for any purpose.
- (12) Lower and raise the load slowly, only while the vehicle is stopped. Make smooth gradual stops.
- (13) Use special care when high-tiering. Return the lift to a vertical position before lowering load.
- (14) Avoid sudden stops and starts.
- (15) Watch overhead clearance. If in doubt, measure.
- (16) Never travel with forks raised to unnecessary heights. Approximately 4 to 6 inches above floor level is adequate.
- (17) Drive slowly over railroad tracks and rough surfaces. Cross tracks at an angle whenever possible.
- (18) Consider both the truck and load weight when operating in railcars, semitrailers, elevators, etc.
- (19) When loading trucks or trailers, see that the wheels are chocked and the brakes set. Operate in front end of the semitrailer only if the tractor is attached, or adequate trailer (railroad) jacks are in place.
- (20) Inspect floors on trucks, boxcars, unfamiliar ramps, or platforms before start of operation.
- (21) Make certain that bridge plates into trucks or freight cars are sufficiently wide, strong, and secure. Check them frequently.
- (22) Watch rear-end swing and keep clear of the edge of loading docks.
- (23) Face or look in the direction of travel at all times. Travel in reverse when view of forward travel is obstructed by the load, except when ascending an incline.

DRAFT

DEPARTMENT OF ENERGY HOISTING & RIGGING MANUAL	TITLE: CONSTRUCTION HOISTING & RIGGING EQUIPMENT REQUIREMENTS NUMBER: 9.0 REV: 00/91
---	--

- (24) When descending a ramp or incline with a load, always travel in reverse and when ascending, travel forward.
- (25) Avoid turning around on ramps or inclines.
- (26) Fork trucks should not be used as tow trucks. They are built for lifting only, unless a towing hitch is supplied by the manufacturer. Use tow bars rather than wire rope for towing.
- (27) Never butt loads with forks or rear end of truck. Never lift with one tine without an engineering analysis and approval.
- (28) Avoid leaving the forklift unattended with the motor running or power supply connected in the case of electrically powered equipment. The load engaging means shall be on the floor, the emergency brake activated and the ignition key removed.
- (29) Return the machine at the end of shift to its assigned parking place, ignition shall be turned off, brakes set, forks lowered and flat on the floor, shift in neutral position and the key removed.
- (30) Do not use as a personnel elevator, unless an approved safety platform securely attached to the forks is utilized (see Section 9.5.1.s).
- (31) When alighting from a truck, step down—do not jump.
- (32) Report all accidents promptly to your Supervisor.
- (33) The final responsibility for the handling of a truck remains with the driver. Use guides and signalers as much as possible. Standard signals shall be as specified in the latest edition of applicable ANSI B-30 codes and standards. Signals most commonly used are shown in Figure 9-14.

j. Moving the Load

- (1) The nature of the terrain, or surface upon which the truck is to operate, is a very important factor in the stability of lift-truck systems. The designated person shall assure that a proper truck has been selected to operate on the surface available. In general, small, three-wheeled trucks are to be operated on smooth, hard surfaces only, and are not suitable for outdoor work.
- (2) The designated person shall assure that the load is well secured and properly balanced before it is lifted.
- (3) During hoisting, care should be taken that:
 - (a) There is no sudden acceleration of the load.
 - (b) The load does not contact any obstruction.

k. High-Consequence Lifts:

- (1) The operating organization shall appoint one person in charge (PIC) of the entire lifting operation. This person shall meet the definitions of appointed, designated, and qualified, as set forth in Section 9.2.

**DEPARTMENT OF
ENERGY
HOISTING & RIGGING
MANUAL**

**TITLE: CONSTRUCTION HOISTING & RIGGING
EQUIPMENT REQUIREMENTS**

NUMBER: 9.0

REV: 00/91

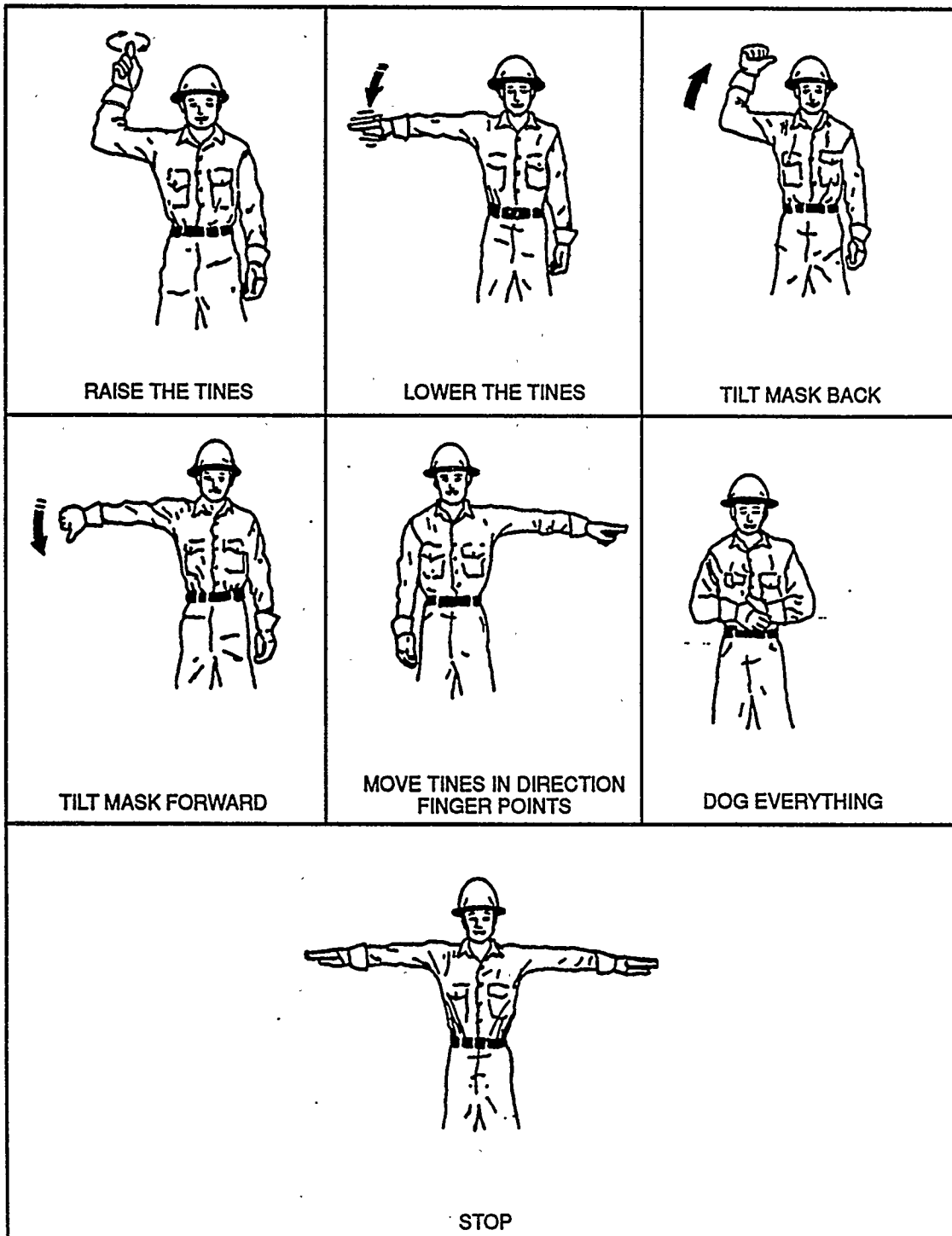

LF90-0139

Figure 9-14. Standard Hand Signals for Controlling Forklift Operators.

DRAFT

DEPARTMENT OF ENERGY HOISTING & RIGGING MANUAL	TITLE: CONSTRUCTION HOISTING & RIGGING EQUIPMENT REQUIREMENTS NUMBER: 9.0 REV: 00/91
---	---

- (2) The PIC shall assure that a work plan is prepared covering the entire lifting operation. Consideration of the lift history of the truck shall affect the plan, which shall also include, but is not limited to, inspection and test-certification periods, load configuration, and the presence of hazardous materials. The plan must be reviewed and approved by the cognizant construction management contractors Safety organization.
 - (3) When the weight of the lift is within 10% of the special-rated capacity, and equipment of greater capacity is not available, the PIC shall review, in detail, the handling of the load with the person who will carry out the lift. The effect of ground conditions, wind and weather on the stability of the equipment, and the effect of rotational and translational speeds shall be considered in giving instructions to equipment operators.
 - (4) When two or more trucks are required to lift or handle a load, one qualified specialist shall be assigned who shall analyze the operation, instruct all personnel in the proper positioning and rigging of the load and use of the equipment, and direct the operation of all equipment.
 - (5) Load tests will not be conducted in locations such that they meet the definitions of High-Consequence or Special-High-Consequence Lifts in Section 9.2.
 - (6) The PIC shall be a Qualified Rigging Specialist, or shall be assisted by a Qualified Rigging Specialist, experienced in using hoisting and rigging equipment of the type to be used; preparing and reviewing drawings, procedures, and equipment assignments; and supervising the job.
 - (7) Only Qualified Professional Operators may be assigned to operate the lifting equipment. Signalers to operators shall be Qualified Riggers.
 - (8) Generalized procedures may be submitted for the handling of these loads, except when detailed procedures are specified. Individual procedures for several similar items are not required unless specified. Procedures shall include identification of the item or class of items to be moved, the type of equipment and rigging accessories to be used and their rated capacity, any special instructions for operation, and provision for verification by the authorized person that the lift or move has been satisfactorily completed. The PIC shall certify that good rigging practices, precautions, and safety measures will be employed; the equipment operators are qualified and have been properly instructed; and that equipment is adequate for the loads involved and is in good operating condition.
1. **Special-High-Consequence Lift:**
- (1) In addition to those items required above for high consequence lifts, the following shall apply:
 - (a) Identification of each piece of operating equipment to be used in the move by type, rated capacity, and, for other than permanently installed equipment, the equipment serial number or other identifying number. (If the specific piece of nonpermanent equipment has not been identified at the time of procedure specification, the number shall be included in the job instructions prepared by the appointed person.)
 - (b) Identification of accessories or assemblies by serial number and weight. (If the specific items have not been identified at the time of procedure preparation, they shall be identified in the job instructions prepared by the appointed person.)

DRAFT

DEPARTMENT OF ENERGY HOISTING & RIGGING MANUAL	TITLE: CONSTRUCTION HOISTING & RIGGING EQUIPMENT REQUIREMENTS NUMBER: 9.0 REV: 00/91
---	---

- (c) A list of all nonserialized rigging accessories and materials required in the move or lift, identified by type, capacity, and weight.
- (d) Identification of the item to be moved, its weight, dimensions, and center of gravity.
- (e) Sketches showing special attachments, lifting fixtures, accessories, methods of attachment, and other factors affecting the capacity of equipment and accessories used in the move, together with notation of limitations to be applied on any allowable orientation of the operating equipment or rigging accessories to be used.
- (f) Instructions to be given to equipment operators, including sequence of equipment moves and coordinations with moves of other equipment involved; translational speeds, directions, and distances, load weight, center of gravity, and other pertinent data.
- (g) Identification of persons who will have field responsibility for the move or lift and for monitoring it.
- (h) Requirements for specific tests to be made before, during, and after the move or lift, including a load test for Special-High-Consequences Loads or a practice lift.
- (i) Surveillance procedures, including check points, instruments, and indicators, that will be used to ensure that the move is proceeding according to plan and the rated capacity of the equipment has not been exceeded.
- (j) Provision for verification by the PIC, or his/her designee, of the satisfactory completion of each step of the procedure as it occurs.

9.5.5 Written Procedure Requirements

- a. For High-Consequence Lifts the PIC shall assure that a work plan is prepared covering the entire lifting operation. Consideration of the lift history of the crane shall affect the plan, which shall also include, but is not limited to, sling angles and sizes; inspection and test-certification periods; load configuration; the presence of hazardous materials; and the requirement for a load-indicating device. The plan must be reviewed and approved by the cognizant Safety organization.
- b. In addition to those items required above for high-consequence lifts, the work plan for special-high-consequence lifts shall include, as a minimum, the following:
 - (1) Identification of each piece of operating equipment to be used in the move by type, rated and special-rated capacity, and, for other than permanently installed equipment, the equipment serial number or other identifying number. (If the specific piece of nonpermanent equipment has not been identified at the time of procedure specification, the number shall be included in the job instructions prepared by the appointed person.)
 - (2) Identification of slings, lifting bars, and other major rigging accessories or assemblies, by serial number and weight. (If the specific items have not been identified at the time of procedure preparation, they shall be identified in the job instructions prepared by the appointed person.)

DRAFT

DEPARTMENT OF ENERGY HOISTING & RIGGING MANUAL	TITLE: CONSTRUCTION HOISTING & RIGGING EQUIPMENT REQUIREMENTS NUMBER: 9.0 REV: 00/91
---	--

- (3) A list of all nonserialized rigging accessories and materials required in the move or lift, identified by type, capacity, and weight.
- (4) Identification of the item to be moved, its weight, dimensions, and center of gravity (as determined by the method of SAE J874 or estimated from drawings or engineering analysis), and the total hook load.
- (5) Rigging sketches showing all lifting points, load vectors, sling angles, accessories, methods of attachment, boom angles, crane orientations, and other factors affecting the capacity of equipment and accessories used in the move, together with notation of limitations to be applied on any allowable orientation of the operating equipment or rigging accessories to be used.
- (6) Approximate and maximum hoist and winching speeds.
- (7) Instructions to be given to equipment operators, including boom and swing angles at each step of the move, sequence of equipment moves, and coordination with moves of other equipment involved; translational speeds, direction, and distances, load weight, center of gravity, and other pertinent data.
- (8) Identification of persons who will have field responsibility for the move or lift and for monitoring it.
- (9) Requirements for specific tests to be made before, during, and after the move or lift, including load test for Special-High-Consequence Loads or practice lift.
- (10) Surveillance procedures, including check points, instruments, and indicators, that will be used to ensure that the move proceeds according to plan and the special-rated capacity of the equipment has not been exceeded.
- (11) Provision for verification by the appointed person or his/her designee of satisfactory completion of each step of the procedure as it occurs.

DEPARTMENT OF ENERGY HOISTING & RIGGING MANUAL	TITLE: REFERENCES NUMBER: 10.0 REV: 00/91
---	--

ISSUE NO. 6

10.0 REFERENCES

10.1 American Institute of Steel Construction

AISC Specifications for the design, fabrication, and erection of structural steel for buildings.

10.2 American Iron and Steel Institute

AISI Standards for Type-302 or Type-304 stainless steel.

10.3 American National Standards Institute

10.3.1 ANSI A10.28-1983, Work Platforms Suspended From Cranes or Derricks.

10.3.2 ANSI A12.1-1975, Floor and Wall Openings, Railings and TOE Boards.

10.3.3 ANSI/ASME B30.2-1990, Overhead and Gantry Cranes (Top running Bridge, Single or Multiple Girder, Top Running Trolley Hoist).

10.3.4 ANSI/ASME B30.5-1989, Mobile & Locomotive Cranes.

5a - 1990

10.3.5 ANSI/ASME B30.6-1990, Derricks.

10.3.6 ANSI/ASME B30.7-1989, Base-Mounted Drum Hoists.

10.3.7 ANSI/ASME B30.9-1990, Slings.

10.3.8 ANSI/ASME B30.10-1987, Hooks.

10a - 1990

10.3.9 ANSI/ASME B30.11-1988, Monorail Systems and Underhung Cranes.

11a - 1989

11b - 1990

10.3.10 ANSI/ASME B30.12-1986, Handling Loads Suspended from Rotorcraft.

12a - 1987

12b - 1988

12c - 1990

10.3.11 ANSI/ASME B30.14-1985, Side Boom Tractors.

14a - 1986

14b - 1987

14c - 1989

14d - 1990

DRAFT

**DEPARTMENT OF
ENERGY
HOISTING & RIGGING
MANUAL****TITLE: REFERENCES****NUMBER: 10.0****REV: 00/91****10.3.12 ANSI/ASME B30.16–1987, Overhead Hoists (Underhung).**

16a – 1989

16b – 1990

10.3.13 ANSI/ASME B30.17–1985, Overhead and Gantry Cranes (Top Running Bridge, Single Girder, Underhung Hoist).

17a– 1987

17b – 1988

17c – 1989

17d – 1990

10.3.14 ANSI/ASME B30.20–1985, Below-The-Hook Lifting Devices.

20a – 1987

20b – 1988

20c – 1989

20d – 1990

10.3.15 ANSI/ASME B30.21–1989 Manually Lever Operated Hoists.**10.3.16 ANSI/ASME B30.22–1987, Articulating Boom Cranes.**

22a – 1988

10.3.17 ANSI/ASME B56.1–1988 Safety Standard for Powered Industrial Trucks—Low Lift and High Lift Trucks.**10.3.18 ANSI/ASME B56.5–1988, Guided Industrial Vehicles.****10.3.19 ANSI/ASME B56.6–1987, Rough Terrain Fork Lift Trucks.**

6a – 1988

10.3.20 ANSI/ASME B56.7, Industrial Crane Trucks.

Special Notice 6–88

10.3.21 ANSI/ASME B56.11.4–1988, Forks and Fork Carriers for Powered Industrial Fork Lift Trucks, Hook Type.**10.3.22 ANSI/ASME HST–1M–1989, Performance Standard for Electric Chain Hoists.****10.3.23 ANSI/ASME HST–2M–1989, Performance Standard for Hand Chain Manually Operated Chain Hoists.****10.3.24 ANSI/ASME HST–3M–1985, Performance Standard for Manually Lever Operated Chain Hoists.****10.3.25 ANSI/ASME HST–4M–1985, Performance Standard for Electric Wire Rope Hoists.**

DRAFT

DEPARTMENT OF ENERGY HOISTING & RIGGING MANUAL	TITLE: REFERENCES	
	NUMBER: 10.0	REV: 00/91

- 10.3.26 ANSI/ASME HST-5M-1985, Performance Standard for Air Chain Hoists.
- 10.3.27 ANSI/ASME HST-6M-1986, Performance Standard for Air Wire Rope Hoists.
- 10.3.28 ANSI MH 27.1-1981, Specifications for Underhung Cranes and Monorail Systems.
- 10.3.29 ANSI N14.6-1986, Standard for Special Lifting Devices for Shipping Containers Weighing 10,000 Pounds (4500 kg) or More for Nuclear Materials.
- 10.3.30 ANSI/ASME NOG-1-1989, Rules for Construction of Overhead and Gantry Cranes (Top Running Bridge, Multiple Girder).
- 1a - 1985
- 10.3.31 ANSI/ASME NQA-1-1989, Quality Assurance Program Requirements for Nuclear Facilities.
- 10.4 American Society for Non-Destructive Testing**
- Recommended Practice No. ASNT-TC-1A.
- 10.5 American Society for Testing Materials**
- ASTM Specification A391, Specification for Alloy Steel Chain.
- 10.6 Crane Manufacturers' Association of America**
- 10.6.1 CMAA No. 70-1983, Specification for Electric Overhead Traveling Cranes.
- 10.6.2 CMAA No. 74-1974, Specification for Top Running and Under Running, Single Girder, Electric Overhead Traveling Cranes.
- 10.7 Department of Energy**
- 10.7.1 DOE Order 5480.4.
- 10.8 Department of Transportation**
- 49 CFR 391.41, Physical Qualification for Drivers.
- 10.9 National Fire Protection Association**
- 10.9.1 ANSI/NFPA 505-1987, Powered Industrial Trucks, Type Designation and Area Use.
- 10.10 Power Crane and Shovel Association
- 10.10.1 PCSA-1, Mobile Power Crane and Excavator Standards.
- 10.10.2 PCSA-2, Mobile Hydraulic Crane Standards.
- 10.11 Society of Automotive Engineers**

DRAFT

DEPARTMENT OF ENERGY HOISTING & RIGGING MANUAL	TITLE: REFERENCES	REV: 00/91
	NUMBER: 10.0	

10.11.1 SAE J376-85, Load-Indicating Devices in Lifting Crane Service.

10.11.2 SAE J765-1980, Crane Load Stability Test Code.

10.11.3 SAE J874-1986, Center of Gravity Test Code.

10.11.4 SAE J987-1985, Crane Structure, Method of Test.

10.12 Underwriters' Laboratories

10.12.1 UL 558-1984, Internal-Combustion-Engine-Powered Industrial Trucks.

10.12.2 UL 583-1986, Electric-Battery-Powered Industrial Trucks.