

KAPL-P-000126
(K98170)

LESSONS LEARNED ON CLOSED CAVITY THERMOPHOTOVOLTAIC SYSTEM
EFFICIENCY MEASUREMENTS

CONF-981055--

C.K. Gethers, C. T. Ballinger, D. M. DePoy

October 1998

DISTRIBUTION OF THIS DOCUMENT IS UNLIMITED *ph.*

MASTER

NOTICE

This report was prepared as an account of work sponsored by the United States Government. Neither the United States, nor the United States Department of Energy, nor any of their employees, nor any of their contractors, subcontractors, or their employees, makes any warranty, express or implied, or assumes any legal liability or responsibility for the accuracy, completeness or usefulness of any information, apparatus, product or process disclosed, or represents that its use would not infringe privately owned rights.

KAPL ATOMIC POWER LABORATORY

SCHENECTADY, NEW YORK 12601

Operated for the U. S. Department of Energy
by KAPL, Inc. a Lockheed Martin company

DISCLAIMER

This report was prepared as an account of work sponsored by an agency of the United States Government. Neither the United States Government nor any agency thereof, nor any of their employees, makes any warranty, express or implied, or assumes any legal liability or responsibility for the accuracy, completeness, or usefulness of any information, apparatus, product, or process disclosed, or represents that its use would not infringe privately owned rights. Reference herein to any specific commercial product, process, or service by trade name, trademark, manufacturer, or otherwise does not necessarily constitute or imply its endorsement, recommendation, or favoring by the United States Government or any agency thereof. The views and opinions of authors expressed herein do not necessarily state or reflect those of the United States Government or any agency thereof.

DISCLAIMER

Portions of this document may be illegible in electronic image products. Images are produced from the best available original document.

Lessons Learned on Closed Cavity TPV System Efficiency Measurements

C. K. Gethers, C. T. Ballinger, and D.M. DePoy

Lockheed Martin Corporation, Schenectady, NY

Abstract: Previous efficiency measurements [1] have highlighted that to accurately measure and predict thermophotovoltaic (TPV) integrated cell or array efficiencies, a thorough understanding of the system is required. This includes knowledge of intrinsic diode and filter characteristics, radiative surface properties of all materials used within the cavity, and an intimate knowledge of the radiator / photon source. As a result of these and other lessons learned, the cavity test fixture used in earlier experiments was redesigned. To reduce radiator temperature gradients, the radiator was oversized and thickened, cavity walls were eliminated, the diode heat sink and shielding material were separated, and the cold side was redesigned to incorporate a steady state heat absorbed measurement technique. This redesigned test fixture provides an isothermal radiator and significantly enhances calorimetry capabilities. This newly designed cavity test fixture, in conjunction with the Monte Carlo Photon Transport code RACER-X, was used to improve and demonstrate the understanding of "in-cavity" TPV diode / module system efficiency testing. A single TPV diode was tested in this new fixture and yielded good agreement between measurements and predictions.

INTRODUCTION

Years of thermophotovoltaic (TPV) system experience have shown that TPV efficiency tests in prototypical environments often have results that are contrary to intuition. Small gaps, thin busbars and other macroscopically small features can have an unexpected impact on efficiency. TPV efficiency, η , is measured by dividing the diode / module maximum output power (P_{OUT}) by its total absorbed heat (P_{ABS}), illustrated by equation 1.

$$\eta = \frac{P_{OUT}}{P_{ABS}} = \frac{V_{OC} I_{SC} f f}{\dot{m} C_p \Delta T} \quad (1)$$

where,

P_{OUT} = maximum power output by the array,

P_{ABS} = the array's total absorbed radiative heat,

V_{OC} = diode / module open circuit voltage,

I_{sc} = diode / module short circuit current,

ff = diode / module fill factor,

\dot{m} = mass flow rate of the coolant,

C_p = specific heat of the coolant, and

ΔT = coolant temperature rise between inlet and outlet of the array.

TPV diode / module efficiency is primarily dependent upon first order effects such as diode quality and the type and quality of spectral control used. However, engineering factors also affect efficiency, including:

- Geometry (i.e., gaps and grids lines)
- Radiator temperature, profile and emissivity
- Cavity spectral properties
- Networking losses (i.e., cell mismatching and series resistance)
- Fabrication flaws (i.e., solder and flux residue)

These factors, as well as others, need to be thoroughly understood, if predictable TPV efficiency measurements are to be made. Once a demonstrated understanding of TPV cavity system efficiency measurements is made (via agreement between measurements and predictions), then prototypical and efficient TPV systems can be engineered.

Previous TPV efficiency measurements agreed well with predictions to within 10%. However, the efficiency predictions for the individual components (P_{out} and P_{abs}) were approximately 20% lower than measurements. Possible reasons for this large discrepancy were initially attributed to uncertainties in radiator temperature, profile and emissivity, spectral quantum efficiency, filter reflectivity, and various other modelling assumptions. Based upon these results, a concerted effort was made to more thoroughly understand the fundamentals of TPV diode system efficiency measurements in a closed cavity geometry. This was accomplished by simplifying the test articles used, redesigning the experiment and refining predictive capabilities.

Two computer codes were developed and refined to model in-cavity TPV system efficiency measurements. The first, TPVCalc, assumes an infinite parallel plate arrangement, subdivides the infrared spectrum into several bands, and then numerically integrates over the spectrum to provide diode performance predictions [2]. However in some cases, a one dimensional (1-D) code such as this, may not be able to model the desired effect; but rather account for it through the application of an engineering factor applied to the final calculated result. The second model, a 3-D Monte Carlo Photon Transport code called RACER-X, tracks photons from birth at the radiation source until

they either escape or are absorbed; and is more geometrically flexible than TPVCalc [1]. A 3-D analysis capability such as RACER-X, could possibly provide more reliable predictive analysis.

This paper discusses the lessons learned from this testing effort and the steps taken to improve our understanding of in-cavity TPV system efficiency measurements.

ORIGINAL EXPERIMENTAL SETUP

Reference 1 briefly describes the test fixture and procedure used to obtain the original TPV in-cavity system efficiency measurements (Figure 1). The test rig consisted of an aluminum heater cavity and diode / module heat sink. The heater cavity was simply a small hollowed out aluminum block designed to provide a blackbody photon source for diode / module illumination. A window was machined in the base of the block to provide a path for the radiant heat to the target positioned beneath it. A small electrically resistive heater was mounted to the lid of the heater cavity and used to radiatively heat the blackbody radiator. The polished internal walls of the cavity reduced the power required to radiatively heat the radiator material. And, the polished window edge helped the test fixture to simulate an infinitely large radiator to the target positioned centrally beneath it.

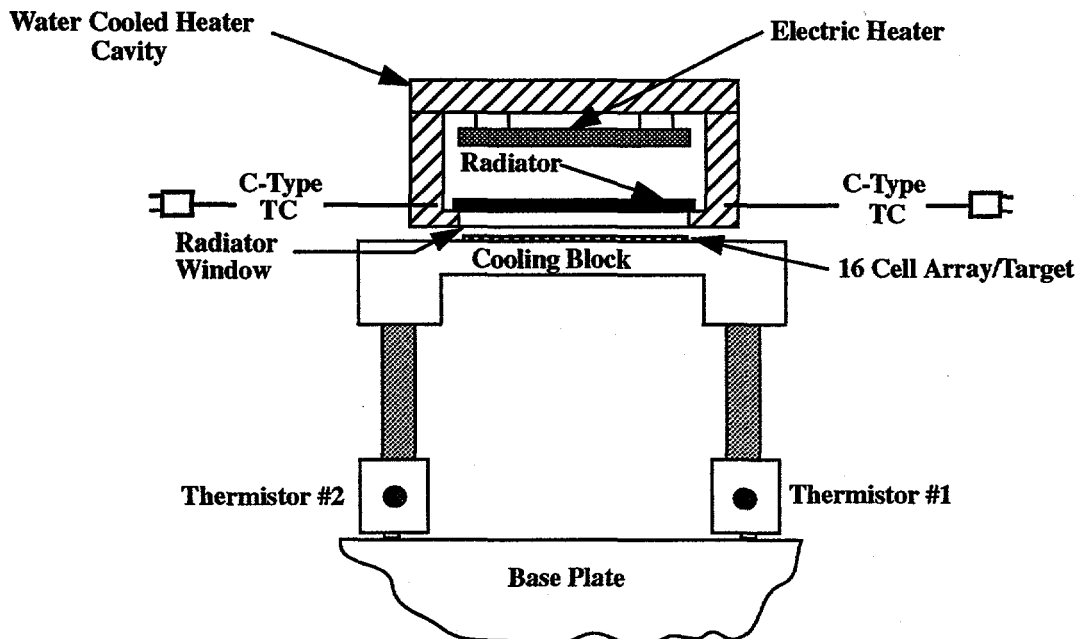

Figure 1. Schematic representation of the previous experimental setup

The 50.80 mm² poco graphite radiator was approximately 2.032 mm thick and rested atop the window. The radiator was thermally isolated from the aluminum structure via small diameter ceramic pins. This arrangement locates the radiator approximately 7.62 mm above the surface of the cold side heat sink and reduces conductive gradients caused by direct contact with the water cooled structure. Two - 1.02 mm diameter thermocouple holes were drilled 6.35 mm deep on two sides of the radiator, so that the average radiator temperature could be measured during testing.

The diode / module heat sink used to assist in measuring the absorbed heat was a simple "U" shaped aluminum cooling block. The cooling block was fabricated with internal flow channels to ensure even cooling across the face of the block. Diodes or targets to be tested were attached to the cooling block via a two part silicon based epoxy material. To address parasitic absorption concerns, the perimeter of the target was typically shielded with gold foil. The cooling block and target could then be centered beneath the heater cavity's radiator window for testing.

All experiments were conducted under steady state, high vacuum conditions. Once the fixture was assembled and properly aligned in the vacuum chamber, testing was initiated. This consisted of raising radiator temperature to a desired level and allowing the system to equilibrate. At steady state, the electrical performance of the diode / module was measured with a Tektronix 370A Curve Tracer. The complete diode / module IV curve was collected and the values of interest (i.e., I_{sc} , V_{oc} , ff and P_{out}) were extracted from the curve via an in-house computer program.

The diode / module absorbed heat was measured by monitoring the temperature rise and coolant flow rate. Absorbed heat measurements were always taken with the module open circuited to ensure that the heat was transferred to the coolant, and was not lost to joule heating of an external load. Once obtained, this data was ratioed with the electrical data to determine efficiency.

LESSONS LEARNED

Initial efficiency tests resulted in good agreement between previous efficiency measurements and predictions. However, a significant variation was noted between the measured and predicted maximum output power and total absorbed heat (~20%). Since both the numerator and denominator were high by approximately the same amount, the comparison of measured and predicted efficiency was not significantly affected. To more thoroughly understand these results, the test apparatus and computer models used were critically evaluated. This evaluation was performed by simplifying the experiment, mod-

ifying the computer codes to more accurately model the experiment, and by conducting various sensitivity predictions using RACER-X. In this set of experiments, small square silicon wafers were used as cold side targets. Since silicon has a relatively flat spectral profile and no surface features, this type of test represents the simplest case possible. Analysis of the test was conducted using RACER-X. This analysis reinforced the importance of understanding geometry effects, explicitly knowing the radiator's temperature, profile and the spectral properties of all in-cavity materials.

For instance, one analysis showed how the combination of the gap between the heater cavity and cold side heat sink and the imperfectly reflecting cavity window walls results in an illumination profile on the target. Even with a flat temperature profile on the radiator, a nonuniform photon flux distribution at the target level still exist. This effect is illustrated in Figure 2. This Figure shows the normalized distribution of above bandgap energy deposition on a sixteen cell module; notice the nonuniformity. If an array were fabricated of perfectly matched cells, this illumination profile would degrade the performance of the array and lower the efficiency. To circumvent this effect, the cavity window walls must be either eliminated or be perfectly reflecting. This nonuniform illumination effect is further amplified by the known parabolic profile of the radiator used in this experiment. This uneven temperature distribution across the radiator, therefore, makes this cavity test fixture ill-suited for efficiency testing of multi-cell arrays.

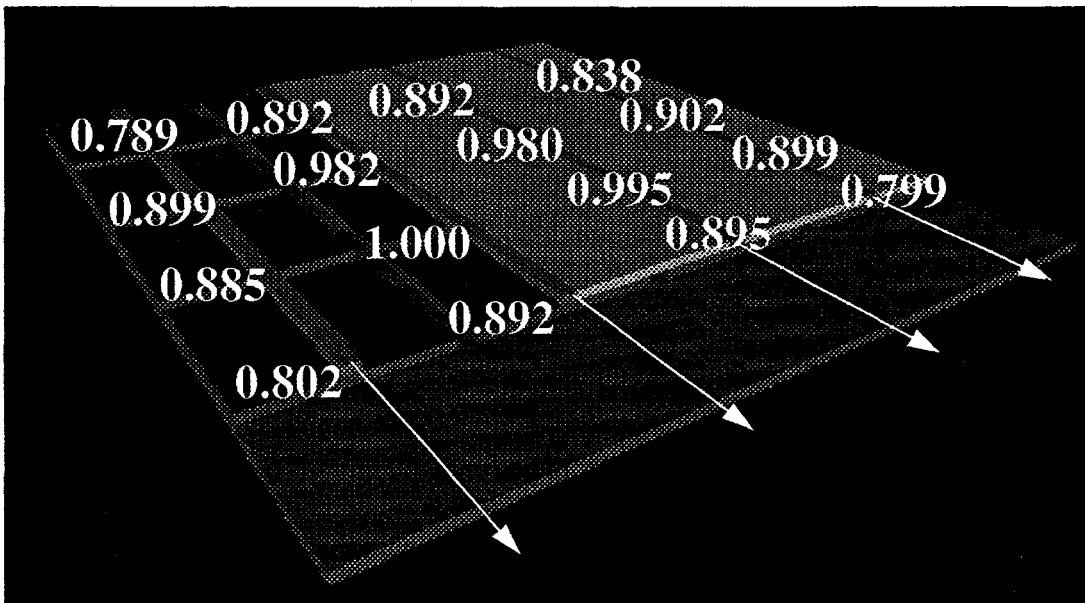

Figure 2. Computer model illustrating the normalized above bandgap energy deposition for a module exposed to an isothermal radiator.

Figure 3 shows good agreement between the computational results for the old cavity test at two different temperatures (using the silicon targets) and measurements. This agreement came, in part, after carefully modeling the "as-built" geometry of the cavity, the uneven temperature profile across the radiator, and the actual room temperature radiator emissivity.

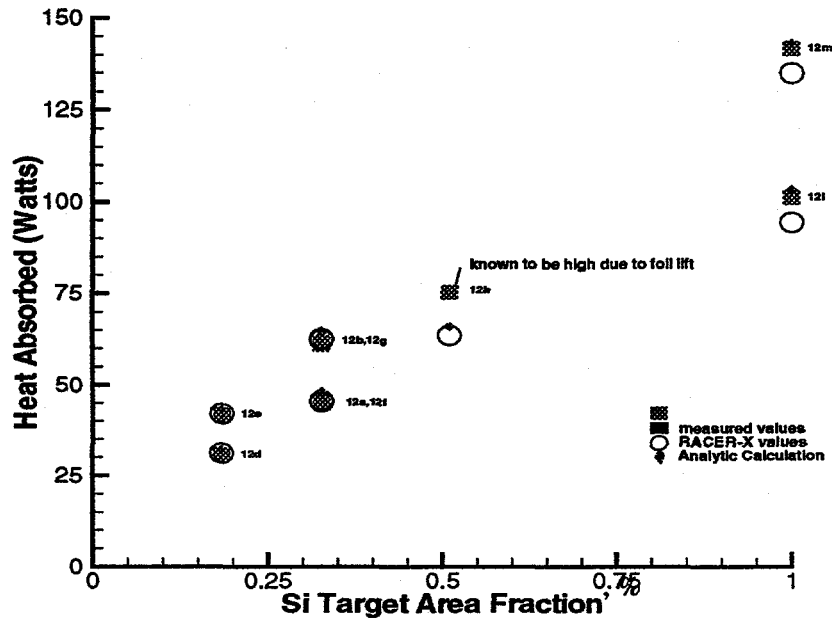

Figure 3. Comparison of Silicon experimental data with predictions.

Even though the computer model was carefully constructed, final adjustments to the results were made by varying the reflectivity of the gold foil used to shield the heat sink from the previously modelled 98% to 95%; both of which are reasonable for this material. As this data suggests, small variations in the reflectivities of in-cavity materials can significantly change the predicted results. Accurate verification of the gold foil's reflectivity after testing is needed but currently not possible. This is due to the complexity of the measurement. The gold foil surface is largely specular, however, a purely specular reflectivity measurement cannot be made due to the wrinkled condition of the foil after testing. A measurement of this type would only give an idea as to what the material's reflectivity is. Thus, a better shielding procedure or explicit knowledge of the shielding material is required to ensure more accurate predictions.

However, it should also be noted that accurate modelling of the radiator's temperature profile is difficult at best. Unmodelled variations in the profile and / or inaccuracies in the measurement of radiator temperature or other factors could also lead to similar agreement between measurements and predictions. Other noteworthy spectral effects that cannot presently be measured include: (1) radiator spectral emissivity at temperature, and (2) the effect of directly depositing filter material over grid lines, and (3) fabrication induced anomalies. These effects may have a significant impact on the model's predictions. However, they are extremely difficult, if not impossible, to quantify. These effects are also not explicitly accounted for in the computer models.

Many of the lessons learned mentioned seem to be apparent observations to the skilled experimentalist. Small geometries and / or other minor effects are often dismissed as being trivial and having no significant impact on the measured or predicted results. However, careful consideration should be given to them, as they may cause greater than expected deviations.

To summarize the findings of this testing effort, the careful evaluation of the test fixture and computer model sensitivity studies revealed the following lessons learned:

- Cavity geometry effects must be understood and modeled appropriately
- The radiator's temperature, profile, and emissivity must be explicitly known
- Reflectivity characteristics of all cavity components must be explicitly modeled
- Angle of incidence effects have to be modeled accurately
- Minor fabrication flaws must be accounted for as they can impact measurements and predictions (i.e., take nothing for granted)

It is also worthy to note that a 1-D type of analysis could not perform most of the geometric sensitivity studies conducted in this experimental evaluation. A 3-D analysis technique such as RACER-X, however, can handle them easily.

IMPROVED EXPERIMENTAL SETUP

Based upon previous testing experience, the agreement achieved in this simplified testing effort and RACER-X sensitivity analysis results, the test fixture used in this experiment was redesigned. It now contains a water cooled heater cavity and a diode / module heat sink and shield (Figure 4a). The water cooled heater cavity was designed to provide a blackbody photon source.

The heater cavity is a water cooled aluminum block with a 63.5 mm^2 window machined

in its bottom. This window acts as a view port for a 60.325 mm^2 pcco graphite radiator. The radiator is 31.75 mm thick and, within the cavity, rests atop 12.70 mm thick alumina insulation. The insulation also has a window machined in it and is thermally decoupled from the aluminum cavity via ceramic spacers. Ceramic locator pins allow for the central location of the radiator between the two windows. Alumina insulation is attached to the cavity's lid along with two electrically resistive heaters. The heaters are used to heat the pcco graphite radiator, and can be independently controlled to reduce or induce thermal gradients at the radiator surface.

Sixteen - 1.02 mm diameter thermocouple holes are located approximately 0.508 mm from the surface (four on a side) and are at various depths. This type of thermocouple arrangement enables a mapping of the radiator's thermal profile which can be provided as input into the photon transport code RACER-X. Using this fixture, the diode heat sink can be located as close as 0.127 mm away from the radiator surface, thus ensuring a 1:1 view factor.

Radiator temperature is typically measured with C and K type 1.02 mm diameter thermocouples. Occasionally, to calibrate these thermocouples, a calibrated high-temperature single-color sapphire pyrometer is used. To accommodate the sapphire pyrometer in the radiator, one of the thermocouple holes was bored out to 1.65 mm in diameter. Since all pyrometers suffer from measurement inaccuracies due to emissivity uncertainties at temperature, the thermocouple hole into which the pyrometer was inserted was made to emulate a blackbody cavity. As detailed in reference 3, a cavity's emissivity can be altered by varying its length to diameter ratio. For this experiment the ratio of these two values was approximately 8. The pyrometer highlighted a delta of 40F and 20F between the C and K type thermocouples, respectively.

The fixture's array / diode heat sink and shield are two separate water cooled structures (Figure 4b). These two fixtures were separated to reduce measurement uncertainties associated with the posited change in the optical properties of the shielding material after application to the array heat sink. The diode / array heat sink consists of a round water cooled copper block that has a square copper pedestal extending from its top surface. The pedestal is 12 cm long and has three evenly spaced (placed 5 cm apart) 1.02 mm diameter thermocouple holes along its center. Thermocouples of equivalent diameter were soldered into the holes to improve thermal contact between them. The pedestal's cross sectional area was dependent upon the cross sectional area of the target. The cold side was mounted onto a three axis positioner to accurately position the target beneath the thermal shield.

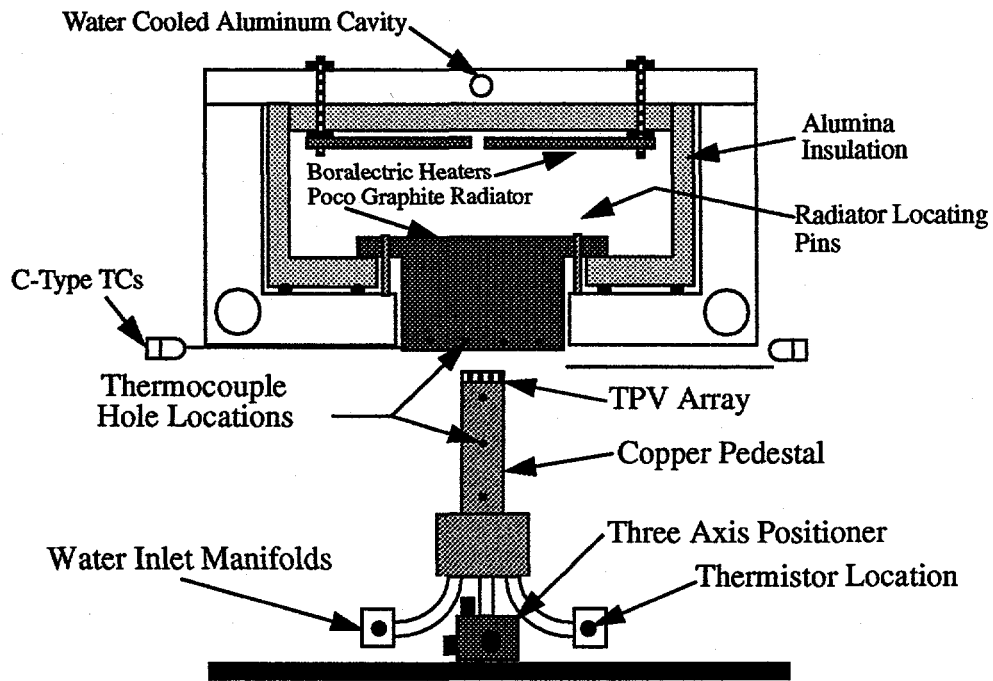

Figure 4a. Schematic of the redesigned cavity test fixture (thermal shield not shown).

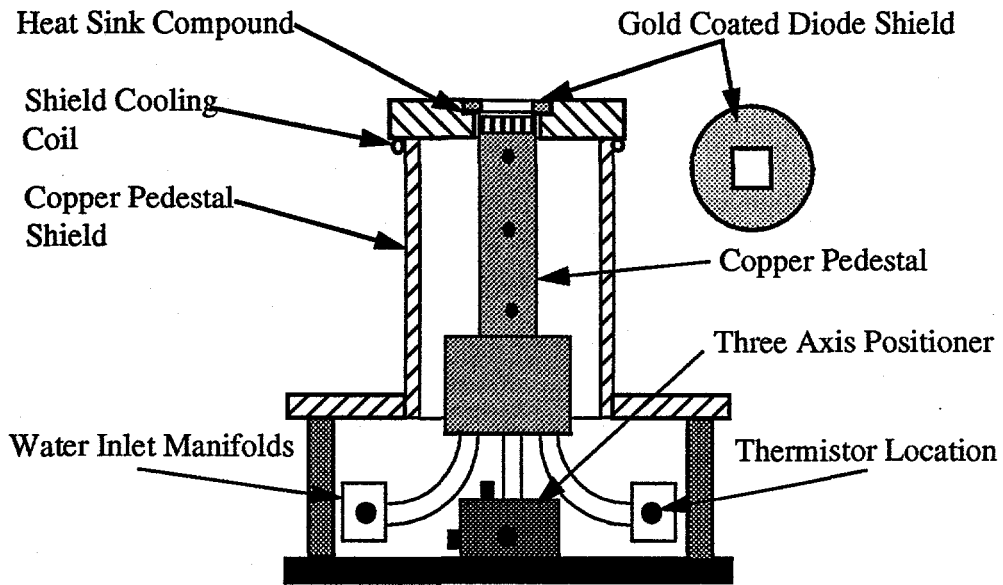

Figure 4b. Schematic of the diode / target thermal shield.

This unique fixture allows for two independent thermal measurements. Since the structure is water cooled and testing is conducted under steady state conditions, the diode or target's absorbed heat can be measured by monitoring the temperature rise and coolant flow rate illustrated by equation 2.

$$P_{abs} = Q = KA \frac{\Delta T}{\Delta x} \quad (2)$$

where,

K = the thermal conductivity of the copper pedestal,

A = the cross sectional area of the copper pedestal,

ΔT = the temperature rise of the copper pedestal, and

Δx = the distance between the temperature difference measurements.

This technique has proven to be extremely effective and accurately measures the absorbed heat of small cross sectional areas. Un-shuttered in-cavity single diode TPV system efficiency measurements can now be easily made. These types of measurements were previously extremely complicated due to cell cooling issues.

Another benefit of this technique is that the diode or module attached to the pedestal can also be used to perform in situ system calibrations. Due to the need for large temperature rise measurements, this type of calibration technique was not possible with the old test fixture. The copper pedestal technique also significantly enhances absorbed heat absorption measuring capabilities. Whereas, based upon calibration data, the accuracy of this measurement was limited to $\sim\pm 5\%$, the improved copper pedestal technique renders accuracies of $\sim\pm 1\%$.

EXPERIMENTAL RESULTS

The redesigned experimental test fixture was used to perform in-cavity TPV system efficiency measurements. Prior to diode testing, the fixture was evaluated for illumination uniformity. Three diodes were characterized, individually wired, and mounted onto a special rotating fixture ~ 2.54 mm beneath the radiator. The short circuit current of each diode was measured and indicated that the illumination profile of the radiator was uniform.

Scoping tests with the redesigned test fixture were performed with a two part diode / module shield. The shield was thermally isolated from the copper pedestal via a small perimeter gap that was ~ 0.356 mm wide on average (Figure 5). A RACER-X analysis was conducted of this configuration and highlighted the fact that a significant amount of

heat strikes the edges of the target and copper pedestal; manifesting itself as parasitic absorption. Figure 6 shows the predicted sensitivity of the heat absorption to the gap spacing around the target. Notice that small increases in the gap, substantially increase the heat absorbed. This situation was corrected by redesigning the shield as a single unit slightly smaller than the target.

Following these results, a single TPV diode efficiency test was conducted. Typically test temperatures ranged from ~870C-1200C. A poor-performing Indium Gallium Arsenide (InGaAs) 0.55eV diode with a direct deposited interference filter was used. A comparison of the experimental results and predictions are presented in Table 1. The data in this Table show good agreement with both RACER-X and TPVCalc predictions.

Table 1: Comparison of Single Diode Measured Data With Predictions.

	Measured Results	RACER-X Results	Difference (%)	TPVCalc Results	Difference (%)
Absorbed Heat Flux, Watts/cm ²	5.90	6.00	-2.30	5.28	10.50
V _{oc} , V	0.296	N/A	N/A	0.283	4.4
I _{sc} , A	2.191	2.41	-9.9	2.228	-4.0
ff, %	57.38	N/A	N/A	60.2	-4.9
P _{out} , W	0.372	N/A	N/A	0.389	-4.5
η, %	6.30	N/A	N/A	7.36	-16.8

The diode's absorbed heat and electrical properties (i.e., I_{sc}, P_{out}, etc.) agree to within ~10%. However, the TPVCalc predicted efficiency is ~16% higher than the measured value. This is due to the under prediction of absorbed heat and the over prediction of short circuit current. It should be noted that both codes over predict the diode's current. Typically, modelling predictions are lower than measurements.

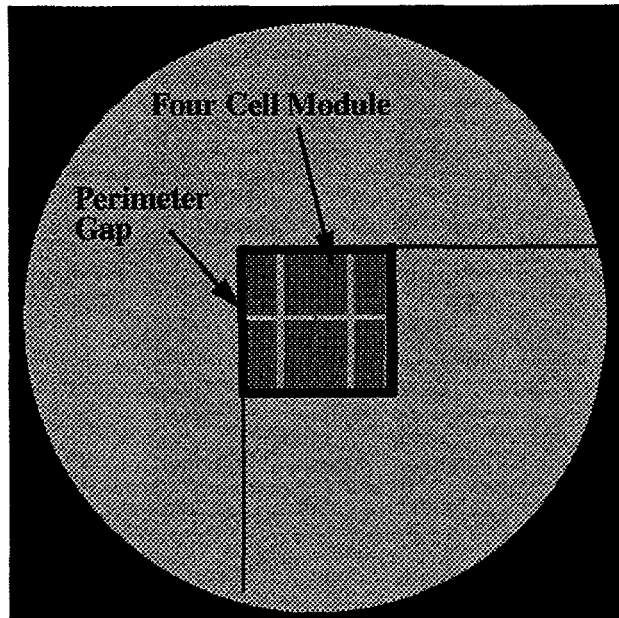

Figure 5. Computer model of the top view of the two part shield design.

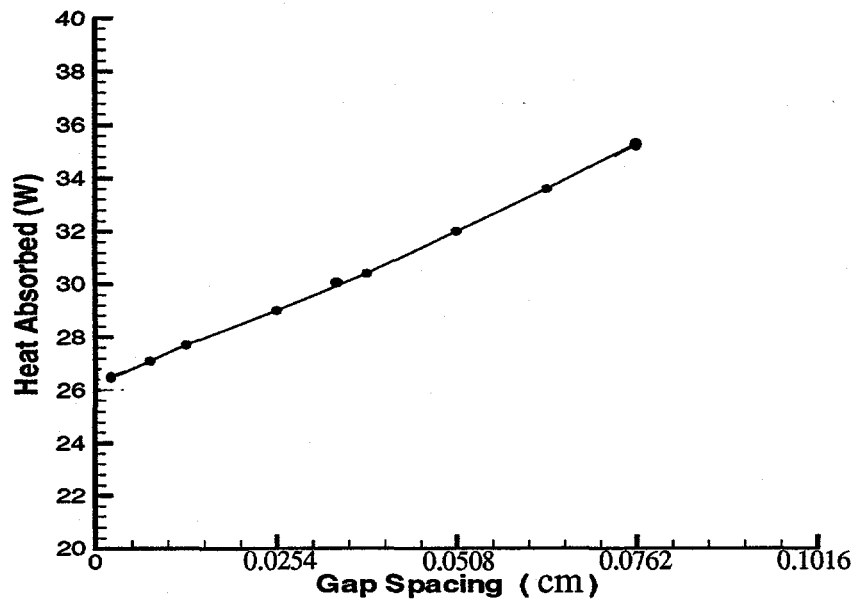

Figure 6. RACER-X perimeter gap sensitivity study results.

A possible cause for this discrepancy may be related to the size of the shield. The redesigned one piece shield has a $\sim 1\text{cm}^2$ opening machined in it (Figure 4b). The diode tested in this experiment was $\sim 1.08\text{ cm}^2$. Therefore, accurate positioning of the diode beneath the shield was critical. The diode was positioned beneath the shield via a three axis positioner (Figure 4b).

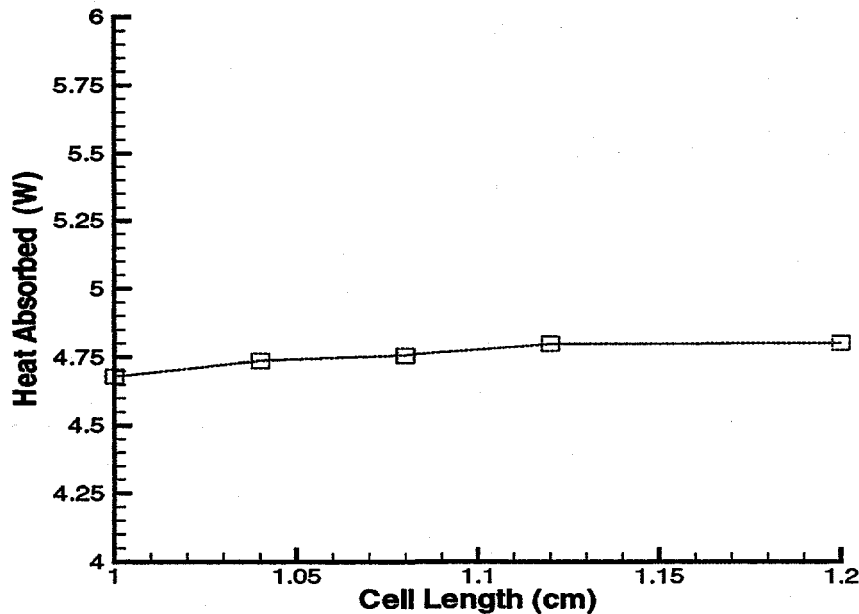

Figure 7. Heat absorbed as a function of target size.

However, accurate positioning of the target beneath the shield relies heavily on the operator. Therefore, it is possible that the active area was slightly shaded by the shield causing a reduction in current, and an increase in heat absorption. After analysis of these results, a RACER-X sensitivity study was performed to determine the effects of reducing the size of the thermal shield (Figure 7). This study showed that having a shield smaller than the active area causes a negligible rise in absorbed heat.

CONCLUSIONS

In conclusion, extensive research experience has shown that obtaining predictable in-cavity system efficiency measurements are not intuitive. Even though TPV efficiency is greatly dependent upon first order effects such as diode and spectral control quality, many other engineering factors can significantly impact expected results. This research

effort has shown that test fixture design plays a key role in obtaining predictable results. The geometry of the fixture (i.e., cavity walls and gaps) may create an undesirable thermal profile within the cavity, thus directly impacting predictive capabilities and the general performance of the system.

Other analysis has shown that the spectral properties of all in-cavity materials can also significantly impact efficiency. Spectral properties, as difficult as they are to measure, must be accurately known and modeled as they can account for a significant portion of parasitic heat absorption. Also, small gaps, thin busbars and other macroscopic features can also impact efficiency. All of the factors mentioned need to be explicitly understood if predictable in-cavity TPV system efficiency measurements are to be made.

ACKNOWLEDGEMENTS

We would like to acknowledge the insight and assistance of Dr. Greg Charache, Dr. Paul Baldasaro, Dr. Josef Parrington and Michael Postlethwait for testing support and analysis. We would also like to thank Dr. Lee Danielson, Steve Berger, Joe Nehrbaauer and Nick Brooks for their valuable insight, suggestions and help.

REFERENCES

1. Gethers, C.K., Ballinger, C.T., Postlethwait, M.A., DePoy, D.M., and Baldasaro, P.B., "TPV Efficiency Predictions and Measurements for a Closed Cavity Geometry", The Third NREL Thermophotovoltaic Conference, AIP Conference Proceeding, 471, 1997.
2. Charache, G. W. et. al., "Measurement of Conversion Efficiency of Thermophotovoltaic Devices", Proc. of the 2nd NREL Conference on TPV Generation of Electricity, 351, 1995.
3. Modest, M. F., Radiative Heat Transfer, McGraw-Hill, New York, 1993.