

These drawings may be handed out to students as references
after completion of the design exercises

Print at 8½" x 11" or similar

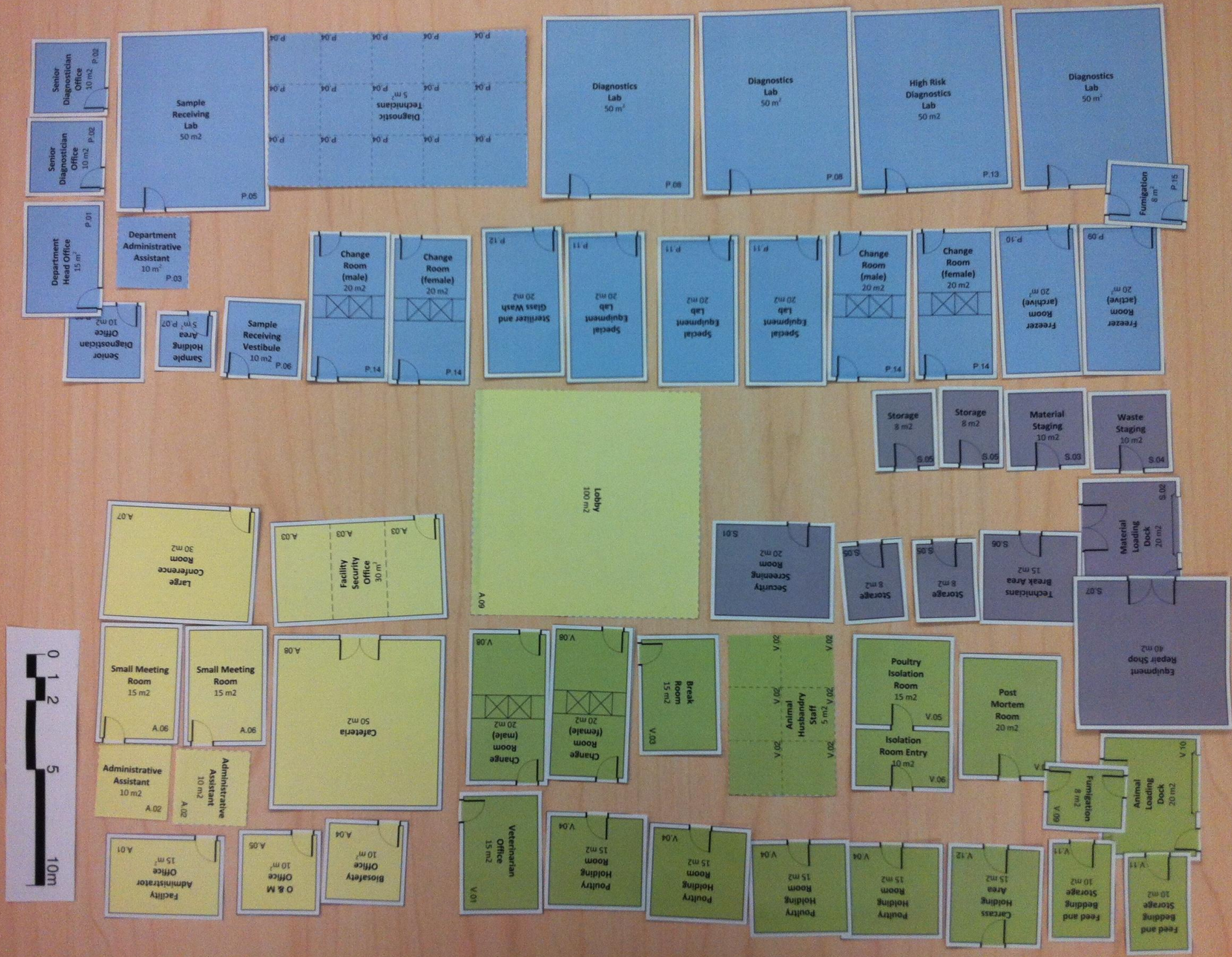

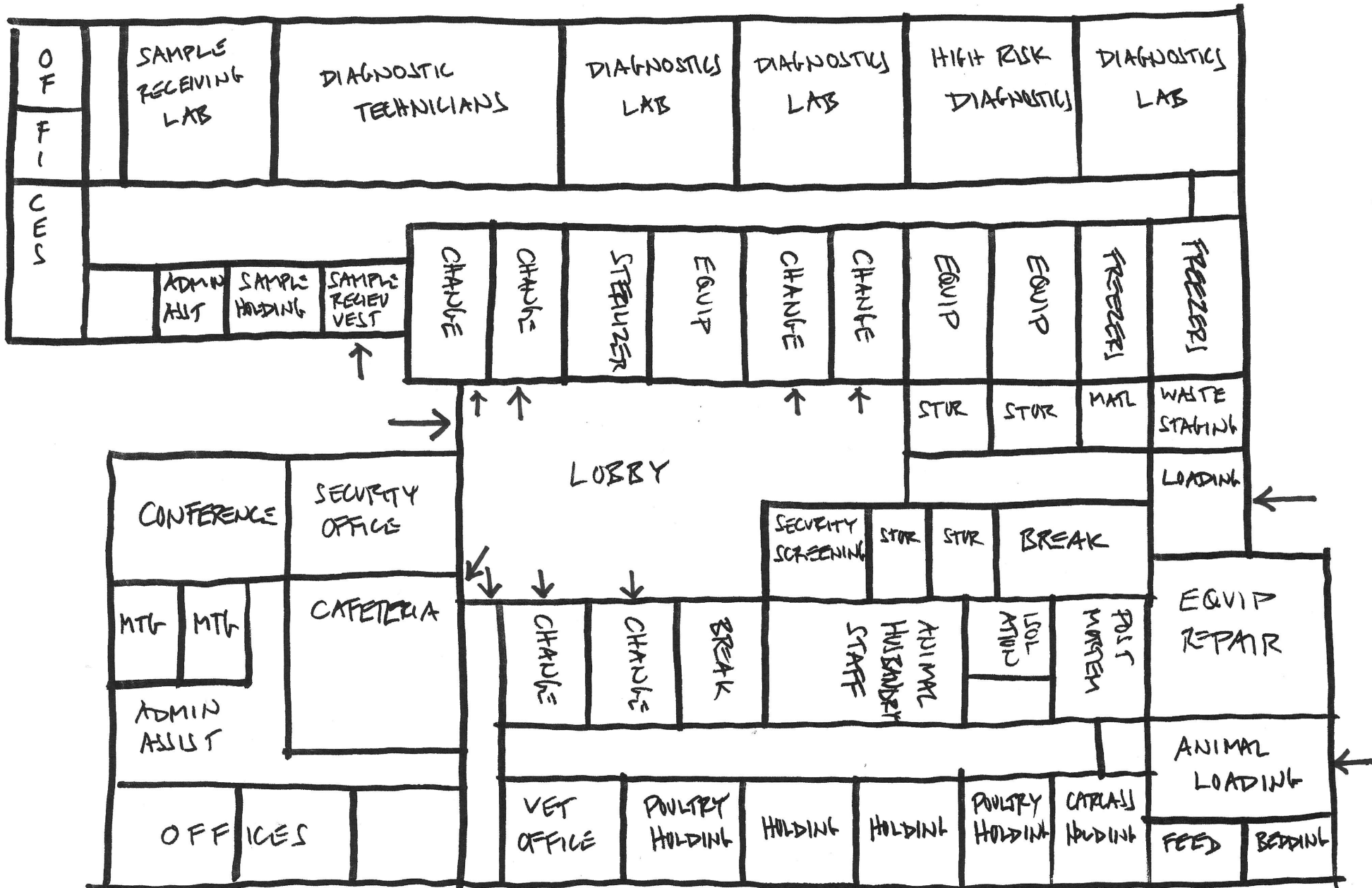

CONCEPT DESIGN - PLAN WITH PROBLEMS TO RESOLVE

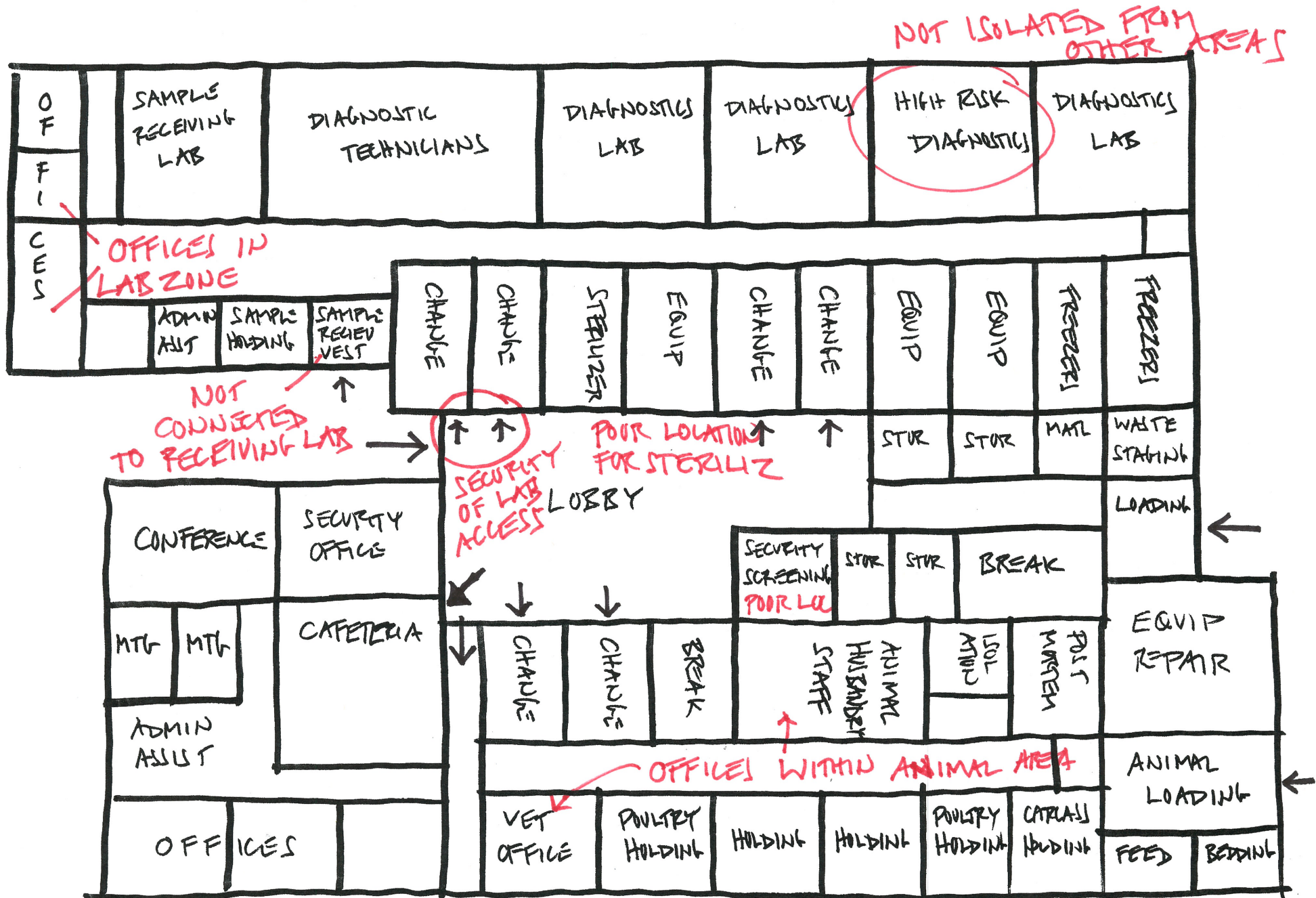

CONCEPT DESIGN - PLAN WITH PROBLEMS TO RESOLVE

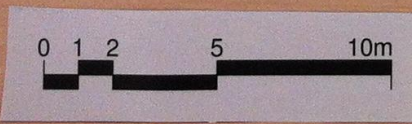
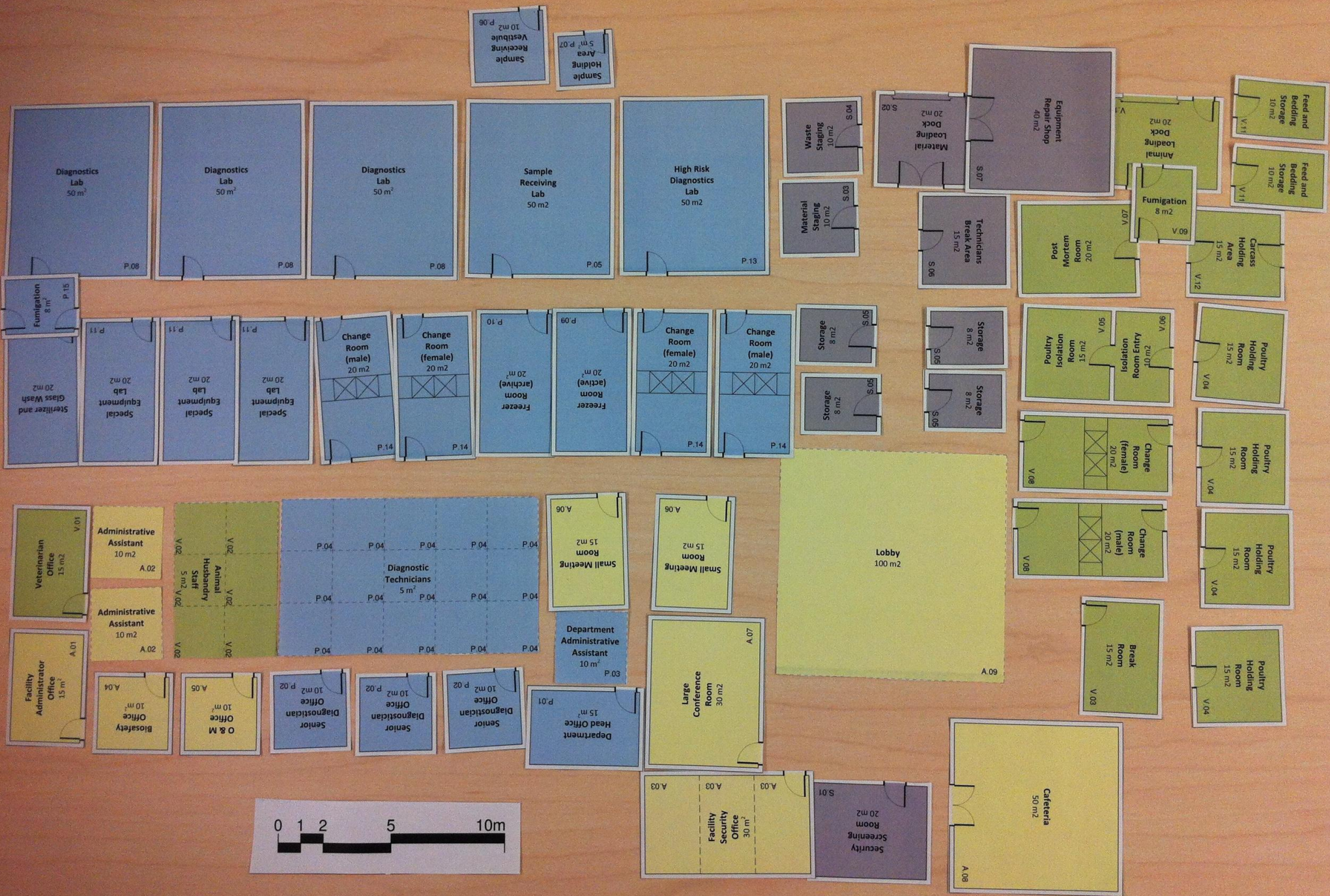

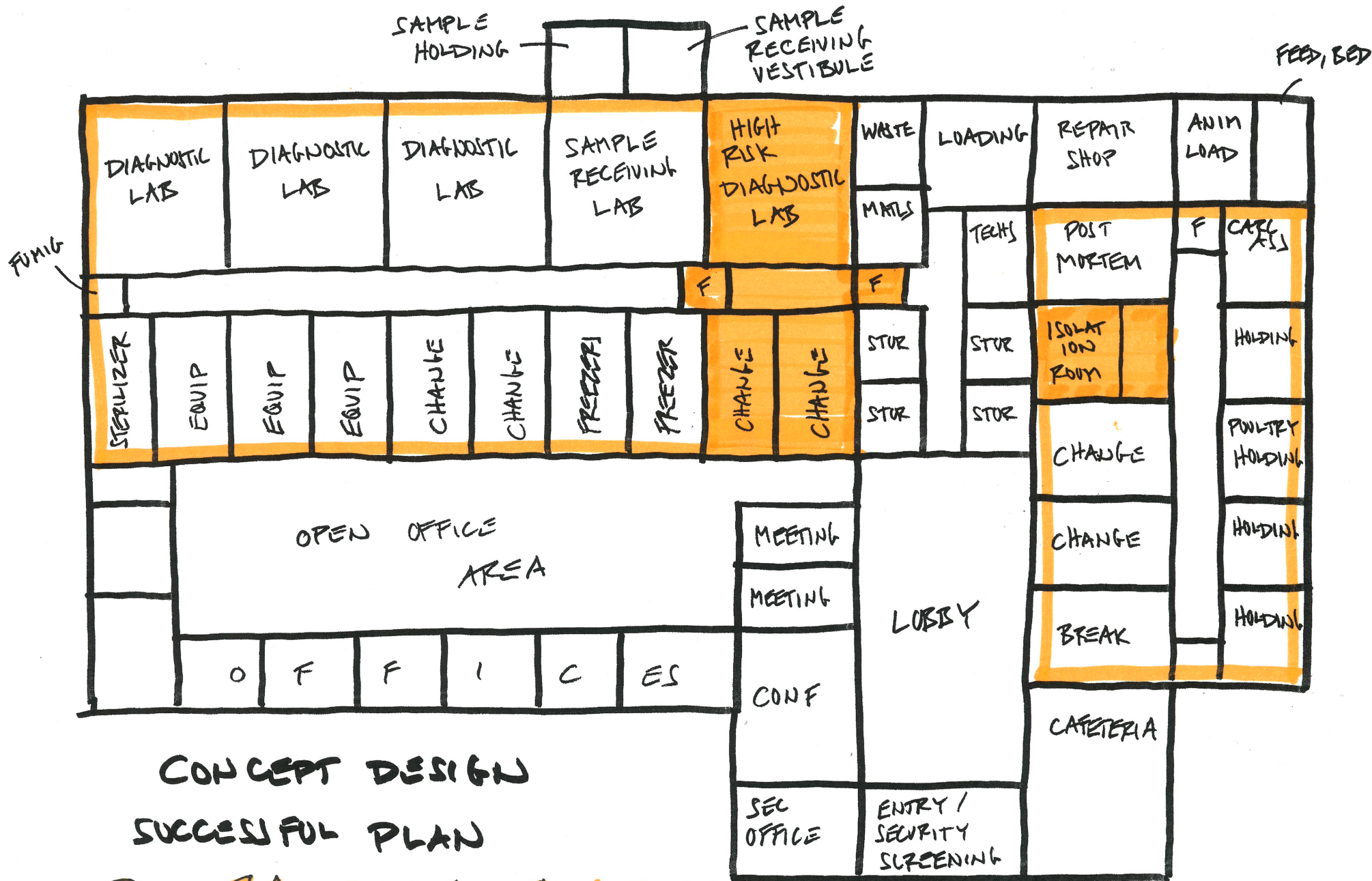

CONCEPT DESIGN

SUCCESSFUL PLAN

CONTAINMENT AREAS

* NOTE SAMPLE FLOW FROM ANIMAL AREA
MAY BE PROBLEMATIC IN THIS EXAMPLE

— SAMPLES
— PERSONNEL
* PROTOCOL POINTS

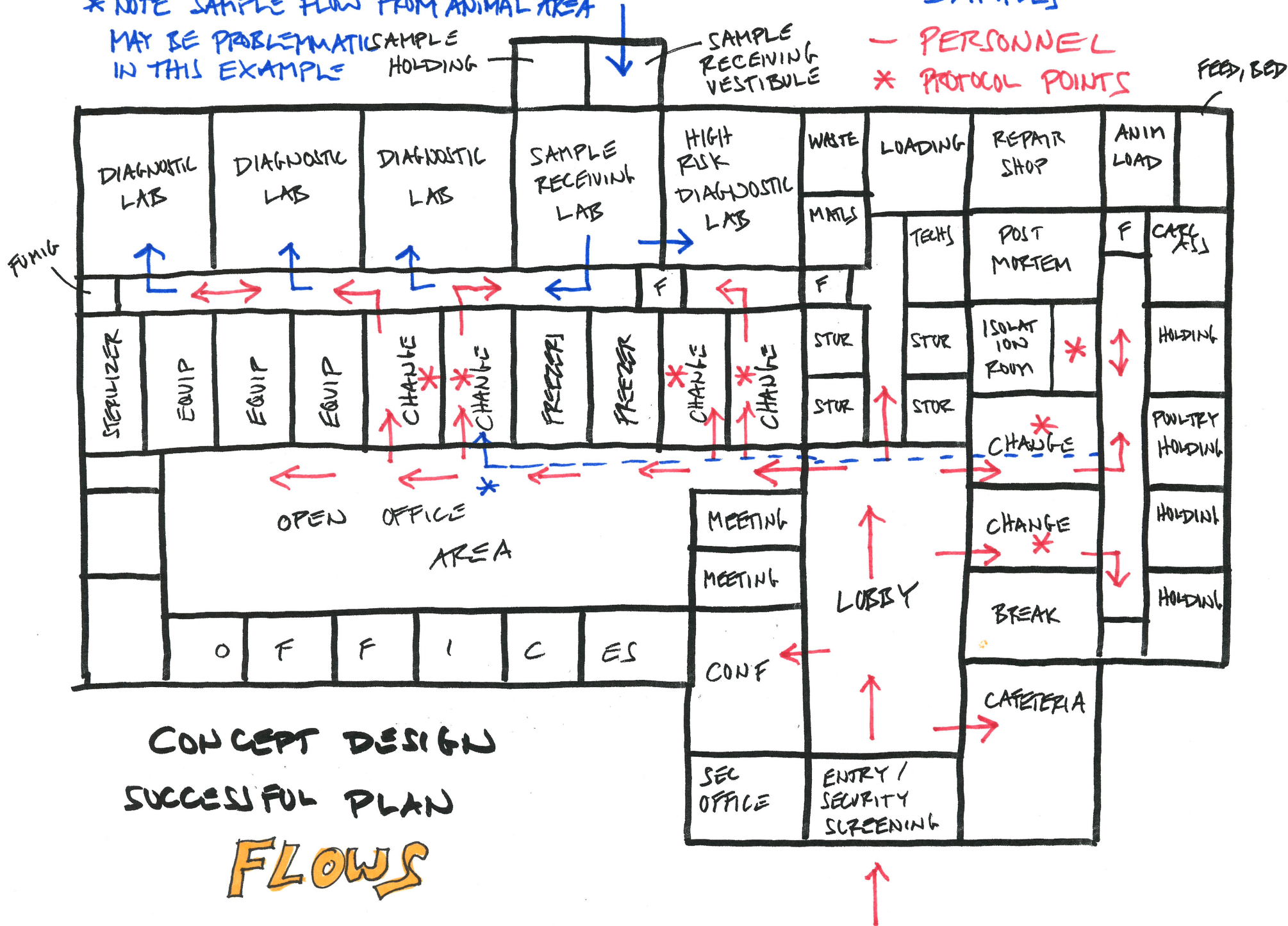

CONCEPT DESIGN
SUCCESSFUL PLAN
FLows

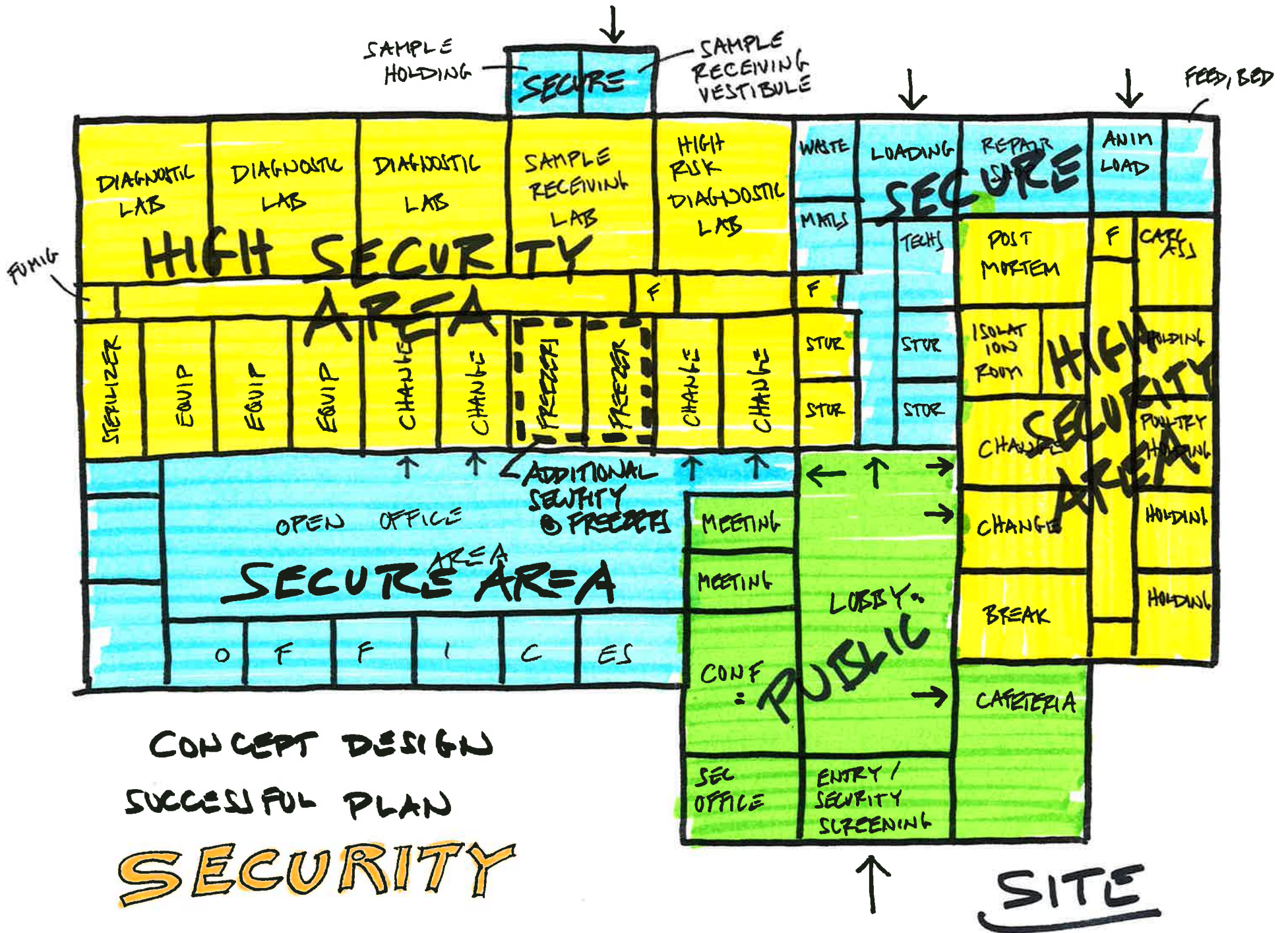

CONCEPT DESIGN
 SUCCESSFUL PLAN
SECURITY

↑
SITE

These room diagrams should be printed and cut out in advance of the class. Provide one full set for each group of students.

Print at 8½" x 11" or similar for student groups.

One copy of these diagrams should also be printed at 2 or 3 x the original scale and laminated for use by instructor in demonstrations.

Print at 17" x 22" or larger.

Note there are two sets of diagrams in this document, one with English labels and one without labels which can be labeled in other languages as needed.

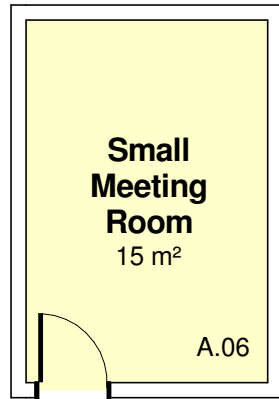
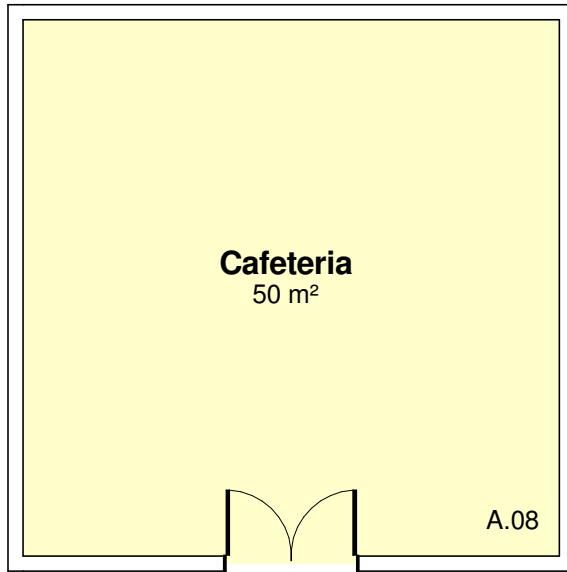
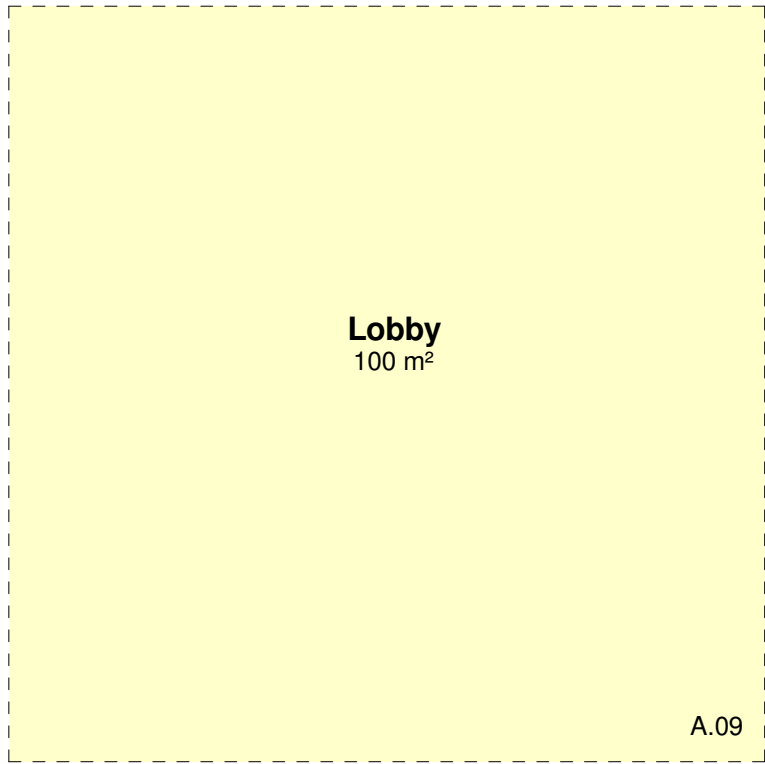
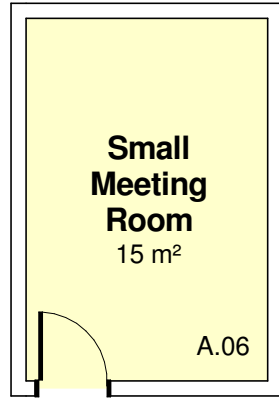
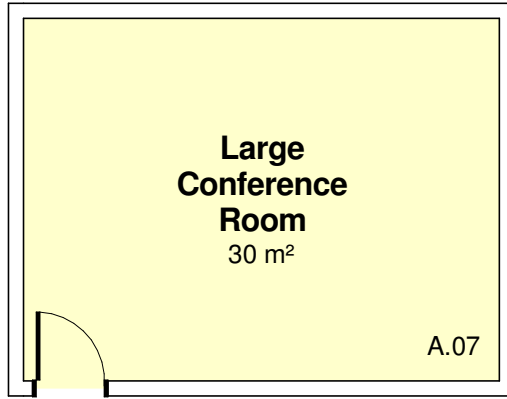
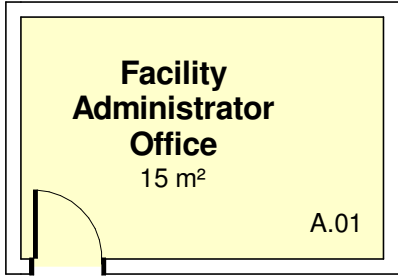
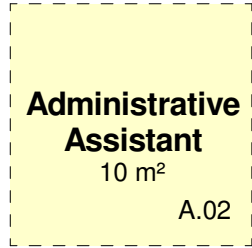
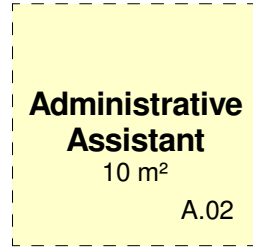
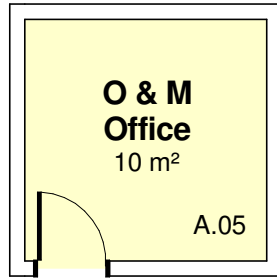
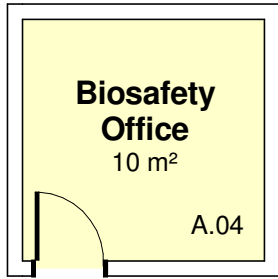
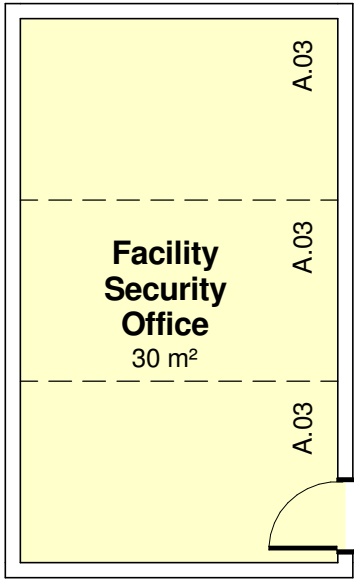

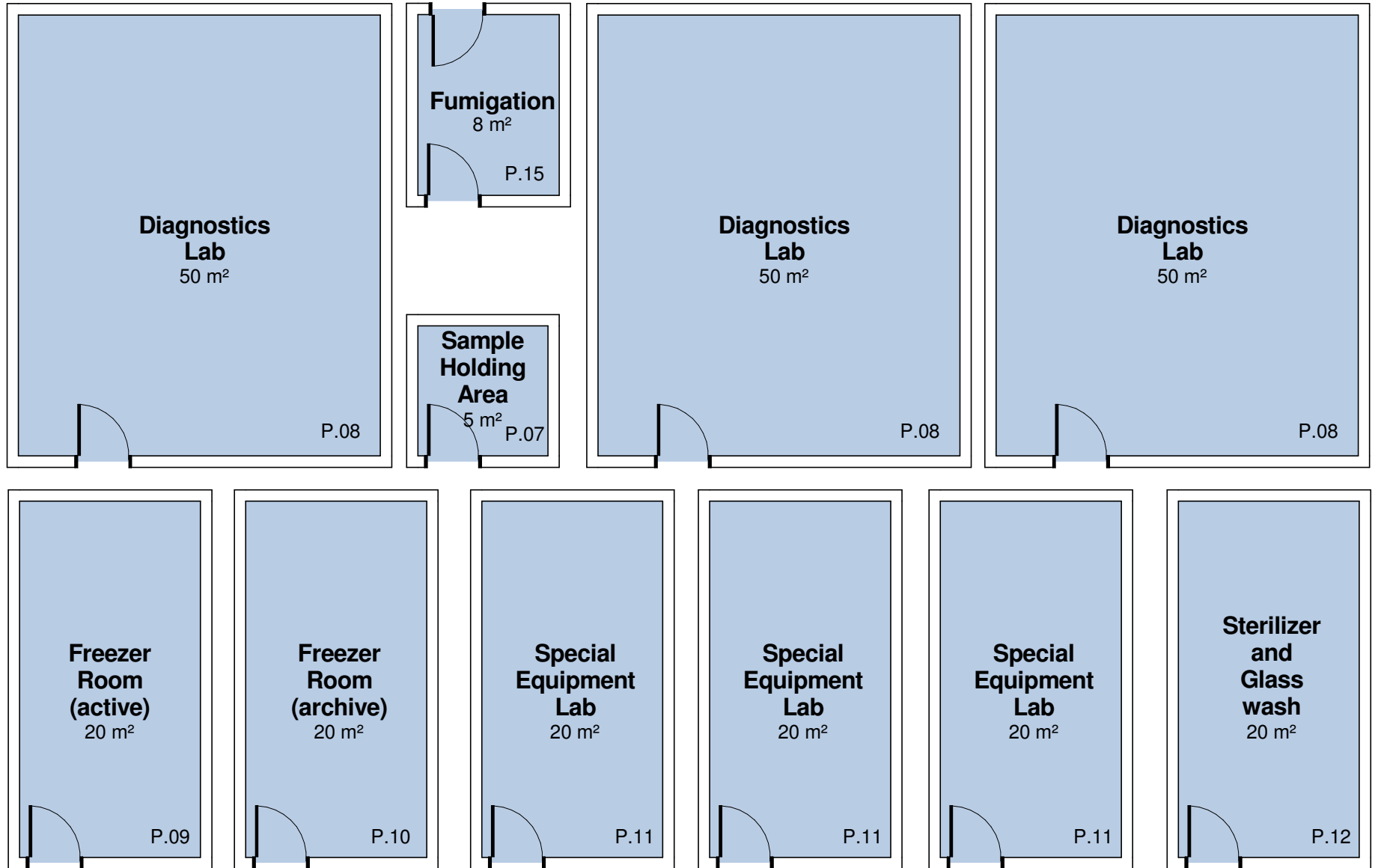
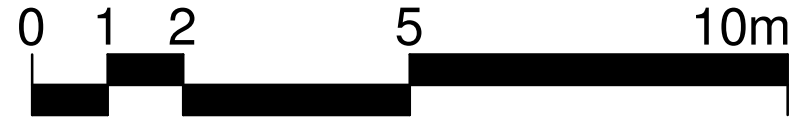

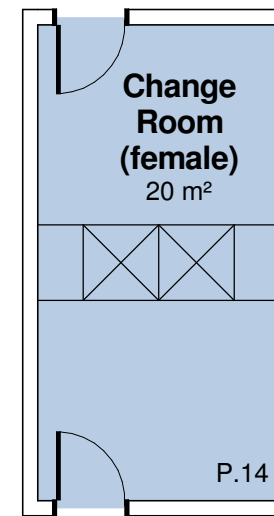
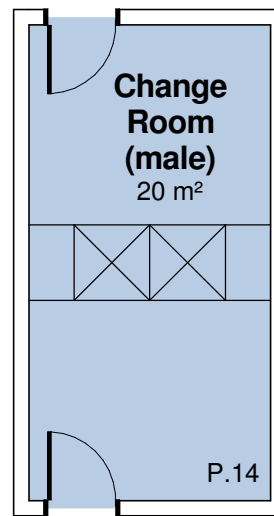
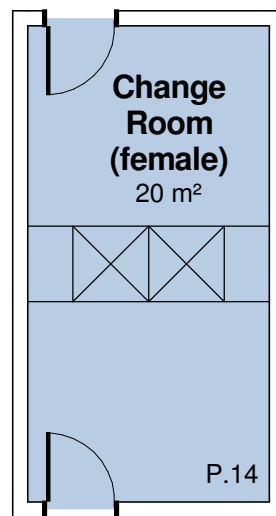
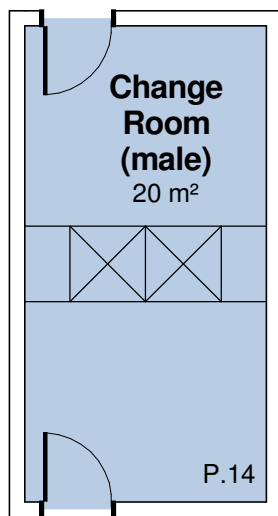
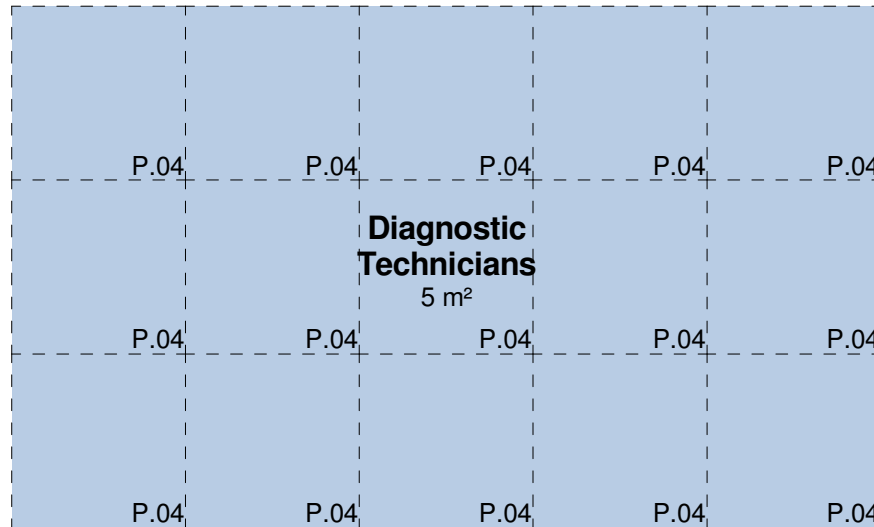
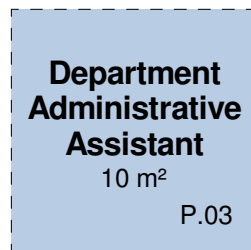
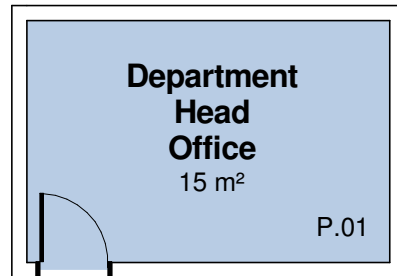
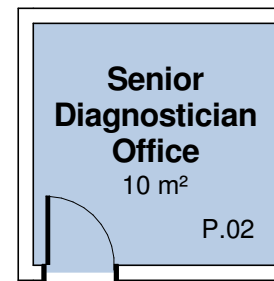
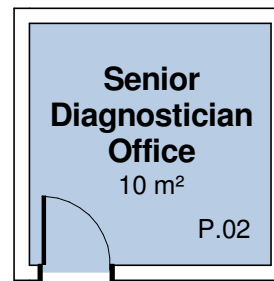
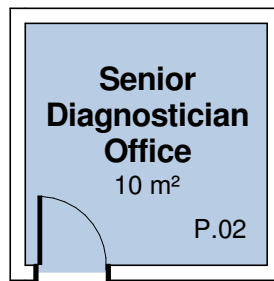
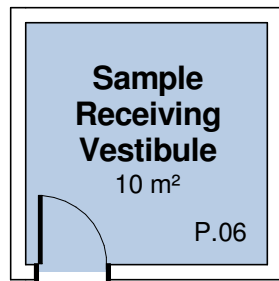
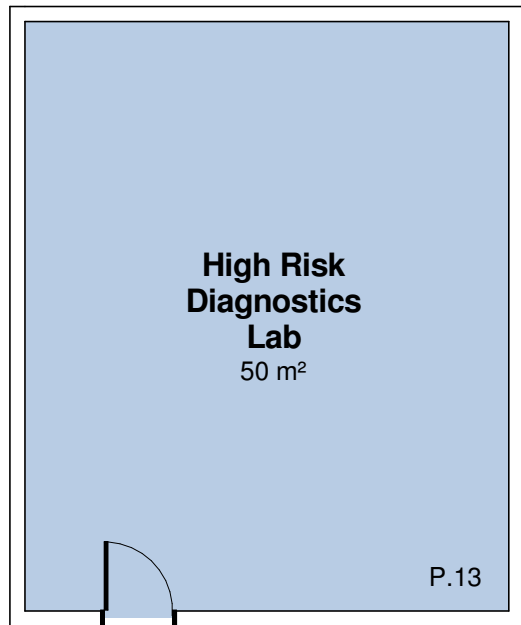
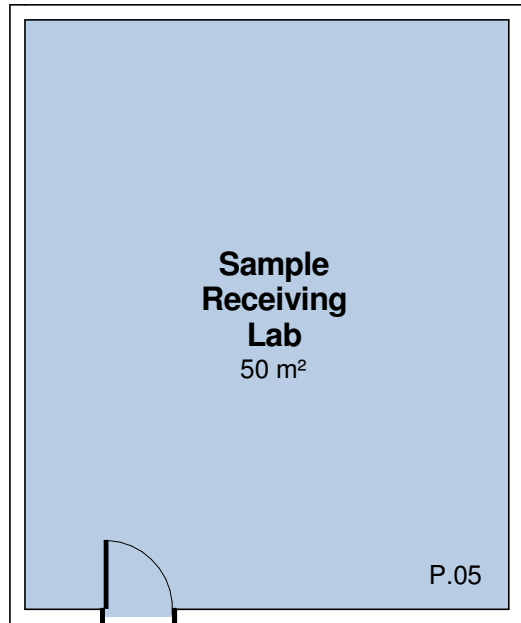

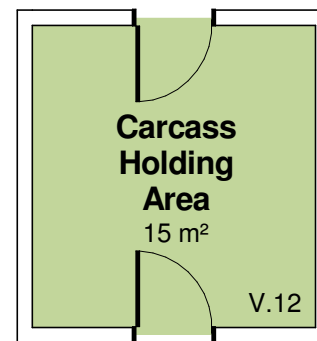
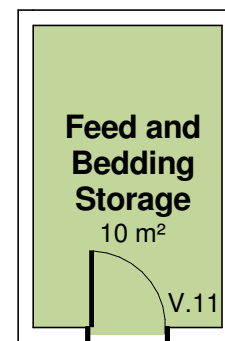
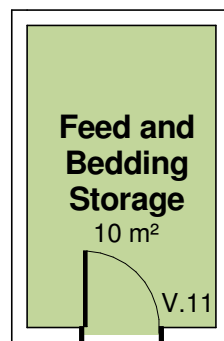
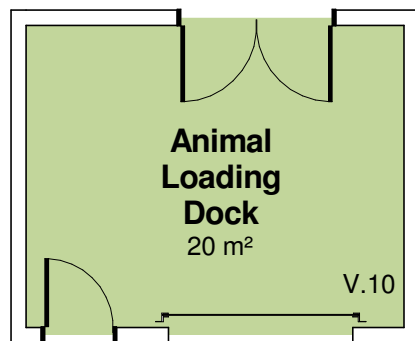
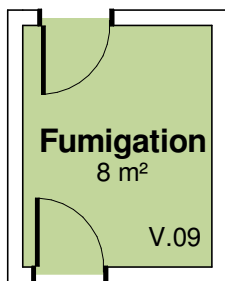
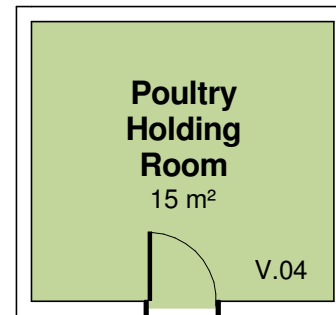
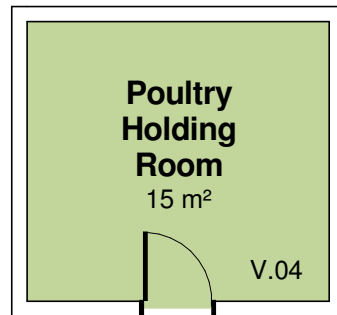
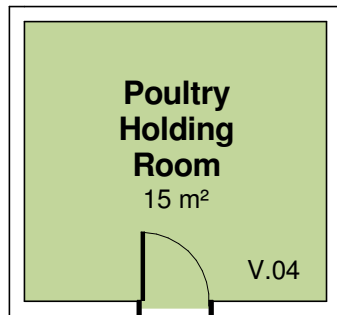
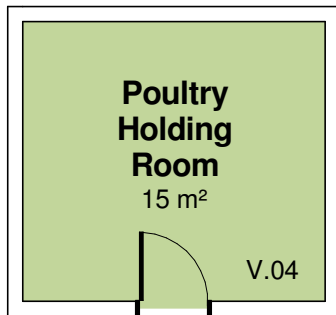
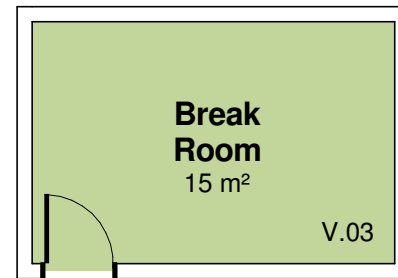
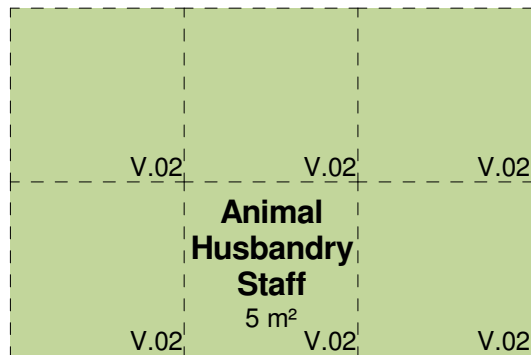

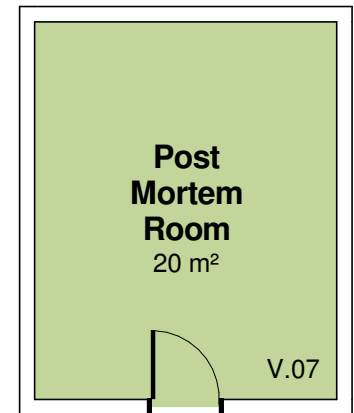
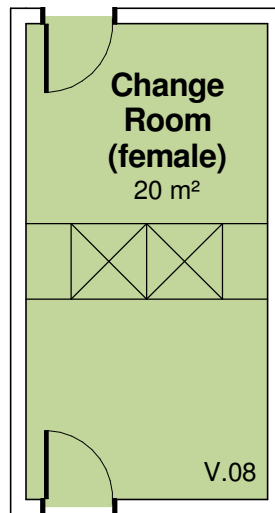
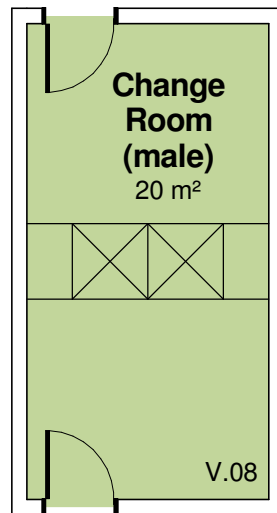
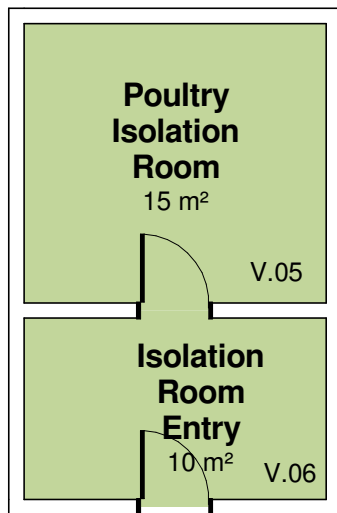
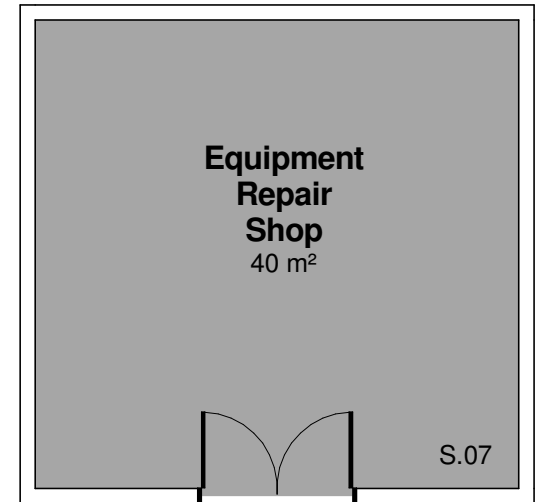
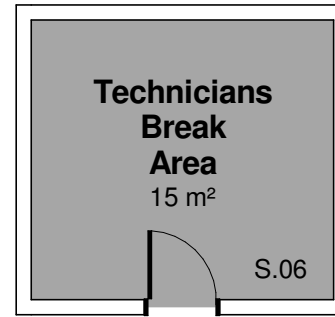
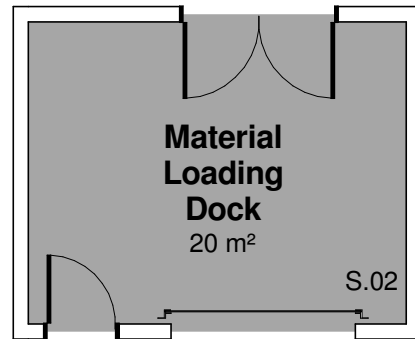
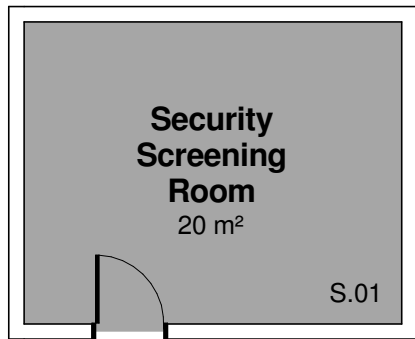
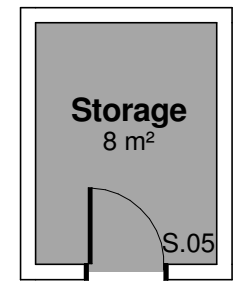
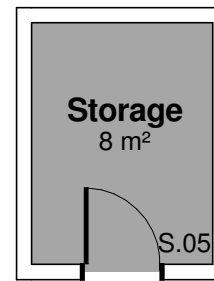
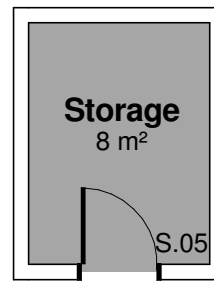
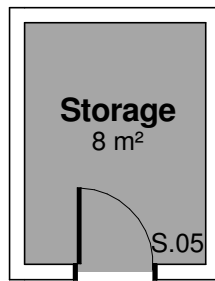
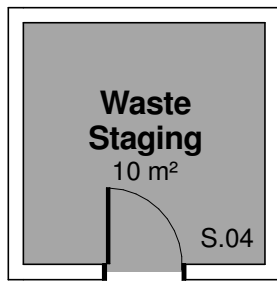
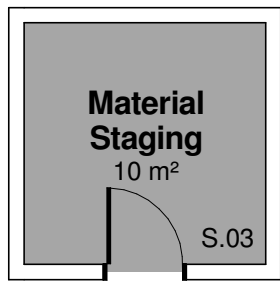

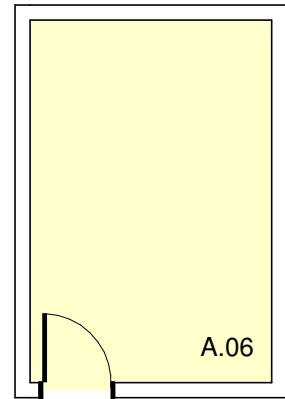
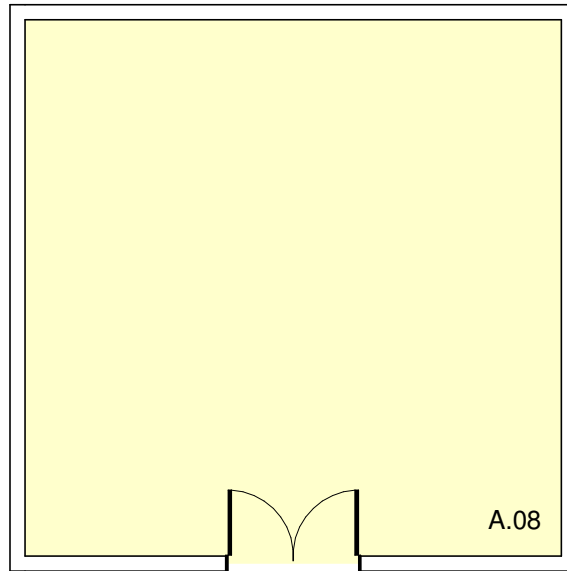
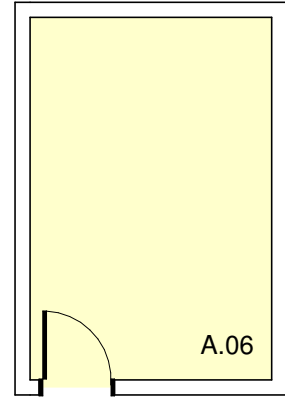
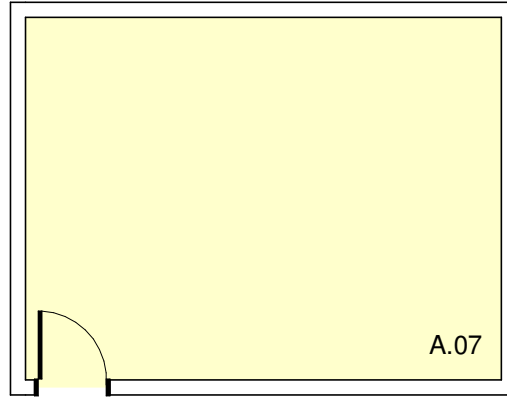
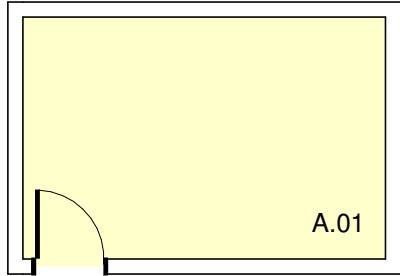
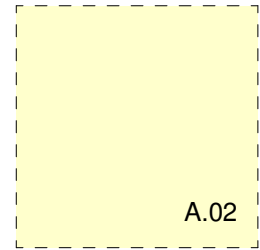
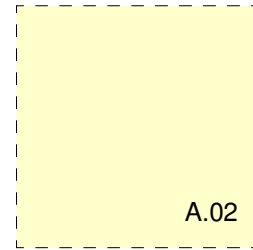
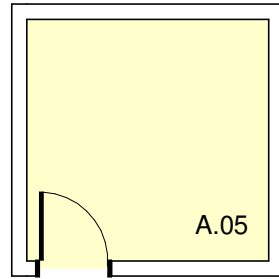
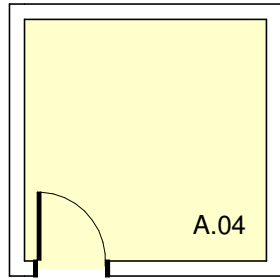
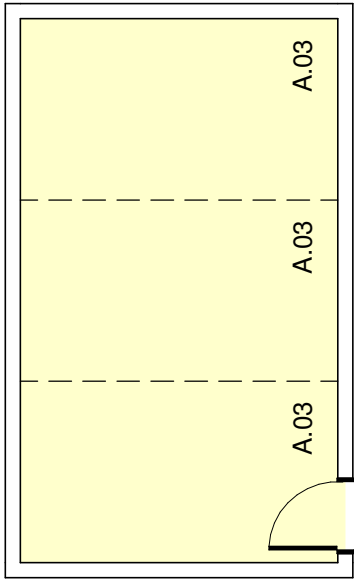

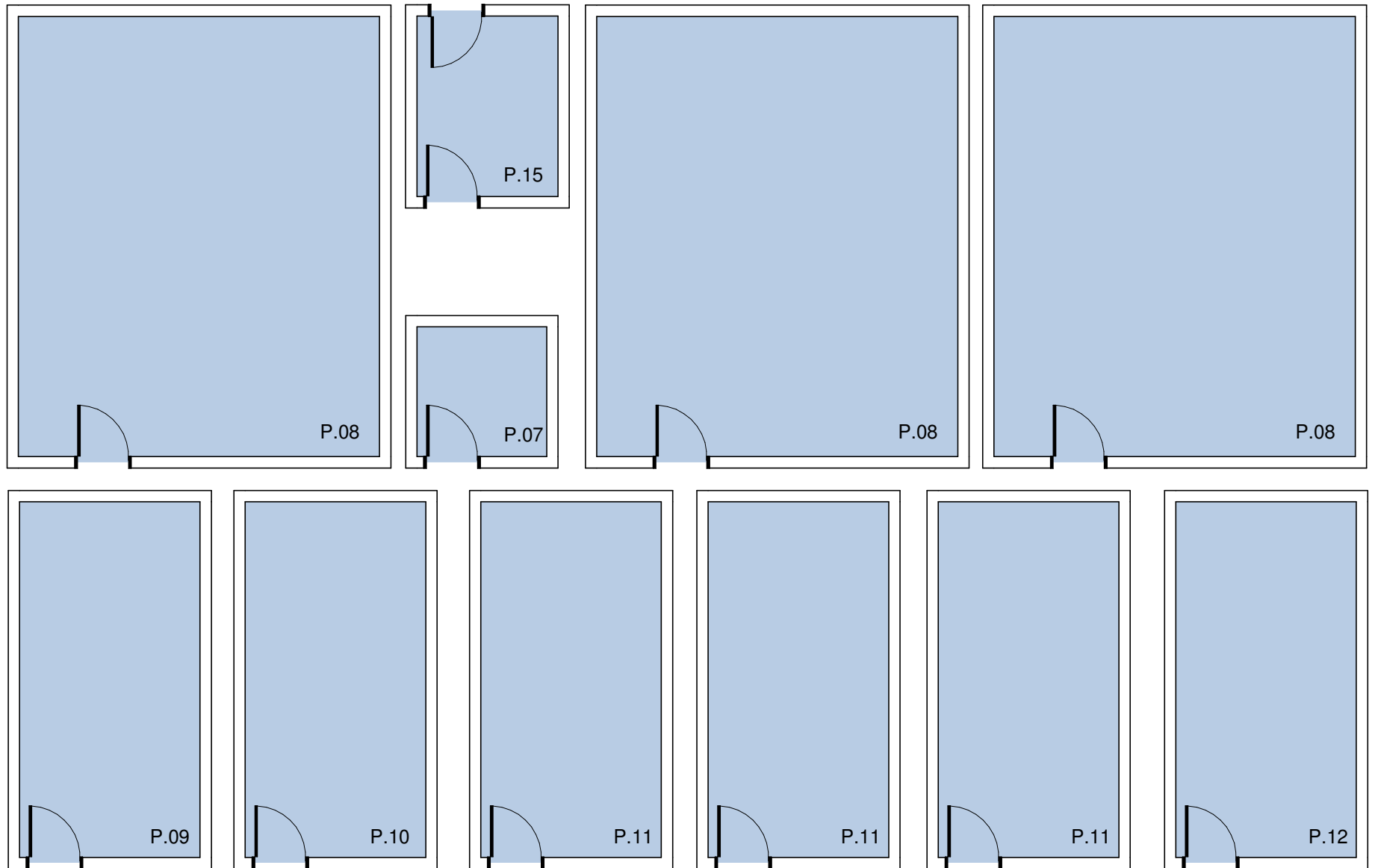
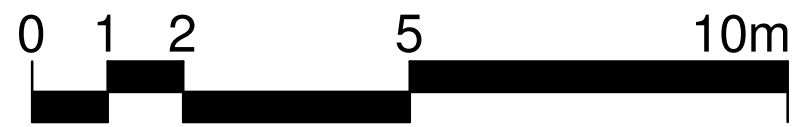

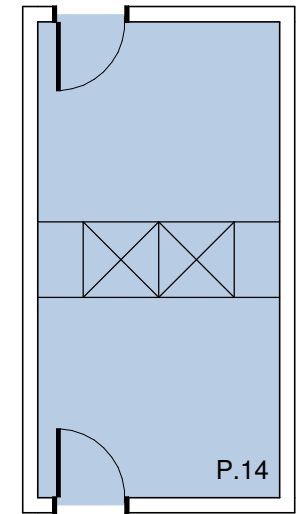
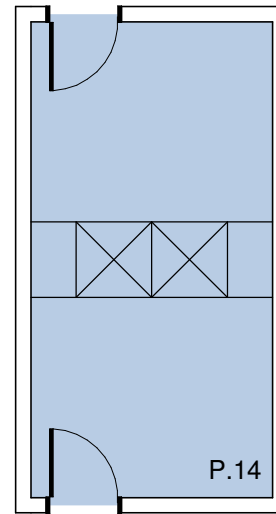
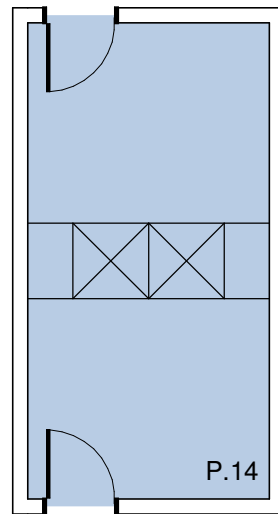
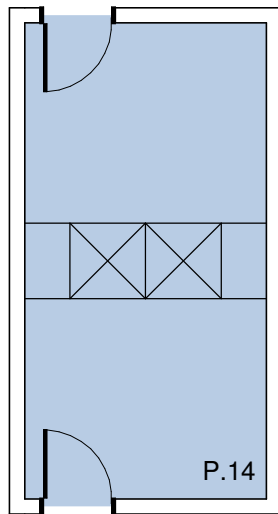
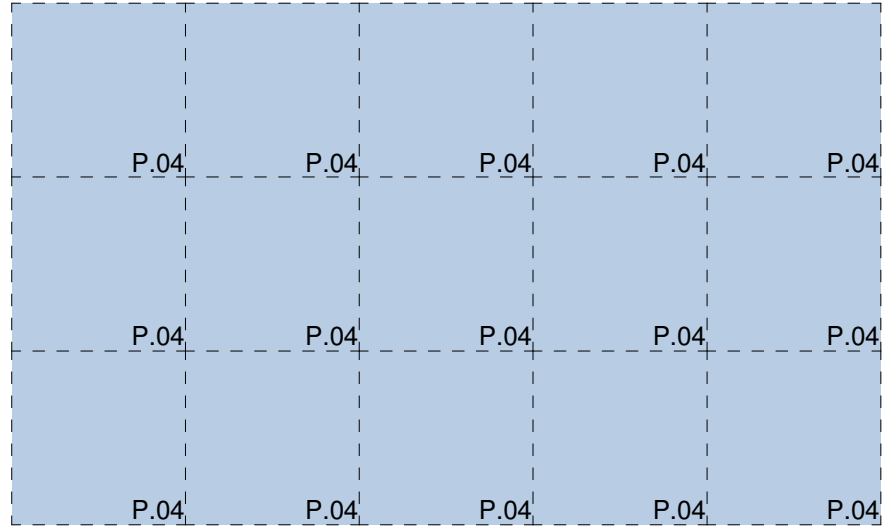
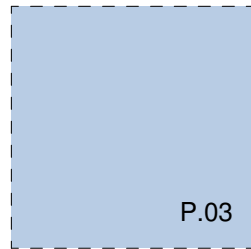
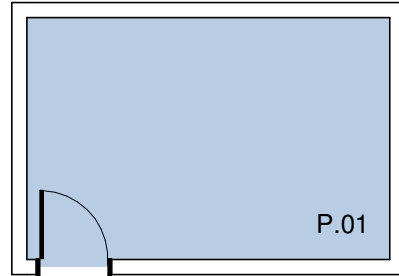
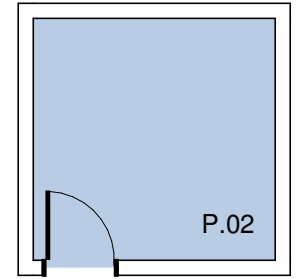
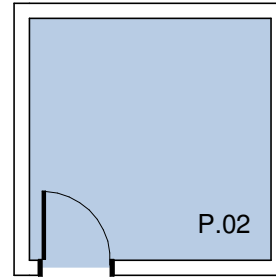
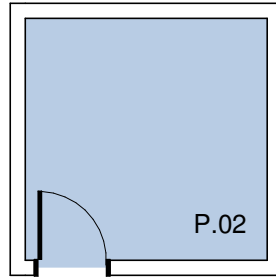
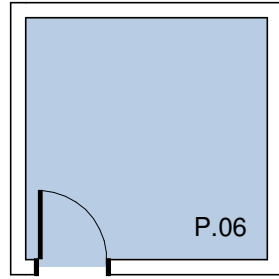
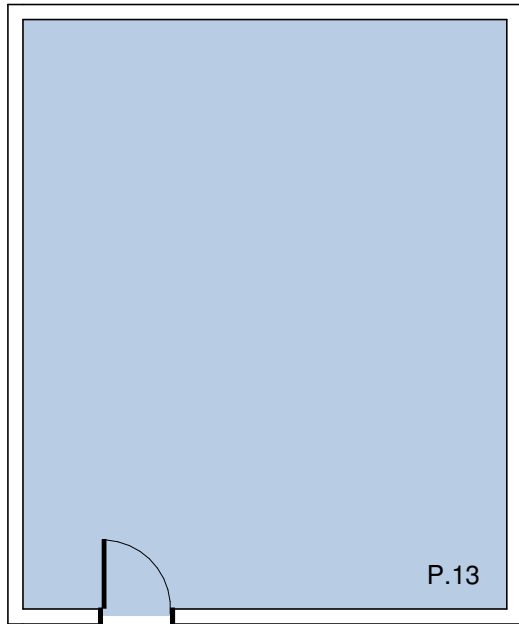
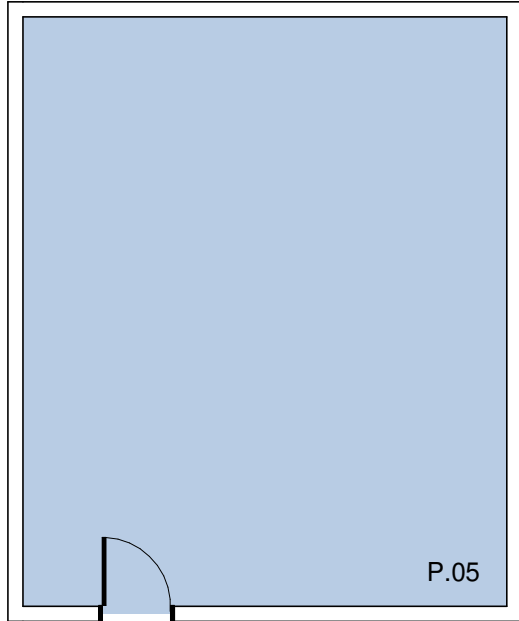

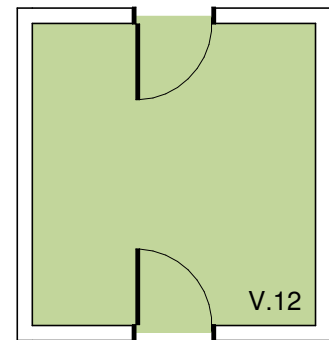
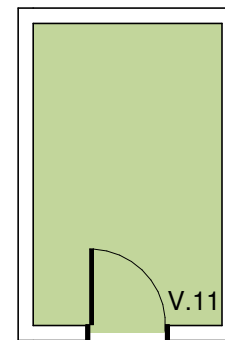
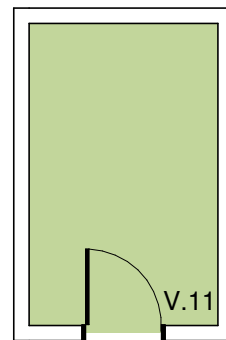
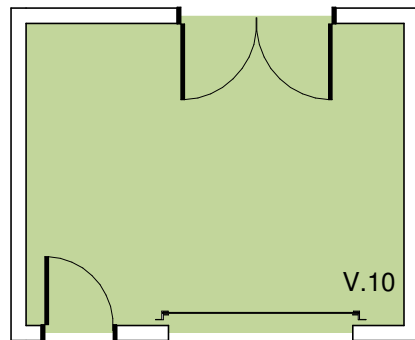
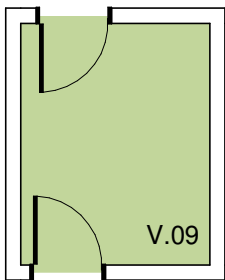
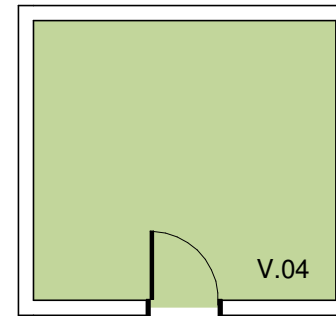
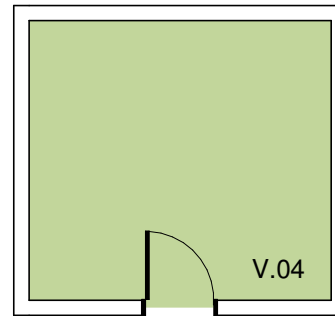
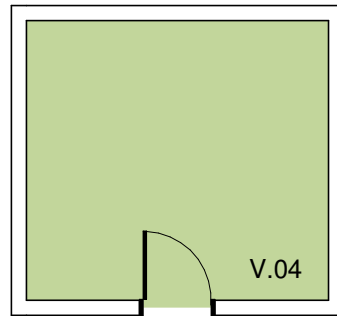
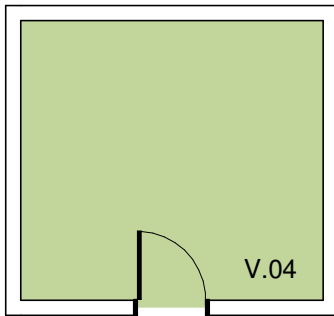
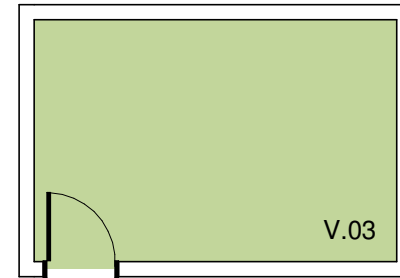
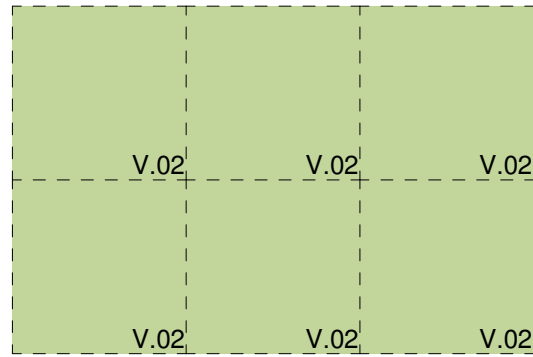
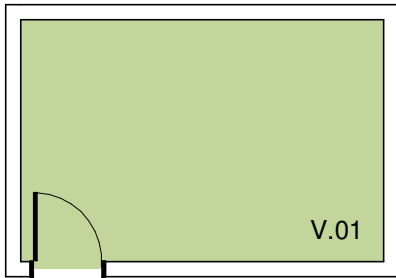

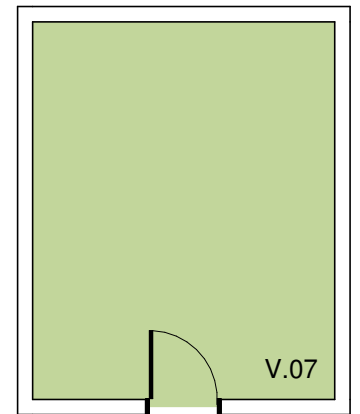
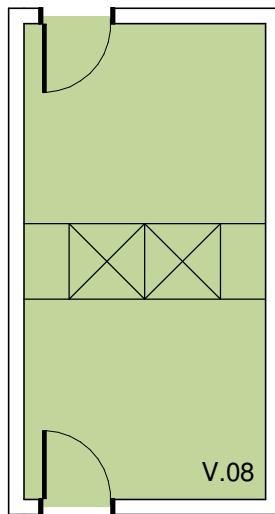
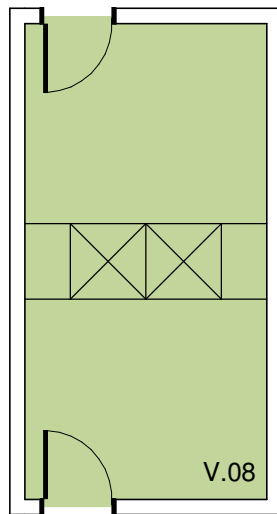
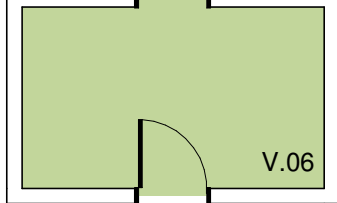
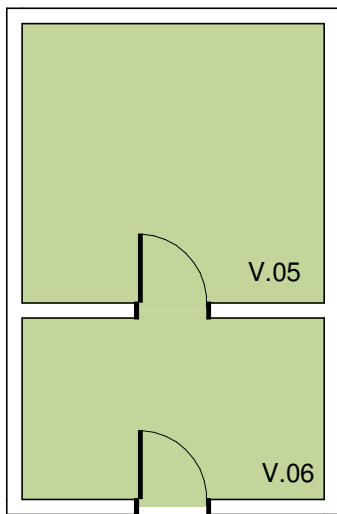
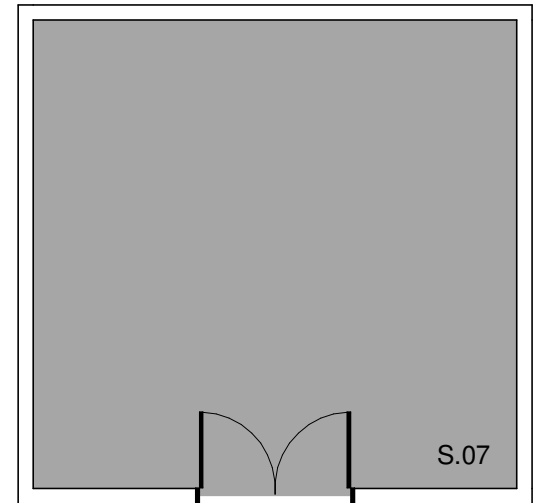
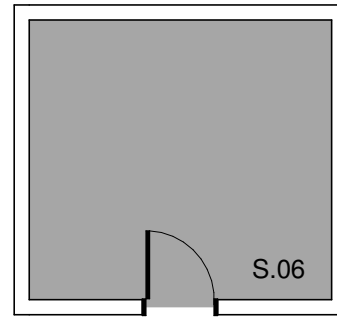
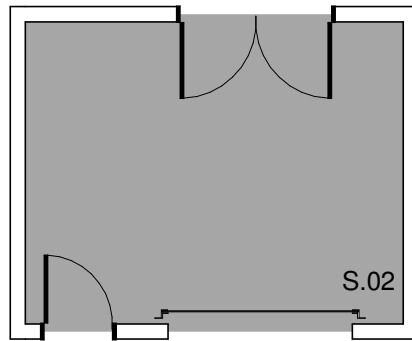
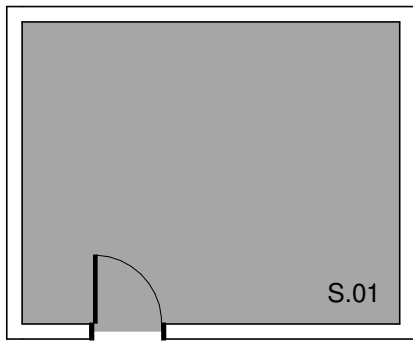
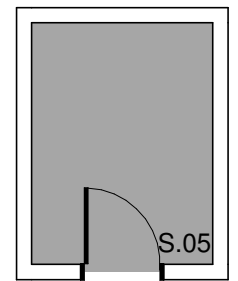
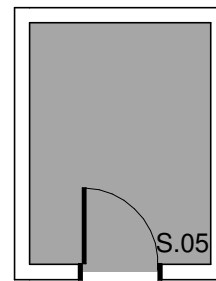
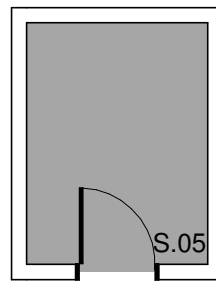
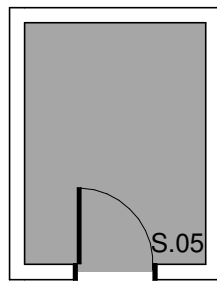
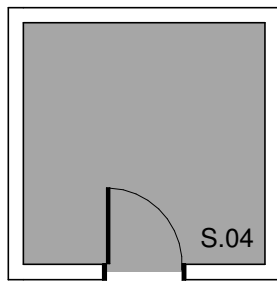
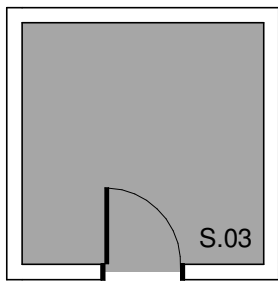

This drawing should be printed out at large scale and laminated
for use with dry erase markers.

Note that there are two copies of the drawing, one with labels
removed for use in other languages.

Print at 17" x 22" or larger.

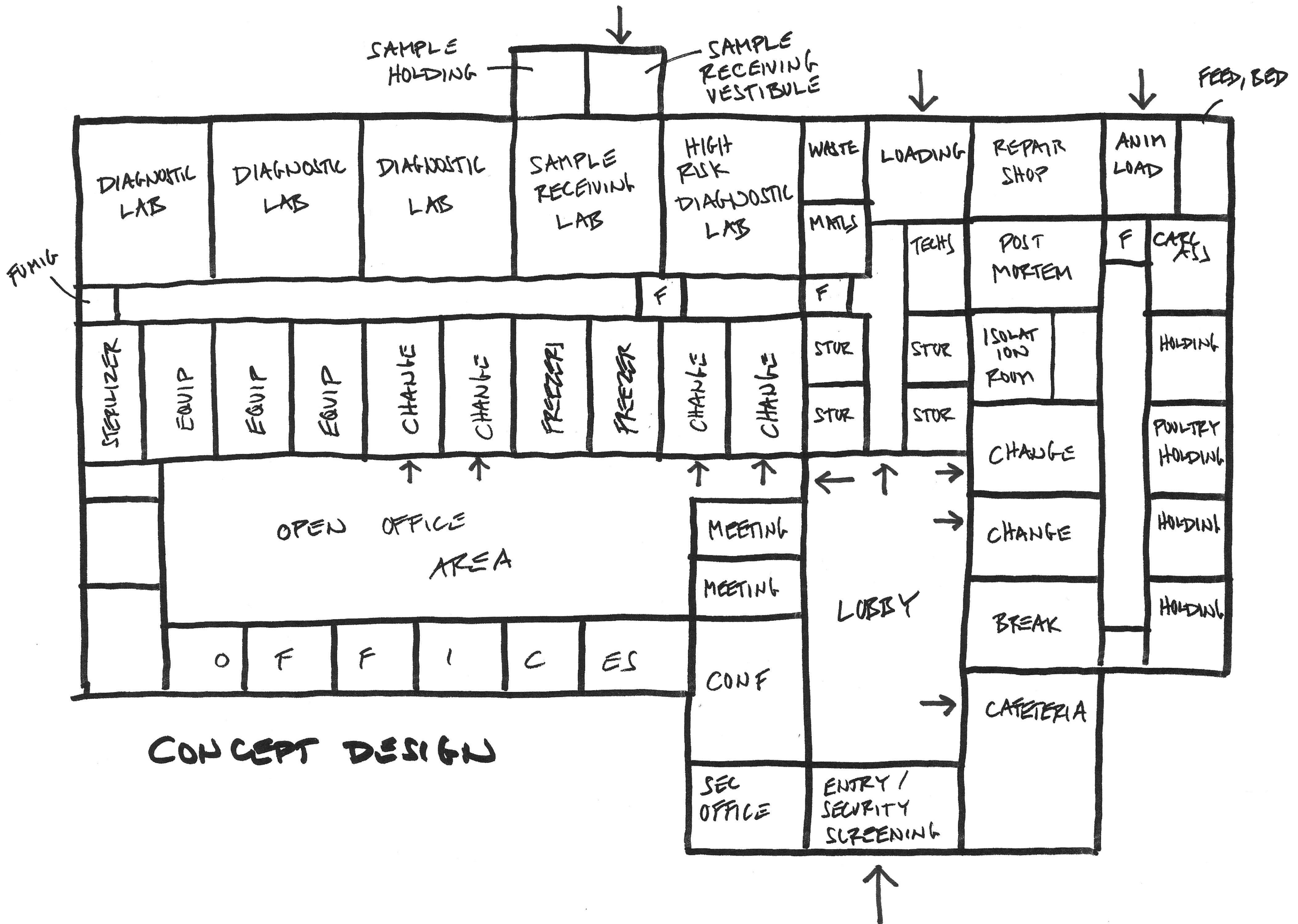

CONCEPT DESIGN

