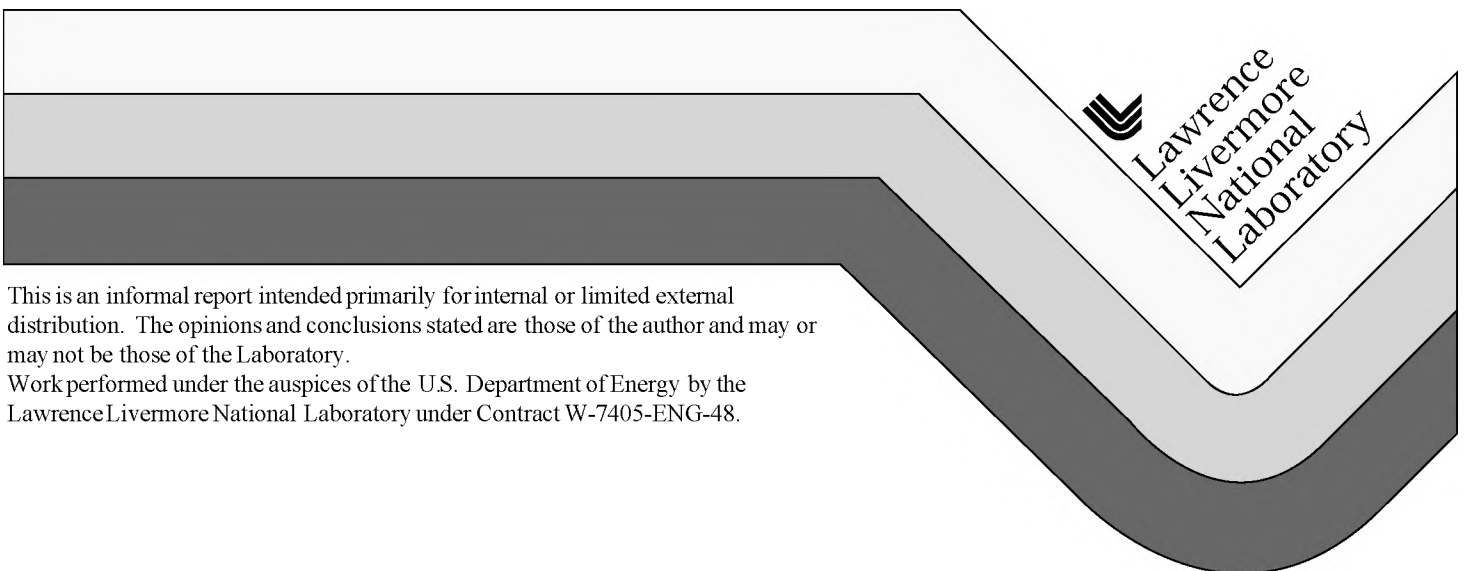


Impact of Zero Order Unconverted Light on Beam Pointing

Dan Kalantar, Sham Dixit, and Richard Lyons

August 24, 1999



This is an informal report intended primarily for internal or limited external distribution. The opinions and conclusions stated are those of the author and may or may not be those of the Laboratory.

Work performed under the auspices of the U.S. Department of Energy by the Lawrence Livermore National Laboratory under Contract W-7405-ENG-48.

DISCLAIMER

This document was prepared as an account of work sponsored by an agency of the United States Government. Neither the United States Government nor the University of California nor any of their employees, makes any warranty, express or implied, or assumes any legal liability or responsibility for the accuracy, completeness, or usefulness of any information, apparatus, product, or process disclosed, or represents that its use would not infringe privately owned rights. Reference herein to any specific commercial product, process or service by trade name, trademark, manufacturer, or otherwise, does not necessarily constitute or imply its endorsement, recommendation, or favoring by the United States Government or the University of California. The views and opinions of authors expressed herein do not necessarily state or reflect those of the United States Government or the University of California, and shall not be used for advertising or product endorsement purposes.

This report has been reproduced
Directly from the best available copy.

Available to DOE and DOE contractors from the
Office of Scientific and Technical Information
P.O. Box 62, Oak Ridge, TN 37831
Prices available from (615) 576-8401, FTS 626-8401

Available to the public from the
National Technical Information Service
U.S. Department of Commerce
5285 Port Royal Rd.,
Springfield, VA 22161

National Ignition Facility Project

Mail Station L-473

Ext: 2-6147

August 24, 1999

NIF-0033352

To: Distribution

From: Dan Kalantar, Sham Dixit, and Richard Lyons

Subject: **Impact of zero order unconverted light on beam pointing**

There is a significant amount of unconverted light incident in the NIF target chamber. The baseline plan for managing this light is to use a sub-aperture CSG design. This CSG selection impacts the target chamber and near-opposing FOAs due to: (1) zero order unconverted light footprint, and (2) high order dispersed unconverted light. In this memo we describe the impact of the zero order light on the range of beam pointing for individual beams. We show that zero order footprint for 1w light enters into the near-opposite FOAs for several ports if the beams are pointed away from the target chamber center. Additionally, for the case where 3w is allowed to propagate past target chamber center, the converted light may enter into the near-opposite FOAs. The second aperture in the PAM is required to protect the FOAs and still accommodate offset beam pointing on NIF. We present details on the aperture requirements to accommodate a range of beam pointing.

Background

The NIF target chamber is designed with no directly opposing ports. This is accomplished using a rotational offset of 11.25° for the beam port pattern on the top vs. the bottom of the chamber. In this configuration, the footprint of unconverted light on the opposite wall of the chamber is located between two adjacent nearly opposing beams. As beams are pointed away from chamber center, however, the footprint of the unconverted light may be directed into the aperture for a nearly opposing beam.

For the Haan pulse shape, the average fluence of the zero-order unconverted light (light that is not deflected with the sub-aperture color separation grating) is approximately 13 J/cm^2 on the opposite wall of the NIF target chamber. If this is allowed to propagate into the FOA, the average fluence is approximately 6 J/cm^2 at the debris shield, with peak fluence up to an order of magnitude higher.

The average fluence due to unconverted light exceeds the damage threshold for the first wall material and for all aluminum structures in the

University of California



FOA. To prevent ablation of the first wall by the high intensity unconverted light from impacting the final optics of the a near-opposing FOA, we need to confine the footprint of the zero-order light to fall on the first wall, and not into a near-opposite FOA. If this cannot be avoided, then a mitigation strategy for absorbing this light is required.

In addition, for the case where targets such as gasbags or point backlighter fibers, there is the possibility that some of the converted 3w light will propagate to the opposite wall, impacting the near-opposite FOAs. This may be at an average fluence as high as 8 J/cm^2 at the debris shield of a near-opposite FOA. Again, the peak fluence may be higher due to modulation in the beam.

Options to protect the FOA

There are several options to protect the nearly opposing FOAs:

1. Do nothing.

The fluence of x-rays at the debris shield may be as high as 1 J/cm^2 . Shielding provided to protect the Al surfaces from the x-rays may also protect from converted and unconverted light. However, while the x-ray fluence will be nearly uniform at the FOA, the fluence of unconverted light will have an average of up to 6 J/cm^2 and a peak value as much as an order of magnitude higher. This may result in substantially more debris generated near the debris shield. We recommend that the light be managed so that high intensity unconverted 1w or converted 3w does not enter near-opposite FOAs.

2. Impose limits on the range of pointing on some of the beams

For maximum experimental design flexibility, it is desirable not to impose limits on the range of beam pointing. Engineering and other practical constraints may impose separate limits on beam pointing, but we do not consider this option here.

3. Block the zero order unconverted light with large shields at target chamber center for all target shots

The shields required to block all the zero order unconverted light at the target plane would be approximately 50 mm diameter. Such shields would be the source of significant debris and shrapnel in the target chamber. In addition, this would not be effective for targets with backlighter foils, or for beams that are pointed at a backlighter, typically the situation for a beam that is incident in a near-opposite FOA. We do not consider this option here.

4. Reduce the aperture for beams that impact near-opposite FOAs using a telescope adjustment.

There is a telescope adjustment in each beam located in the PAM (ECR228). This is intended to allow small magnification changes from 0.95-

1.02. In order to use this to protect near-opposite FOAs for full beam pointing about target chamber center, the telescope adjustment would have to cover a range from less than 0.5 to 1.0 magnification. To extend the range to a magnification of 0.5 is unreasonable since it may put the beamlines at risk of damage if a telescope is left in the wrong position for a high energy shot. We do not consider this option here.

5. Clip one edge of the beam in the PAM, or just turn off a single beam.

This option would offer the most flexibility in target design without impacting the target chamber itself. In this memo we discuss the requirements for clipping beams based on the unconverted light incident at the target chamber wall. The effect of 3w is also discussed.

Analysis of impact

The IDL model of unconverted light (ULMV, Research Sciences, Inc.) was used to evaluate the interference of the high intensity laser light on near-opposite FOAs. This was then checked with a Pro/E model. We measured the proximity of the beam footprint (1w zero order unconverted light and converted 3w light) to the aperture in the first wall for the near-opposite FOAs, and then we evaluated the limit on beam pointing away from chamber center if no aperture is introduced.

We determined the overlap for beams pointed away from the target chamber center to estimate the maximum interference that can be expected. A ± 30 mm pointing offset in the two transverse directions (relative to the beam) was used with the maximum beam defocus of -48 mm. These estimates were also repeated for a 50 mm transverse range of pointing. Note that the NIF beams are nearly $f/20$. The defocus does not affect the overlap significantly.

We used an FOA aperture size of 640 x 685 mm located at 4632 mm from the target chamber center to estimate the beam-FOA interference. This FOA aperture is defined by a flashing aperture frame that is 630 x 675 mm with a ± 5 mm placement tolerance as described in design document NIF-5002563.

Figure 1 shows an equatorial projection of the top half of the NIF target chamber. The footprint of quads of beams entering through the FOA beam ports on the top half of the chamber are shown inside the outlines of the FOA ports and beam apertures in the first wall. In addition, the footprint of each beam entering through ports in the bottom of the chamber are shown incident on the first wall between the beam ports in the top half of the chamber. Marked on this figure are the locations where the zero order unconverted light footprint impacts a near-opposite FOA when the beam is pointed up to 50 mm offset from chamber center. Beams from a total of 32 quads are affected.

We calculated the closest distance between the nearest beam footprints and the first wall opening for an adjacent beam for each pair of beam quad

ports on NIF. The results are shown in Table 1. The range of motion for a full aperture beam before it interferes with the near-opposite FOA aperture is also listed in this table. For a 30 mm transverse offset in the $\pm x$ -direction (See Fig. 3), the footprint of that beam moves by $\pm(4632 \text{ mm} + 7700 \text{ mm}) / (7700 \text{ mm}) = \pm 48 \text{ mm}$ at the first wall. In order to achieve a $\pm 50 \text{ mm}$ range of pointing, the footprint of the beam moves by $\pm 83 \text{ mm}$ at the first wall. Note that we have included only those beams that interfere when the beam is pointed up to 50 mm from target chamber center in any direction.

Figure 2a shows an enlarged view of the beam footprints from Q43B (port 59) incident near port 15. In this case, the footprint of the 1w is about 5 mm from the FOA aperture for the Q25T beams. As the Q43B beams are pointed off chamber center by up to 50 mm, the unconverted light footprint will enter the FOA aperture at port 15 if the corner of the beam is not clipped. The corresponding 3w footprint is shown in Figure 2b. Because of the larger footprint, we see that if the 3w beam is pointed to chamber center and allowed to propagate past the target, it enters into the near-opposing FOA. Due to the symmetry of beam port locations on NIF, there are eight such ports with this interference in the upper half and eight in the lower half of the target chamber.

The close proximity of the beam footprints and beam pointing limitations before interference occurs as shown in Table 1, indicate that we need to reduce the beam size to allow the full range of pointing. This results in a loss of available energy for that quad. We calculate the loss in beam area (and energy) for the 4 beams in each affected quad. This is expressed as an equivalent number of beamlets out of 4 for the 2 cases of a) 30 mm pointing offset and b) 50 mm pointing offset. These are shown in Table 2. Note that in some cases to achieve the full range of pointing for all four beams within a quad, the area lost by placing an aperture in the PAM is more than the single beam area. In this situation, it makes more sense to just turn off one beam in the quad.

We have assessed the requirements for beam apertures based on beam pointing for each quad of beams, and the results are presented as a beam alignment recipe in Table 3. For example, beams in quad Q11T enter through port 17 may impact the FOA located on port 54. Specifically, if the Q11T beams are aligned in the $-x$ direction, by $\leq 30 \text{ mm}$, we recommend an aperture be used to reduce the beam area. And, if the beam is aligned beyond 30 mm, we recommend removing the aperture and turning off beam Q1 in this quad (See Fig. 3).

A total of 40 quads must have an aperture in the PAM. Detailed aperture shapes and sizes will need to be calculated and must include any corrections for limits on beam pointing for specific beams that may arise, for example due to the mirror structures in the switch yards and target area. The approximate shape of each aperture is shown in the listing of notes following Table 3. Note that these apertures are drawn to represent the shape of the beam as it enters the FOA. The orientation of the aperture in the PAM will be

rotated by 90° . The direction of this rotation depends on whether the quad has a LM6 mirror.

The approximate apertures have been defined for the Indirect Drive NIF configuration. When we consider other target configurations that use the direct drive ports (direct drive or tetrahedral targets) or NWET applications, the aperture sizes and the requirements on beam pointing may be different.

Table 1: Listing of beams affected by the zero-order light incident close to the near-opposite FOA. The range of pointing at target chamber center without impact is shown based on the 1w and 3w beam footprints. The limit based on 1w applies for all cases. The limit based on 3w applies for cases where the 3w beam may propagate past target chamber center (such as for a gas bag or a point projection fiber backlighter).

Beam cone interaction	Affected quads (beam port numbers)	Nearest approach of 1w (at wall)	Max offset pointing at TCC in azimuth – limit based on 1w at wall	Nearest approach of 3w (at wall)	Max offset pointing at TCC in azimuth – limit based on 3w at wall
23.5° - 23.5°	1-72 2-69 3-70 4-71	42 mm	26 mm	20 mm	12 mm
44.5° – 44.5°	9-61 10-62 11-63 12-64 13-57 14-58 15-59 16-60	15 mm	9 mm	-5 mm *overlaps*	n/a
44.5° – 50°	9-53 18-62 11-55 20-64 13-49 22-58 15-51 24-60	39 mm	24 mm	20 mm	12 mm
50° – 50°	17-54 19-56 21-50 23-52 22-51 24-53 18-55 20-49	61 mm 80 mm	38 mm 50 mm	41 mm 60 mm	25 mm 37 mm

Table 2: Equivalent beamlets lost per quad due to aperture requirements based on 30 mm and 50 mm range of pointing. These are shown based on propagating the focussed 3w beam past chamber center since that is the more restrictive case.

Beam cone interaction	Affected quads (beam port numbers)	Equivalent beamlets lost* due to aperture in PAM for 30 mm pointing (3w) (Approx)	Equivalent beamlets lost* due to aperture in PAM for 50 mm pointing (3w) (Approx)	Proposed solution for offset pointing
23.5° - 23.5°	1-72 2-69 3-70 4-71	0.36	1.00	- Aperture to allow 30 mm. - Turn beam off for 50 mm
44.5° - 44.5°	9-61 10-62 11-63 12-64 13-57 14-58 15-59 16-60	0.96	1.60	- Aperture for pointing at TCC when beam propagates past TCC - Turn off 1 beam for offset pointing
44.5° - 50°	9-53 18-62 11-55 20-64 13-49 22-58 15-51 24-60	0.4	1.08	- Aperture to allow 30 mm - Turn 1 beam off for up to 50 mm
50° - 50°	17-54 19-56 21-50 23-52 22-51 24-53 18-55 20-49	0.32 0.0	0.84 0.48	- Aperture to allow 30 mm - Turn off 1 beam for up to 50 mm - Aperture to allow 30 mm** - Turn off 1 beam for up to 50 mm

* This is out of 4 beams total since the aperture located before the 1:4 split. When this exceeds 1.0, it makes more sense to just turn off the single beam causing the interference.

** Fractional beam area lost due to 50 mm pointing is small, but this is in addition to loss from pointing in opposite direction and the impact on other beam quads. We propose defining the aperture to allow only 30 mm range of pointing to limit the loss introduced with a dual purpose aperture.

Table 3: Summary of alignment range limits and required aperture for backlighter pointing. This table includes the impact of some beams on 2 different near-opposite FOA ports.

Affected Quad	FOA Port No.	Near-opposing FOA ports impacted	Azimuthal direction (x) for beam pointing that affects the near opposite port listed	How to accommodate beam pointing
Q11T	17	54	-	See note 1
Q12T	10	62	-	See note 3
Q13T	5			No impact
Q14T	9	61, 53	-, +	See note 5
Q15T	1	72	-	See note 1
Q16T	18	55, 62	-, +	See note 7
Q21T	24	53, 60	-, +	See note 7
Q22T	16	60, 52	-, +	See note 3
Q23T	23	52	-	See note 1
Q24T	4	71	-	See note 1
Q25T	15	59, 51	-, +	See note 5
Q26T	8			No impact
Q31T	22	51, 58	-, +	See note 7
Q32T	14	58	-	See note 3
Q33T	3	70	-	See note 1
Q34T	21	50	-	See note 1
Q35T	13	57, 49	-, +	See note 5
Q36T	7			No impact
Q41T	6			No impact
Q42T	2	69	-	See note 1
Q43T	11	63, 55	-, +	See note 5
Q44T	20	49, 64	-, +	See note 7
Q45T	12	64	-	See note 3
Q46T	19	56	-	See note 1

Affected Quad	FOA Port No.	Near-opposing FOA ports impacted	Azimuthal direction (x) for beam pointing that affects the near opposite port listed	How to accommodate beam pointing
Q11B	50	21	+	See note 2
Q12B	58	22, 14	-, +	See note 6
Q13B	49	13, 20	-, +	See note 8
Q14B	57	13	+	See note 4
Q15B	69	2	+	See note 2
Q16B	65			No impact
Q21B	68			No impact
Q22B	64	20, 12	-, +	See note 6
Q23B	56	19	+	See note 2
Q24B	72	1	+	See note 2
Q25B	63	11	+	See note 4
Q26B	55	11, 18	-, +	See note 8
Q31B	67			No impact
Q32B	62	18, 10	-, +	See note 6
Q33B	71	4	+	See note 2
Q34B	54	17	+	See note 2
Q35B	61	9	+	See note 4
Q36B	53	9, 24	-, +	See note 8
Q41B	51	15, 22	-, +	See note 8
Q42B	70	3	+	See note 2
Q43B	59	15	+	See note 4
Q44B	66			No impact
Q45B	60	24, 16	-, +	See note 6
Q46B	52	23	+	See note 2

Table 3 (cont'd): Notes for offset beam pointing:

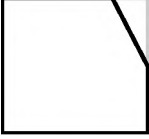
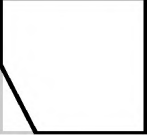
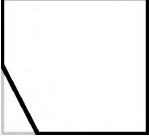
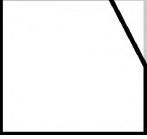
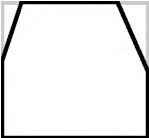
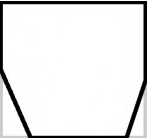
<p>1 - Approx aperture shape:</p>  <p>- Install aperture for beam pointing in $-x$ up to 30 mm. - Remove aperture and turn off beam Q1 in quad for pointing in $-x$ greater than 30 mm.</p>	<p>2 - Approx aperture shape:</p>  <p>- Install aperture for beam pointing in $+x$ up to 30 mm. - Remove aperture and turn off beam Q3 in quad for pointing in $+x$ greater than 30 mm.</p>
<p>3 - Aperture required only when beam pointed at TCC propagates past center. Turn off beam Q1 for all pointing in $-x$ direction</p>	<p>4 - Aperture required only when beam pointed at TCC propagates past center. Turn off beam Q3 for pointing in $+x$ direction.</p>
<p>5 - No aperture required for pointing in $-x$ direction. Turn off beam Q1 for all offset pointing in this direction. - Aperture required for pointing in $+x$ direction. Approx aperture shape:</p>  <p>- Install aperture for beam pointing in $+x$ up to 30 mm. - Remove aperture and turn off beam Q3 for pointing in $+x$ greater than 30 mm.</p>	<p>6 - No aperture required for pointing in $+x$ direction. Turn off beam Q3 for all offset pointing in this direction. - Aperture required for pointing in $-x$ direction. Approx aperture shape:</p>  <p>- Install aperture for beam pointing in $-x$ up to 30 mm. - Remove aperture and turn off beam Q1 for pointing in $-x$ greater than 30 mm.</p>
<p>7 - Aperture required for pointing in $+/-x$ directions. Approx aperture shape:</p>  <p>- Install aperture for beam pointing in $+/-x$ up to 30 mm. - Remove aperture and turn off beam Q2(Q1) for pointing in $+(-) x$ greater than 30 mm.</p>	<p>8 - Aperture required for pointing in $+/-x$ directions. Approx aperture shape:</p>  <p>- Install aperture for beam pointing in $+/-x$ up to 30 mm. - Remove aperture and turn off beam Q3(Q4) for pointing in $+(-) x$ greater than 30 mm.</p>

Figure 1: Projection of the top half of the NIF target chamber showing the top beam quads entering through the FOA apertures in the first wall and the 1w unconverted light footprint from the bottom quads incident on the first wall.

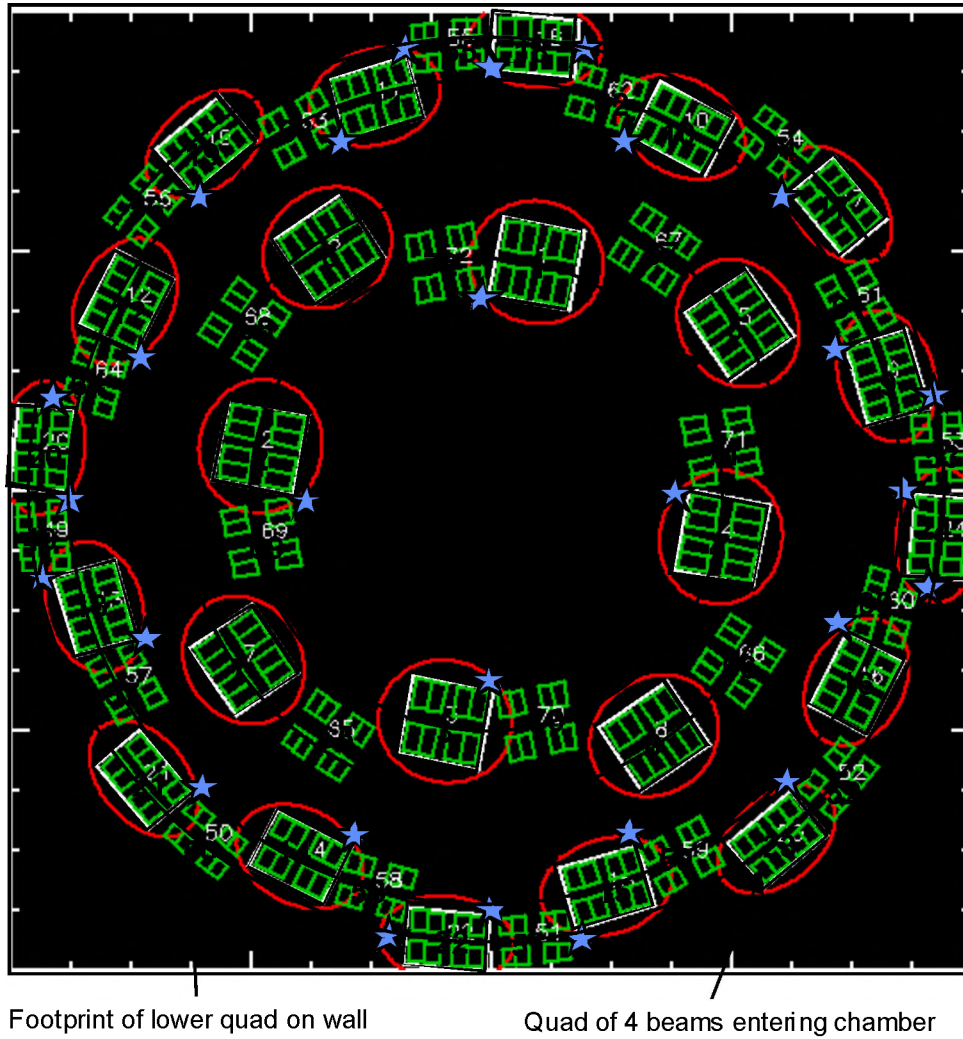
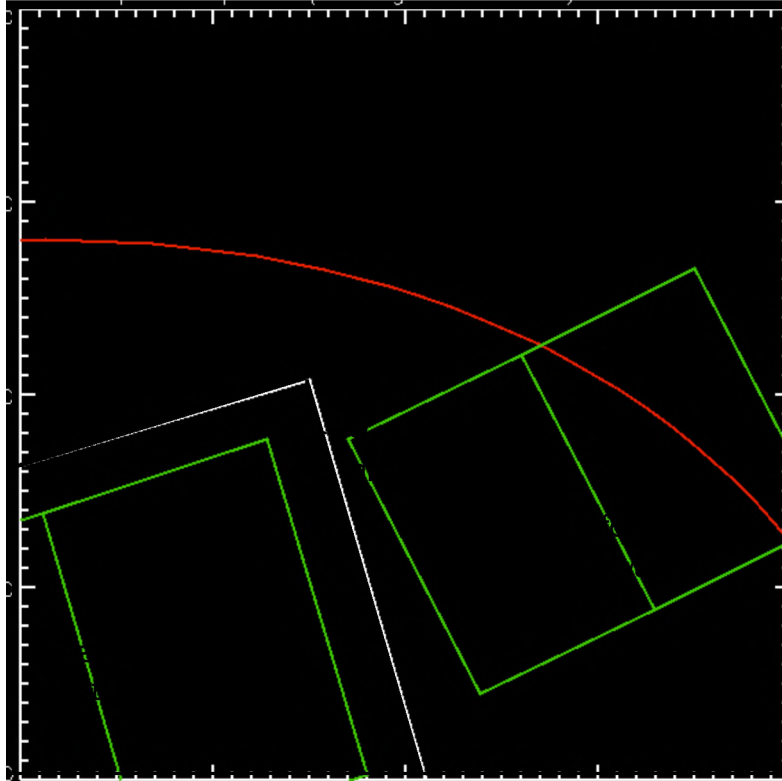


Figure 2: Close-up view of the proximity of one quad of beams with a near-opposite FOA.

a) proximity of 1w footprint with near-opposite port



b) proximity of 3w footprint with near-opposite port

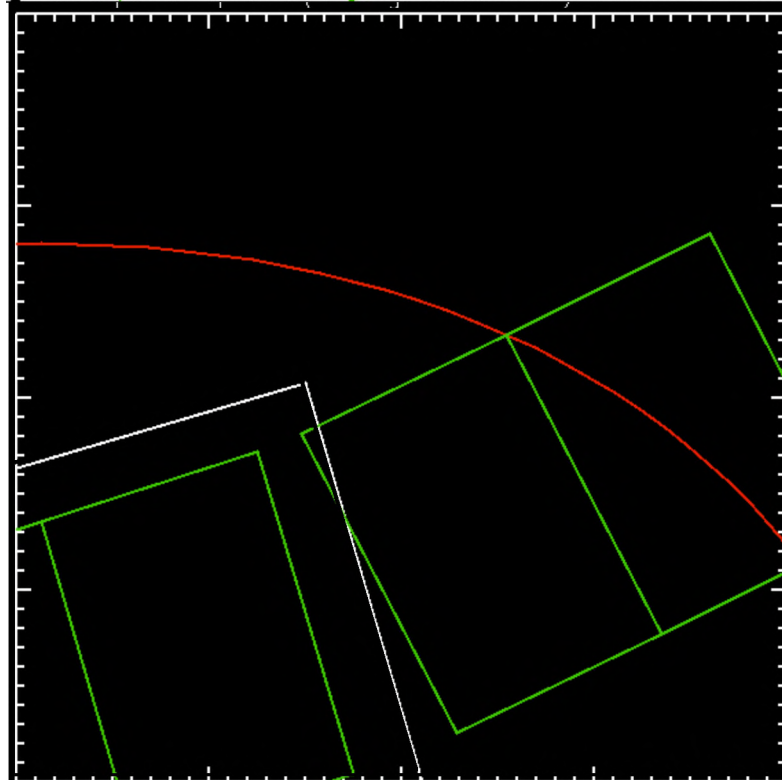
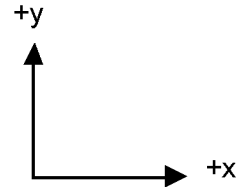
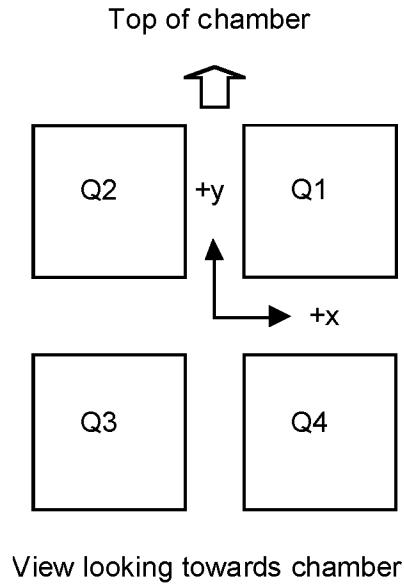


Figure 3: Diagram showing the coordinate system assumed for specifying beam pointing direction and beamlet identification (from NIF Drawing AAA96-104900).

a) Coordinates for a quad of beams

b) Beam pointing coordinates



Alignment directions as viewed along beamline toward chamber center

