



SANDIA PULSED REACTOR FACILITY/CRITICAL EXPERIMENT Overview and Recent Experiments

National Organization of Test, Research &
Training Reactors

2015 Meeting

Brewster, MA

October 5, 2015

Gary A. Harms, John T. Ford, Rafe D. Campbell, and
Allison D. Miller



*Exceptional
service
in the
national
interest*



Sandia National Laboratories is a multi-program laboratory managed and operated by Sandia Corporation, a wholly owned subsidiary of Lockheed Martin Corporation, for the U.S. Department of Energy's National Nuclear Security Administration under contract DE-AC04-94AL85000. SAND NO. 2011-XXXXP

Topics

- CX Overview

- Account of work at the Sandia Critical Experiments (SCX) reactor completed over past couple of years
 - Evaluated in LEU-COMP-THERM-096 in the International Handbook of Evaluated Criticality Safety Benchmark Experiments
 - Approaches on Moderator Level
 - Supported by the DOE Nuclear Criticality Safety Program (NCSP)

- Titanium
 - Reactivity effects and worth of Ti
 - Savannah River process – monosodium titanate

CX - Overview



CX – Cross Section

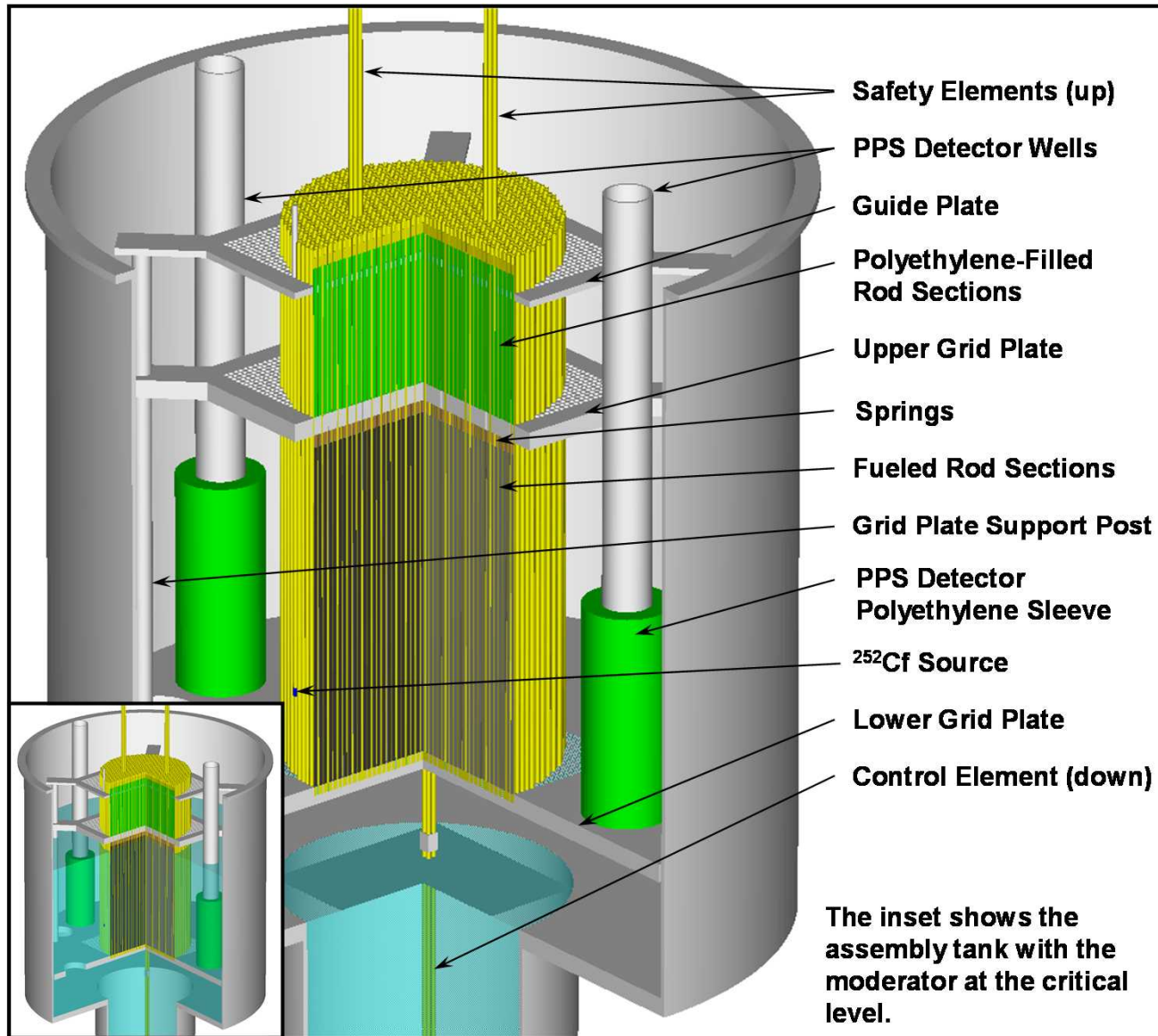

Reflection – Full vs. Partial

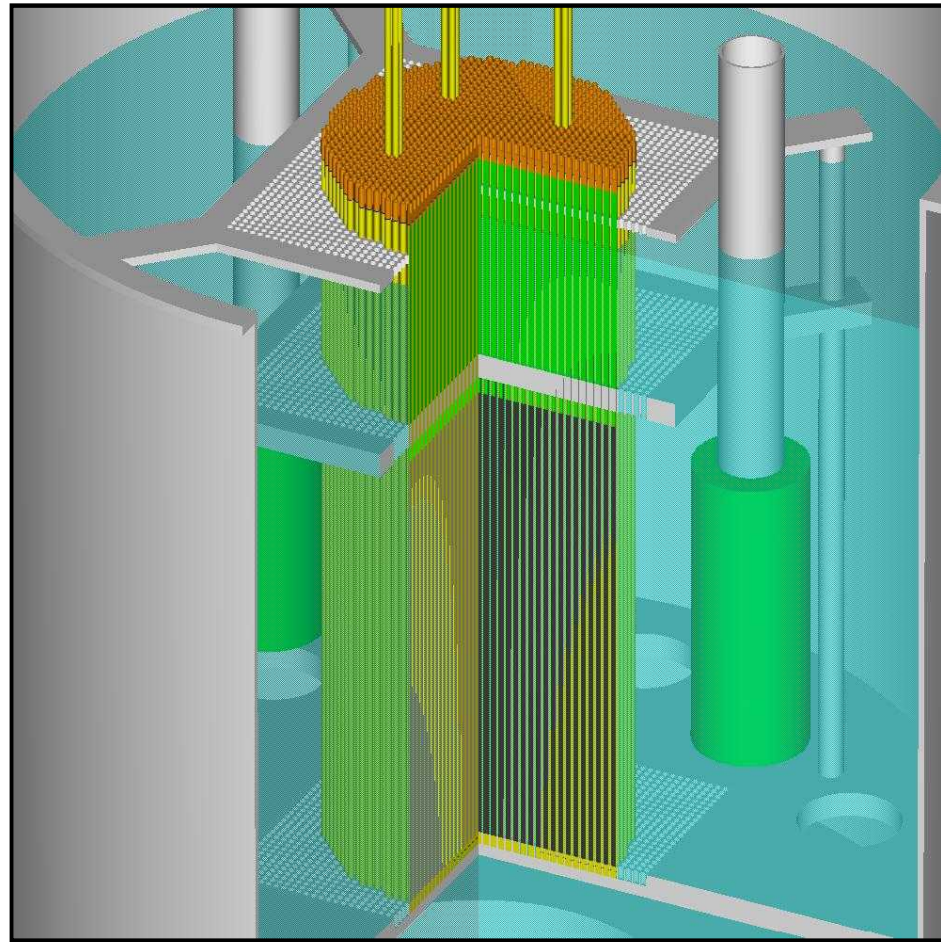

Fully-Reflected

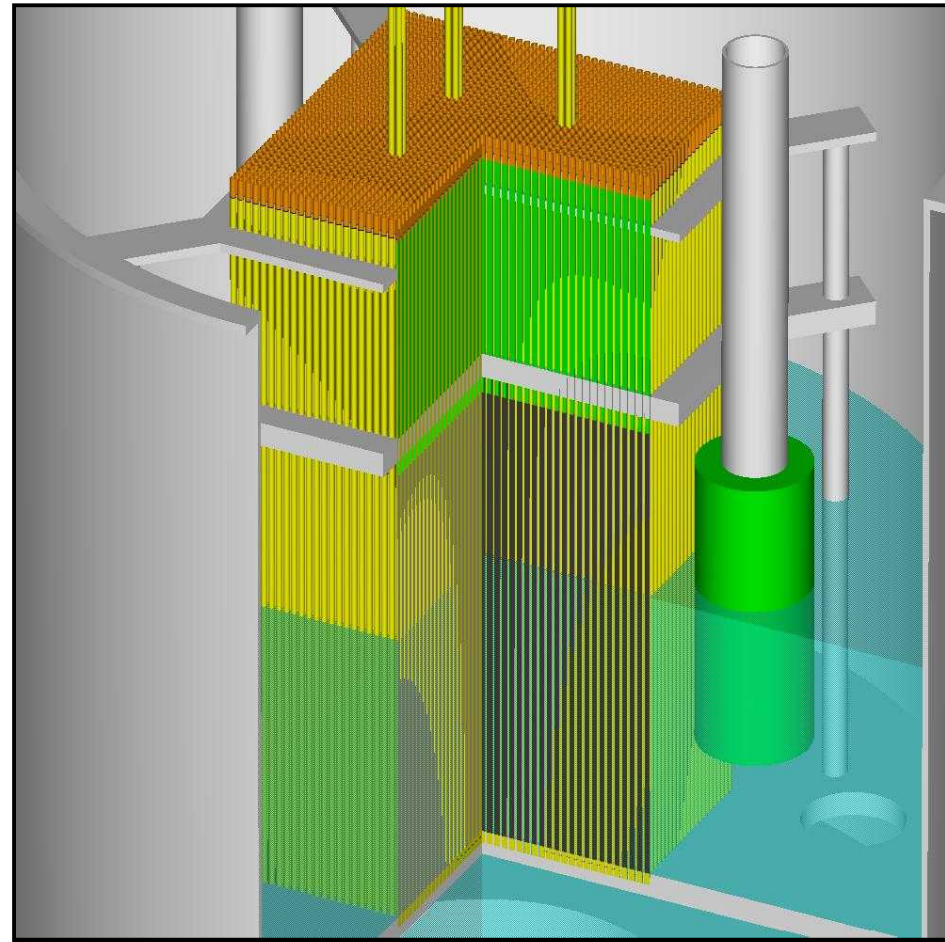

Partially-Reflected

CX – Inside Core Tank

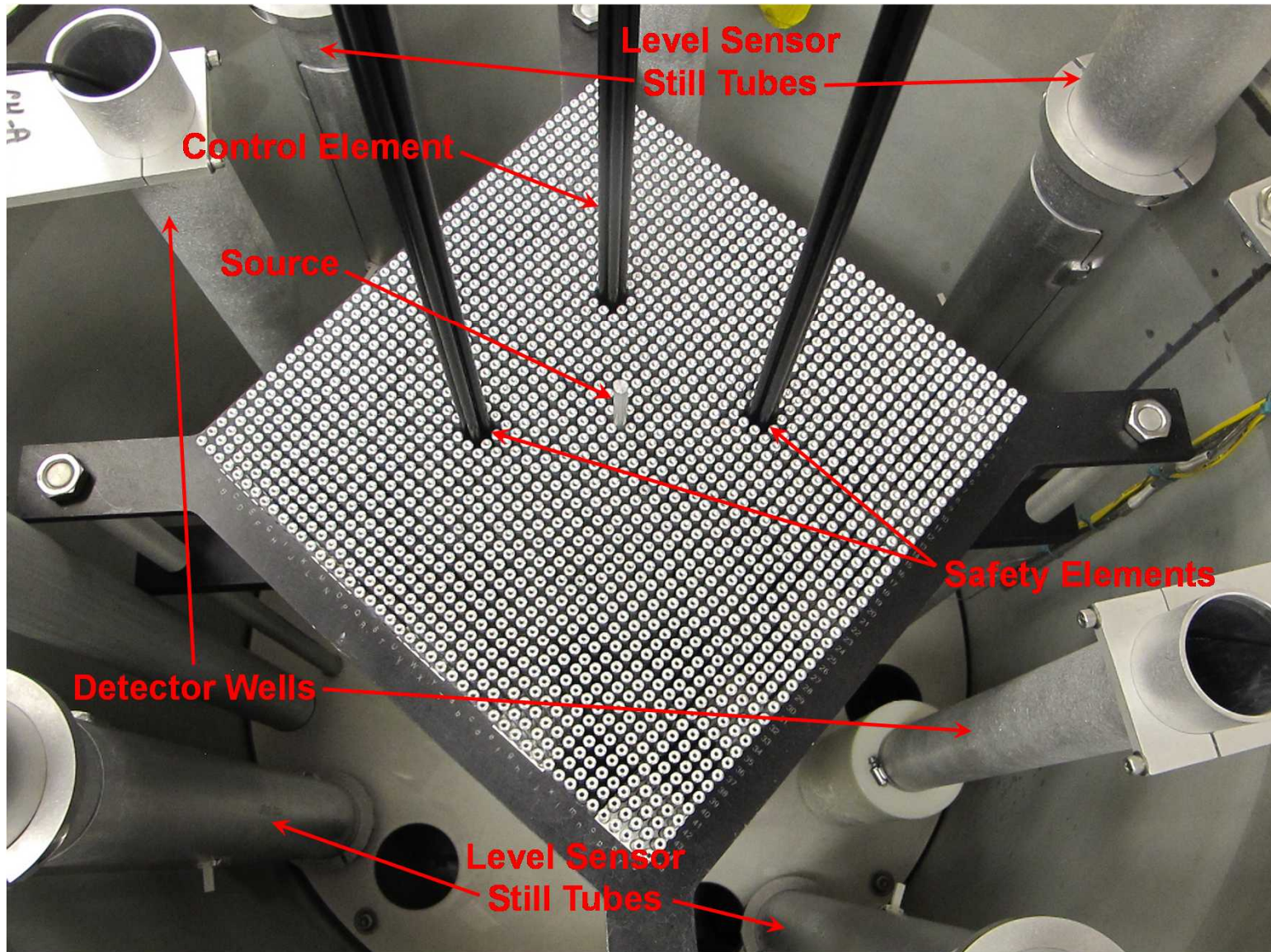

Standpipes – Water Level Control

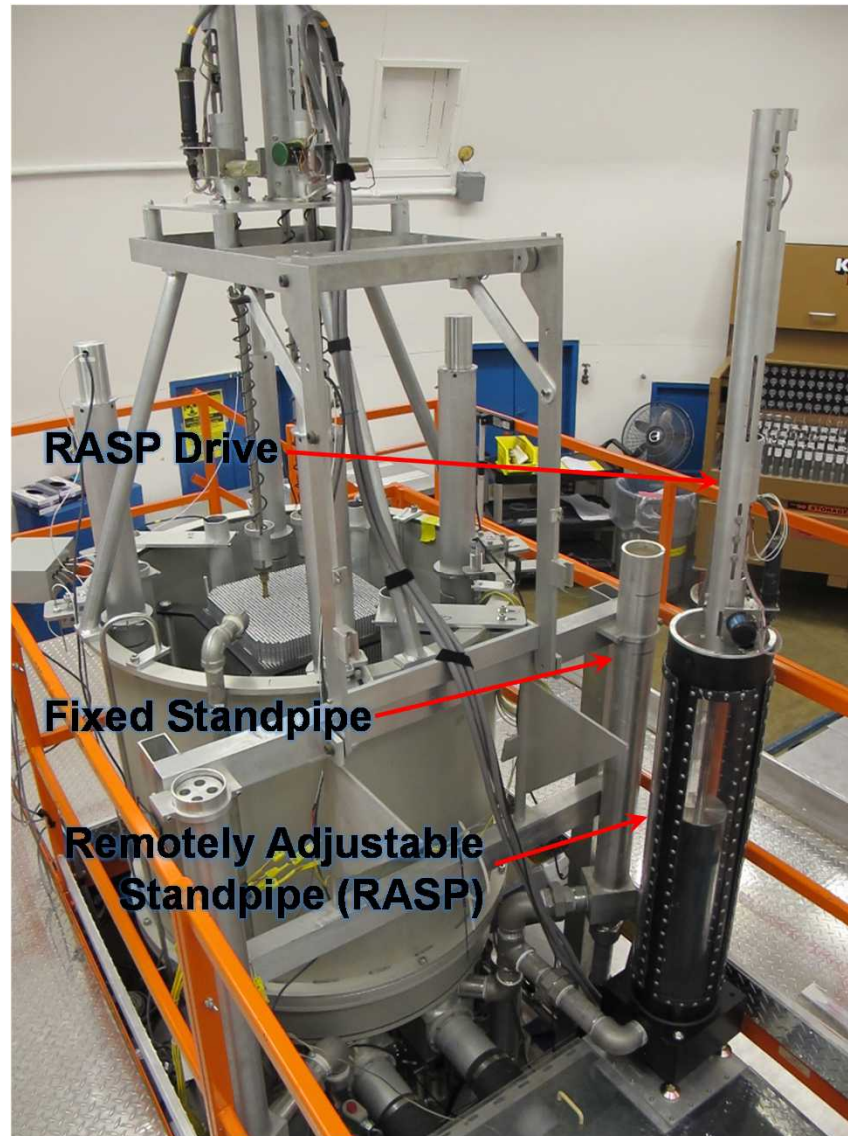

Level Measurement – Four “Ultra”sonic Detectors

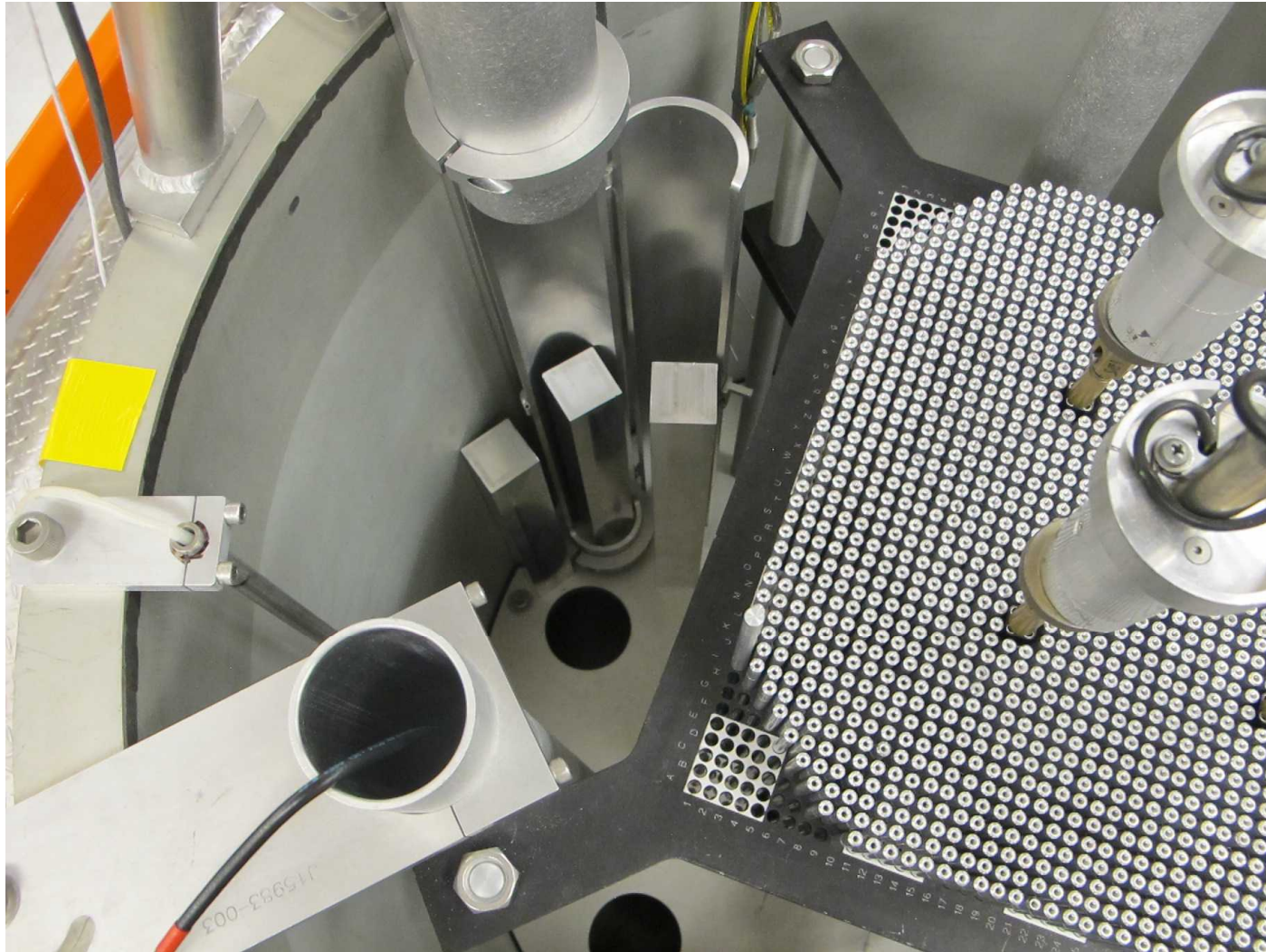

19 Cases – APPROACHES ON MODERATOR LEVEL

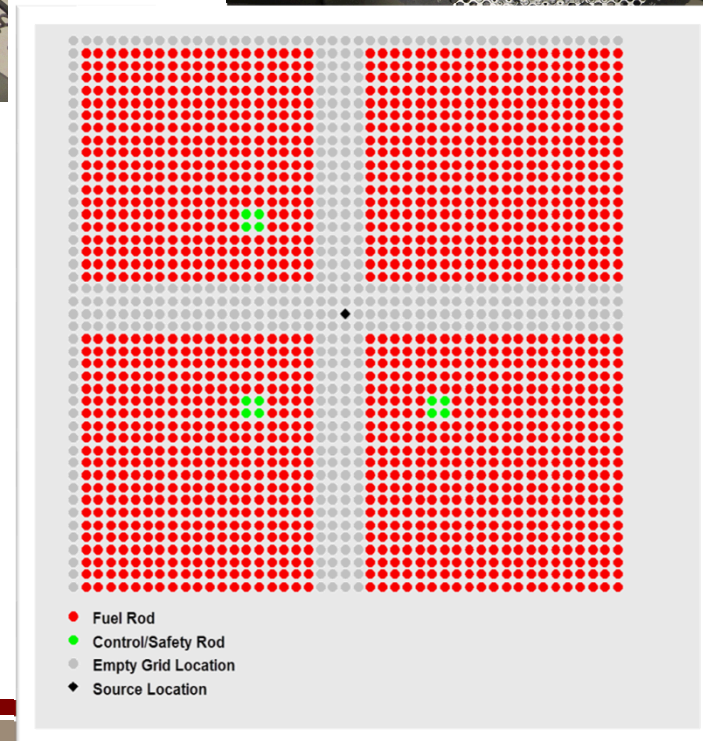
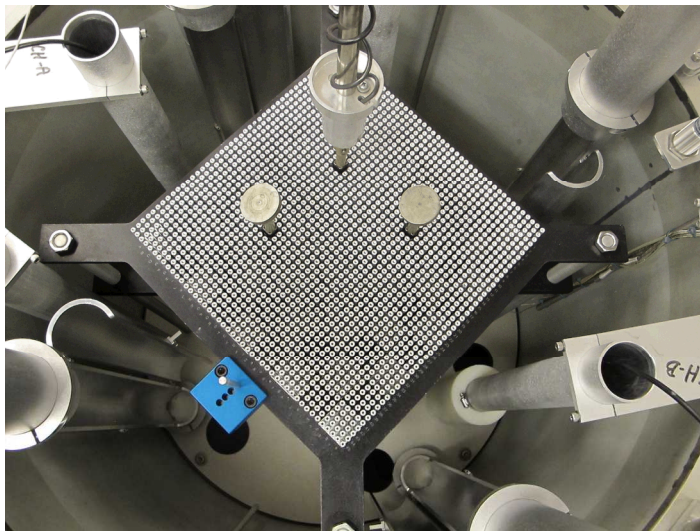
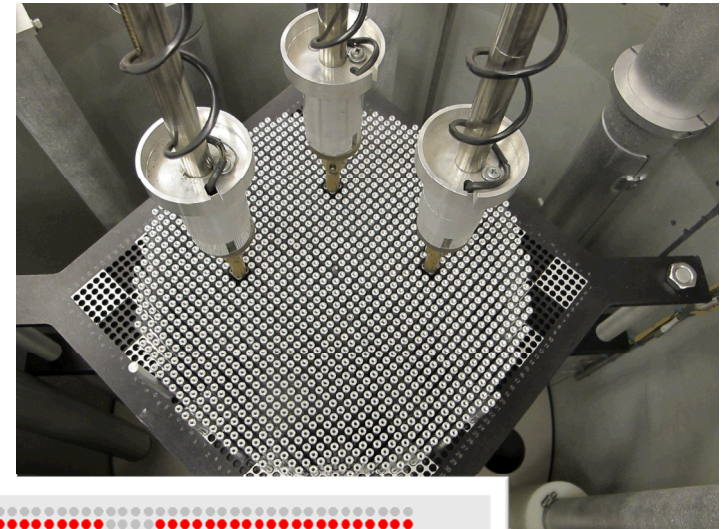
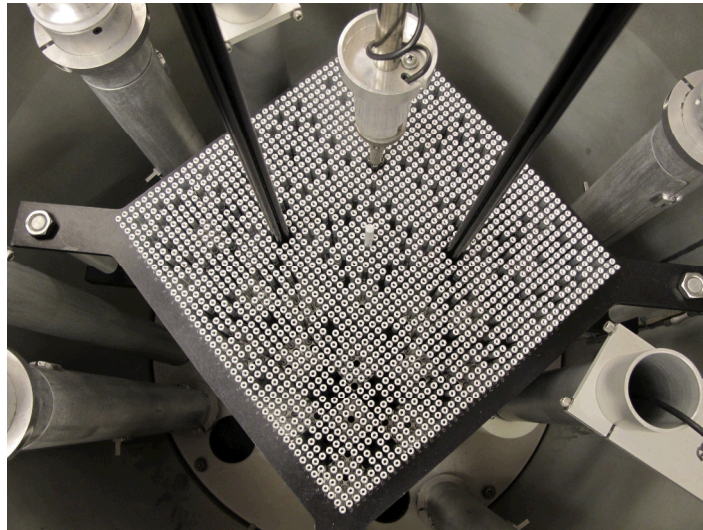

Reactivity Worth - Titanium

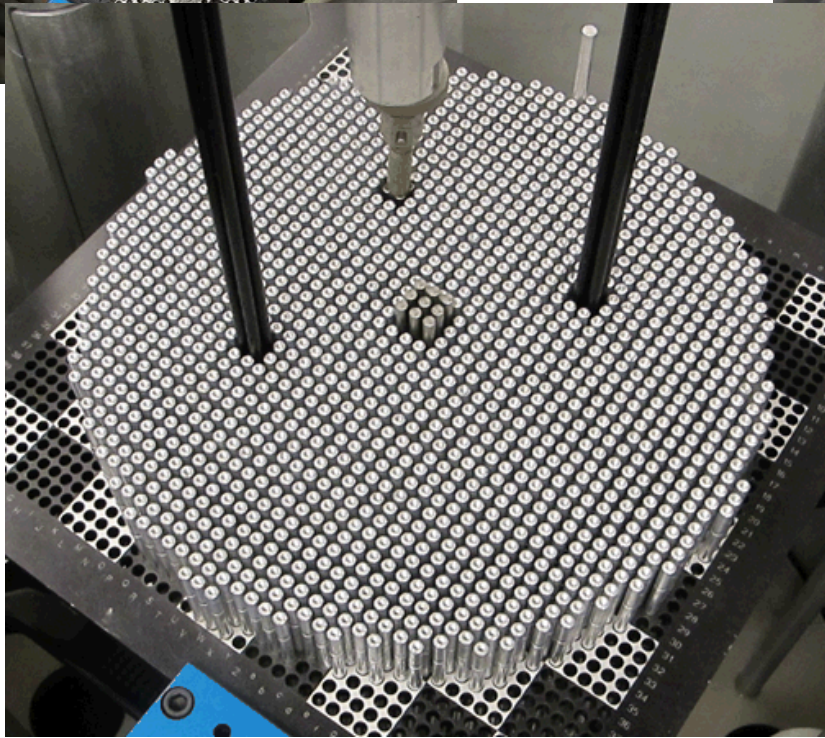
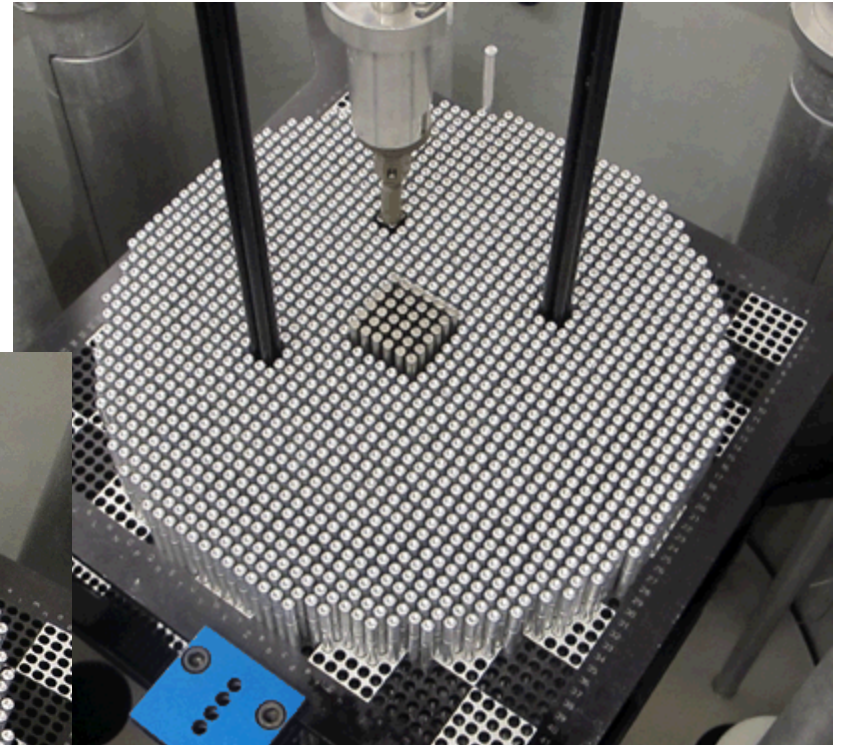
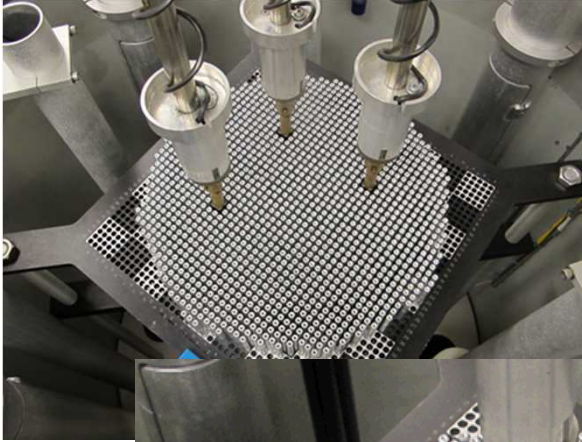

Fully Reflected

Reactivity Worth - Titanium

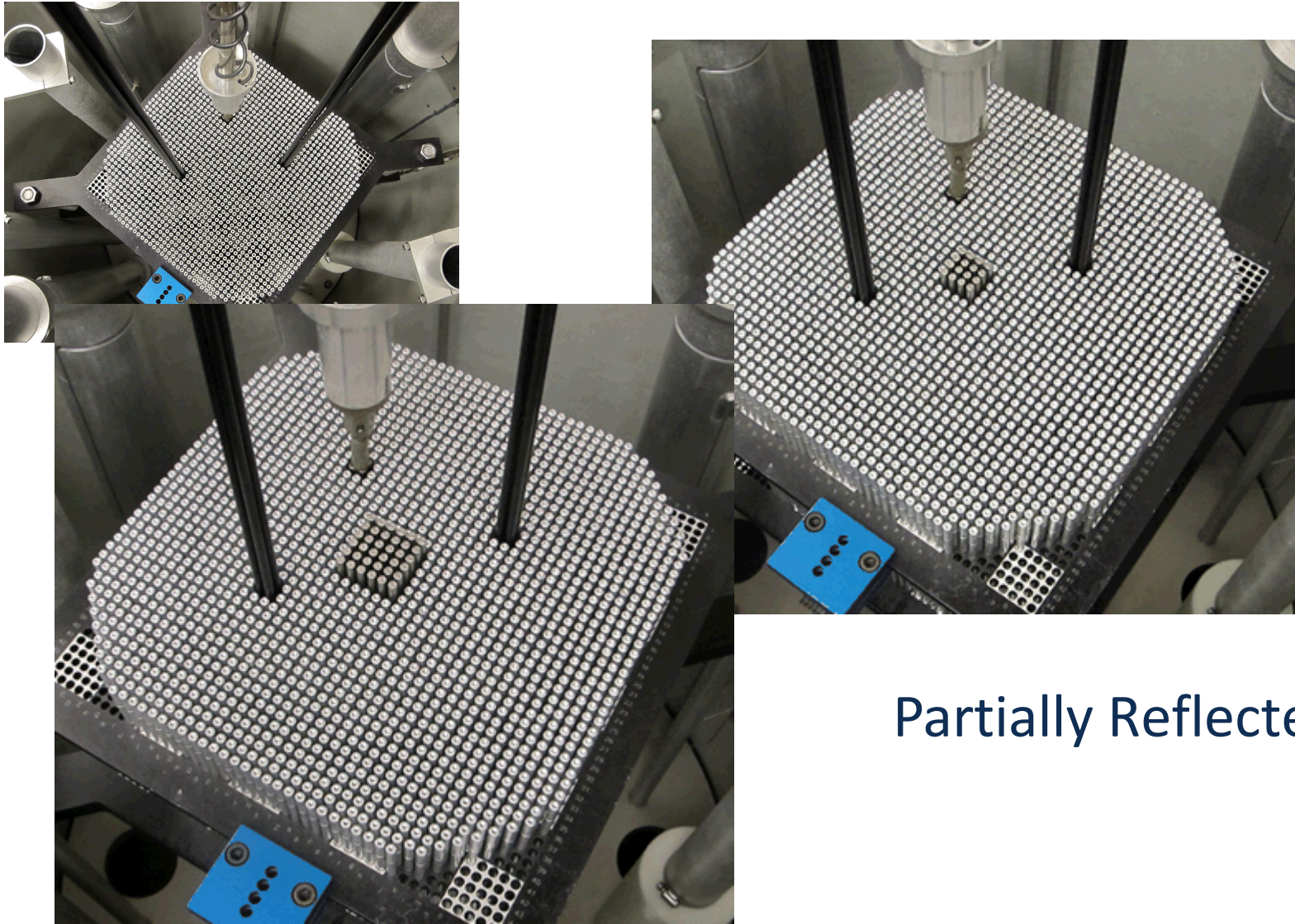

Partially Reflected

Planned Experiments - Titanium

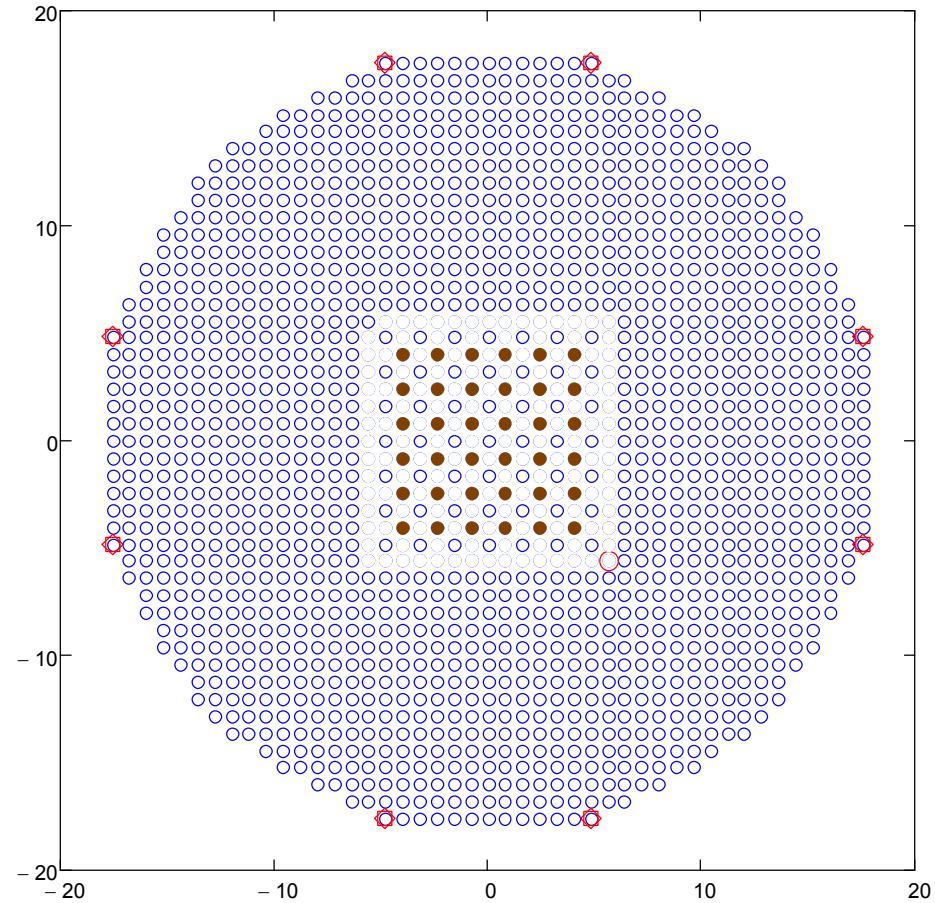
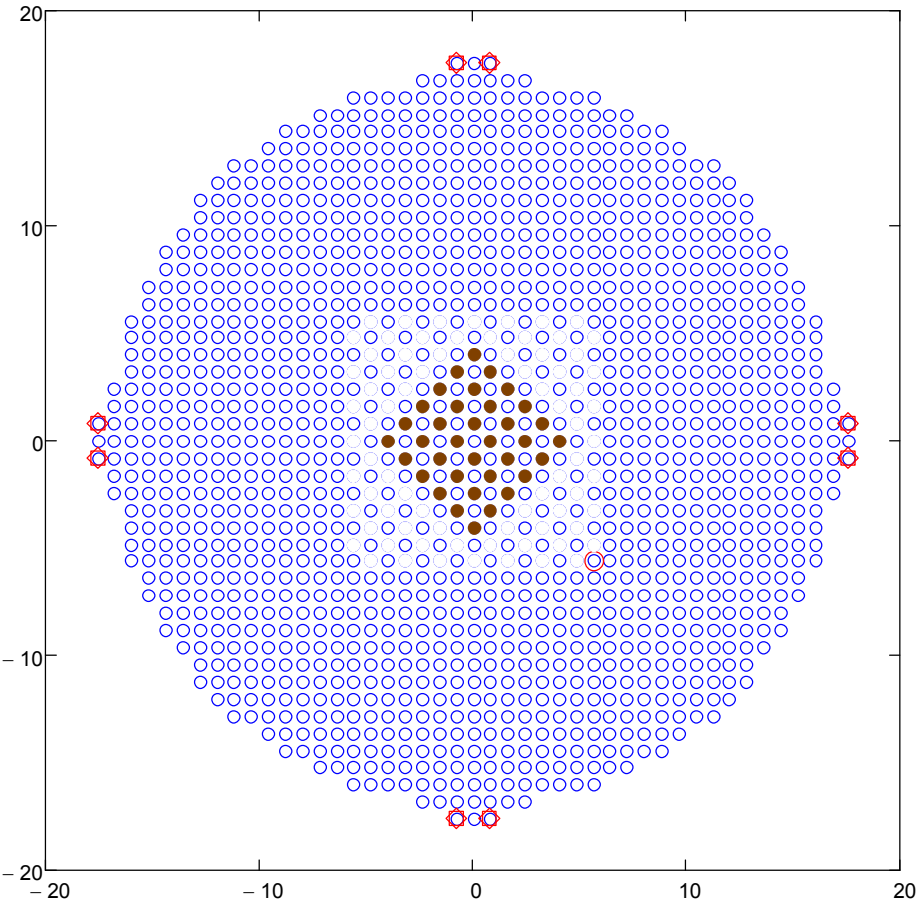

SPRF/CX – Critical Experiments

