

# SAND REPORT

SAND2011-2498  
Unlimited Release  
Printed May 2011

---

## Xyce™ Parallel Electronic Simulator

---

### Reference Guide, Version 5.2

Eric R. Keiter, Ting Mei, Thomas V. Russo, Eric L. Rankin, Roger P. Pawlowski,  
Richard L. Schiek, Keith R. Santarelli, Todd S. Coffey, Heidi K. Thornquist,  
Christina E. Warrender, Deborah A. Fixel

Prepared by  
Sandia National Laboratories  
Albuquerque, New Mexico 87185 and Livermore, California 94550

Sandia National Laboratories is a multi-program laboratory managed and operated by Sandia Corporation,  
a wholly owned subsidiary of Lockheed Martin Corporation, for the U.S. Department of Energy's  
National Nuclear Security Administration under contract DE-AC04-94AL85000.

Approved for public release; further dissemination unlimited.



**Sandia National Laboratories**

Issued by Sandia National Laboratories, operated for the United States Department of Energy by Sandia Corporation.

**NOTICE:** This report was prepared as an account of work sponsored by an agency of the United States Government. Neither the United States Government, nor any agency thereof, nor any of their employees, nor any of their contractors, subcontractors, or their employees, make any warranty, express or implied, or assume any legal liability or responsibility for the accuracy, completeness, or usefulness of any information, apparatus, product, or process disclosed, or represent that its use would not infringe privately owned rights. Reference herein to any specific commercial product, process, or service by trade name, trademark, manufacturer, or otherwise, does not necessarily constitute or imply its endorsement, recommendation, or favoring by the United States Government, any agency thereof, or any of their contractors or subcontractors. The views and opinions expressed herein do not necessarily state or reflect those of the United States Government, any agency thereof, or any of their contractors.

Printed in the United States of America. This report has been reproduced directly from the best available copy.

Available to DOE and DOE contractors from  
U.S. Department of Energy  
Office of Scientific and Technical Information  
P.O. Box 62  
Oak Ridge, TN 37831

Telephone: (865) 576-8401  
Facsimile: (865) 576-5728  
E-Mail: [reports@adonis.osti.gov](mailto:reports@adonis.osti.gov)  
Online ordering: <http://www.doe.gov/bridge>

Available to the public from  
U.S. Department of Commerce  
National Technical Information Service  
5285 Port Royal Rd  
Springfield, VA 22161

Telephone: (800) 553-6847  
Facsimile: (703) 605-6900  
E-Mail: [orders@ntis.fedworld.gov](mailto:orders@ntis.fedworld.gov)  
Online ordering: <http://www.ntis.gov/ordering.htm>



SAND2011-2498  
Unlimited Release  
Printed May 2011

---

# **Xyce™ Parallel Electronic Simulator**

## **Reference Guide, Version 5.2**

Eric R. Keiter, Ting Mei, Thomas V. Russo, Eric L. Rankin,  
Richard L. Schiek, and Heidi K. Thornquist  
Electrical Systems Modeling

Deborah A. Fixel  
Advanced Device Technologies

Todd S. Coffey  
Computational Simulation Infrastructure

Roger P. Pawlowski  
Multiphysics Simulation Technology

Keith R. Santarelli

Christina E. Warrender  
Cognitive Modeling

Sandia National Laboratories  
P.O. Box 5800  
Mail Stop 0316  
Albuquerque, NM 87185-0316

May 13, 2011

## **Abstract**

This document is a reference guide to the **Xyce** Parallel Electronic Simulator, and is a companion document to the **Xyce** Users' Guide. The focus of this document is (to the extent possible) exhaustively list device parameters, solver options, parser options, and other usage details of **Xyce**. This document is *not* intended to be a tutorial. Users who are new to circuit simulation are better served by the **Xyce** Users' Guide.

## Acknowledgements

The authors would like to acknowledge the entire Sandia National Laboratories HPEMS (High Performance Electrical Modeling and Simulation) team, including Steve Wix, Carolyn Bogdan, Regina Schells, Ken Marx, Steve Brandon and Bill Ballard, for their support on this project.

## Trademarks

The information herein is subject to change without notice.

Copyright © 2002-2011 Sandia Corporation. All rights reserved.

**Xyce™** Electronic Simulator and **Xyce™** trademarks of Sandia Corporation.

Portions of the **Xyce™** code are:

Copyright © 2002, The Regents of the University of California.

Produced at the Lawrence Livermore National Laboratory.

Written by Alan Hindmarsh, Allan Taylor, Radu Serban.

UCRL-CODE-2002-59

All rights reserved.

Orcad, Orcad Capture, PSpice and Probe are registered trademarks of Cadence Design Systems, Inc.

Silicon Graphics, the Silicon Graphics logo and IRIX are registered trademarks of Silicon Graphics, Inc.

Microsoft, Windows and Windows 2000 are registered trademark of Microsoft Corporation.

Solaris and UltraSPARC are registered trademarks of Sun Microsystems Corporation.

Medici, DaVinci and Taurus are registered trademarks of Synopsys Corporation.

HP and Alpha are registered trademarks of Hewlett-Packard company.

Amtec and TecPlot are trademarks of Amtec Engineering, Inc.

**Xyce's** expression library is based on that inside Spice 3F5 developed by the EECS Department at the University of California.

The EKV3 MOSFET model was developed by the EKV Team of the Electronics Laboratory-TUC of the Technical University of Crete.

All other trademarks are property of their respective owners.

## Contacts

Bug Reports

<http://joseki.sandia.gov/bugzilla>  
<http://charleston.sandia.gov/bugzilla>

World Wide Web

<http://xyce.sandia.gov>  
<http://charleston.sandia.gov/xyce>

Email

[xyce-support@sandia.gov](mailto:xyce-support@sandia.gov)



**Sandia National Laboratories**

# Contents

|  |           |
|--|-----------|
| <b>1. Introduction</b>                                   | <b>13</b> |
| 1.1 Overview   | 14        |
| 1.2 How to Use this Guide                                | 14        |
| 1.3 Third Party License Information                      | 16        |
| <b>2. Netlist Reference</b>                              | <b>19</b> |
| 2.1 Netlist Commands                                     | 20        |
| DC Sweep Analysis  | 20        |
| STEP Parametric Analysis                                 | 23        |
| Transient Analysis                                       | 27        |
| Harmonic Balance Analysis                                | 30        |
| Multi-Time Partial Differential Equation (MPDE) Analysis | 31        |
| Device Modeling  | 32        |
| Output Control   | 36        |
| Netlist Processing                                       | 43        |
| Miscellaneous Commands                                   | 45        |
| .OPTIONS Statements                                      | 46        |
| .PREPROCESS Statements                                   | 69        |
| 2.2 Analog Devices                                       | 72        |
| Voltage Nodes  | 75        |
| Capacitor  | 76        |
| Inductor   | 79        |
| Mutual Inductors   | 81        |
| Resistor   | 85        |
| Diode  | 89        |
| Independent Current Source                               | 95        |
| Independent Voltage Source                               | 99        |
| Voltage Controlled Voltage Source                        | 100       |
| Current Controlled Current Source                        | 101       |
| Current Controlled Voltage Source                        | 102       |

|   |            |
|---|------------|
| Voltage Controlled Current Source . . . . .                         | 103        |
| Nonlinear Dependent Source . . . . .                                | 104        |
| Bipolar Junction Transistor (BJT) . . . . .                         | 105        |
| Junction Field-Effect Transistor (JFET) . . . . .                   | 116        |
| Metal-Semiconductor FET (MESFET) . . . . .                          | 119        |
| MOS Field Effect Transistor (MOSFET) . . . . .                      | 122        |
| Voltage- or Current-controlled Switch . . . . .                     | 254        |
| Generic Switch . . . . .  | 257        |
| Lossless (Ideal) Transmission Line . . . . .                        | 258        |
| Behavioral Digital Devices . . . . .                                | 259        |
| Accelerated mass . . . . .  | 263        |
| Subcircuit . . . . .  | 264        |
| 2.3 TCAD Devices . . . . .  | 265        |
| TCAD Device Parameters . . . . .                                    | 266        |
| Physical Models . . . . .   | 271        |
| Mobility Models . . . . .   | 274        |
| <b>3. Command Line Arguments</b>                                    | <b>291</b> |
| <b>4. Runtime Environment</b>                                       | <b>293</b> |
| Running <b>Xyce</b> in Serial . . . . .                             | 293        |
| Running <b>Xyce</b> in Parallel . . . . .                           | 293        |
| Running <b>Xyce</b> on Sandia HPC Platforms . . . . .               | 293        |
| <b>5. Setting Convergence Parameters for Xyce</b>                   | <b>295</b> |
| Adjusting Transient Analysis Error Tolerances . . . . .             | 295        |
| Adjusting Nonlinear Solver Parameters (in transient mode) . . . . . | 296        |
| <b>6. Quick Reference for Orcad PSpice Users</b>                    | <b>299</b> |
| GUI Support . . . . .   | 299        |
| Command Line Options . . . . .                                      | 299        |
| Device Support . . . . .  | 299        |
| Netlist Support . . . . .   | 299        |
| Converting PSpice ABM Models for Use in <b>Xyce</b> . . . . .       | 300        |
| Usage of .STEP Analysis . . . . .                                   | 301        |
| Other differences . . . . .   | 302        |
| <b>7. Quick Reference for ChileSPICE Users</b>                      | <b>305</b> |



|   |            |
|---|------------|
| <b>8. Quick Reference for Microsoft Windows Users</b> | <b>309</b> |
| <b>9. Rawfile Format</b>                              | <b>311</b> |
| Ascii Format .....                                    | 311        |
| Binary Format .....                                   | 311        |
| Special Notes .....                                   | 311        |



## Tables

|      |  |     |
|------|--|-----|
| 1.1  | <b>Xyce</b> typographical conventions. . . . .   | 15  |
| 2.1  | Options for Device Package . . . . .   | 49  |
| 2.2  | Options for Time Integration Package. . . . .  | 55  |
| 2.3  | Options for MPDE Package. . . . .  | 57  |
| 2.4  | Options for HB. . . . .  | 57  |
| 2.5  | Options for Nonlinear Solver Package. . . . .  | 62  |
| 2.6  | Options for Continuation and Bifurcation Tracking Package. . . . .                                   | 63  |
| 2.7  | Options for Linear Solver Package. . . . .   | 66  |
| 2.8  | List of keywords and device types which can be used in a .PREPROCESS REMOVEUNUSED statement. . . . . | 70  |
| 2.9  | Analog Device Quick Reference. . . . .   | 74  |
| 2.10 | Capacitor Device Parameters. . . . .   | 77  |
| 2.11 | Capacitor Model Parameters. . . . .  | 78  |
| 2.12 | Inductor Model Parameters. . . . .   | 80  |
| 2.13 | Nonlinear Mutual Inductor Device Model Parameters. . . . .   | 83  |
| 2.14 | Resistor Device Parameters. . . . .  | 86  |
| 2.15 | Resistor Model Parameters. . . . .   | 86  |
| 2.16 | Resistor Device Instance Parameters. . . . .   | 87  |
| 2.17 | Resistor Device Model Parameters. . . . .  | 88  |
| 2.18 | Diode Device Parameters. . . . .   | 90  |
| 2.19 | Diode Model Parameters. . . . .  | 91  |
| 2.20 | BJT Model Parameters. . . . .  | 109 |
| 2.21 | VBIC Device Model Parameters. . . . .  | 112 |
| 2.22 | JFET Device Parameters. . . . .  | 117 |
| 2.23 | JFET Model Parameters. . . . .   | 118 |
| 2.24 | MESFET Device Parameters. . . . .  | 120 |
| 2.25 | MESFET Model Parameters. . . . .   | 121 |
| 2.26 | MOSFET level 1 Device Model Parameters. . . . .  | 133 |
| 2.27 | MOSFET level 2 Device Model Parameters. . . . .  | 135 |
| 2.28 | MOSFET level 3 Device Model Parameters. . . . .  | 137 |

|  |     |
|--|-----|
| 2.29 MOSFET level 6 Device Model Parameters. . . . .             | 139 |
| 2.30 BSIM3 Device Model Parameters. . . . .                      | 154 |
| 2.31 BSIM3 SOI Device Model Parameters. . . . .                  | 178 |
| 2.32 BSIM4 Device Instance Parameters. . . . .                   | 180 |
| 2.33 BSIM4 Device Model Parameters. . . . .                      | 208 |
| 2.34 Power MOSFET Device Parameters. . . . .                     | 208 |
| 2.35 Power MOSFET Model Parameters. . . . .                      | 211 |
| 2.36 PSP103VA MOSFET Device Instance Parameters. . . . .         | 212 |
| 2.37 PSP103VA MOSFET Device Model Parameters. . . . .            | 238 |
| 2.38 EKV3 MOSFET Device Instance Parameters. . . . .             | 239 |
| 2.39 EKV3 MOSFET Device Model Parameters. . . . .                | 247 |
| 2.40 Controlled Switch Model Parameters. . . . .                 | 256 |
| 2.41 Lossless (Ideal) Transmission Line Parameters. . . . .      | 258 |
| 2.42 Behavioral Digital Device Parameters. . . . .               | 261 |
| 2.43 Behavioral Digital Model Parameters. . . . .                | 262 |
| 2.44 PDE Device Instance Parameters. . . . .                     | 268 |
| 2.45 TCAD Device Model Parameters. . . . .                       | 268 |
| 2.46 PDE Device Doping Region Parameters . . . . .               | 269 |
| 2.47 Description of the flatx, flaty doping parameters . . . . . | 270 |
| 2.48 PDE Device Electrode Parameters. . . . .                    | 270 |
| 2.49 Intrinsic Carrier Concentration Parameters . . . . .        | 272 |
| 2.50 Bandgap constants . . . . .                                 | 273 |
| 2.51 Analytic Mobility Parameters . . . . .                      | 275 |
| 2.52 Arora Mobility Parameters . . . . .                         | 276 |
| 2.53 Carrier-Carrier Mobility Parameters . . . . .               | 278 |
| 2.54 Lombardi Surface Mobility Parameters . . . . .              | 280 |
| 2.55 Material workfunction values. . . . .                       | 287 |
| 2.56 Electron affinities . . . . .                               | 287 |
| <br>   |     |
| 3.1 List of <b>Xyce</b> command line arguments. . . . .          | 292 |
| <br>   |     |
| 6.1 Incompatibilities with PSpice. . . . .                       | 304 |
| <br>   |     |
| 7.1 Incompatibilities with ChileSPICE. . . . .                   | 307 |
| <br>   |     |
| 8.1 Issues for Microsoft Windows. . . . .                        | 309 |
| <br>   |     |
| 9.1 Xyce ascii rawfile format. . . . .                           | 312 |
| 9.2 Xyce binary rawfile format. . . . .                          | 312 |

# 1. Introduction

---

## Welcome to **Xyce**

The **Xyce** Parallel Electronic Simulator has been written to support, in a rigorous manner, the simulation needs of the Sandia National Laboratories electrical designers. It is targeted specifically to run on large-scale parallel computing platforms but also runs well on a variety of architectures including single processor workstations. It also aims to support a variety of devices and models specific to Sandia needs.

## 1.1 Overview

This document is intended to complement the **Xyce** Users' Guide [1]. It contains comprehensive, detailed information about a number of topics pertinent to the usage of **Xyce**. Included in this document is a netlist reference for the input-file commands and elements supported within **Xyce**; a command line reference, which describes the available command line arguments for **Xyce**; and quick-references for users of other circuit codes, such as Orcad's PSpice [2] and Sandia's ChileSPICE.

## 1.2 How to Use this Guide

This guide is designed so you can quickly find the information you need to use **Xyce**. It assumes that you are familiar with basic Unix-type commands, how Unix manages applications and files to perform routine tasks (e.g., starting applications, opening files and saving your work). Note that while Windows versions of **Xyce** are available, they are command-line programs meant to be run under the "Command Prompt," and are used almost identically to their Unix counterparts.

### Typographical conventions

Before continuing in this Reference Guide, it is important to understand the terms and typographical conventions used. Procedures for performing an operation are generally numbered with the following typographical conventions.

| Notation                 | Example  | Description  |
|--------------------------|--|--|
| Typewriter text          | xmpirun -np 4                                  | Commands entered from the keyboard on the command line or text entered in a netlist. |
| <b>Bold Roman Font</b>   | Set nominal temperature using the TNOM option. | SPICE-type parameters used in models, etc.   |
| Gray Shaded Text         | DEBUGLEVEL                                     | Feature that is designed primarily for use by Xyce developers.                       |
| [text in brackets]       | Xyce [options] <netlist>                       | Optional parameters.   |
| <text in angle brackets> | Xyce [options] <netlist>                       | Parameters to be inserted by the user.   |
| <object with asterisk>*  | K1 <ind. 1> [<ind. n>*]                        | Parameter that may be multiply specified.  |
| <TEXT1 TEXT2>            | .PRINT TRAN<br>+ DELIMITER=<TAB COMMA>         | Parameters that may only take specified values.                                      |

**Table 1.1.** Xyce typographical conventions.

## 1.3 Third Party License Information

Portions of the new DAE time integrator contained in the BackwardDifferentiation15 source and include files are derived from the IDA code from Lawrence Livermore National Laboratories and is licensed under the following license.

Copyright (c) 2002, The Regents of the University of California.  
Produced at the Lawrence Livermore National Laboratory.  
Written by Alan Hindmarsh, Allan Taylor, Radu Serban.  
UCRL-CODE-2002-59  
All rights reserved.

This file is part of IDA.

Redistribution and use in source and binary forms, with or without modification, are permitted provided that the following conditions are met:

1. Redistributions of source code must retain the above copyright notice, this list of conditions and the disclaimer below.
2. Redistributions in binary form must reproduce the above copyright notice, this list of conditions and the disclaimer (as noted below) in the documentation and/or other materials provided with the distribution.
3. Neither the name of the UC/LLNL nor the names of its contributors may be used to endorse or promote products derived from this software without specific prior written permission.

THIS SOFTWARE IS PROVIDED BY THE COPYRIGHT HOLDERS AND CONTRIBUTORS "AS IS" AND ANY EXPRESS OR IMPLIED WARRANTIES, INCLUDING, BUT NOT LIMITED TO, THE IMPLIED WARRANTIES OF MERCHANTABILITY AND FITNESS FOR A PARTICULAR PURPOSE ARE DISCLAIMED. IN NO EVENT SHALL THE REGENTS OF THE UNIVERSITY OF CALIFORNIA, THE U.S. DEPARTMENT OF ENERGY OR CONTRIBUTORS BE LIABLE FOR ANY DIRECT, INDIRECT, INCIDENTAL, SPECIAL, EXEMPLARY, OR CONSEQUENTIAL DAMAGES (INCLUDING, BUT NOT LIMITED TO, PROCUREMENT OF SUBSTITUTE GOODS OR SERVICES; LOSS OF USE,



DATA, OR PROFITS; OR BUSINESS INTERRUPTION) HOWEVER CAUSED AND ON ANY THEORY OF LIABILITY, WHETHER IN CONTRACT, STRICT LIABILITY, OR TORT (INCLUDING NEGLIGENCE OR OTHERWISE) ARISING IN ANY WAY OUT OF THE USE OF THIS SOFTWARE, EVEN IF ADVISED OF THE POSSIBILITY OF SUCH DAMAGE.

Additional BSD Notice  
-----

1. This notice is required to be provided under our contract with the U.S. Department of Energy (DOE). This work was produced at the University of California, Lawrence Livermore National Laboratory under Contract No. W-7405-ENG-48 with the DOE.
  
2. Neither the United States Government nor the University of California nor any of their employees, makes any warranty, express or implied, or assumes any liability or responsibility for the accuracy, completeness, or usefulness of any information, apparatus, product, or process disclosed, or represents that its use would not infringe privately-owned rights.
  
3. Also, reference herein to any specific commercial products, process, or services by trade name, trademark, manufacturer or otherwise does not necessarily constitute or imply its endorsement, recommendation, or favoring by the United States Government or the University of California. The views and opinions of authors expressed herein do not necessarily state or reflect those of the United States Government or the University of California, and shall not be used for advertising or product endorsement purposes.



# 2. Netlist Reference

---

## Chapter Overview

This chapter contains reference material directed towards working with circuit analyses in **Xyce** using the netlist interface. Included are detailed command descriptions, start-up option definitions and a list of devices supported by the **Xyce** netlist interface.

## 2.1 Netlist Commands

This section outlines the netlist commands that can be used with **Xyce** to setup and control circuit analysis.

### DC Sweep Analysis

Calculates the operating point for the circuit for a range of values. Primarily, this capability is applied to independent voltage sources, but it can also be applied to most device parameters. Note that this may be repeated for multiple sources in the same `.DC` line.

The `.DC` command can specify a linear sweep, decade logarithmic sweep, octave logarithmic sweep, or a list of values.

| Parameter   | Description      | Meaning   |
|-------------|------------------|---|
| <b>LIN</b>  | linear sweep     | The sweep variable is swept linearly from the starting to the ending value. |
| <b>OCT</b>  | sweep by octaves | Sweep by octaves. The sweep variable is swept logarithmically by octaves.   |
| <b>DEC</b>  | sweep by decades | Sweep by decades. The sweep variable is swept logarithmically by decades.   |
| <b>LIST</b> | list of values   | Use a list of values.   |

### Linear Sweeps

---

**General Form**      `.DC [LIN] <sweep variable name> <start> <stop> <step>`  
                          `+ [<sweep variable name> <start> <stop> <step>]...`

---

---

**Examples**

```
.DC LIN V1 5 25 5
.DC VIN -10 15 1
.DC R1 0 3.5 0.05 C1 0 3.5 0.5
```

---

## Decade Sweeps

---

**General Form**

```
.DC DEC <sweep variable name> <start> <stop> <points>
+ [DEC <sweep variable name><start> <stop> <points>]...
```

---

**Examples**

```
.DC DEC VIN 1 100 2
.DC DEC R1 100 10000 3 DEC VGS 0.001 1.0 2
```

---

## Octave Sweeps

---

**General Form**

```
.DC OCT <sweep variable name> <start> <stop> <points>
+ [OCT <sweep variable name><start> <stop> <points>]...
```

---

**Examples**

```
.DC OCT VIN 0.125 64 2
.DC OCT R1 0.015625 512 3 OCT C1 512 4096 1
```

---

## List Sweeps

---

**General Form**

```
.DC <sweep variable name> LIST <val> <val> <val> ...  
+ [<sweep variable name> LIST <val> <val> ...]...
```

---

**Examples**

```
.DC VIN LIST 1.0 2.0 5.0 6.0 10.0  
.DC VDS LIST 0 3.5 0.05 VGS LIST 0 3.5 0.5  
.DC TEMP LIST 10.0 15.0 18.0 27.0 33.0
```

---

## STEP Parametric Analysis

Calculates a full analysis (.DC or .TRAN) over a range of parameter values. This type of analysis is very similar to .DC analysis. Similar to .DC analysis, .STEP supports sweeps which are linear, decade logarithmic, octave logarithmic, or a list of values.

| Parameter   | Description      | Meaning   |
|-------------|------------------|---|
| <b>LIN</b>  | linear sweep     | The sweep variable is swept linearly from the starting to the ending value. |
| <b>OCT</b>  | sweep by octaves | Sweep by octaves. The sweep variable is swept logarithmically by octaves.   |
| <b>DEC</b>  | sweep by decades | Sweep by decades. The sweep variable is swept logarithmically by decades.   |
| <b>LIST</b> | list of values   | Use a list of values.   |

### Linear Sweeps

#### General Form

```
.STEP <parameter name> <initial> <final> <step>
```

#### Examples

```
.STEP TEMP -45 -55 -10
```

```
.STEP R1 45 50 5
```

```
.STEP C101:C 45 50 5
```

```
.STEP DLEAK:IS 1.0e-12 1.0e-11 1.0e-12
```

```
.STEP V1 20 10 -1
```

---

<initial>

Initial value for the parameter.

**Arguments  
and Options**

<final>

Final value for the parameter.

<step>

Value that the parameter is incremented at each step.

---

STEP parameter analysis will sweep a parameter from its initial value to its final value, at increments of the step size. At each step of this sweep, it will conduct a full analysis (.DC or .TRAN) of the circuit.

The specification is similar to that of a .DC sweep, except that each parameter gets its own .STEP line in the input file, rather than specifying all of them on a single line.

**Comments**

Output, as designated by a .PRINT statement, is slightly more complicated in the case of a .STEP simulation. If the user has specified a .PRINT line in the input file, Xyce will output two files. All steps of the sweep to a single output file as usual, but with the results of each step appearing one after another with the "Index" column starting over at zero. Additionally, a file with a ".res" suffix will be produced indicating what parameters were used for each iteration of the step loops.

This is a similar capability to that of PSPICE and ChileSPICE, but not identical. In future releases, this capability will be fully compatible.

---

## Decade Sweeps

---



**General Form**

```
.STEP DEC <sweep variable name> <start> <stop> <points>
```

---

**Examples**

```
.STEP DEC VIN 1 100 2  
.STEP DEC R1 100 10000 3  
.STEP DEC TEMP 1.0 10.0 3
```

---

## Octave Sweeps

---

**General Form**

```
.STEP OCT <sweep variable name> <start> <stop> <points>
```

---

**Examples**

```
.STEP OCT VIN 0.125 64 2  
.STEP OCT TEMP 0.125 16.0 2  
.STEP OCT R1 0.015625 512 3
```

---

## List Sweeps

---

**General Form**

```
.STEP <sweep variable name> LIST <val> <val> <val> ...  
+ [<sweep variable name> LIST <val> <val> ...]...
```

---

---

**Examples**

.STEP VIN LIST 1.0 2.0 10. 12.0

.STEP TEMP LIST 8.0 21.0

---

## Transient Analysis

Calculates the time-domain response of a circuit for a specified duration.

---

### **General Form**

```
.TRAN <print step value> <final time value>  
+ [<start time value> [<step ceiling value>]] [NOOP] [UIC]  
+ [{schedule( <time>, <maximum time step>, ... )}]
```

---

### **Examples**

```
.TRAN 1us 100ms  
  
.TRAN 1ms 100ms 0ms .1ms  
.TRAN 0 2.0e-3 schedule( 0.5e-3, 0, 1.0e-3, 1.0e-6, 2.0e-3, 0 )
```

---

---

<print step value>

Used to calculate the initial time step (see below).

<final time value>

Sets the end time (duration) for the analysis.

[<start time value>]

Sets the time at which output of the simulation results is to begin. Defaults to zero.

**Arguments**  
**and Options**

[<step ceiling value>]

Sets a maximum time step. Defaults to ((final time value)-(start time value))/10, unless there are breakpoints (see below).

[NOOP]

Specifies that no operating point calculation is to be performed.

[UIC]

Specifies that no operating point calculation is to be performed, and that the specified initial condition (from .IC lines) should be used in its place.

```
[{schedule( <time>, <maximum time step>, ... )}]
```

**Arguments  
and Options**

Specifies a schedule for maximum allowed time steps. The list of arguments,  $t_0$ ,  $\Delta t_0$ ,  $t_1$ ,  $\Delta t_1$ , *etc.* implies that a maximum time step of  $\Delta t_0$  will be used while the simulation time is greater than or equal to  $t_0$  and less than  $t_1$ . A maximum time step of  $\Delta t_1$  will be used when the simulation time is greater or equal to than  $t_1$  and less than  $t_2$ . This sequence will continue for all pairs of  $t_i$ ,  $\Delta t_i$  that are given in the {schedule()}. If  $\Delta t$  is zero or negative, then no maximum time step is enforced (other than hardware limits of the host computer).

---

The transient analysis calculates the circuit's response over an interval of time beginning with TIME=0 and finishing at <final time value>. Use a .PRINT (print) statement to get the results of the transient analysis.

Before calculating the transient response **Xyce** computes a bias point for the circuit that is different from the regular bias point. This is necessary because at the start of a transient analysis, the independent sources can have different values than their DC values. Specifying NOOP on the .TRAN line causes **Xyce** to begin the transient analysis without performing the usual bias point calculation.

**Comments**

The time integration algorithms within **Xyce** use adaptive time-stepping methods that adjust the time-step size according to the activity in the analysis. The default ceiling for the internal time step is ( $\langle \text{final time value} \rangle - \langle \text{start time value} \rangle$ )/10. This default ceiling value is automatically adjusted if breakpoints are present, to insure that there are always at least 10 time steps between breakpoints. If the user specifies a ceiling value, however, it overrides any internally generated ceiling values.

**Xyce** is not strictly compatible with SPICE in its use of the values on the .TRAN line. In **Xyce**, <print step value> is not used as the printing interval. It is used in determining the initial step size, which is chosen to be the smallest of three quantities: the print step value, the step ceiling value, and 1/200th of the time until the next breakpoint.

The third argument to .TRAN simply determines the earliest time for which results are to be output. Simulation of the circuit always begins at TIME=0 irrespective of the setting of <start time value>.

---

## Harmonic Balance Analysis

Calculates steady states of nonlinear circuits in the frequency domain.

---

**General Form**      `.HB <fundamental frequency>`

---

**Examples**            `.HB 1e4`

---

**Arguments**            `<fundamental frequency>`

**and Options**

     Sets the fundamental frequency for the analysis.

---

**Comments**            Harmonic balance analysis calculates the magnitude and phase of voltages and currents in a nonlinear circuit. Use a `.PRINT` (print) statement to get the results of the harmonic balance analysis.

---

## Multi-Time Partial Differential Equation (MPDE) Analysis

Calculates the time-domain response of a circuit with two disparate time scales.

---

**General Form**      .MPDE <print step value> <final time value>

---

**Examples**            .MPDE 1us 100ms

---

<print step value>

**Arguments and Options**      Used to calculate the initial time step (see .tran).  
<final time value>

     Sets the end time (duration) for the analysis.

---

**Comments**

---

## Device Modeling

### .MODEL (Model Definition)

Modeled device definition.

### .SUBCKT (subcircuit)

The .SUBCKT statement begins a subcircuit definition by giving its name, the number and order of its nodes and the names and default parameters that direct its behavior. The .ENDS statement signifies the end of the subcircuit definition.

---

#### **General Form**

```
.SUBCKT <name> [node]*
+ [PARAMS: < <name> = <value> >* ]
...
.ENDS
```

---

#### **Examples**

```
.SUBCKT OPAMP 10 12 111 112 13
...
.ENDS

.SUBCKT FILTER1 INPUT OUTPUT PARAMS: CENTER=200kHz,
+ BANDWIDTH=20kHz
...
.ENDS

.SUBCKT PLRD IN1 IN2 IN3 OUT1
+ PARAMS: MNTYMXDELY=0 IO_LEVEL=1
...
.ENDS

.SUBCKT 74LS01 A B Y
+ PARAMS: MNTYMXDELY=0 IO_LEVEL=1
...
.ENDS
```

---



---

<name>

The name used to reference a subcircuit.

[node]\*

An optional list of nodes. This is not mandatory since it is feasible to define a subcircuit without any interface nodes.

**Arguments**  
**and Options**

[PARAMS:]

Keyword that provides values to subcircuits as arguments for use as expressions in the subcircuit. Parameters defined in the PARAMS: section may be used in expressions within the body of the subcircuit and will take the default values specified in the subcircuit definition unless overridden by a PARAMS: section when the subcircuit is instantiated.

---

---

A subcircuit designation ends with a `.ENDS` command. The entire netlist between `.SUBCKT` and `.ENDS` is part of the definition. Each time the subcircuit is called via an `X` device, the entire netlist in the subcircuit definition replaces the `X` device.

There must be an equal number of nodes in the subcircuit call and in its definition. As soon as the subcircuit is called, the actual nodes (those in the calling statement) substitute for the argument nodes (those in the defining statement).

Node zero cannot be used in this node list, as it is the global ground node.

Subcircuit references may be nested to any level. Subcircuits definitions may also be nested; a `.SUBCKT` statement and its closing `.ENDS` may appear between another `.SUBCKT/.ENDS` pair. A subcircuit defined inside another subcircuit definition is local to the outer subcircuit and may not be used at higher levels of the circuit netlist.

Subcircuits should include only device instantiations and possibly these statements:

#### Comments

- `.MODEL` (model definition)
- `.PARAM` (parameter)
- `.FUNC` (function)

Models, parameters, and functions defined within a subcircuit are scoped to that definition. That is they are only accessible within the subcircuit definition in which they are included. Further, if a `.MODEL`, `.PARAM` or a `.FUNC` statement is included in the main circuit netlist, it is accessible from the main circuit as well as all subcircuits.

Node, device, and model names are scoped to the subcircuit in which they are defined. It is allowable to use a name in a subcircuit that has been previously used in the main circuit netlist. When the subcircuit is flattened (expanded into the main netlist), all of its names are given a prefix via the subcircuit instance name. For example, `Q17` becomes `X3:Q17` after expansion. After expansion, all names are unique. The single exception occurs in the use of global node names, which are not expanded.

---

**.ENDS (end subcircuit)**

Marks the end of a subcircuit definition.

## Output Control

### .MEASURE (measure)

The .MEASURE statement allows calculation or reporting of simulation metrics to an external file. One can measure when simulated signals reach designated values or equal other simulation values. The syntax for a .MEASURE statement is as follows:

---

**General Form**    .MEASURE <analysis type> resultName WHEN outVar = <outVar2|value>  
                  + [TD=value] [RISE=r|LAST] [FALL=f|LAST] [CROSS=c|LAST]  
                  + [GOAL=value] [MINVAL=value] [WEIGHT=value]

---

```
VS 1 0 SIN(0 1.0 1KHZ 0 0)
R1 1 0 100
```

### Examples

```
.measure tran hit1_75 when v(1)=0.75 minval=0.02
.measure tran hit2_75 when v(1)=0.75 minval=0.08 rise=2

.PRINT TRAN V(1) V(2)
.TRAN 0 10ms 1ms
.END
```

---

---

<analysis type>

Currently, only one analysis type, TRAN, is supported.

resultName

Measured results are reported to the output and log file. Additionally results are stored in a file called `circuitFileName.mt#` where the suffixed number starts at 0 and increases for multiple iterations of a given simulation. Each line of this file will contain the measurement name, `resultName` followed by its value for that run.

outVar = <outVar2|value>

This represents the test for the stated measurement. `outVar` is a simulation quantity such as a voltage or current. One can compare it to another simulation variable or a fixed quantity.

TD=value

A time delay before which this measurement should be taken or checked.

### Arguments and Options

RISE=r|LAST

The number of rises after which the measurement should be checked. If `LAST` is specified, then the last rise found in the simulation will be used.

FALL=f|LAST

The number of falls after which the measurement should be checked. If `LAST` is specified, then the last fall found in the simulation will be used.

CROSS=c|LAST

The number of zero crossings after which the measurement should be checked. If `LAST` is specified, then the last zero crossing found in the simulation will be used.

MINVALUE=value

An allowed absolute difference between `outVal` and the variable to which it is being compared. This has a default value of `1.0e-12`. One may need to specify a larger value to avoid missing the test condition in a transient run.

GOAL=value

**Arguments**

This parameter is reserved for optimization and will be used in future versions of **Xyce**

**and Options**

*continued*

WEIGHT=value

This parameter is reserved for optimization and will be used in future versions of **Xyce**

**.PRINT (print)**

Send analysis results to an output file. **Xyce** supports several options on the .PRINT line of netlists:

**General Form**

```
.PRINT <analysis type> [FORMAT=<STD|NOINDEX|PROBE|TECPLOT|RAW|CSV>]
+ [FILE=<output filename>] [WIDTH=<print field width>]
+ [PRECISION=<floating point output precision>]
+ [FILTER=<absolute value below which a number outputs as 0.0>]
+ [DELIMITER=<TAB|COMMA>] [TIMESCALEFACTOR=<real scale factor>]
+ <output variable>
```

```
.print tran format=tecplot V(1) I(Vsrc) {V(1)*(I(Vsrc)**2.0)}  
.PRINT TRAN FORMAT=PROBE FILE=foobar.csd V(1) {abs(V(1))-5.0}  
.PRINT DC FILE=foobar.txt WIDTH=19 PRECISION=15 FILTER=1.0e-10  
+ I(VSOURCE5) I(VSOURCE6)
```

**Examples**

```
.print tran FORMAT=RAW V(1) I(Vsrc)  
  
R1 1 0 100  
X1 1 2 3 MySubcircuit  
V1 3 0 1V  
.SUBCKT MYSUBCIRCUIT 1 2 3  
R1 1 2 100K  
R2 2 4 50K  
R3 4 3 1K  
.ENDS  
.PRINT DC V(X1:4) V(2) I(V1)
```

---

---

<analysis type>

Only one analysis type (DC or TRAN) may be given for each .PRINT netlist entry.

[FORMAT=<STD | NOINDEX | PROBE | TECPLOT | RAW | CSV>]

The output format may be specified using the FORMAT option. The STD format outputs the data divided up into data columns. The NOINDEX format is the same as the STD format except that the index column is omitted. The PROBE format specifies that the output should be formatted to be compatible with the PSpice Probe plotting utility. The TECPLOT format specifies that the output should be formatted to be compatible with the Tecplot plotting program. The RAW format specifies that the output should comply with the Spice binary rawfile format. Use with the **-a** command line option to output an ascii rawfile. The CSV format specifies that the output file should be a comma-separated value file with a header indicating the variables printed in the file. It is similar to, but not identical to using DELIMITER=COMMA; the latter will also print a footer that is not compatible with most software that requires CSV format.

### **Arguments and Options**

[FILE=<output filename>]

Specifies the name of the file to which the output will be written.

[WIDTH=<print field width>]

Controls the output width used in formatting the output.

[PRECISION=<floating point precision >]

Number of floating point digits past the decimal for output data.

[FILTER=<filter floor value>]

Used to specify the absolute value below which output variables will be printed as 0.0.

[DELIMITER=<TAB | COMMA>]

Used to specify an alternate delimiter in the STD or NOINDEX format output.

TIMESCALEFACTOR=<real scale factor>

Specify a constant scaling factor for time. Time is normally printed in units of seconds, but if one would like the units to be milliseconds, then set TIMESCALEFACTOR=1000.

---



---

<output variable>

Following the analysis type and other options is a list of output variables. There is no upper bound on the number of output variables. The output is divided up into data columns and output according to any specified options (see options given above). Output variables can be specified in four ways:

**Arguments**  
**and Options**  
*continued*

- V(<circuit node>) to output the voltage at a point in the circuit
- I(<device>) to output current through a two terminal device.
- I<lead abbreviation>(<device>) to output current into a particular lead of a three or more terminal device.
- {expression} to output an expression involving V and I values.

Further explanation of current specification is in comments section below.

---

---

**Comments**

Currents are positive flowing from node 1 to node 2 for two node devices, and currents are positive flowing into a particular lead for leads. <circuit node> is simply the name of any node in your top-level circuit, or <subcircuit name>:<node> to reference nodes that are internal to a subcircuit. <device> is the name of any device in your top-level circuit, or <subcircuit name>:<device> to reference devices that are internal to a subcircuit. <lead abbreviation> is a single character designator for individual leads on a device with three or more leads. For bipolar transistors these are: c (collector), b (base), e (emitter), s (substrate). For mosfets, lead abbreviations are: d (drain), g (gate), s (source), and b (bulk). SOI transistors have: d, g, s, e (bulk), and b (body). For PDE devices, the nodes are numbered according to the order they appear, so lead currents are referenced like i1(<device>), i2(<device>), etc.

The values of the output variables are output as a series of columns (one for each output variable). Note that while the .PRINT line supports expressions, .PRINT line expressions do not recognize .PARAM specified parameters. For example, this .PRINT line:

```
.PARAM tmpval=0.33
R1 0 1 tmpval
.PRINT TRAN V(1) {tmpval*V(1)}
```

will fail with an error saying that tmpval is not recognized in the .PRINT expression.

---

## Netlist Processing

### .END (End of Circuit)

End of netlist file.

### .FUNC (function)

User defined functions that can be used in expressions appearing later in the same scope as the .FUNC statement.

---

#### **General Form**

.FUNC <name>([arg]\*) <body>

---

#### **Examples**

```
.FUNC E(x) {exp(x)}
.FUNC DECAY(CNST) {E(-CNST*TIME)}
.FUNC TRIWAV(x) {ACOS(COS(x))/3.14159}
.FUNC MIN3(A,B,C) {MIN(A,MIN(B,C))}
```

---

.FUNC

Must precede the first use of the function name. Functions cannot be redefined and the function name must not be the same as any of the predefined functions (e.g., SIN and SQRT). .FUNC arguments cannot be node names.

#### **Arguments and Options**

<body>

May refer to other (previously defined) functions; the second example, DECAY, uses the first example, E.

[arg]

The number of arguments in the use of a function must agree with the number in the definition. Parameters, TIME, and other functions are allowed in the body of function definitions.

---

#### **Comments**

The <body> of a defined function is handled in the same way as any math expression; it must be enclosed in curly braces .

---

### .INC or .INCLUDE (include file)

Include specified file in netlist.

The file name can be surrounded by double quotes, "filename", but this is not necessary. The directory for the include file is assumed to be the execution directory unless a full or relative path is given as a part of the file name.

### .LIB (library file) (section name)

Include all blocks denoted by the section name of the specified library file.

The library file name can be surrounded by double quotes, as in "path/filename" but this is not necessary. The directory for the library file is assumed to be the execution directory unless a full or relative path is given as a part of the file name. The section name denotes the section or sections of the library file to include. For example if the section name is `nominal` then all netlist commands between the statements

```
.LIB nominal
```

```
.ENDL
```

would be parsed for a given simulation. Any lines not surrounded by a `.LIB section-name, .ENDL` in a library file will always be parsed for a given simulation.

### .PARAM (parameter)

User defined parameter that can be used in expressions throughout the netlist.

---

#### **General Form**

```
.PARAM [<name>=<value>]*
```

---

#### **Examples**

```
.PARAM A_Param=1K  
.PARAM B_Param={A_Param*3.1415926535}
```

---

---

|                        |   |
|------------------------|---|
| <b><u>Comments</u></b> | Parameters defined using <code>.PARAM</code> are evaluated when the netlist is read in, and therefore must evaluate to constants at the time the netlist is parsed. It is therefore illegal to use any time- or solution-dependent terms in parameter definitions, including the <code>TIME</code> variable or any nodal voltages. Since they must be constants, these parameters may also not be used in <code>.STEP</code> loops. |
|------------------------|---|

---

### `.GLOBAL_PARAM` (global parameter)

User defined global parameter that can be time dependent, or that can be used in `.STEP` loops.

---

|                            |  |
|----------------------------|--|
| <b><u>General Form</u></b> | <code>.GLOBAL_PARAM [&lt;name&gt;=&lt;value&gt;]*</code> |
|----------------------------|--|

---

|                        |  |
|------------------------|--|
| <b><u>Examples</u></b> | <code>.GLOBAL_PARAM T={27+100*time}</code> |
|------------------------|--|

---

|                        |  |
|------------------------|--|
| <b><u>Comments</u></b> | <p>You may use parameters defined by <code>.PARAM</code> in expressions used to define global parameters, but you may <i>not</i> use global parameters in <code>.PARAM</code> definitions.</p> <p>Unlike <code>.PARAM</code> parameters, global parameters are evaluated at the time they are needed and may therefore be time dependent and may depend on other time dependent quantities in the circuit.</p> <p>Global parameters are accessible and have the same value throughout all levels of the netlist hierarchy. It is not legal to redefine global parameters in different levels of the netlist hierarchy.</p> |
|------------------------|--|

---

## Miscellaneous Commands

### \* (Comment)

Create a netlist comment line.

### ; (In-line Comment)

Add a netlist in-line comment

## + (Line Continuation)

Continue the text of the previous line

## .OPTIONS Statements

### .OPTIONS (Analysis Options)

Set various simulation limits, analysis control parameters and output characters. In general, they use the following format:

```
.OPTIONS <PKG> [<TAG>=<VALUE>]*
```

Exceptions to this format include the `OUTPUT` and `RESTART` options that use their own format, which will be defined under their respective descriptions.

The designator `PKG` refers to the Unified Modeling Language (UML) *package* which refers loosely to a *module* in the code. Thus, the term is used here as identifying a specific *module* to be controlled via *options* set in the netlist input file. The packages which currently support `.OPTIONS`, and the keywords to use in place of `<PKG>` are:

| Package                            | PKG keyword |
|------------------------------------|-------------|
| Global:                            | GLOBAL      |
| Device Model:                      | DEVICE      |
| Time Integration:                  | TIMEINT     |
| Nonlinear Solver:                  | NONLIN      |
| Transient Nonlinear Solver:        | NONLIN-TRAN |
| Continuation/Bifurcation Tracking: | LOCA        |
| Linear Solver:                     | LINSOL      |
| Output:                            | OUTPUT      |
| Restart:                           | RESTART     |
| MPDE:                              | MPDEINT     |
| Harmonic Balance:                  | HBINT       |

As an example, the following netlist line will set the value of **ABSTOL** in the time integration package to  $1 \times 10^{-8}$ :

**Example:**            .OPTIONS TIMEINT ABSTOL=1E-8

Below is an outline of the supported packages and their respective options:

### Device Package Options

The device package parameters listed in Table 2.1 outline the options available for specifying device specific parameters. Some of these (**DEFAS**, **DEFAD**, **TNOM** etc.) have the same meaning as they do for the **.OPTION** line from Berkeley SPICE (3f5). Parameters which apply globally to all device models will be specified here. Parameters specific to a particular device instance or model are specified in section 2.2.

| Device Model (PKG = DEVICE) Tag | Description   | Default           |
|---------------------------------|---|-------------------|
| DEFAS                           | MOS Drain Diffusion Area  | 0.0               |
| DEFAD                           | MOS Source Diffusion Area   | 0.0               |
| DEFL                            | MOS Default Channel Length  | 1.0E-4            |
| DEFW                            | MOS Default Channel Width   | 1.0E-4            |
| GMIN                            | Minimum Conductance   | 1.0E-12           |
| MINRES                          | Lead resistance for semiconductor device leads specified as zero            | 0.0               |
| MINCAP                          | Capacitance to use for semiconductor junction capacitance specified as zero | 0.0               |
| TEMP                            | Temperature   | 27.0 °C (300.15K) |
| TNOM                            | Nominal Temperature   | 27.0 °C (300.15K) |
| NUMJAC                          | Numerical Jacobian flag (only use for small problems)                       | 0 (FALSE)         |
| VOLTLIM                         | Voltage limiting  | 1 (TRUE)          |

| Device Model (PKG = DEVICE) Tag         | Description   | Default   |
|---|---|-----------|
| icFac                                   | This is a multiplicative factor which is applied to right-hand side vector loads of .IC initial conditions during the DCOP phase.   | 10000.0   |
| LAMBERTW                                | This flag determines if the Lambert-W function should be applied in place of exponentials in hard-to-solve devices. Currently, this capability is implemented in the diode and BJT. Try this for BJT circuits that have convergence problems. For best effect, this option should be tried with voltlim turned off. A detailed explanation of the Lambert-W function, and its application to device modeling can be found in reference [3]. | 0 (FALSE) |
| MAXTimestep                             | Maximum time step size  | 1.0E+99   |
| <b><i>MOSFET Homtopy parameters</i></b> |   |           |
| VDSSCALEMIN                             | Scaling factor for Vds  | 0.3       |
| VGSTCONST                               | Initial value for Vgst  | 4.5 Volt  |
| LENGTH0                                 | Initial value for length  | 5.0e-6    |
| WIDTH0                                  | Initial value for width   | 200.0e-6  |
| TOX0                                    | Initial value for oxide thickness   | 6.0e-8    |
| <b><i>Debug output parameters</i></b>   |   |           |
| DEBUGLEVEL                              | The higher this number, the more info is output   | 1         |
| DEBUGMINTimestep                        | First time-step debug information is output   | 0         |



| Device Model (PKG = DEVICE) Tag | Description  | Default |
|---------------------------------|--|---------|
| DEBUGMAXTIMESTEP                | Last time-step of debug output   | 65536   |
| DEBUGMINTIME                    | Same as DEBUGMINTIMESTEP except controlled by time (sec.) instead of step number | 0.0     |
| DEBUGMAXTIME                    | Same as DEBUGMAXTIMESTEP except controlled by time (sec.) instead of step number | 100.0   |

Table 2.1: Options for Device Package

### Time Integration Options

The time integration parameters listed in Table 2.2 give the available options for helping control the time integration algorithms for transient analysis.

| Time Integration (PKG = TIMEINT) Tag | Description  | Default     |
|--------------------------------------|--|-------------|
| METHOD                               | Time integration method. This parameter is only relevant when running <b>Xyce</b> in transient mode. Supported methods: <ul style="list-style-type: none"> <li>■ 6 (Backward Difference Formula orders 1-5)</li> <li>■ 7 (variable order Trapezoid)</li> </ul> | 6 (BDF 1-5) |
| RELTOL                               | Relative error tolerance   | 1.0E-02     |
| ABSTOL                               | Absolute error tolerance   | 1.0E-06     |

| Time Integration (PKG = TIMEINT) Tag | Description  | Default  |
|--------------------------------------|--|----------|
| RESTARTSTEPSCALE                     | This parameter is a scalar which determines how small the initial time step out of a breakpoint should be. In the current version of the time integrator, the first step after a breakpoint isn't subjected to much error analysis, so for very stiff circuits, this step can be problematic.  | 0.005    |
| NLNEARCONV                           | This flag sets if "soft" failures of the nonlinear solver, when the convergence criteria are almost, but not quite, met, should result in a "success" code being returned from the nonlinear solver to the time integrator. If this is enabled, it is expected that the error analysis performed by the time integrator will be the sole determination of whether or not the time step is considered a "pass" or a "fail". This is on by default, but occasionally circuits need tighter convergence criteria. | 1 (TRUE) |
| NLSMALLUPDATE                        | This is another "soft" nonlinear solver failure flag. In this case, if the flag is set, time steps in which the nonlinear solver stalls, and is using updates that are numerically tiny, can be considered to have converged by the nonlinear solver. If this flag is set, the time integrator is responsible for determining if a step should be accepted or not.   | 1 (TRUE) |
| RESETTRANLS                          | The nonlinear solver resets its settings for the transient part of the run to something more efficient (basically a simpler set of options with smaller numbers for things like max Newton step). If this is set to false, this resetting is turned off. Normally should be left as default.   | 1 (TRUE) |

| Time Integration (PKG = TIMEINT) Tag | Description   | Default |
|--------------------------------------|---|---------|
| MAXORD                               | This parameter determines the maximum order of integration that the BDF 1-5 integrator will attempt. This can be reduced down to 1 to use Backward Euler and can be set at 2 when BDF 1-2 is desired. Setting this option does not guarantee that the integrator will integrate at this order, it just sets the maximum order the integrator will attempt. In order to guarantee a particular order is used, see the option MINORD below.                                 | 5       |
| MINORD                               | This parameter determines the minimum order of integration that the BDF 1-5 integrator will attempt to maintain. The integrator will start at Backward Euler and move up in order as quickly as possible to achieve MINORD and then it will keep the order above this. If MINORD is set at 2 and MAXORD is set at 2, then the integrator will move to second order as quickly as possible and stay there. This mode closely approximates a fixed second-order BDF method. | 1       |

| Time Integration (PKG = TIMEINT) Tag | Description   | Default                            |
|--------------------------------------|---|------------------------------------|
| ERROPTION                            | <p>This parameter determines if Local Truncation Error (LTE) control is turned on or not. If ERROPTION is on, then step-size selection is based on the number of Newton iterations nonlinear solve. For BDF15, if the nonlinear solve succeeds, then the step is doubled, otherwise it is cut by one eighth. For Trapezoid, if the number of nonlinear iterations is below NLMIN then the step is doubled. If the number of nonlinear iterations is above NLMAX then the step is cut by one eighth. In between, the step-size is left alone. Because this option can lead to very large time-steps, it is very important to specify an appropriate DELMAX option. If the circuit has breakpoints, then the option MINTIMESTEPSBP can also help to adjust the maximum time-step by specifying the minimum number of time points between breakpoints.</p> | 0 (Local Truncation Error is used) |
| NLMIN                                | <p>This parameter determines the lower bound for the desired number of nonlinear iterations during a Trapezoid time integration solve with ERROPTION=1.</p>   | 3                                  |
| NLMAX                                | <p>This parameter determines the upper bound for the desired number of nonlinear iterations during a Trapezoid time integration solve with ERROPTION=1.</p>   | 8                                  |
| DELMAX                               | <p>This parameter determines the maximum time step-size used with ERROPTION=1. If a maximum time-step is also specified on the .TRAN line, then the minimum of that value and DELMAX is used.</p>   | 1e99                               |
| MINTIMESTEPSBP                       | <p>This parameter determines the minimum number of time-steps to use between breakpoints. This enforces a maximum time-step between breakpoints equal to the distance between the last breakpoint and the next breakpoint divided by MINTIMESTEPSBP.</p>  | 10                                 |

| Time Integration (PKG = TIMEINT) Tag | Description   | Default  |
|--------------------------------------|---|--|
| TIMESTEPSREVERSAL                    | <p>This parameter determines whether time-steps are rejected based upon the step-size selection strategy in ERROPTION=1. If it is set to 0, then a step will be accepted with successful nonlinear solves independent of whether the number of nonlinear iterations is between NLMIN and NLMAX. If it is set to 1, then when the number of nonlinear iterations is above NLMAX, the step will be rejected and the step-size cut by one eighth and retried. If ERROPTION=0 (use LTE) then TIMESTEPSREVERSAL=1 (reject steps) is set. This has the consequence that for the BDF15 integrator, TIMESTEPREVERSAL=1.</p>                 | <p>0 (do not reject steps)</p>   |
| DOUBLED COPSTEP                      | <p>This option should only be set to TRUE for a PDE device run. PDE devices often have to solve an extra "setup" problem to get the initial condition. This extra setup problem solves a nonlinear Poisson equation (see the device appendix for more details), while the normal step solves a full drift-diffusion(DD) problem. The name of this flag refers to the fact that the code is essentially taking two DC operating point steps instead of one. If you set this to TRUE, but have no PDE devices in the circuit, the code will repeat the same identical DCOP step twice. Generally there is no point in doing this.</p> | <ul style="list-style-type: none"> <li>• 0 (FALSE), if no PDE devices are present.</li> <li>• 1 (TRUE), if at least one PDE device is in the circuit.</li> </ul> |

| Time Integration (PKG = TIMEINT) Tag | Description   | Default  |
|--------------------------------------|---|----------|
| FIRSTDCOPSTEP                        | <p>This is the index of the first DCOP step taken in a simulation for which DOUBLED COPSTEP is set to TRUE. The special initialization (nonlinear Poisson) step is referred to as step 0, while the normal (drift-diffusion) step is indexed with a 1. These two options (FIRSTDCOPSTEP and LASTDCOPSTEP) allow you to set the 1st or second DCOP step to be either kind of step. If FIRSTDCOPSTEP and LASTDCOPSTEP are both set to 0, then only the initial setup step happens. If FIRSTDCOPSTEP and LASTDCOPSTEP are both set to 1, then the initialization step doesn't happen, and only the real DD problem is attempted, with a crude initial guess. You should <i>never</i> set FIRSTDCOPSTEP to 1 and SECONDDCOPSTEP to 0. Normally, they should always be left as the defaults.</p> | 0        |
| LASTDCOPSTEP                         | <p>This is the second step taken in a simulation for which DOUBLED COPSTEP is set to TRUE.</p>  | 1        |
| BPENABLE                             | <p>Flag for turning on/off breakpoints (1 = ON, 0 = OFF). It is unlikely anyone would ever set this to FALSE, except to help debug the breakpoint capability.</p>   | 1 (TRUE) |

| Time Integration (PKG = TIMEINT) Tag | Description  | Default |
|--------------------------------------|--|---------|
| EXITTIME                             | If this is set to nonzero, the code will check the simulation time at the end of each step. If the total time exceeds the exittime, the code will ungracefully exit. This is a debugging option, the point of which is to have the code stop at a certain time during a run without affecting the step size control. If not set by the user, it isn't activated. | -       |
| EXITSTEP                             | Same as EXITTIME, only applied to step number. The code will exit at the specified step. If not set by the user, it isn't activated.   | -       |

Table 2.2: Options for Time Integration Package.

### Multi-Time Partial Differential Equation Options (MPDE)

**Xyce** has the ability to quickly simulate systems with two separated time scales, *i.e.* a *fast* and *slow* time scale. In this case, **Xyce** computes a set of solutions on the *fast* time scale and then tries to integrate this set of solutions forward in time along the *slow* time scale. Please see the **Xyce** Users' Guide for more information.

| Multi-Time Partial Differential Equation Analysis (PKG = MPDEINT) Tag | Description                                   | Default |
|---|---|---------|
| N2  | Number of time points in the fast time domain | 20      |

| Multi-Time Partial Differential Equation Analysis (PKG = MPDEINT) Tag | Description  | Default |
|---|--|---------|
| AUTON2  | Do a one period initial transient run to determine the number and location of the fast time points.          | false   |
| AUTON2MAX   | The maximum number of fast time points to keep from an initial transient run.                                | 20      |
| OSCSRC  | A list of voltage or current sources which change on the fast time scale.                                    | VIN     |
| STARTUPPERIODS  | The number of fast time periods to integrate through before calculating the MPDE initial conditions.         | 0       |
| OSCOUT  | Node for periodicity condition for Warped MPDE   |         |
| PHASE   | Phase specification for Warped MPDE  | 0       |
| PHASECOEFF  | Phase coefficient for Warped MPDE  |         |
| T2  | The time in seconds of the fast time period. This overrides any automatically determined period from OSCSRC. | 0       |
| WAMPDE  | Flag specifying that this will be Warped MPDE calculation  | false   |
| FREQDOMAIN  |  |         |
| ICPER   |  |         |
| IC  | Initial condition calculation method to use. Use 0 for Sawtooth or 1 for a transient run.                    | 0       |



| <b>Multi-Time Partial Differential Equation Analysis (PKG = MPDEINT) Tag</b> | <b>Description</b>  | <b>Default</b> |
|--|---|----------------|
| DIFF   | Differentiation scheme to use on the fast time scale. Use 0 for backwards difference and 1 for central differences. | 0              |
| DIFFORDER  | Differentiation order for fast time scale time derivatives.   | 1              |

Table 2.3: Options for MPDE Package.

### Harmonic Balance Options

The Harmonic Balance parameters listed in Table 2.4 give the available options for helping control the harmonic balance algorithms for harmonic balance analysis.

| <b>Harmonic balance Analysis (PKG = hbint) Tag</b> | <b>Description</b>  | <b>Default</b> |
|--|---|----------------|
| numfreq  | Number of harmonic frequencies to be calculated and it must be an odd number.                   | 21             |
| STARTUPPERIODS                                     | The number of fast time periods to integrate through before calculating the initial conditions. | 0              |

Table 2.4: Options for HB.

### Nonlinear Solver Options

The nonlinear solver parameters listed in Table 2.5 provide methods for controlling the nonlinear solver for DC, Transient and harmonic balance. Note that the nonlinear solver options for DCOP, transient and harmonic balance are specified in separate options statements, using .OPTIONS NONLIN, .OPTIONS NONLIN-TRAN and .OPTIONS NONLIN-HB, re-

spectively. The defaults for each are specified in the third and fourth columns of Table 2.5.

| Nonlinear Solver<br>(PKG = NONLIN)<br>and (PKG =<br>NONLIN-TRAN)<br>Tags | Description   | NONLIN<br>Default   | NONLIN-TRAN<br>Default |
|--|---|---|------------------------|
| NOX  | Use NOX nonlinear solver.   | 1 (TRUE)  | 1 (TRUE)               |
| NLSTRATEGY   | Nonlinear solution strategy.<br>Supported Strategies: <ul style="list-style-type: none"> <li>■ 0 (Newton)</li> <li>■ 1 (Gradient)</li> <li>■ 2 (Trust Region)</li> </ul>  | 0 (Newton)  | 0 (Newton)             |
| SEARCHMETHOD   | Line-search method used by the<br>nonlinear solver. Supported<br>line-search methods: <ul style="list-style-type: none"> <li>■ 0 (Full Newton - no line search)</li> <li>■ 1 (Interval Halving)</li> <li>■ 2 (Quadratic Interpolation)</li> <li>■ 3 (Cubic Interpolation)</li> <li>■ 4 (More'-Thuente)</li> </ul> | 0 (Full Newton)<br>(NOTE: for iterative linear solves, the default is Quadratic Linesearch - 2) | 0 (Full Newton)        |

| Nonlinear Solver<br>(PKG = NONLIN)<br>and (PKG =<br>NONLIN-TRAN)<br>Tags | Description   | NONLIN<br>Default            | NONLIN-TRAN<br>Default       |
|--|---|------------------------------|------------------------------|
| CONTINUATION   | <p>Enables the use of Homotopy/Continuation algorithms for the nonlinear solve. Options are:</p> <ul style="list-style-type: none"> <li>■ 0 (Standard nonlinear solve)</li> <li>■ 1 (Natural parameter homotopy. See LOCA options list)</li> <li>■ 2 (Specialized dual parameter homotopy for MOSFET circuits)</li> </ul> | 0 (Standard nonlinear solve) | 0 (Standard nonlinear solve) |
| ABSTOL   | Absolute residual vector tolerance  | 1.0E-12                      | 1.0E-06                      |
| RELTOL   | Relative residual vector tolerance  | 1.0E-03                      | 1.0E-02                      |
| DELTAXTOL  | Weighted nonlinear-solution update norm convergence tolerance   | 1.0                          | 0.33                         |
| RHSTOL   | Residual convergence tolerance (unweighted 2-norm)  | 1.0E-06                      | 1.0E-02                      |
| SMALLUPDATETOL   | Minimum acceptable norm for weighted nonlinear-solution update  | 1.0E-06                      | 1.0E-06                      |
| MAXSTEP  | Maximum number of Newton steps  | 200                          | 20                           |
| MAXSEARCHSTEP  | Maximum number of line-search steps   | 2                            | 2                            |
| NORMLVL  | Norm level used by the nonlinear solver algorithms ( <i>NOTE: not used for convergence tests</i> )  | 2                            | 2                            |

| Nonlinear Solver<br>(PKG = NONLIN)<br>and (PKG =<br>NONLIN-TRAN)<br>Tags | Description   | NONLIN<br>Default | NONLIN-TRAN<br>Default |
|--|---|-------------------|------------------------|
| IN_FORCING   | Inexact Newton-Krylov forcing flag  | 0 (FALSE)         | 0 (FALSE)              |
| AZ_TOL   | Sets the minimum allowed linear solver tolerance. Valid only if IN_FORCING=1.   | 1.0E-12           | 1.0E-12                |
| RECOVERYSTEPTYPE   | <p>If using a line search, this option determines the type of step to take if the line search fails. Supported strategies:</p> <ul style="list-style-type: none"> <li>■ 0 (Take the last computed step size in the line search algorithm)</li> <li>■ 1 (Take a constant step size set by RECOVERYSTEP)</li> </ul> | 0                 | 0                      |
| RECOVERYSTEP   | Value of the recovery step if a constant step length is selected  | 1.0               | 1.0                    |
| DLSDEBUG   | Debug output for direct linear solver   | 0 (FALSE)         | 0 (FALSE)              |
| DEBUGLEVEL   | The higher this number, the more info is output   | 1                 | 1                      |

| Nonlinear Solver<br>(PKG = NONLIN)<br>and (PKG =<br>NONLIN-TRAN)<br>Tags | Description  | NONLIN<br>Default                              | NONLIN-TRAN<br>Default |
|--|--|--|------------------------|
| DEBUGMINTIMESTEP   | First time-step debug information is output                                      | 0  | 0                      |
| DEBUGMAXTIMESTEP   | Last time-step of debug output   | 99999999                                       | 99999999               |
| DEBUGMINTIME   | Same as DEBUGMINTIMESTEP except controlled by time (sec.) instead of step number | 0.0  | 0.0                    |
| DEBUGMAXTIME   | Same as DEBUGMAXTIMESTEP except controlled by time (sec.) instead of step number | 1.0E+99  | 1.0E+99                |
| <b><i>Parameters not supported by NOX</i></b>                            |  |  |                        |
| LINOPT   | Linear optimization flag   | 0 (FALSE)                                      | 0 (FALSE)              |
| CONSTRAINTBT   | Constraint backtracking flag   | 0 (FALSE)                                      | 0 (FALSE)              |
| CONSTRAINTMAX  | Global maximum setting for constraint backtracking                               | DBL_MAX<br>(Machine<br>Dependent<br>Constant)  | DBL_MAX                |
| CONSTRAINTMIN  | Global minimum setting for constraint backtracking                               | -DBL_MAX<br>(Machine<br>Dependent<br>Constant) | -DBL_MAX               |

| Nonlinear Solver<br>(PKG = NONLIN)<br>and (PKG =<br>NONLIN-TRAN)<br>Tags | Description  | NONLIN<br>Default                                   | NONLIN-TRAN<br>Default |
|--|--|---|------------------------|
| CONSTRAINTCHANGE   | Global percentage-change setting for constraint backtracking | sqrt(DBL_MAX)<br>(Machine<br>Dependent<br>Constant) | sqrt(DBL_MAX)          |

Table 2.5: Options for Nonlinear Solver Package.

### Continuation and Bifurcation Tracking Package Options

The continuation selections listed in Table 2.6 provide methods for controlling continuation and bifurcation analysis. These override the defaults and any that were set simply in the continuation package. This option block is only used if the nonlinear solver or transient nonlinear solver enable continuation through the CONTINUATION flag.

| Continuation and<br>Bifurcation (PKG =<br>LOCA) Tag | Description  | Default     |
|---|--|-------------|
| STEPPER   | Stepping algorithm to use:<br><br><ul style="list-style-type: none"> <li>■ 0 (Natural or Zero order continuation)</li> <li>■ 1 (Arc-length continuation)</li> </ul>    | 0 (Natural) |
| PREDICTOR   | Predictor algorithm to use:<br><br><ul style="list-style-type: none"> <li>■ 0 (Tangent)</li> <li>■ 1 (Secant)</li> <li>■ 2 (Random)</li> <li>■ 3 (Constant)</li> </ul> | 0 (Tangent) |

| Continuation and Bifurcation (PKG = LOCA) Tag | Description   | Default      |
|---|---|--------------|
| STEPCONTROL                                   | Algorithm used to adjust the step size between continuation steps:<br><ul style="list-style-type: none"> <li>■ 0 (Constant)</li> <li>■ 1 (Adaptive)</li> </ul>                                  | 0 (Constant) |
| CONPARAM                                      | Parameter in which to step during a continuation run  | VA:V0        |
| INITIALVALUE                                  | Starting value of the continuation parameter  | 0.0          |
| MINVALUE                                      | Minimum value of the continuation parameter   | -1.0E20      |
| MAXVALUE                                      | Maximum value of the continuation parameter   | 1.0E20       |
| BIFPARAM                                      | Parameter to compute during bifurcation tracking runs   | VA:V0        |
| MAXSTEPS                                      | Maximum number of continuation steps (includes failed steps)  | 20           |
| MAXNLITERS                                    | Maximum number of nonlinear iterations allowed (set this parameter equal to the MAXSTEP parameter in the NONLIN option block)   | 20           |
| INITIALSTEPSIZE                               | Starting value of the step size   | 1.0          |
| MINSTEPSIZE                                   | Minimum value of the step size  | 1.0E20       |
| MAXSTEPSIZE                                   | Maximum value of the step size  | 1.0E-4       |
| AGGRESSIVENESS                                | Value between 0.0 and 1.0 that determines how aggressive the step size control algorithm should be when increasing the step size. 0.0 is a constant step size while 1.0 is the most aggressive. | 0.0          |

Table 2.6: Options for Continuation and Bifurcation Tracking Package.

## Linear Solver Options

**Xyce** uses both sparse-direct solvers as well as Krylov iterative methods for the solution of the linear equations generated by Newton’s method. For the advanced users, there are a variety of options that can be set to help improve these solvers. Many of these options (for the Krylov solvers) are simply passed through to the underlying Trilinos/AztecOO solution settings and thus have an “AZ\_” prefix on the flag; the “AZ\_” options are all case-sensitive. The list in Table 2.7 only provides a partial list of the more commonly used Trilinos/AztecOO options. For a full list of the available options, please see the Aztec User’s Guide [4] available for download at <http://www.cs.sandia.gov/CRF/aztec1.html>. However, for most users, the default options should prove adequate.

| Linear Solver (PKG = LINSOL) Tag | Description  | Default                                     |
|----------------------------------|--|---|
| type                             | <p>Determines which linear solver will be used.</p> <ul style="list-style-type: none"> <li>■ SUPERLU</li> <li>■ KLU</li> <li>■ AZTECOO</li> </ul> <p>Note that while SuperLU and KLU are available for parallel execution they will solve the linear system in serial. Therefore they will be useful for moderate problem sizes but will not scale in memory or performance for large problems</p> | <p>KLU (Serial)<br/>AZTECOO (Parallel)</p>  |
| TR_partition                     | Perform load-balance partitioning on the linear system   | 0 (NONE, Serial)<br>2 (Isorropia, Parallel) |
| TR_partition_type                | Type of load-balance partitioning on the linear system   | ”GRAPH”                                     |
| TR_singleton_filter              | Triggers use of singleton filter for linear system   | 0 (FALSE)                                   |
| TR_amd                           | Triggers use of approximate minimum-degree (AMD) ordering for linear system  | 0 (FALSE, Serial)<br>1 (TRUE, Parallel)     |



| Linear Solver (PKG = LINSOL) Tag                 | Description  | Default            |
|--|--|--------------------|
| TR_global_btf                                    | Triggers use of block triangular form (BTF) ordering for linear system, requires TR_amd=0 and TR_partition=0 | 0 (FALSE)          |
| TR_reindex                                       | Reindexes linear system parallel global indices in lexicographical order, recommended with singleton filter  | 1 (TRUE)           |
| TR_solvermap                                     | Triggers remapping of column indices for parallel runs, recommended with singleton filter                    | 1 (TRUE)           |
| <b><i>Iterative linear solver parameters</i></b> |  |                    |
| adaptive_solve                                   | Triggers use of AztecOO adaptive solve algorithm for preconditioning of iterative linear solves              | 0 (FALSE)          |
| use_aztec_precond                                | Triggers use of native AztecOO preconditioners for the iterative linear solves                               | 0 (FALSE)          |
| AZ_max_iter                                      | Maximum number of iterative solver iterations  | 500                |
| AZ_precond                                       | AztecOO iterative solver preconditioner flag (used only when use_aztec_precond=1)                            | AZ_dom_decomp (14) |
| AZ_solver  | Iterative solver type  | AZ_gmres (1)       |
| AZ_conv  | Convergence type   | AZ_r0 (0)          |
| AZ_pre_calc                                      | Type of precalculation   | AZ_recalc (1)      |
| AZ_keep_info                                     | Retain calculation info  | AZ_true (1)        |
| AZ_orthog  | Type of orthogonalization  | AZ_modified (1)    |
| AZ_subdomain_solve                               | Subdomain solution for domain decomposition preconditioners  | AZ_ilut (9)        |
| AZ_ilut_fill                                     | Approximate allowed fill-in factor for the ILUT preconditioner   | 2.0                |

| Linear Solver (PKG = LINSOL) Tag | Description  | Default                              |
|----------------------------------|--|--------------------------------------|
| AZ_drop                          | Specifies drop tolerance used in conjunction with LU or ILUT preconditioners | 1.0E-03                              |
| AZ_reorder                       | Reordering type  | AZ_none (0)                          |
| AZ_scaling                       | Type of scaling  | AZ_none (0)                          |
| AZ_kspace                        | Maximum size of Krylov subspace  | 500                                  |
| AZ_tol                           | Convergence tolerance  | 1.0E-12                              |
| AZ_output                        | Output level   | AZ_none (0)<br>50 (if verbose build) |
| AZ_diagnostics                   | Diagnostic information level   | AZ_none (0)                          |
| AZ_overlap                       | Schwarz overlap level for ILU preconditioners                                | 0                                    |
| AZ_rthresh                       | Diagonal shifting relative threshold for ILU preconditioners                 | 1.0001                               |
| AZ_athresh                       | Diagonal shifting absolute threshold for ILU preconditioners                 | 1.0E-04                              |

Table 2.7: Options for Linear Solver Package.

## Output Options

The main purpose of the .OPTIONS OUTPUT command is to allow control of the output frequency of data to files specified by .PRINT TRAN commands. The format is:

```
.OPTIONS OUTPUT INITIAL_INTERVAL=<interval> [<t0> <i0> [<t1> <i1>...]]
```

where INITIAL\_INTERVAL=<interval> specifies the starting interval time for output and <tx> <ix> specifies later simulation times <tx> where the output interval will change to <ix>.

**Note:** In all recent versions of Xyce the solution is output at the exact intervals requested; this is done by interpolating the solution to the requested time points.

## Checkpointing and Restarting Options

The `.OPTIONS RESTART` command is used to control all checkpoint output and restarting.

■ Checkpointing command format:

```
.OPTIONS RESTART [PACK=<0|1>] JOB=<job prefix>
+ [INITIAL_INTERVAL=<initial interval time>
+ [<t0> <i0> [<t1> <i1>...]]]
```

`PACK=<0|1>` indicates whether the restart data will be byte packed or not. Parallel restarts must always be packed while currently Windows/MingW runs are always not packed. Otherwise, by default data will be packed unless explicitly specified. `JOB=<job prefix>` identifies the prefix for restart files. The actual restart files will be the job name with the current simulation time appended (e.g. `name1e-05` for `JOB=name` and simulation time `1e-05` seconds). Furthermore, `INITIAL_INTERVAL=<initial interval time>` identifies the initial interval time used for restart output. The `<tx> <ix>` intervals identify times `<tx>` at which the output interval (`ix`) should change. This functionality is identical to that described for the `.OPTIONS OUTPUT` command.

To generate checkpoints at every time step (default):

**Example:** `.OPTIONS RESTART JOB=checkpt`

To generate checkpoints every  $0.1 \mu s$ :

**Example:** `.OPTIONS RESTART JOB=checkpt INITIAL_INTERVAL=0.1us`

To generate unpacked checkpoints every  $0.1 \mu s$ :

**Example:** `.OPTIONS RESTART PACK=0 JOB=checkpt INITIAL_INTERVAL=0.1us`

To specify an initial interval of  $0.1 \mu s$ , at  $1 \mu s$  change to interval of  $0.5 \mu s$ , and at  $10 \mu s$  change to interval of  $0.1 \mu s$ :

**Example:**

```
.OPTIONS RESTART JOB=checkpt INITIAL_INTERVAL=0.1us 1.0us
+ 0.5us 10us 0.1us
```

To restart from an existing restart file, specify the file by either `FILE=<restart file name>` to explicitly use a restart file or by `JOB=<job name> START_TIME=<specified name>` to specify a file prefix and a specified time. The time must exactly match an output file time for the simulator to correctly identify the correct file. To continue generating restart output files, `INITIAL_INTERVAL=<interval>` and following intervals can be appended to the command in the same format as described above. New restart files will be packed according to the previous restart file read in. Here are several examples:

■ Restarting command format:

```
.OPTIONS RESTART <FILE=<restart file name> |
+ JOB=<job name> START_TIME=<time>>
+ [ INITIAL_INTERVAL=<interval> [<t0> <i0> [<t1> <i1> ...]]]
```

Example restarting from checkpoint file at 0.133  $\mu$ s:

**Example:** `.OPTIONS RESTART JOB=checkpt START_TIME=0.133us`

To restart from checkpoint file at 0.133  $\mu$ s:

**Example:** `.OPTIONS RESTART FILE=checkpt0.000000133`

Restarting from 0.133  $\mu$ s and continue checkpointing at 0.1  $\mu$ s intervals:

**Example:**

```
.OPTIONS RESTART FILE=checkpt0.000000133 JOB=checkpt_again
+ INITIAL_INTERVAL=0.1us
```

## Restart with two-level

Large parallel problems which involve power supply parasitics often require a two-level solve, in which different parts of the problem are handled separately. In most respects, restarting a two-level simulation is similar to restarting a conventional simulation. However, there are a few differences:

- When running with a two-level algorithm, **Xyce** requires (at least) two different input

files. In order to do a restart of a two-level **Xyce** simulation, it is necessary to have an `.OPTIONS RESTART` statement in each file.

- It is necessary for the statements to be consistent. For example, the output times must be exactly the same, meaning the initial intervals must be exactly the same.
- Currently, **Xyce** will *not* check to make sure that the restart options used in different files match, so it is up to the user to insure matching options.
- Finally, as each netlist that is part of a two-level solve will have its own `.OPTIONS RESTART` statement, that means that each netlist will generate and/or use its own set of restart files. As a result, the restart file name used by each netlist must be unique.

## .PREPROCESS Statements

### .PREPROCESS (Netlist Preprocessing)

Used to automatically augment a netlist to remove/add/change certain features before a **Xyce** simulation begins. Generally takes the form

```
.PREPROCESS <KEYWORD> <VALUE> [<VALUE>]*
```

We describe each of the three main functionalities of `.PREPROCESS` statements below

### Ground Synonym Replacement

The purpose of ground synonym replacement is to treat nodes with the names `GND`, `GND!`, `GROUND`, etc. as synonyms for node 0. The general invocation is

```
.PREPROCESS REPLACEGROUND <BOOL>
```

where `<BOOL>` is either `TRUE` or `FALSE`. If `TRUE`, **Xyce** will treat all instances of `GND`, `GND!`, `GROUND`, etc. as synonyms for node 0 but, if `FALSE`, **Xyce** will treat these nodes as separate. Only one `.PREPROCESS REPLACEGROUND` statement is permissible in a given netlist file.

## Removal of Unused Components

If a given netlist file contains devices whose terminals are all connected to the same node (e.g., R2 1 1 1M), it may be desirable to remove such components from the netlist before simulation begins. This is the purpose of the command

```
.PREPROCESS REMOVEUNUSED [<VALUE>]
```

where <VALUE> is a list of components separated by commas. As an example, the command

```
.PREPROCESS REMOVEUNUSED R,C
```

will attempt to search for all resistors and capacitors in a given netlist file whose individual device terminals are connected to the same node and remove these components from the netlist before simulation ensues. A list of components which are currently supported for removal is given in Table 2.8. Note that for MOSFETS and BJTs, three terminals on each device (the gate, source, and drain in the case of a MOSFET and the collector, base, and emitter in the case of a BJT) must be the same for the device to be removed from the netlist. As before, only one `.PREPROCESS REMOVEUNUSED` line is allowed in a given netlist file.

| Keyword | Device Type                |
|---------|----------------------------|
| C       | Capacitor                  |
| D       | Diode                      |
| I       | Independent Current Source |
| L       | Inductor                   |
| M       | MOSFET                     |
| Q       | BJT                        |
| R       | Resistor                   |
| V       | Independent Voltage Source |

Table 2.8: List of keywords and device types which can be used in a `.PREPROCESS REMOVEUNUSED` statement.

## Adding Resistors to Dangling Nodes

We refer to a *dangling node* as a circuit node in one of the following two scenarios: either the node is connected to only one device terminal, and/or the node has no DC path to

ground. If several such nodes exist in a given netlist file, it may be desirable to automatically append a resistor of a specified value between the dangling node and ground. To add resistors to nodes which are connected to only one device terminal, one may use the command

```
.PREPROCESS ADDRESISTORS ONETERMINAL <VALUE1>
```

where <VALUE1> is the value of the resistor to be placed between nodes with only one device terminal connection and ground. For instance, the command

```
.PREPROCESS ADDRESISTORS ONETERMINAL 1G
```

will add resistors of value 1G between ground and nodes with only one device terminal connection and ground. The command

```
.PREPROCESS ADDRESISTORS NODCPATH <VALUE2>
```

acts similarly, adding resistors of value <VALUE2> between ground and all nodes which have no DC path to ground.

The `.PREPROCESS ADDRESISTORS` command is functionally different from either of the prior `.PREPROCESS` commands in the following way: while the other commands augment the netlist file for the current simulation, a `.PREPROCESS ADDRESISTORS` statement creates an auxiliary netlist file which explicitly contains a set of resistors that connect dangling nodes to ground. If the original netlist file containing a `.PREPROCESS ADDRESISTORS` statement is called `filename`, invoking **Xyce** on this file will produce a file `filename_xyce.cir` which contains the resistors that connect dangling nodes to ground. One can then run **Xyce** on this file to run a simulation in which the dangling nodes are tied to ground. Note that, in the original run on the file `filename`, **Xyce** will continue to run a simulation as usual after producing the file `filename_xyce.cir`, but this simulation will *not* include the effects of adding resistors between the dangling nodes and ground. Refer to the **Xyce** User's Guide for more detailed examples on the use of `.PREPROCESS ADDRESISTOR` statements.

Note that it is possible for a node to have one device terminal connection and, simultaneously, have no DC path to ground. In this case, if both a `ONETERMINAL` and `NODCPATH` command are invoked, only the resistor for the `ONETERMINAL` connection is added to the netlist; the `NODCPATH` connection is omitted.

As before, each netlist file is allowed to contain only one `.PREPROCESS ADDRESSISTORS ONETERMINAL` and one `.PREPROCESS ADDRESSISTORS NODCPATH` line each, or else **Xyce** will exit in error.

## 2.2 Analog Devices

**Xyce** supports many analog devices, including sources, subcircuits and behavioral models. This section serves as a reference for the analog devices supported by **Xyce**. Each device is described separately and includes the following information, if applicable:

- a description and an example of the correct netlist syntax.
- the matching model types and their description.
- the matching list of model parameters and associated descriptions.
- the corresponding and characteristic equations for the model (as required).
- references to publications on which the model is based.

You can also create models and macromodels using the `.MODEL` (model definition) and `.SUBCKT` (subcircuit) statements, respectively.

Please note that the characteristic equations are provided to give a general representation of the device behavior. The actual **Xyce** implementation of the device may be slightly different in order to improve, for example, the robustness of the device.

Table 2.9 gives a summary of the analog device types and the form of their netlist formats. Each of these is described below in detail.

| Device Type                           | Designator Letter | Typical Netlist Format   |
|---------------------------------------|-------------------|--|
| Nonlinear Dependent Source (B Source) | B                 | B<name> <+ node> <- node><br>+ <I or V>={<expression>}                   |
| Capacitor                             | C                 | C<name> <+ node> <- node> [model name] <value><br>+ [IC=<initial value>] |
| Diode                                 | D                 | D<name> <anode node> <cathode node><br>+ <model name> [area value]       |



| Device Type                       | Designator Letter | Typical Netlist Format  |
|-----------------------------------|-------------------|---|
| Voltage Controlled Voltage Source | E                 | E<name> <+ node> <- node> <+ controlling node><br>+ <- controlling node> <gain>   |
| Current Controlled Current Source | F                 | F<name> <+ node> <- node><br>+ <controlling V device name> <gain>   |
| Voltage Controlled Current Source | G                 | G<name> <+ node> <- node> <+ controlling node><br>+ <- controlling node> <transconductance>   |
| Current Controlled Voltage Source | H                 | H<name> <+ node> <- node><br>+ <controlling V device name> <gain>   |
| Independent Current Source        | I                 | I<name> <+ node> <- node> [[DC] <value>]<br>+ [transient specification]   |
| Mutual Inductor                   | K                 | K<name> <inductor 1> [<ind. n>*]<br>+ <linear coupling or model>  |
| Inductor                          | L                 | L<name> <+ node> <- node> [model name] <value><br>+ [IC=<initial value>]  |
| JFET                              | J                 | J<name> <drain node> <gate node> <source node><br>+ <model name> [area value]   |
| MOSFET                            | M                 | M<name> <drain node> <gate node> <source node><br>+ <bulk/substrate node> [SOI node(s)]<br>+ <model name> [common model parameter]* |
| Bipolar Junction Transistor (BJT) | Q                 | Q<name> <collector node> <base node><br>+ <emitter node> [substrate node]<br>+ <model name> [area value]                            |
| Resistor                          | R                 | R<name> <+ node> <- node> [model name] <value><br>+ [L=<length>] [W=<width>]  |
| Voltage Controlled Switch         | S                 | S<name> <+ switch node> <- switch node><br>+ <+ controlling node> <- controlling node><br>+ <model name>                            |
| Transmission Line                 | T                 | T<name> <A port + node> <A port - node><br>+ <B port + node> <B port - node><br>+ <ideal specification>                             |
| Independent Voltage Source        | V                 | V<name> <+ node> <- node> [[DC] <value>]<br>+ [transient specification]   |
| Subcircuit                        | X                 | X<name> [node]* <subcircuit name><br>+ [PARAMS: [<name>=<value>]*]  |
| Current Controlled Switch         | W                 | W<name> <+ switch node> <- switch node><br>+ <controlling V device name> <model name>   |

| Device Type     | Designator Letter | Typical Netlist Format  |
|-----------------|-------------------|---|
| Digital Devices | Y<name>           | Y<name> [node]* <model name>  |
| PDE Devices     | YPDE              | YPDE <name> [node]* <model name>  |
| ROM Devices     | YROM              | YROM <name> <+ node> <- node><br>+ BASE_FILENAME=<filename><br>+ [MASK_VARS=<true/false>] |
| MESFET          | Z                 | Z<name> <drain node> <gate node> <source node><br>+ <model name> [area value]             |

Table 2.9: Analog Device Quick Reference.

## Voltage Nodes

Devices in a netlist are connected between *nodes*, and all device types in **Xyce** require at least two nodes on each instance line. Node names can consist of any printable characters *except* white space (space, tab, newline), parentheses (“(“ or “)”), braces (“{“ or “}”), commas, or the equal sign.

Except for global nodes (below), voltage node names appearing in a subcircuit that are not listed in the subcircuit’s argument list are accessible only to that subcircuit; devices outside the subcircuit cannot connect to local nodes.

### Global nodes

A special syntax is used to designate certain nodes as *global* nodes. Any node whose name starts with the two characters “\$G” is a global node, and such nodes are available to be used in any subcircuit. A typical usage of such global nodes is to define a VDD or VSS signal that all subcircuits need to be able to access, but without having to provide VSS and VDD input nodes to every subcircuit. In this case, a global \$GVDD node would be use for the VDD signal.

The node named 0 is a special global node. Node 0 is always ground, and is accessible to all levels of a hierarchical netlist.

# Capacitor

---

**General Form** C<name> <(+) node> <(-) node> [model name] [value] [device parameters]

---

**Examples**

```
CM12 2 4 5.288e-13
CLOAD 1 0 4.540pF IC=1.5V
CFEEDBACK 2 0 CMOD 1.0pF
CAGED 2 3 4.0uF D=0.0233 AGE=86200
```

**Symbol**



**Model Form**

.MODEL <model name> C [model parameters]

---

(+) and (-) nodes

Polarity definition for a positive voltage across the capacitor. The first node is defined as positive. Therefore, the voltage across the component is the first node voltage minus the second node voltage.

[model name]

If [model name] is omitted, then <value> is the capacitance in farads. If [model name] is given then the value is determined from the model parameters; see the capacitor value formula below.

**Parameters and Options**

[value]

Positional specification of device parameter C (capacitance). Alternately, this can be specified as a parameter, C=<value>, or in the (optional) model.

[device parameters]

Parameters listed in Table 2.10 may be provided as space separated <parameter>=<value> specifications as needed. Any number of parameters may be specified.

---

---

Positive current flows through the capacitor from the (+) node to the (-) node. In general, capacitors should have a positive capacitance value (<value> property). In all cases, the capacitance must not be zero.

**Comments**

However, cases exist when a negative capacitance value may be used. This occurs most often in filter designs that analyze an RLC circuit equivalent to a real circuit. When transforming from the real to the RLC equivalent, the result may contain a negative capacitance value.

In a transient run, negative capacitance values may cause the simulation to fail due to instabilities they cause in the time integration algorithms.

---

## Device Parameters

Table 2.10 gives the available device parameters for the capacitor.

| Parameter | Description                        | Units | Default |
|-----------|------------------------------------|-------|---------|
| AGE       | Age of capacitor                   | hour  | 0       |
| C         | Capacitance                        | F     | 1       |
| D         | Age degradation coefficient        | –     | 0.0233  |
| IC        | Initial voltage drop across device | V     | 0       |
| L         | Semiconductor capacitor width      | m     | 1       |
| TEMP      | Device temperature                 | °C    | 27      |
| W         | Semiconductor capacitor length     | m     | 1e-06   |

Table 2.10: Capacitor Device Parameters.

## Model Parameters

Table 2.11 gives the available model parameters for the capacitor.

| Parameter | Description                   | Units            | Default |
|-----------|-------------------------------|------------------|---------|
| CJ        | Junction bottom capacitance   | F/m <sup>2</sup> | 0       |
| CJSW      | Junction sidewall capacitance | F/m              | 0       |
| DEFW      | Default device width          | m                | 1e-06   |

| Parameter | Description                       | Units            | Default |
|-----------|-----------------------------------|------------------|---------|
| NARROW    | Narrowing due to side etching     | m                | 0       |
| TC1       | Linear temperature coefficient    | °C <sup>-1</sup> | 0       |
| TC2       | Quadratic temperature coefficient | °C <sup>-2</sup> | 0       |
| TNOM      | Nominal device temperature        | °C               | 27      |

Table 2.11: Capacitor Model Parameters.

## Capacitor Equations

### Capacitance Value Formula

If [model name] is specified, then the capacitance is given by:

$$C \cdot (1 + \mathbf{TC1} \cdot (T - T_0) + \mathbf{TC2} \cdot (T - T_0)^2)$$

where  $C$  is the base capacitance specified on the device line and is normally positive (though it can be negative, but not zero).  $T_0$  is the nominal temperature (set using **TNOM** option).

### Age-aware Formula

If **AGE** is given, then the capacitance is:

$$C[1 - \mathbf{D} \log(\mathbf{AGE})]$$

### Semiconductor Formula

If [model name] and **L** and **W** are given, then the capacitance is:

$$CJ(\mathbf{L} - \mathbf{NARROW})(\mathbf{W} - \mathbf{NARROW}) + 2 \cdot CJSW(\mathbf{L} - \mathbf{W} + 2 \cdot \mathbf{NARROW})$$

## Inductor

|                               |   |
|-------------------------------|---|
| <b>General Form</b>           | L<name> <(+) node> <(-) node> [model] <value><br>+ [IC=<initial value>]   |
| <b>Examples</b>               | L1 1 5 3.718e-08<br>LLOAD 3 6 4.540mH IC=2mA<br>Lmodded 3 6 indmod 4.540mH<br>.model indmod L (L=.5 TC1=0.010 TC2=0.0094)   |
| <b>Symbol</b>                 |    |
| <b>Model Form</b>             | .MODEL <model name> L [model parameters]  |
| <b>Parameters and Options</b> | (+) and (-) nodes<br><br>Polarity definition for a positive voltage across the inductor. The first node is defined as positive. Therefore, the voltage across the component is the first node voltage minus the second node voltage.<br><br><initial value><br><br>The initial current through the inductor during the bias point calculation.  |
| <b>Comments</b>               | In general, inductors should have a positive inductance value (VALUE property). In all cases, the inductance must not be zero. However, cases exist when a negative value may be used. This occurs most often in filter designs that analyze an RLC circuit equivalent to a real circuit. When transforming from the real to the RLC equivalent, the result may contain a negative inductance value.<br><br>If a model name is given, the inductance is modified from the value given on the instance line by the parameters in the model card. See "Inductance Value Formula" below.<br>When an inductor is named in the list of coupled inductors in a mutual inductor device line (see page 81) , and that mutual inductor is of the nonlinear-core type, the <value> is interpreted as a number of turns rather than as an inductance in Henries. |

## Model Parameters

Table 2.12 gives the available model parameters for the inductor.

| Model parameters | Description                       | Units            | Default |
|------------------|-----------------------------------|------------------|---------|
| L                | Inductance Multiplier             |                  | 1.0     |
| TC1              | Linear Temperature Coefficient    | °C <sup>-1</sup> | 0.0     |
| TC2              | Quadratic Temperature Coefficient | °C <sup>-2</sup> | 0.0     |
| TNOM             | Parameter Measurement Temperature | °C               | 27.0    |

Table 2.12: Inductor Model Parameters.

## Inductor Equations

### Inductance Value Formula

If [model name] is specified, then the inductance is given by:

$$L_{base} \cdot L \cdot (1 + TC1 \cdot (T - T_0) + TC2 \cdot (T - T_0)^2)$$

where  $L_{base}$  is the base inductance specified on the device line and is normally positive (though it can be negative, but not zero).  $L$  is the inductance multiplier specified in the model card.  $T_0$  is the nominal temperature (set using **TNOM** option).



## Mutual Inductors

---

**General Form**    K<name> L<inductor name> [L<inductor name>]\* <coupling value>  
                           + [model name]

---

**Examples**            KTUNED L3OUT L4IN .8  
                           KTRNSFRM LPRIMARY LSECNDRY 1  
                           KXFRM L1 L2 L3 L4 .98 KPOT\_3C8

---

**Symbol**

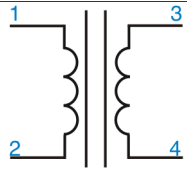

---

**Model Form**        .MODEL <model name> CORE [model parameters]

---

---

L<inductor name> [L<inductor name>\*]

Identifies the inductors to be coupled. The inductors are coupled and in the dot notation the dot is placed on the first node of each inductor. The polarity is determined by the order of the nodes in the L devices and not by the order of the inductors in the K statement.

<coupling value>

The coefficient of mutual coupling, which must be between -1.0 and 1.0.

This coefficient is defined by the equation

$$\text{<coupling value>} = \frac{M_{ij}}{\sqrt{L_i L_j}}$$

where

$L_i$  is the inductance of the  $i$ th named inductor in the K-line

$M_{ij}$  is the mutual inductance between  $L_i$  and  $L_j$

For transformers of normal geometry, use 1.0 as the value. Values less than 1.0 occur in air core transformers when the coils do not completely overlap.

<model name>

If <model name> is present, four things change:

- The mutual coupling inductor becomes a nonlinear, magnetic core device.
  - The inductors become windings, so the number specifying inductance now specifies the number of turns.
  - The list of coupled inductors could be just one inductor.
  - A model statement is required to specify the model parameters.
- 

## **Parameters and Options**

## **Model Parameters**

Table 2.13 gives the available model parameters for mutual inductors.

| Parameter       | Description  | Units           | Default   |
|-----------------|--|-----------------|-----------|
| A               | Thermal energy parameter   | A/m             | 1000      |
| ALPHA           | Domain coupling parameter  | –               | 5e-05     |
| AREA            | Mean magnetic cross-sectional area                               | cm <sup>2</sup> | 1e-05     |
| BETAH           | Modeling constant  | –               | 0.0001    |
| BETAM           | Modeling constant  | –               | 3.125e-05 |
| C               | Domain flesing parameter   | –               | 0.2       |
| DELV            | Smoothing coefficient for voltage difference over first inductor | V               | 0.1       |
| GAP             | Effective air gap  | cm              | 0         |
| K               | Domain anisotropy parameter                                      | A/m             | 500       |
| KIRR            | Domain anisotropy parameter                                      | A/m             | 500       |
| LEVEL           | for pspice compatibility – ignored                               | –               | 0         |
| MEQNSCALING     | M-equation scaling   | –               | 1e-09     |
| MS              | Saturation magnetization   | A/m             | 1e+06     |
| MVARSCALING     | M-variable scaling.  | –               | 1e+09     |
| OUTPUTSTATEVARS | Flag to save state variables                                     | –               | 0         |
| PACK            | for pspice compatibility – ignored                               | –               | 0         |
| PATH            | Total mean magnetic path   | cm              | 0.01      |
| PZEROTOL        | Tolerance for nonlinear zero crossing                            | –               | 0.1       |
| REQNSCALING     | R-equation scaling   | –               | 1e-09     |
| RVARSCALING     | R-variable scaling   | –               | 1e+09     |
| TC1             | First order temperature coeff.                                   | –               | 0         |
| TC2             | Second order temperature coeff.                                  | –               | 0         |
| TNOM            | Reference temperature  | °C              | 27        |
| VINF            | Smoothing coefficient for voltage difference over first inductor | V               | 1         |

Table 2.13: Nonlinear Mutual Inductor Device Model Parameters.

### Special Notes

As of Xyce Release 4.1, the coupling coefficient of the linear mutual inductor (i.e. a mutual inductor without a core model) is permitted to be a time- or solution variable-dependent expression. This is intended to allow simulation of electromechanical devices in which there might be moving coils that interact with fixed coils.

## Resistor

|                               |   |
|-------------------------------|---|
| <b>General Form</b>           | R<name> <(+) node> <(-) node> [model name] [value] [device parameters]  |
| <b>Examples</b>               | <pre> R1 1 2 2K TEMP=27 RLOAD 3 6 RTCMOD 4.540 TEMP=85 .MODEL RTCMOD R (TC1=.01 TC2=-.001) RSEMICOND 2 0 RMOD L=1000u W=1u .MODEL RMOD R (RSH=1) </pre>   |
| <b>Symbol</b>                 |    |
| <b>Model Form</b>             | .MODEL <model name> R [model parameters]  |
|                               | (+) and (-) nodes   |
|                               | <p>Polarity definition for a positive voltage across the resistor. The first node is defined as positive. Therefore, the voltage across the component is the first node voltage minus the second node voltage. Positive current flows from the positive node (first node) to the negative node (second node).</p> |
|                               | [model name]  |
|                               | <p>If [model name] is omitted, then [value] is the resistance in Ohms. If [model name] is given then the resistance is determined from the model parameters; see the resistance value formula below.</p>  |
| <b>Parameters and Options</b> | [value]   |
|                               | <p>Positional specification of device parameter R (resistance). Alternately, this can be specified as a parameter, R=&lt;value&gt;, or in the (optional) model.</p>   |
|                               | [device parameters]   |
|                               | <p>Parameters listed in Table 2.14 may be provided as space separated &lt;parameter&gt;=&lt;value&gt; specifications as needed. Any number of parameters may be specified.</p>  |
| <b>Comments</b>               | Resistors must have a positive (nonzero) resistance value (R)   |

## Device Parameters

Table 2.14 gives the available device parameters for the resistor.

| Parameter | Description | Units              | Default |
|-----------|-------------|--------------------|---------|
| L         | Length      | m                  | 0       |
| R         | Resistance  | $\Omega$           | 1000    |
| TEMP      | Temperature | $^{\circ}\text{C}$ | 27      |
| W         | Width       | m                  | 1e-05   |

Table 2.14: Resistor Device Parameters.

## Model Parameters

Table 2.15 gives the available model parameters for the resistor.

| Parameter | Description                       | Units                   | Default |
|-----------|-----------------------------------|-------------------------|---------|
| DEFW      | Default Instance Width            | m                       | 1e-05   |
| NARROW    | Narrowing due to side etching     | m                       | 0       |
| RSH       | Sheet Resistance                  | $\Omega$                | 0       |
| TC1       | Linear Temperature Coefficient    | $^{\circ}\text{C}^{-1}$ | 0       |
| TC2       | Quadratic Temperature Coefficient | $^{\circ}\text{C}^{-2}$ | 0       |
| TNOM      | Parameter Measurement Temperature | $^{\circ}\text{C}$      | 27      |

Table 2.15: Resistor Model Parameters.

## Resistor Equations

### Resistance Value Formula

If [model name] is included, then the resistance is:

$$R \cdot (1 + \text{TC1} \cdot (T - T_0) + \text{TC2} \cdot (T - T_0)^2)$$

If L and W are given, the resistance is:

$$RSH \frac{[L - \text{NARROW}]}{[W - \text{NARROW}]}$$

## Thermal (level=2) Resistor

Xyce supports a thermal resistor model, which is associated with level=2.

### Thermal Resistor Instance Parameters

Table 2.16 gives the available instance parameters for the thermal (level=2) resistor.

| Parameter            | Description   | Units                 | Default |
|----------------------|---|-----------------------|---------|
| A                    | Area of conductor   | m <sup>2</sup>        | 0       |
| DENSITY              | Resistor material density (unused)                                  | kg/m <sup>3</sup>     | 0       |
| HEATCAPACITY         | Resistor material volumetric heat capacity                          | J/(m <sup>3</sup> °K) | 0       |
| L                    | Length of conductor   | m                     | 0       |
| OUTPUTINTVARS        | Debug Output switch   | –                     | False   |
| R                    | Resistance  | Ω                     | 1000    |
| RESISTIVITY          | Resistor material resistivity                                       | Ω-m                   | 0       |
| TEMP                 | Temperature   | °C                    | 27      |
| THERMAL_A            | Area of material thermally coupled to conductor                     | m <sup>2</sup>        | 0       |
| THERMAL_HEATCAPACITY | Volumetric heat capacity of material thermally coupled to conductor | J/(m <sup>3</sup> °K) | 0       |
| THERMAL_L            | Length of material thermally coupled to conductor                   | m                     | 0       |
| W                    | Width of conductor  | m                     | 1e-05   |

Table 2.16: Resistor Device Instance Parameters.

### Thermal Resistor Model Parameters

Table 2.17 gives the available model parameters for the thermal (level=2) resistor.

| Parameter    | Description                                | Units                 | Default |
|--------------|--|-----------------------|---------|
| DEFW         | Default Instance Width                     | m                     | 1e-05   |
| DENSITY      | Resistor material density (unused)         | kg/m <sup>3</sup>     | 0       |
| HEATCAPACITY | Resistor material volumetric heat capacity | J/(m <sup>3</sup> °K) | 0       |
| NARROW       | Narrowing due to side etching              | m                     | 0       |

| Parameter            | Description   | Units                    | Default |
|----------------------|---|--------------------------|---------|
| RESISTIVITY          | Resistor material resistivity                                       | $\Omega\text{-m}$        | 0       |
| RSH                  | Sheet Resistance  | $\Omega$                 | 0       |
| TC1                  | Linear Temperature Coefficient                                      | $^{\circ}\text{C}^{-1}$  | 0       |
| TC2                  | Quadratic Temperature Coefficient                                   | $^{\circ}\text{C}^{-2}$  | 0       |
| THERMAL_HEATCAPACITY | Volumetric heat capacity of material thermally coupled to conductor | $J/(\text{m}^3\text{K})$ | 0       |
| TNOM                 | Parameter Measurement Temperature                                   | $^{\circ}\text{C}$       | 27      |

Table 2.17: Resistor Device Model Parameters.



## Diode

|                     |  |
|---------------------|--|
| <b>General Form</b> | D<name> <(+) node> <(-) node> <model name> [area value]  |
| <b>Examples</b>     | DCLAMP 1 0 DMOD<br>D2 15 17 SWITCH 1.5   |
| <b>Symbol</b>       |   |
| <b>Model Form</b>   | .MODEL <model name> D [model parameters]<br><(+) node><br>The anode.<br><(-) node><br>The cathode.<br>[area value]<br>Scales IS, ISR, IKF, RS, CJO, and IBV, and has a default value of 1. IBV and BV are both specified as positive values. |
| <b>Comments</b>     | The diode is modeled as an ohmic resistance ( $R_S/area$ ) in series with an intrinsic diode. Positive current is current flowing from the anode through the diode to the cathode.   |

### Diode Operating Temperature

Model parameters can be assigned unique measurement temperatures using the **TNOM** model parameter.

### Diode level selection

Two distinct implementations of the diode are available. These are selected by using the **LEVEL** model parameter. The default implementation is based on SPICE 3F5, and may be explicitly specified using **LEVEL=1** in the model parameters, but is also selected if no **LEVEL** parameter is specified. The PSpice implementation [2] is obtained by specifying **LEVEL=2**.

The **Xyce** **LEVEL=1** and **LEVEL=2** diodes have a parameter, **IRF**, that allows the user to adjust the reverse current from the basic SPICE implementation. The usual SPICE treatment defines the linear portion of the reverse current in terms of **IS** which is defined by the

forward current characteristics. Data shows that often the reverse current is quite far off when determined in this manner. The parameter **IRF** is a multiplier that can be applied to adjust the linear portion of the reverse current.

## Device Parameters

Table 2.18 gives the available device parameters for the diode.

| Parameter | Description   | Units         | Default |
|-----------|---|---------------|---------|
| AREA      | Area scaling value (scales IS, ISR, IKF, RS, CJO, and IBV)  | –             | 1       |
| IC        | Initial voltage drop across device                          | V             | 0       |
| LAMBERTW  | Option to solve diode equations with the Lambert-W function | logical (T/F) | 0       |
| OFF       | Initial voltage drop across device set to zero              | logical (T/F) | 0       |
| TEMP      | Device temperature  | °C            | 27      |

Table 2.18: Diode Device Parameters.

## Model Parameters

Table 2.19 gives the available model parameters for the LEVEL=1 and LEVEL=2 diodes.

| Parameter | Description  | Units | Default |
|-----------|--|-------|---------|
| AF        | Flicker noise exponent                               | –     | 1       |
| BV        | Reverse breakdown "knee" voltage                     | V     | 1e+99   |
| CJO       | Zero-bias p-n depletion capacitance                  | F     | 0       |
| EG        | Bandgap voltage (barrier height)                     | eV    | 1.11    |
| FC        | Forward-bias depletion capacitance coefficient       | –     | 0.5     |
| IBV       | Reverse breakdown "knee" current                     | A     | 0.001   |
| IBVL      | Low-level reverse breakdown "knee" current (level 2) | A     | 0       |
| IKF       | High-injection "knee" current (level 2)              | A     | 0       |
| IRF       | Reverse current fitting factor                       | –     | 1       |
| IS        | Saturation current                                   | A     | 1e-14   |
| ISR       | Recombination current parameter (level 2)            | A     | 0       |

| Parameter | Description   | Units                   | Default |
|-----------|---|-------------------------|---------|
| KF        | Flicker noise coefficient                             | –                       | 0       |
| M         | Grading parameter for p-n junction                    | –                       | 0.5     |
| N         | Emission coefficient                                  | –                       | 1       |
| NBV       | Reverse breakdown ideality factor (level 2)           | –                       | 1       |
| NBVL      | Low-level reverse breakdown ideality factor (level 2) | –                       | 1       |
| NR        | Emission coefficient for ISR (level 2)                | –                       | 2       |
| RS        | Parasitic resistance                                  | $\Omega$                | 0       |
| TBV1      | BV temperature coefficient (linear) (level 2)         | $^{\circ}\text{C}^{-1}$ | 0       |
| TBV2      | BV temperature coefficient (quadratic) (level 2)      | $^{\circ}\text{C}^{-2}$ | 0       |
| TIKF      | IKF temperature coefficient (linear) (level 2)        | $^{\circ}\text{C}^{-1}$ | 0       |
| TNOM      | Nominal device temperature                            | $^{\circ}\text{C}$      | 27      |
| TRS1      | RS temperature coefficient (linear) (level 2)         | $^{\circ}\text{C}^{-1}$ | 0       |
| TRS2      | RS temperature coefficient (quadratic) (level 2)      | $^{\circ}\text{C}^{-2}$ | 0       |
| TT        | Transit time  | s                       | 0       |
| VJ        | Potential for p-n junction                            | V                       | 1       |
| XTI       | IS temperature exponent                               | –                       | 3       |

Table 2.19: Diode Model Parameters.

## Diode Equations

The equations in this section use the following variables:

$V_{di}$  = voltage across the intrinsic diode only

$V_{th}$  =  $k \cdot T/q$  (thermal voltage)

$k$  = Boltzmann's constant

$q$  = electron charge

$T$  = analysis temperature (Kelvin)

$T_0$  = nominal temperature (set using TNOM option)

$\omega$  = Frequency (Hz)

Other variables are listed above in the diode model parameters.

Level=1

The level 1 diode is based on the Spice3f5 level 1 model.

DC Current (Level=1)

The intrinsic diode current consists of forward and reverse bias regions where

$$I_D = \begin{cases} \mathbf{IS} \cdot \left[ \exp\left(\frac{V_{di}}{\mathbf{NV}_{th}}\right) - 1 \right], & V_{di} > -3.0 \cdot \mathbf{NV}_{th} \\ -\mathbf{IS} \cdot \mathbf{IRF} \cdot \left[ 1.0 + \left(\frac{3.0 \cdot \mathbf{NV}_{th}}{V_{di} \cdot e}\right)^3 \right], & V_{di} < -3.0 \cdot \mathbf{NV}_{th} \end{cases}$$

**IRF** is a **Xyce**-specific parameter that can be used to scale the reverse-biased current to match measured data. It defaults to 1.0, which reduces the model to strict SPICE3F5 compatibility.

When **BV** and an optional parameter **IBV** are explicitly given in the model statement, an exponential model is used to model reverse breakdown (with a “knee” current of **IBV** at a “knee-on” voltage of **BV**). The equation for  $I_D$  implemented by **Xyce** is given by

$$I_D = -\mathbf{IBV}_{\text{eff}} \cdot \exp\left(-\frac{\mathbf{BV}_{\text{eff}} + V_{di}}{\mathbf{NV}_{th}}\right), \quad V_{di} \leq \mathbf{BV}_{\text{eff}},$$

where  $\mathbf{BV}_{\text{eff}}$  and  $\mathbf{IBV}_{\text{eff}}$  are chosen to satisfy the following constraints:

1. Continuity of  $I_D$  between reverse bias and reverse breakdown regions (i.e., continuity of  $I_D$  at  $V_{di} = -\mathbf{BV}_{\text{eff}}$ ):

$$\mathbf{IBV}_{\text{eff}} = \mathbf{IRF} \cdot \mathbf{IS} \left( 1 - \left(\frac{3.0 \cdot \mathbf{NV}_{th}}{e \cdot \mathbf{BV}_{\text{eff}}}\right)^3 \right)$$

2. “Knee-on” voltage/current matching:

$$\mathbf{IBV}_{\text{eff}} \cdot \exp\left(-\frac{\mathbf{BV}_{\text{eff}} - \mathbf{BV}}{\mathbf{NV}_{th}}\right) = \mathbf{IBV}$$

Substituting the first expression into the second yields a single constraint on  $\mathbf{BV}_{\text{eff}}$  which cannot be solved for directly. By performing some basic algebraic manipulation and rearranging terms, the problem of finding  $\mathbf{BV}_{\text{eff}}$  which satisfies the above two constraints can be cast as finding the (unique) solution of the equation

$$\mathbf{BV}_{\text{eff}} = f(\mathbf{BV}_{\text{eff}}), \tag{2.1}$$

where  $f(\cdot)$  is the function that is obtained by solving for the  $BV_{\text{eff}}$  term which appears in the exponential in terms of  $BV_{\text{eff}}$  and the other parameters. **Xyce** solves Eqn. 2.1 by performing the so-called *Picard Iteration* procedure [5], i.e. by producing successive estimates of  $BV_{\text{eff}}$  (which we will denote as  $BV_{\text{eff}}^k$ ) according to

$$BV_{\text{eff}}^{k+1} = f(BV_{\text{eff}}^k)$$

starting with an initial guess of  $BV_{\text{eff}}^0 = BV$ . The current iteration procedure implemented in **Xyce** can be shown to guarantee at least six significant digits of accuracy between the numerical estimate of  $BV_{\text{eff}}$  and the true value.

In addition to the above, **Xyce** also requires that  $BV_{\text{eff}}$  lie in the range  $BV \geq BV_{\text{eff}} \geq 3.0NV_{th}$ . In terms of  $IBV$ , this is equivalent to enforcing the following two constraints:

$$IRF \cdot IS \left( 1 - \left( \frac{3.0 \cdot NV_{th}}{e \cdot BV} \right)^3 \right) \leq IBV \quad (2.2)$$

$$IRF \cdot IS (1 - e^{-3}) \exp \left( \frac{-3.0 \cdot NV_{th} + BV}{NV_{th}} \right) \geq IBV \quad (2.3)$$

**Xyce** first checks the value of  $IBV$  to ensure that the above two constraints are satisfied. If Eqn. 2.2 is violated, **Xyce** sets  $IBV_{\text{eff}}$  to be equal to the left-hand side of Eqn. 2.2 and, correspondingly, sets  $BV_{\text{eff}}$  to  $-3.0 \cdot NV_{th}$ . If Eqn. 2.3 is violated, **Xyce** sets  $IBV_{\text{eff}}$  to be equal to the left-hand side of Eqn. 2.3 and, correspondingly, sets  $BV_{\text{eff}}$  to  $BV$ .

### Capacitance (Level=1)

The p-n diode capacitance consists of a depletion layer capacitance  $C_d$  and a diffusion capacitance  $C_{dif}$ . The first is given by

$$C_d = \begin{cases} CJ \cdot AREA \left( 1 - \frac{V_{di}}{VJ} \right)^{-M}, & V_{di} \leq FC \cdot VJ \\ \frac{CJ \cdot AREA}{F2} \left( F3 + M \frac{V_{di}}{VJ} \right), & V_{di} > FC \cdot VJ \end{cases}$$

The diffusion capacitance (sometimes referred to as the transit time capacitance) is

$$C_{dif} = TTG_d = TT \frac{dI_D}{dV_{di}}$$

where  $G_d$  is the junction conductance.

### Temperature Effects (Level=1)

The diode model contains explicit temperature dependencies in the ideal diode current, the generation/recombination current and the breakdown current. Further temperature

dependencies are present in the diode model via the saturation current  $I_S$ , the depletion layer junction capacitance  $CJ$ , the junction potential  $V_J$ .

$$\begin{aligned}
 V_t(T) &= \frac{kT}{q} \\
 V_{tnom}(T) &= \frac{k\mathbf{TNOM}}{q} \\
 E_g(T) &= E_{g0} - \frac{\alpha T^2}{\beta + T} \\
 E_{gNOM}(T) &= E_{g0} - \frac{\alpha \mathbf{TNOM}^2}{\mathbf{TNOM} + \beta} \\
 arg1(T) &= -\frac{E_g(T)}{2kT} + \frac{E_{g300}}{2kT_0} \\
 arg2(T) &= -\frac{E_{gNOM}(T)}{2k\mathbf{TNOM}} + \frac{E_{g300}}{2kT_0} \\
 pbfact1(T) &= -2.0 \cdot V_t(T) \left( 1.5 \cdot \ln\left(\frac{T}{T_0}\right) + q \cdot arg1(T) \right) \\
 pbfact2(T) &= -2.0 \cdot V_{tnom}(T) \left( 1.5 \cdot \ln\left(\frac{\mathbf{TNOM}}{T_0}\right) + q \cdot arg2(T) \right) \\
 pbo(T) &= (\mathbf{VJ} - pbfact2(T)) \frac{T_0}{\mathbf{TNOM}} \\
 V_J(T) &= pbfact1(T) + \frac{T}{T_0} pbo(T) \\
 gma_{old}(T) &= \frac{\mathbf{VJ} - pbo(T)}{pbo(T)} \\
 gma_{new}(T) &= \frac{V_J(T) - pbo(T)}{pbo(T)} \\
 CJ(T) &= \mathbf{CJ0} \frac{1.0 + \mathbf{M} (4.0 \times 10^{-4} (T - T_0) - gma_{new}(T))}{1.0 + \mathbf{M} (4.0 \times 10^{-4} (\mathbf{TNOM} - T_0) - gma_{old}(T))} \\
 I_S(T) &= \mathbf{IS} \cdot \exp\left(\left(\frac{T}{\mathbf{TNOM}} - 1.0\right) \cdot \frac{\mathbf{EG}}{\mathbf{NV}_t(T)} + \frac{\mathbf{XTI}}{\mathbf{N}} \cdot \ln\left(\frac{T}{\mathbf{TNOM}}\right)\right)
 \end{aligned}$$

where, for silicon,  $\alpha = 7.02 \times 10^{-4} \text{ eV/K}$ ,  $\beta = 1108 \text{ }^\circ\text{K}$  and  $E_{g0} = 1.16 \text{ eV}$ .

For a more thorough description of p-n junction physics, see [9]. For a thorough description of the U.C. Berkeley SPICE models see Reference [11].

## Independent Current Source

|                               |  |
|-------------------------------|--|
| <b>General Form</b>           | <code>I&lt;name&gt; &lt;(+) node&gt; &lt;(-) node&gt; + [ [DC] &lt;value&gt; ]</code><br>+ [transient specification]   |
| <b>Examples</b>               | <code>ISLOW 1 22 SIN(0.5 1.0ma 1KHz 1ms)</code><br><code>IPULSE 1 3 PULSE(-1 1 2ns 2ns 2ns 50ns 100ns)</code>  |
| <b>Symbol</b>                 |   |
| <b>Description</b>            | Positive current flows from the positive node through the source to the negative node. Both constant DC values and time-dependent values for the source can be specified. One or both of the DC and transient values may be specified.<br>[transient specification]  |
| <b>Parameters and Options</b> | There are five predefined time-varying functions for sources: <ul style="list-style-type: none"> <li>■ <code>PULSE(&lt;parameters&gt;)</code> - pulse waveform</li> <li>■ <code>SIN(&lt;parameters&gt;)</code> - sinusoidal waveform</li> <li>■ <code>EXP(&lt;parameters&gt;)</code> - exponential waveform</li> <li>■ <code>PWL(&lt;parameters&gt;)</code> - piecewise linear waveform</li> <li>■ <code>SFFM(&lt;parameters&gt;)</code> - frequency-modulated waveform</li> </ul> |

### Transient Specifications

This section outlines the available transient specifications.  $\Delta t$  and  $T_F$  are the time step size and simulation end-time, respectively.

#### Pulse

`PULSE(I1 I2 TD TR TF PW PER)`

| Parameter          | Default    | Unit |
|--------------------|------------|------|
| I1 (Initial Value) | N/A        | amp  |
| I2 (Pulse Value)   | N/A        | amp  |
| TD (Delay Time)    | 0.0        | s    |
| TR (Rise Time)     | $\Delta t$ | s    |
| TF (Fall Time)     | $\Delta t$ | s    |
| PW (Pulse Width)   | $T_F$      | s    |
| PER (Period)       | $T_F$      | s    |

Sine

SIN(I0 IA FREQ TD THETA)

| Parameter                  | Default    | Unit |
|----------------------------|------------|------|
| I0 (Offset)                | N/A        | amp  |
| IA (Amplitude)             | N/A        | amp  |
| FREQ (Frequency)           | 0.0        | s    |
| TD (Delay)                 | $\Delta t$ | s    |
| THETA (Attenuation Factor) | $\Delta t$ | s    |

The waveform is shaped according to the following equations:

$$I = \begin{cases} I_0, & 0 < t < T_D \\ I_0 + I_A \sin[2\pi \cdot \mathbf{FREQ} \cdot (t - T_D)] \exp[-(t - T_D) \cdot \mathbf{THETA}], & T_D < t < T_F \end{cases}$$

Exponent

EXP(I1 I2 TD1 TAU1 TD2 TAU2)



| Parameter                 | Default          | Unit |
|---------------------------|------------------|------|
| I1 (Initial Phase)        | N/A              | amp  |
| IA (Amplitude)            | N/A              | amp  |
| TD1 (Rise Delay Time)     | 0.0              | s    |
| TAU1 (Rise Time Constant) | $\Delta t$       | s    |
| TD2 (Delay Fall Time)     | $TD1 + \Delta t$ | s    |
| TAU2 (Fall Time Constant) | $\Delta t$       | s    |

The waveform is shaped according to the following equations:

$$I = \begin{cases} I_1, & 0 < t < TD1 \\ I_1 + (I_2 - I_1)\{1 - \exp[-(t - TD1)/TAU1]\}, & TD1 < t < TD2 \\ I_1 + (I_2 - I_1)\{1 - \exp[-(t - TD1)/TAU1]\} \\ \quad + (I_1 - I_2)\{1 - \exp[-(t - TD2)/TAU2]\}, & TD2 < t < T_2 \end{cases}$$

### Piecewise Linear

PWL <t0> <i0> [<tn> <in>]\*

PWL FILE "<name>"

| Parameter                   | Default                    | Unit |
|-----------------------------|----------------------------|------|
| <tn> (Time at Corner)       | s                          | none |
| <in> (Current at Corner)    | amp                        | none |
| <n> (Number of Repetitions) | positive integer, 0, or -1 | none |

When the FILE option is given, **Xyce** will read the corner points from the file specified in the <name> field. This file should be a plain ASCII text file with time/current pairs. There should be one pair per line, and the time and current values should be separated by whitespace or commas.

### Frequency Modulated

SFFM (<ioff> <iAMPL> <fc> <mod> <fm>)

| Parameter                                     | Default | Unit    |
|---|---------|---------|
| <i <sub>off</sub> > (Offset Current)          | amp     | none    |
| <i <sub>amp1</sub> > (Peak Current Amplitude) | amp     | none    |
| <f <sub>c</sub> > (Carrier Frequency)         | hertz   | 1/TSTOP |
| <mod> (Modulation Index)                      |         | 0       |
| <f <sub>m</sub> > (Modulation Frequency)      | hertz   | 1/TSTOP |

The waveform is shaped according to the following equations:

$$V = \mathbf{i\text{off}} + \mathbf{i\text{amp1}} \cdot \sin(2\pi \cdot \mathbf{f\text{c}} \cdot \mathbf{TIME} + \mathbf{mod} \cdot \sin(2\pi \cdot \mathbf{f\text{m}} \cdot \mathbf{TIME}))$$

where **TIME** is the current simulation time.

## Independent Voltage Source

The syntax of this device is exactly the same as for an Independent Current Source. For an Independent Voltage Source, substitute an I for the V on the instance line. The V device generates a voltage, whereas the I device generates a current. For details about the Independent Current Source, see section 2.2.

|                                      |   |
|--------------------------------------|---|
| <b><u>General Form</u></b>           | V<name> <(+) node> <(-) node> + [ [DC] <value> ]<br>+ [transient specification]   |
| <b><u>Examples</u></b>               | VSLOW 1 22 SIN(0.5 1.0ma 1kHz 1ms)<br>VPULSE 1 3 PULSE(-1 1 2ns 2ns 2ns 50ns 100ns)   |
| <b><u>Symbol</u></b>                 |    |
| <b><u>Description</u></b>            | Positive current flows from the positive node through the source to the negative node. Both constant DC values and time-dependent values for the source can be specified. One or both of the DC and transient values may be specified.<br>[transient specification]   |
| <b><u>Parameters and Options</u></b> | There are five predefined time-varying functions for sources: <ul style="list-style-type: none"> <li>■ PULSE(&lt;parameters&gt;) - pulse waveform</li> <li>■ SIN(&lt;parameters&gt;) - sinusoidal waveform</li> <li>■ EXP(&lt;parameters&gt;) - exponential waveform</li> <li>■ PWL(&lt;parameters&gt;) - piecewise linear waveform</li> <li>■ SFFM(&lt;parameters&gt;) - frequency-modulated waveform</li> </ul> |

## Voltage Controlled Voltage Source

|                               |  |
|-------------------------------|--|
| <b>General Form</b>           | <pre>E&lt;name&gt; &lt;(+) node&gt; &lt;(-) node&gt; &lt;(+) controlling node&gt; + &lt;(-) controlling node&gt; &lt;gain&gt; E&lt;name&gt; &lt;(+) &lt;node&gt; &lt;(-) node&gt; VALUE = { &lt;expression&gt; } E&lt;name&gt; &lt;(+) &lt;node&gt; &lt;(-) node&gt; TABLE { &lt;expression&gt; } = + &lt; &lt;input value&gt;,&lt;output value&gt; &gt;*</pre>  |
| <b>Examples</b>               | <pre>EBUFFER 1 2 10 11 5.0 ESQROOT 5 0 VALUE = {5V*SQRT(V(3,2))} ET2 2 0 TABLE {V(ANODE,CATHODE)} = (0,0) (30,1)</pre>   |
| <b>Symbol</b>                 |   |
| <b>Description</b>            | <p>In the first form, a specified voltage drop elsewhere in the circuit controls the voltage-source output. The second and third forms using the VALUE and TABLE keywords, respectively, are used in analog behavioral modeling. These two forms are automatically converted within <b>Xyce</b> to its principal ABM device, the B nonlinear dependent source device. See the <b>Xyce</b> User's Guide for more information on analog behavioral modeling.</p> |
| <b>Parameters and Options</b> | <p>(+) and (-) nodes</p> <p>Output nodes. Positive current flows from the (+) node through the source to the (-) node.</p> <p>&lt;(+) controlling node&gt; and &lt;(-) controlling node&gt;</p> <p>Node pairs that define a set of controlling voltages. A given node may appear multiple times and the output and controlling nodes may be the same.</p>  |

## Current Controlled Current Source

|                               |   |
|-------------------------------|---|
| <b>General Form</b>           | <pre>F&lt;name&gt; &lt;(+) node&gt; &lt;(-) node&gt; + &lt;controlling V device name&gt; &lt;gain&gt; F&lt;name&gt; &lt;(+) node&gt; &lt;(-) node&gt; POLY(&lt;value&gt;) + &lt;controlling V device name&gt;* + &lt;polynomial coefficient value&gt; &gt;*</pre>   |
| <b>Examples</b>               | <pre>FSENSE 1 2 VSENSE 10.0 FAMP 13 0 POLY(1) VIN 0 500 FNONLIN 100 101 POLY(2) VCNTRL1 VCINTRL2 0.0 13.6 0.2 0.005</pre>   |
| <b>Symbol</b>                 |    |
| <b>Description</b>            | <p>In the first form, a specified current elsewhere in the circuit controls the current-source output. The second form using the POLY keyword is used in analog behavioral modeling. This form is automatically converted within <b>Xyce</b> to its principal ABM device, the B nonlinear dependent source device. See the <b>Xyce</b> User's Guide for more information on analog behavioral modeling.</p> |
| <b>Parameters and Options</b> | <p>(+) and (-) nodes<br/>Output nodes. Positive current flows from the (+) node through the source to the (-) node.</p> <p>&lt;controlling V device name&gt;<br/>The controlling voltage source which must be an independent voltage source (V device).</p>   |

## Current Controlled Voltage Source

The syntax of this device is exactly the same as for a Current Controlled Current Source. For a Current-Controlled Voltage Source just substitute an H for the F. The H device generates a voltage, whereas the F device generates a current.

---

|                     |  |
|---------------------|--|
|                     | H<name> <(+) node> <(-) node><br>+ <controlling V device name> <gain>  |
| <b>General Form</b> | H<name> <(+) node> <(-) node> POLY(<value>)<br>+ <controlling V device name>*<br>+ < <polynomial coefficient value> >* |
| <b>Examples</b>     | HSENSE 1 2 VSENSE 10.0<br>HAMP 13 0 POLY(1) VIN 0 500<br>HNONLIN 100 101 POLY(2) VCNTRL1 VCINTRL2 0.0 13.6 0.2 0.005   |
| <b>Symbol</b>       |                                       |

---

## Voltage Controlled Current Source

|                               |  |
|-------------------------------|--|
| <b>General Form</b>           | <pre>G&lt;name&gt; &lt;(+) node&gt; &lt;(-) node&gt; &lt;(+) controlling node&gt; + &lt;(-) controlling node&gt; &lt;transconductance&gt; G&lt;name&gt; &lt;(+) &lt;node&gt; &lt;(-) node&gt; VALUE = { &lt;expression&gt; } G&lt;name&gt; &lt;(+) &lt;node&gt; &lt;(-) node&gt; TABLE { &lt;expression&gt; } = + &lt; &lt;input value&gt;, &lt;output value&gt; &gt;*</pre>   |
| <b>Examples</b>               | <pre>GBUFFER 1 2 10 11 5.0 GPSK 11 6 VALUE = {5MA*SIN(6.28*10kHz*TIME+V(3))} GA2 2 0 TABLE {V(5)} = (0,0) (1,5) (10,5) (11,0)</pre>  |
| <b>Symbol</b>                 |   |
| <b>Description</b>            | <p>In the first form, a specified voltage drop elsewhere in the circuit controls the current-source output. The second and third forms using the VALUE and TABLE keywords, respectively, are used in analog behavioral modeling. These two forms are automatically converted within <b>Xyce</b> to its principal ABM device, the B nonlinear dependent source device. See the <b>Xyce</b> User's Guide for more information on analog behavioral modeling.</p> |
| <b>Parameters and Options</b> | <p>(+) and (-) nodes</p> <p>Output nodes. Positive current flows from the (+) node through the source to the (-) node.</p> <p>&lt;(+) controlling node&gt; and &lt;(-) controlling node&gt;</p> <p>Node pairs that define a set of controlling voltages. A given node may appear multiple times and the output and controlling nodes may be the same.</p>  |

## Nonlinear Dependent Source

|                     |  |
|---------------------|--|
| <b>General Form</b> | B<name> <(+) node> <(-) node> V={ABM expression}<br>B<name> <(+) node> <(-) node> I={ABM expression}   |
| <b>Examples</b>     | B1 2 0 V={sqrt(V(1))}<br>B2 4 0 V={V(1)*TIME}<br>B3 4 2 I={I(V1) + V(4,2)/100}<br>B4 5 0 V={Table {V(5)}=(0,0) (1.0,2.0) (2.0,3.0) (3.0,10.0)}   |
| <b>Description</b>  | The nonlinear dependent source device, also known as the B-source device, is used in analog behavioral modeling (ABM). The (+) and (-) nodes are the output nodes. Positive current flows from the (+) node through the source to the (-) node.  |
| <b>Comments</b>     | See the “Analog Behavioral Modeling” chapter of the <b>Xyce</b> User’s Guide for more information on the Bsource device and ABM expressions, and the “Parameters and Expressions” section of the User’s Guide for more information on expressions in general.<br><b>Note: the braces surrounding all expressions are required.</b> |

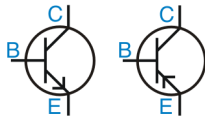

## Bipolar Junction Transistor (BJT)

|                               |  |
|-------------------------------|--|
| <b>General Form</b>           | Q<name> < collector node> <base node> <emitter node><br>+ [substrate node] <model name> [area value]   |
| <b>Examples</b>               | Q2 10 2 9 PNP1<br>Q12 14 2 0 1 NPN2 2.0<br>Q6 VC 4 11 [SUB] LAXPNP   |
| <b>Symbols</b>                |   |
| <b>Model Form</b>             | .MODEL <model name> NPN [model parameters]<br>.MODEL <model name> PNP [model parameters]<br>.MODEL <model name> VBIC [model parameters]  |
| <b>Parameters and Options</b> | [substrate node]<br><br>Optional and defaults to ground. Since <b>Xyce</b> permits alphanumeric node names and because there is no easy way to make a distinction between these and the model names, the name (not a number) used for the substrate node must be enclosed in square brackets [ ]. Otherwise, nodes would be interpreted as model names. See the fourth example above.<br><br>[area value]<br><br>The relative device area with a default value of 1. |

**Comments**

The BJT is modeled as an intrinsic transistor using ohmic resistances in series with the collector ( $R_C/\text{area}$ ), with the base (value varies with current, see BJT equations) and with the emitter ( $R_E/\text{area}$ ). For model parameters with optional names, such as VAF and VA (the optional name is in parentheses), either may be used. For model types NPN and PNP, the isolation junction capacitance is connected between the intrinsic-collector and substrate nodes. This is the same as in SPICE and works well for vertical IC transistor structures.

The third model card in the **Model Form** section above is a deprecated form that was required for Release 5.1 of **Xyce**, and selected the NPN VBIC model. The VBIC model in Release 5.2 fully supports both PNP and NPN transistors, and so NPN and PNP model cards are now the preferred way to specify VBIC models. The VBIC model card will be dropped in a future release of **Xyce**.

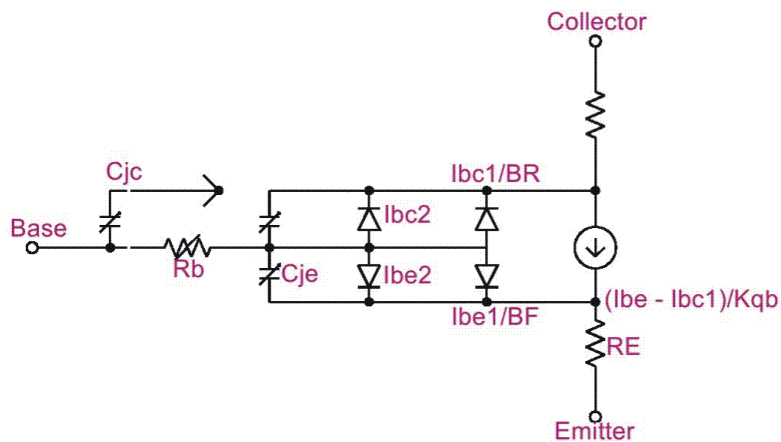

**Figure 2.1.** BJT model schematic. Adapted from reference [2].

### BJT Level selection

**Xyce** supports the level 1 BJT model, which is based on the documented standard SPICE 3F5 BJT model, but was coded independently at Sandia. It is mostly based on the classic Gummel-Poon BJT model [6].

Beginning with **Xyce** Release 5.1, a version of the VBIC model is provided as BJT level

10. This is the 3-terminal, electrothermal, constant phase model of VBIC version 1.2 [7]. The **Xyce** implementation of this model is provided for experimental use and should be considered a beta release. As of version 5.1.2 of **Xyce**, this model contains voltage limiting convergence enhancements, and so is much more stable than in previous releases.

As of release 5.2 of **Xyce**, the VBIC model supports both PNP and NPN transistors, and may therefore be used with model cards of type PNP and NPN. In prior releases, it was necessary to use the model type VBIC to emphasize the absence of PNP support. The VBIC model card required by the prior release is still supported, but is now deprecated in favor of the normal BJT model types.

### BJT Operating Temperature

Model parameters may be assigned unique measurement temperatures using the TNOM model parameter. See BJT model parameters for more information.

### Level=1 Model Parameters

Table 2.20 gives the available model parameters for the level 1 BJT.

| Model parameters | Description                                   | Units | Default |
|------------------|---|-------|---------|
| BF               | Ideal Maximum Forward Beta                    |       | 100.0   |
| BR               | Ideal Maximum Reverse Beta                    |       | 1.0     |
| CJC              | Base-collector Zero-bias p-n Capacitance      | farad | 0.0     |
| CJE              | Base-emitter Zero-bias p-n Capacitance        | farad | 0.0     |
| CJS              | Substrate Zero-bias p-n Capacitance           | farad | 0.0     |
| EG               | Bandgap Voltage (Barrier Height)              | eV    | 1.11    |
| FC               | Forward-bias Depletion Capacitor Coefficient  |       | 0.5     |
| IKF              | Corner for Forward-beta High-current Roll-off | amp   | 1E99    |
| IKR              | Corner for Reverse-beta High-current Roll-off | amp   | 1E99    |
| IRB              | Current at which Rb Falls off by half         | amp   | 0.0     |
| IS               | Transport Saturation Current                  | amp   | 1E-16   |
| ISC              | Base-collector Leakage Saturation Current     | amp   | 0.0     |
| ISE              | Base-emitter Leakage Saturation Current       | amp   | 0.0     |

| Model parameters | Description   | Units  | Default |
|------------------|---|--------|---------|
| ITF              | Transit Time Dependency on Ic                                     | amp    | 0.0     |
| KF               | Flicker Noise Coefficient   |        | 0.0     |
| MJC              | Base-collector p-n Grading Factor                                 |        | 0.33    |
| MJE              | Base-emitter p-n Grading Factor                                   |        | 0.33    |
| MJS              | Substrate p-n Grading Factor                                      |        | 0.0     |
| NC               | Base-collector Leakage Emission Coefficient                       |        | 2.0     |
| NE               | Base-emitter Leakage Emission Coefficient                         |        | 1.5     |
| NF               | Forward Current Emission Coefficient                              |        | 1.0     |
| NK               | High Current Rolloff Coefficient                                  |        | 0.5     |
| NR               | Reverse Current Emission Coefficient                              |        | 1.0     |
| PTF              | Excess Phase @ $1/(2\pi \cdot TF)$ Hz                             | degree | 0.0     |
| RB               | Zero-bias (Maximum) Base Resistance                               | ohm    | 0.0     |
| RBM              | Minimum Base Resistance   | ohm    | 0.0     |
| RC               | Collector Ohmic Resistance  | ohm    | 0.0     |
| RE               | Emitter Ohmic Resistance  | ohm    | 0.0     |
| TEMPMODEL        | Specification to type of parameter interpolation over temperature | string |         |
| TF               | Ideal Forward Transit Time  | sec    | 0.0     |
| TR               | Ideal Reverse Transit Time  | sec    | 0.0     |
| TNOM             | Parameter Measurement Temperature                                 | °C     | 27.0    |
| VAF              | Forward Early Voltage   | volt   | 1E99    |
| VAR              | Reverse Early Voltage   | volt   | 1E99    |
| VJC              | Base-collector Built-in Potential                                 | volt   | 0.75    |
| VJE              | Base-emitter Built-in Potential                                   | volt   | 0.75    |
| VJS              | Substrate Built-in Potential                                      | volt   | 0.75    |
| VTF              | Transit Time Dependency on $V_{bc}$                               | volt   | 1E99    |
| XCJC             | Fraction of <b>CJC</b> Connected Internally to <b>RB</b>          |        | 1.0     |
| XTB              | Forward and Reverse Beta Temperature Coefficient                  |        | 0.0     |
| XTF              | Transit Time Bias Dependence Coefficient                          |        | 0.0     |

| Model parameters | Description | Units | Default |
|------------------|-------------|-------|---------|
|------------------|-------------|-------|---------|

Table 2.20: BJT Model Parameters.

### Level=10 model parameters

Table 2.21 gives the available model parameters for the level 10 BJT.

¿

| Parameter | Description   | Units           | Default |
|-----------|---|-----------------|---------|
| AFN       | Base-Emitter Flicker Noise coefficient (unused)         | –               | 1       |
| AJC       | Base-Collector capacitor smoothing factor               | –               | -0.5    |
| AJE       | Base-Emitter capacitor smoothing factor                 | –               | -0.5    |
| AJS       | Substrate-collector capacitor smoothing factor (unused) | –               | -0.5    |
| ART       |   | –               | 0.1     |
| AVC1      | B-C weak avalanche parameter                            | V <sup>-1</sup> | 0       |
| AVC2      | B-C weak avalanche parameter                            | V <sup>-1</sup> | 0       |
| BFN       | B-E flicker noise dependence (unused)                   | –               | 1       |
| CBC0      | Extrinsic B-C overlap capacitance                       | F               | 0       |
| CBE0      | Extrinsic B-E overlap capacitance                       | F               | 0       |
| CCS0      | (unused)  | –               | 0       |
| CJC       | B-C zero-bias capacitance                               | F               | 0       |
| CJCP      | S-C zero-bias capacitance                               | F               | 0       |
| CJE       | B-E zero-bias capacitance                               | F               | 0       |
| CJEP      | S-E zero-bias capacitance                               | F               | 0       |
| CTH       | Thermal capacitance                                     | F               | 0       |
| DEAR      | Activation energy for ISRR                              | –               | 0       |
| DTEMP     | Device temperature (use 0.0 for ambient)                | –               | 0       |
| EA        | Activation energy for IS                                | eV              | 1.12    |
| EAIC      | Activation energy for IBCI                              | eV              | 1.12    |
| EAIE      | Activation energy for IBEL                              | eV              | 1.12    |
| EAIS      | Activation energy for IBCIP                             | eV              | 1.12    |
| EANC      | Activation energy for IBCN                              | eV              | 1.12    |

| Parameter | Description                                  | Units | Default |
|-----------|--|-------|---------|
| EANE      | Activation energy for IBEN                   | eV    | 1.12    |
| EANS      | Activation energy for IBCNP                  | eV    | 1.12    |
| EAP       | Activation energy for ISP                    | –     | 1.12    |
| EBBE      | (unused)                                     | –     | 0       |
| FC        | Forward-bias depletion capacitance limit     | –     | 0.9     |
| GAMM      | Epi doping parameter                         | –     | 0       |
| HRCF      | High current RC factor                       | –     | 0       |
| IBBE      |  | –     | 1e-06   |
| IBCI      | Ideal B-C saturation current                 | A     | 1e-16   |
| IBCIP     | Ideal parasitic B-C saturation current       | A     | 0       |
| IBCN      | Nonideal B-C saturation current              | A     | 0       |
| IBCNP     | Nonideal parasitic B-C saturation current    | A     | 0       |
| IBEI      | Ideal B-E saturation current                 | A     | 1e-18   |
| IBEIP     | Ideal parasitic B-E saturation current       | A     | 0       |
| IBEN      | Nonideal B-E saturation current              | A     | 0       |
| IBENP     | Nonideal parasitic B-E saturation current    | A     | 0       |
| IKF       | Forward knee current                         | A     | 0       |
| IKP       | Parasitic knee current                       | A     | 0       |
| IKR       | Reverse knee current                         | A     | 0       |
| IS        | Transport saturation current                 | A     | 1e-16   |
| ISP       | Parasitic transport saturation current       | A     | 0       |
| ISRR      | Saturation current for reverse operation     | –     | 1       |
| ITF       | Coefficient of $t_f$ dependence on $I_c$     | –     | 0       |
| KFN       | B-E flicker (1/f) noise coefficient (unused) | –     | 0       |
| MC        | B-C grading coefficient                      | –     | 0.33    |
| ME        | B-E grading coefficient                      | –     | 0.33    |
| MS        | S-C grading coefficient                      | –     | 0.33    |
| NBBE      |  | –     | 1       |
| NCI       | Ideal B-C emission coefficient               | –     | 1       |
| NCIP      | Ideal parasitic B-C emission coefficient     | –     | 1       |

| Parameter | Description  | Units              | Default |
|-----------|--|--------------------|---------|
| NCN       | Non-ideal B-C emission coefficient                       | –                  | 2       |
| NCNP      | Non-ideal parasitic B-C emission coefficient             | –                  | 2       |
| NEI       | Ideal B-E emission coefficient                           | –                  | 1       |
| NEN       | Non-ideal B-E emission coefficient                       | –                  | 2       |
| NF        | Forward emission coefficient                             | –                  | 1       |
| NFP       | Parasitic forward emission coefficient                   | –                  | 1       |
| NKF       |  | –                  | 0.5     |
| NR        | Reverse emission coefficient                             | –                  | 1       |
| PC        | B-C built-in potential                                   | –                  | 0.75    |
| PE        | B-E built-in potential                                   | –                  | 0.75    |
| PS        | S-C built-in potential                                   | –                  | 0.75    |
| QBM       |  | –                  | 0       |
| QCO       | Epi charge parameter                                     | C                  | 0       |
| QTF       | Variation of $t_f$ with base width modulation            | –                  | 0       |
| RBI       | Intrinsic base resistance                                | $\Omega$           | 0       |
| RBP       | Parasitic base resistance                                | $\Omega$           | 0       |
| RBX       | Extrinsic base resistance                                | $\Omega$           | 0       |
| RCI       | Intrinsic Collector resistance                           | $\Omega$           | 0       |
| RCX       | Extrinsic Collector resistance                           | $\Omega$           | 0       |
| RE        | Emitter resistance                                       | $\Omega$           | 0       |
| RS        | Substrate resistance                                     | $\Omega$           | 0       |
| RTH       | Thermal resistance, must be given for self-heating       | $\Omega$           | 0       |
| TAVC      | Temperature coefficient of $A_{vc2}$                     | –                  | 0       |
| TD        | Forward excess-phase delay time (unused in this version) | –                  | 0       |
| TF        | Forward transit time                                     | s                  | 0       |
| TNBBE     |  | –                  | 0       |
| TNF       | Temperature coefficient of $N_f$                         | –                  | 0       |
| TNOM      | Nominal temperature                                      | $^{\circ}\text{C}$ | 27      |
| TR        | Reverse transit time                                     | –                  | 0       |

| Parameter | Description   | Units | Default |
|-----------|---|-------|---------|
| TVBBE1    |   | –     | 0       |
| TVBBE2    |   | –     | 0       |
| VBBE      |   | –     | 0       |
| VEF       | Forward Early voltage   | V     | 0       |
| VER       | Reverse Early voltage   | V     | 0       |
| VERS      | Version of this VBIC model  | –     | 1.2     |
| VO        | Epi drift saturation voltage  | V     | 0       |
| VREV      |   | –     | 0       |
| VRT       |   | –     | 0       |
| VTF       | Coefficient of $t_f$ dependence on $V_{bc}$                                 | –     | 0       |
| WBE       | Portion of $I_{bei}$ from $V_{bei}$   | –     | 1       |
| WSP       | Portion of $I_{ccp}$ from $V_{bep}$   | –     | 1       |
| XII       | Temperature exponent of $I_{bei}$ , $I_{bci}$ , $I_{beip}$ , and $I_{bcip}$ | –     | 3       |
| XIKF      |   | –     | 0       |
| XIN       | Temperature exponent of $I_{ben}$ , $I_{bcn}$ , $I_{benp}$ , and $I_{bcnp}$ | –     | 3       |
| XIS       | Temperature exponent of $I_S$   | –     | 3       |
| XISR      | Temperature exponent of $I_{SRR}$   | –     | 0       |
| XRBI      |   | –     | 0       |
| XRBP      |   | –     | 0       |
| XRBX      |   | –     | 0       |
| XRCI      |   | –     | 0       |
| XRCX      |   | –     | 0       |
| XRE       | Temperature exponent of $r_e$   | –     | 0       |
| XRS       | Temperature exponent of $r_s$   | –     | 0       |
| XTF       | Coefficient of $t_f$ with bias dependence                                   | –     | 0       |
| XVO       | Temperature exponent of $v_o$   | –     | 0       |

Table 2.21: VBIC Device Model Parameters.



## BJT Equations

The BJT implementation within **Xyce** is based on [1]. The equations in this section describe an NPN transistor. For the PNP device, reverse the signs of all voltages and currents. The equations use the following variables:

|          |   |  |
|----------|---|--|
| $V_{be}$ | = | intrinsic base-intrinsic emitter voltage   |
| $V_{bc}$ | = | intrinsic base-intrinsic collector voltage   |
| $V_{bs}$ | = | intrinsic base-substrate voltage   |
| $V_{bw}$ | = | intrinsic base-extrinsic collector voltage (quasi-saturation only)                           |
| $V_{bx}$ | = | extrinsic base-intrinsic collector voltage   |
| $V_{ce}$ | = | intrinsic collector-intrinsic emitter voltage  |
| $V_{js}$ | = | (NPN) intrinsic collector-substrate voltage<br>= (PNP) intrinsic substrate-collector voltage |
| $V_t$    | = | $kT/q$ (thermal voltage)   |
| $V_{th}$ | = | threshold voltage  |
| $k$      | = | Boltzmann's constant   |
| $q$      | = | electron charge  |
| $T$      | = | analysis temperature (K)   |
| $T_0$    | = | nominal temperature (set using TNOM option)  |

Other variables are listed above in BJT Model Parameters.

### DC Current

The BJT model is based on the Gummel and Poon model [8] where the different terminal currents are written

$$\begin{aligned}
 I_e &= -I_{cc} - I_{be} + I_{re} + (C_{dife} + C_{de}) \frac{dV_{be}}{dt} \\
 I_c &= -I_{cc} + I_{bc} - I_{rc} - (C_{difc} + C_{dc}) \frac{dV_{bc}}{dt} \\
 I_b &= I_e - I_c
 \end{aligned}$$

Here,  $C_{dife}$  and  $C_{difc}$  are the capacitances related to the hole charges per unit area in the base,  $Q_{dife}$  and  $Q_{difc}$ , affiliated with the electrons introduced across the emitter-base and collector-base junctions, respectively. Also,  $C_{be}$  and  $C_{bc}$  are the capacitances related to donations to the hole charge of the base,  $Q_{be}$  and  $Q_{bc}$ , affiliated with the differences in the depletion regions of the emitter-base and collector-base junctions, respectively. The

intermediate currents used are defined as

$$\begin{aligned} -I_{be} &= \frac{\mathbf{IS}}{\mathbf{BF}} \left[ \exp\left(\frac{V_{be}}{\mathbf{NF}V_{th}}\right) - 1 \right] \\ -I_{cc} &= \frac{Q_{bo}}{Q_b} \mathbf{IS} \left[ \exp\left(\frac{V_{be}}{\mathbf{NF}V_{th}}\right) - \exp\left(\frac{V_{bc}}{\mathbf{NF}V_{th}}\right) \right] \\ -I_{bc} &= \frac{\mathbf{IS}}{\mathbf{BR}} \left[ \exp\left(\frac{V_{bc}}{\mathbf{NR}V_{th}}\right) - 1 \right] \\ I_{re} &= \mathbf{ISE} \left[ \exp\left(\frac{V_{be}}{\mathbf{NE}V_{th}}\right) - 1 \right] \\ I_{rc} &= \mathbf{ISC} \left[ \exp\left(\frac{V_{bc}}{\mathbf{NC}V_{th}}\right) - 1 \right] \end{aligned}$$

where the last two terms are the generation/recombination currents related to the emitter and collector junctions, respectively. The charge  $Q_b$  is the majority carrier charge in the base at large injection levels and is a key difference in the Gummel-Poon model over the earlier Ebers-Moll model. The ratio  $Q_b/Q_{bo}$  (where  $Q_{bo}$  represents the zero-bias base charge, i.e. the value of  $Q_b$  when  $V_{be} = V_{bc} = 0$ ) as computed by Xyce is given by

$$\frac{Q_b}{Q_{bo}} = \frac{q_1}{2} \left( 1 + \sqrt{1 + 4q_2} \right)$$

where

$$\begin{aligned} q_1 &= \left( 1 - \frac{V_{be}}{\mathbf{VAR}} - \frac{V_{bc}}{\mathbf{VAF}} \right)^{-1} \\ q_2 &= \frac{\mathbf{IS}}{\mathbf{IKF}} \left[ \exp\left(\frac{V_{be}}{\mathbf{NF}V_{th}}\right) - 1 \right] + \frac{\mathbf{IS}}{\mathbf{IKR}} \left[ \exp\left(\frac{V_{bc}}{\mathbf{NR}V_{th}}\right) - 1 \right] \end{aligned}$$

### Capacitance Terms

The capacitances listed in the above DC  $I - V$  equations each consist of a depletion layer capacitance  $C_d$  and a diffusion capacitance  $C_{dif}$ . The first is given by

$$C_d = \begin{cases} \mathbf{CJ} \left( 1 - \frac{V_{di}}{\mathbf{VJ}} \right)^{-\mathbf{M}} & V_{di} \leq \mathbf{FC} \cdot \mathbf{VJ} \\ \mathbf{CJ} (1 - \mathbf{FC})^{-(1+\mathbf{M})} \left[ 1 - \mathbf{FC}(1 + \mathbf{M}) + \mathbf{M} \frac{V_{di}}{\mathbf{VJ}} \right] & V_{di} > \mathbf{FC} \cdot \mathbf{VJ} \end{cases}$$

where  $\mathbf{CJ} = \mathbf{CJE}$  for  $C_{de}$ , and where  $\mathbf{CJ} = \mathbf{CJC}$  for  $C_{dc}$ . The diffusion capacitance (sometimes referred to as the transit time capacitance) is

$$C_{dif} = \mathbf{TT}G_d = \mathbf{TT} \frac{dI}{dV_{di}}$$

where  $I$  is the diode DC current given,  $G_d$  is the corresponding junction conductance, and where  $\mathbf{TT} = \mathbf{TF}$  for  $C_{dife}$  and  $\mathbf{TT} = \mathbf{TR}$  for  $C_{difc}$ .

### Temperature Effects

Spice temperature effects are default, but all levels of the BJT have a more advanced temperature compensation available. By specifying `TEMPMODEL=QUADRATIC` in the netlist, parameters can be interpolated quadratically between measured values extracted from data. In the BJT, `IS` and `ISE` are interpolated logarithmically because they can change over an order of magnitude or more for temperature ranges of interest. See Section 5.3 of the User's Guide for more details on how to include quadratic temperature effects.

For further information on BJT models, see [8]. For a thorough description of the U.C. Berkeley SPICE models see Reference [9].

## Junction Field-Effect Transistor (JFET)

---

**General Form** J<name> <drain node> <gate node> <source node> <model name>  
+ [area value] [device parameters]

---

**Examples**

```
JIN 100 1 0 JFAST
J13 22 14 23 JNOM 2.0
J1 1 2 0 2N5114
```

---

**Symbols**



---

**Model Form**

```
.MODEL <model name> NJF [model parameters]
.MODEL <model name> PJF [model parameters]
```

---

<drain node>

Node connected to drain.

<gate node>

Node connected to gate.

<source node>

Node connected to source.

<source node>

**Parameters and Options**

Name of model defined in .MODEL line.

[area value]

The JFET is modeled as an intrinsic FET using an ohmic resistance ( $R_D/\text{area}$ ) in series with the drain and another ohmic resistance ( $R_S/\text{area}$ ) in series with the source. area is an area factor with a default of 1.

[device parameters]

Parameters listed in Table 2.22 may be provided as space separated <parameter>=<value> specifications as needed. Any number of parameters may be specified.

---

**Comments**

The JFET was first proposed and analyzed by Shockley. The SPICE-compatible JFET model is an approximation to the Shockley analysis that employs an adjustable parameter B. Both the Shockley formulation and the SPICE approximation are available in Xyce.

**Device Parameters**

Table 2.22 gives the available device parameters for the JFET.

| Parameter | Description        | Units          | Default |
|-----------|--------------------|----------------|---------|
| AREA      | device area        | m <sup>2</sup> | 1       |
| TEMP      | Device temperature | °C             | 27      |

Table 2.22: JFET Device Parameters.

**Model Parameters**

Table 2.23 gives the available model parameters for the JFET.

| Parameter | Description  | Units            | Default |
|-----------|--|------------------|---------|
| AF        | Flicker noise exponent                             | –                | 1       |
| B         | Doping tail parameter (level 1)                    | V <sup>-1</sup>  | 1       |
| BETA      | Transconductance parameter                         | A/V <sup>2</sup> | 0.0001  |
| CGD       | Zero-bias gate-drain junction capacitance          | F                | 0       |
| CGS       | Zero-bias gate-source junction capacitance         | F                | 0       |
| DELTA     | Saturation voltage parameter (level 2)             | V                | 0       |
| FC        | Coefficient for forward-bias depletion capacitance | F                | 0.5     |
| IS        | Gate junction saturation current                   | A                | 1e-14   |
| KF        | Flicker noise coefficient                          | –                | 0.05    |
| LAMBDA    | Channel length modulation                          | V <sup>-1</sup>  | 0       |
| PB        | Gate junction potential                            | V                | 1       |
| RD        | Drain ohmic resistance                             | Ω                | 0       |

| Parameter | Description   | Units       | Default |
|-----------|---|-------------|---------|
| RS        | Source ohmic resistance   | $\Omega$    | 0       |
| TEMPMODEL | Specification to type of parameter interpolation over temperature (see User Guide section 5.3 | –           | NONE    |
| THETA     | Mobility modulation parameter (level 2)   | $V^{-1}$    | 0       |
| TNOM      | Nominal device temperature  | $^{\circ}C$ | 27      |
| VTO       | Threshold voltage   | V           | -2      |

Table 2.23: JFET Model Parameters.

### JFET Level selection

**Xyce** supports two JFET models. LEVEL=1, the default, is the SPICE 3f5 treatment. This model employs a doping profile parameter B. When B=1, the original SPICE square law is exactly implemented, and when B=0.6 the model is close to that of Shockley.

When LEVEL=2 is selected, the Shockley model is used with some additional physics effects: channel length modulation and the effect of gate electric field on mobility. An additional parameter, DELTA, is added to the LEVEL 2 model that allows the user to adjust the saturation voltage.

## Metal-Semiconductor FET (MESFET)

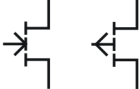
|                               |  |
|-------------------------------|--|
| <b>General Form</b>           | Z<name> < drain node> <gate node> <source node> <model name><br>+ [area value] [device parameters]   |
| <b>Examples</b>               | Z1 2 3 0 MESMOD AREA=1.4<br>Z1 7 2 3 ZM1   |
| <b>Symbols</b>                |   |
| <b>Model Form</b>             | .MODEL <model name> NMF [model parameters]<br>.MODEL <model name> PMF [model parameters]   |
|                               | <drain node><br>Node connected to drain.   |
|                               | <gate node><br>Node connected to gate.   |
|                               | <source node><br>Node connected to source.   |
| <b>Parameters and Options</b> | <source node><br>Name of model defined in .MODEL line.<br>[area value]<br>The MESFET is modeled as an intrinsic FET using an ohmic resistance ( $R_D/area$ ) in series with the drain and another ohmic resistance ( $R_S/area$ ) in series with the source. area is an area factor with a default of 1.<br>[device parameters]<br>Parameters listed in Table 2.24 may be provided as space separated <parameter>=<value> specifications as needed. Any number of parameters may be specified. |

**Comments**

Although MESFETs can be made of Si, such devices are not as common as GaAs MESFETS. And since the mobility of electrons is much higher than holes in GaAs, nearly all commercial devices are n-type MESFETS.

**Device Parameters**

Table 2.24 gives the available device parameters for the MESFET.

| Parameter | Description        | Units          | Default |
|-----------|--------------------|----------------|---------|
| AREA      | device area        | m <sup>2</sup> | 1       |
| TEMP      | Device temperature | °C             | 27      |

Table 2.24: MESFET Device Parameters.

**Model Parameters**

Table 2.25 gives the available model parameters for the MESFET.

| Parameter | Description  | Units            | Default |
|-----------|--|------------------|---------|
| AF        | Flicker noise exponent                             | –                | 1       |
| ALPHA     | Saturation voltage parameter                       | V <sup>-1</sup>  | 2       |
| B         | Doping tail parameter                              | V <sup>-1</sup>  | 0.3     |
| BETA      | Transconductance parameter                         | A/V <sup>2</sup> | 0.0025  |
| CGD       | Zero-bias gate-drain junction capacitance          | F                | 0       |
| CGS       | Zero-bias gate-source junction capacitance         | F                | 0       |
| FC        | Coefficient for forward-bias depletion capacitance | F                | 0.5     |
| IS        | Gate junction saturation current                   | A                | 1e-14   |
| KF        | Flicker noise coefficient                          | –                | 0.05    |
| LAMBDA    | Channel length modulation                          | V <sup>-1</sup>  | 0       |
| PB        | Gate junction potential                            | V                | 1       |
| RD        | Drain ohmic resistance                             | Ω                | 0       |



| Parameter | Description   | Units              | Default |
|-----------|---|--------------------|---------|
| RS        | Source ohmic resistance   | $\Omega$           | 0       |
| TEMPMODEL | Specification to type of parameter interpolation over temperature (see User Guide section 5.3 | –                  | NONE    |
| TNOM      | Nominal device temperature  | $^{\circ}\text{C}$ | 27      |
| VTO       | Threshold voltage   | V                  | 0       |

Table 2.25: MESFET Model Parameters.

### MESFET Level selection

**Xyce** supports two MESFET models. LEVEL=1, the default, is the SPICE 3f5 treatment. This model employs a doping profile parameter B. When B=1, the original SPICE square law is exactly implemented, and when B=0.6 the model is close to that of Shockley.

When LEVEL=2 is selected, the Shockley model is used with some additional physics effects: channel length modulation and the effect of gate electric field on mobility. An additional parameter, DELTA, is added to the LEVEL 2 model that allows the user to adjust the saturation voltage.

## MOS Field Effect Transistor (MOSFET)

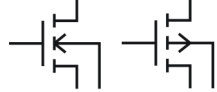
|                               |  |
|-------------------------------|--|
| <b>General Form</b>           | <pre>M&lt;name&gt; &lt;drain node&gt; &lt;gate node&gt; &lt;source node&gt; + &lt;bulk/substrate node&gt; &lt;model name&gt; + [L=&lt;value&gt;] [W=&lt;value&gt;] + [AD=&lt;value&gt;] [AS=&lt;value&gt;] + [PD=&lt;value&gt;] [PS=&lt;value&gt;] + [NRD=&lt;value&gt;] [NRS=&lt;value&gt;] + [M=&lt;value&gt;] [IC=&lt;value, ...&gt;]</pre>   |
| <b>Special Form (BSIMSOI)</b> | <pre>M&lt;name&gt; &lt;drain node&gt; &lt;gate node&gt; &lt;source node&gt; + &lt;substrate node (E)&gt; + [&lt;External body contact (P)&gt;] + [&lt;internal body contact (B)&gt;] + [&lt;temperature node (T)&gt;] + &lt;model name&gt; + [L=&lt;value&gt;] [W=&lt;value&gt;] + [AD=&lt;value&gt;] [AS=&lt;value&gt;] + [PD=&lt;value&gt;] [PS=&lt;value&gt;] + [NRD=&lt;value&gt;] [NRS=&lt;value&gt;] [NRB=&lt;value&gt;] + [BJTOFF=&lt;value&gt;] + [IC=&lt;val&gt;, &lt;val&gt;, &lt;val&gt;, &lt;val&gt;, &lt;val&gt;] + [RTHO=&lt;val&gt;] [CTHO=&lt;val&gt;] + [NBC=&lt;val&gt;] [NSEG=&lt;val&gt;] [PDBCP=&lt;val&gt;] [PSBCP=&lt;val&gt;] + [AGBCP=&lt;val&gt;] [AEBCP=&lt;val&gt;] [VBSUSR=&lt;val&gt;] [TNODEOUT] + [FRBODY=&lt;val&gt;] [M=&lt;value&gt;]</pre> |
| <b>Examples</b>               | <pre>M5 4 12 3 0 PNOM L=20u W=10u M3 5 13 10 0 PSTRONG M6 7 13 10 0 PSTRONG M=2 M8 10 12 100 100 NWEAK L=30u W=20u + AD=288p AS=288p PD=60u PS=60u NRD=14 NRS=24</pre>   |
| <b>Symbols</b>                |   |
| <b>Model Form</b>             | <pre>.MODEL &lt;model name&gt; NMOS [model parameters] .MODEL &lt;model name&gt; PMOS [model parameters]</pre>   |

---

**Parameters  
and Options**

---

L and W

The MOSFET channel length and width that are decreased to get the actual channel length and width. They may be given in the device .MODEL or .OPTIONS statements. The value in the device statement overrides the value in the model statement, which overrides the value in the .OPTIONS statement. Defaults for L and W may be set in the .OPTIONS statement. If L or W values are not given, their default value is 100 u.

AD and AS

The drain and source diffusion areas. Defaults for AD and AS can be set in the .OPTIONS statement. If AD or AS defaults are not set, their default value is 0.

PD and PS

The drain and source diffusion perimeters. Their default value is 0.

---

---

 NRD, NRS

Multipliers (in units of squares) that can be multiplied by  $R_{SH}$  to yield the parasitic (ohmic) resistances of the drain ( $R_D$ ) and source ( $R_S$ ), respectively. NRD, NRS default to 0.

Consider a square sheet of resistive material. Analysis shows that the resistance between two parallel edges of such a sheet depends upon its composition and thickness, but is independent of its size as long as it is square. In other words, the resistance will be the same whether the square's edge is 2 mm, 2 cm, or 2 m. For this reason, the sheet resistance of such a layer, abbreviated  $R_{SH}$ , has units of ohms per square.

M

If specified, the value is used as a number of parallel MOSFETs to be simulated. For example, if  $M=2$  is specified, we simulate two identical mosfets connected to the same nodes in parallel.

**Parameters**  
**and Options (cont.)**

IC

The BSIM3 (model level 9), BSIM4 (model level 14) and BSIMSOI (model level 10) allow one to specify the initial voltage difference across nodes of the device during the DC operating point calculation. For the BSIM3 and BSIM4 the syntax is  $IC= V_{ds}, V_{gs}, V_{bs}$  where  $V_{ds}$  is the voltage difference between the drain and source,  $V_{gs}$  is the voltage difference between the gate and source and  $V_{bs}$  is the voltage difference between the body and source. The BSIMSOI device's initial condition syntax is  $IC= V_{ds}, V_{gs}, V_{bs}, V_{es}, V_{ps}$  where the two extra terms are the voltage difference between the substrate and source, and the external body and source nodes respectively. Note that for any of these lists of voltage differences, fewer than the full number of options may be specified.

For example, IC=5.0 specifies an initial condition on  $V_{ds}$  but does not specify any initial conditions on the other nodes. Therefore, one cannot specify  $V_{gs}$  without specifying  $V_{ds}$ , etc. It is illegal to specify initial conditions on any nodes that are tied together. Xyce attempts to catch such errors, but complex circuits may stymie this error trap.

---

---

There are a large number of extra instance parameters and optional nodes available for the BSIMSOI (level 10) MOSFET.

substrate node

The fourth node of the BSIMSOI device is always the substrate node, which is referred to as the E node.

external body contact node

If given, the fifth node is the external body contact node, P. It is connected to the internal body node through a body tie resistor. If P is not given, the internal body node is not accessible from the netlist and floats.

If there are only five nodes specified and TNODEOUT is also specified, the fifth node is the temperature node instead.

internal body contact node

If given, the sixth node is the internal body contact node, B. It is connected to the external body node through a body tie resistor. If B is not given and P is given, the internal body node is not accessible from the netlist, but is still tied to the external body contact through the tie resistance.

If there are only six nodes specified and TNODEOUT is also specified, the sixth node is the temperature node instead.

temperature node

If the parameter TNODEOUT is specified, the final node (fifth, sixth, or seventh) is interpreted as a temperature node. The temperature node is intended for thermal coupling simulation.

BJTOFF

Turns off the parasitic BJT currents.

IC

The IC parameter allows specification of the five junction initial conditions, VDS, VGS, CBS, VES and VPS. VPS is ignored in a four-terminal device.

---

### **BSIMSOI-specific Options**

---

|   |                        |  |
|---|------------------------|--|
|   | RTHO                   | Thermal resistance per unit width. Taken from model card if not given.   |
|   | CTHO                   | Thermal capacitance per unit width. Taken from model card if not given.  |
|   | NBC                    | Number of body contact isolation edge.   |
|   | NSEG                   | Number of segments for channel width partitioning.   |
|   | PDBCP                  | Parasitic perimeter length for body contact at drain side.   |
| <b><u>BSIMSOI-specific</u></b><br><b><u>Options (cont.)</u></b> | PSBCP                  | Parasitic perimeter length for body contact at source side.  |
|   | AGBCP                  | Parasitic gate-to-body overlap area for body contact.  |
|   | AEBCP                  | Parasitic body-to-substrate overlap area for body contact.   |
|   | VBSUSR                 | Optional initial value of VBS specified by user for use in transient analysis. (currently unused in Xyce).   |
|   | FRBODY                 | Layout-dependent body resistance coefficient.  |
|   | <b><u>Comments</u></b> | The simulator provides three MOSFET device models, which differ in the formulation of the I-V characteristic. The LEVEL parameter selects among different models as shown below. |

---

## MOSFET Operating Temperature

Model parameters may be assigned unique measurement temperatures using the `TNOM` model parameter. See the MOSFET model parameters for more information.

### Model Parameters

Tables 2.26, 2.27, 2.28, 2.29, 2.30, and 2.31 give the available model parameters for the levels 1,2,3,6,9 and 10 MOSFETs, respectively.

#### All MOSFET models

The parameters shared by all MOSFET model levels are principally parasitic element values (e.g., series resistance, overlap capacitance, etc.).

#### Model levels 1, and 3

The DC behaviors of the level 1 and 3 MOSFET models are defined by the parameters `VTO`, `KP`, `LAMBDA`, `PHI`, and `GAMMA`. The simulator calculates these if the process parameters (e.g., `TOX`, and `NSUB`) are specified, but these are always overridden by any user-defined values. The `VTO` value is positive (negative) for modeling the enhancement mode and negative (positive) for the depletion mode of N-channel (P-channel) devices.

For MOSFETs, the capacitance model enforces charge conservation, influencing just the Level 1 and 3 models.

Effective device parameter lengths and widths are calculated as follows:

$$P_i = P_0 + P_L/L_e + P_W/W_e$$

where

$$\begin{aligned} L_e &= \text{effective length} &= \mathbf{L} - (2 \cdot \mathbf{LD}) \\ W_e &= \text{effective width} &= \mathbf{W} - (2 \cdot \mathbf{WD}) \end{aligned}$$

See `.MODEL` (model definition) for more information.

#### Model level 9 (BSIM3 version 3.2.2)

The University of California, Berkeley BSIM3 model is a physical-based model with a large number of dependencies on essential dimensional and processing parameters. It incorporates the key effects that are critical in modeling deep-submicrometer MOSFETs. These include threshold voltage reduction, nonuniform doping, mobility reduction due to the vertical



field, bulk charge effect, carrier velocity saturation, drain-induced barrier lowering (DIBL), channel length modulation (CLM), hot-carrier-induced output resistance reduction, sub-threshold conduction, source/drain parasitic resistance, substrate current induced body effect (SCBE) and drain voltage reduction in LDD structure.

The BSIM3 Version 3.2.2 model is a deep submicron MOSFET model with several major enhancements (over earlier versions). These include a single I-V formula used to define the current and output conductance for operating regions, improved narrow width device modeling, a superior capacitance model with improved short and narrow geometry models, a new relaxation-time model to better transient modeling and enhanced model fitting of assorted W/L ratios using a single parameter set. This version preserves the large number of integrated dependencies on dimensional and processing parameters of the Version 2 model. For further information, see Reference [10].

#### Additional notes

1. If any of the following BSIM3 3.2.2 model parameters are not specified, they are computed via the following:

If **VTHO** is not specified, then:

$$\mathbf{VTHO} = \mathbf{VFB} + \phi_s \mathbf{K1} \sqrt{\phi_s}$$

where:

$$\mathbf{VFB} = -1.0$$

If **VTHO** is given, then:

$$\mathbf{VFB} = \mathbf{VTHO} - \phi_s + \mathbf{K1} \sqrt{phi_s}$$

$$\mathbf{VBX} = \phi_s - \frac{q \cdot \mathbf{NCH} \cdot \mathbf{XT}^2}{2\epsilon_{si}}$$

$$\mathbf{CF} = \left( \frac{2\epsilon_{ox}}{\pi} \right) \ln \left( 1 + \frac{1}{4 \times 10^7 \cdot \mathbf{TOX}} \right)$$

where:

$$E_g(T) = \text{the energy bandgap at temperature } T = 1.16 - \frac{T^2}{7.02 \times 10^4 (T + 1108)}$$

2. If **K1** and **K2** are not given then they are computed via the following:

$$\mathbf{K1} = \mathbf{GAMMA2} - 2 \cdot \mathbf{K2} \sqrt{\phi_s - \mathbf{VBM}}$$

$$\mathbf{K2} = \frac{(\mathbf{GAMMA1} - \mathbf{GAMMA2})(\sqrt{\phi_s - \mathbf{VBX}} - \sqrt{\phi_s})}{2\sqrt{\phi_s}(\sqrt{\phi_s - \mathbf{VBM}} - \sqrt{\phi_s}) + \mathbf{VBM}}$$

where:

$$\begin{aligned}\phi_s &= 2V_t \ln\left(\frac{\mathbf{NCH}}{n_i}\right) \\ V_t &= kT/q \\ n_i &= 1.45 \times 10^{10} \left(\frac{T}{300.15}\right)^{1.5} \exp\left(21.5565981 - \frac{E_g(T)}{2V_t}\right)\end{aligned}$$

3. If **NCH** is not specified and **GAMMA1** is, then:

$$\mathbf{NCH} = \frac{\mathbf{GAMMA1}^2 \times \mathbf{COX}^2}{2q\varepsilon_{si}}$$

If **GAMMA1** and **NCH** are not specified, then **NCH** defaults to  $1.7 \times 10^{23} \text{ m}^{-3}$  and **GAMMA1** is computed using **NCH**:

$$\mathbf{GAMMA1} = \frac{\sqrt{2q\varepsilon_{si} \cdot \mathbf{NCH}}}{\mathbf{COX}}$$

If **GAMMA2** is not specified, then:

$$\mathbf{GAMMA2} = \frac{\sqrt{2q\varepsilon_{si} \cdot \mathbf{NSUB}}}{\mathbf{COX}}$$

4. If **CGSO** is not specified and **DLC** > 0, then:

$$\mathbf{CGSO} = \begin{cases} 0, & ((\mathbf{DLC} \cdot \mathbf{COX}) - \mathbf{CGSL}) < 0 \\ 0.6 \cdot \mathbf{XJ} \cdot \mathbf{COX}, & ((\mathbf{DLC} \cdot \mathbf{COX}) - \mathbf{CGSL}) \geq 0 \end{cases}$$

5. If **CGDO** is not specified and **DLC** > 0, then:

$$\mathbf{CGDO} = \begin{cases} 0, & ((\mathbf{DLC} \cdot \mathbf{COX}) - \mathbf{CGSL}) < 0 \\ 0.6 \cdot \mathbf{XJ} \cdot \mathbf{COX}, & ((\mathbf{DLC} \cdot \mathbf{COX}) - \mathbf{CGSL}) \geq 0 \end{cases}$$

#### Model level 10 (BSIMSOI version 3.2)

The BSIMSOI is an international standard model for SOI (silicon on insulator) circuit design and is formulated on top of the BSIM3v3 framework. A detailed description can be found in the BSIMSOI 3.1 Users' Manual [11] and the BSIMSOI 3.2 release notes [12].

This version (v3.2) of the BSIMSOI includes three depletion models; the partially depleted BSIMSOI PD (soiMod=0), the fully depleted BSIMSOI FD (soiMod=2), and the unified SOI model (soiMod=1).

BSIMPD is the Partial-Depletion (PD) mode of the BSIMSOI. A typical PD SOI MOSFET is formed on a thin SOI film which is layered on top of a buried oxide. BSIMPD has the following features and enhancements:

- Real floating body simulation of both I-V and C-V. The body potential is determined by the balance of all body current components.
- An improved parasitic bipolar current model. This includes enhancements in the various diode leakage components, second order effects (high-level injection and Early effect), diffusion charge equation, and temperature dependence of the diode junction capacitance.
- An improved impact-ionization current model. The contribution from BJT current is also modeled by the parameter Fbjtii.
- A gate-to-body tunneling current model, which is important to thin-oxide SOI technologies.
- Enhancements in the threshold voltage and bulk charge formulation of the high positive body bias regime.
- Instance parameters (Pdbcp, Psbcp, Agbcp, Aebcp, Nbc) are provided to model the parasitics of devices with various body-contact and isolation structures.
- An external body node (the 6th node) and other improvements are introduced to facilitate the modeling of distributed body resistance.
- Self heating. An external temperature node (the 7th node) is supported to facilitate the simulation of thermal coupling among neighboring devices.
- A unique SOI low frequency noise model, including a new excess noise resulting from the floating body effect.
- Width dependence of the body effect is modeled by parameters (K1,K1w1,K1w2).
- Improved history dependence of the body charges with two new parameters (Fbody, DLCB).
- An instance parameter Vbsusr is provided for users to set the transient initial condition of the body potential.
- The new charge-thickness capacitance model introduced in BSIM3v3.2, capMod=3, is included.

The following tables gives the parameters for the MOSFET, levels 1 through 10.

| Level=1<br>Parameter          | Description   | Units            | Default |
|-------------------------------|---|------------------|---------|
| <b>Capacitance Parameters</b> |   |                  |         |
| CBD                           | Zero-bias bulk-drain p-n capacitance  | F                | 0       |
| CBS                           | Zero-bias bulk-source p-n capacitance   | F                | 0       |
| CGBO                          | Gate-bulk overlap capacitance/channel length  | F/m              | 0       |
| CGDO                          | Gate-drain overlap capacitance/channel width  | F/m              | 0       |
| CGSO                          | Gate-source overlap capacitance/channel width   | F/m              | 0       |
| CJ                            | Bulk p-n zero-bias bottom capacitance/area  | F/m <sup>2</sup> | 0       |
| CJSW                          | Bulk p-n zero-bias sidewall capacitance/area  | F/m <sup>2</sup> | 0       |
| FC                            | Bulk p-n forward-bias capacitance coefficient   | –                | 0.5     |
| <b>Control Parameters</b>     |   |                  |         |
| TEMPMODEL                     | Specification to type of parameter interpolation over temperature (see User Guide section 5.3 | –                | NONE    |
| <b>Current Parameters</b>     |   |                  |         |
| IS                            | Bulk p-n saturation current   | A                | 1e-14   |
| <b>Doping Parameters</b>      |   |                  |         |
| LD                            | Lateral diffusion length  | m                | 0       |
| MJ                            | Bulk p-n bottom grading coefficient   | –                | 0.5     |
| MJSW                          | Bulk p-n sidewall grading coefficient   | –                | 0.5     |
| NSUB                          | Substrate doping density  | cm <sup>-3</sup> | 0       |
| <b>Flicker Parameters</b>     |   |                  |         |
| AF                            | Flicker noise exponent  | –                | 1       |
| KF                            | Flicker noise coefficient   | –                | 0       |
| <b>Geometry Parameters</b>    |   |                  |         |
| L                             | Default channel length  | m                | 0.0001  |
| TOX                           | Gate oxide thickness  | m                | 1e-07   |
| W                             | Default channel width   | m                | 0.0001  |
| <b>Material Parameters</b>    |   |                  |         |
| TPG                           | Gate material type (-1 = same as substrate, 0 = aluminum, 1 = opposite of substrate           | –                | 0       |
| <b>Resistance Parameters</b>  |   |                  |         |
| RD                            | Drain ohmic resistance  | Ω                | 0       |
| RS                            | Source ohmic resistance   | Ω                | 0       |

| Level=1<br>Parameter                 | Description                              | Units        | Default |
|--------------------------------------|--|--------------|---------|
| RSH                                  | Drain, source diffusion sheet resistance | $\Omega$     | 0       |
| <b><i>Process Parameters</i></b>     |  |              |         |
| GAMMA                                | Bulk threshold parameter                 | $V^{1/2}$    | 0       |
| JS                                   | Bulk p-n saturation current density      | $A/m^2$      | 0       |
| KP                                   | Transconductance coefficient             | $A/V^2$      | 2e-05   |
| LAMBDA                               | Channel-length modulation                | $V^{-1}$     | 0       |
| NSS                                  | Surface state density                    | $cm^{-2}$    | 0       |
| PHI                                  | Surface potential                        | V            | 0.6     |
| U0                                   | Surface mobility                         | $1/(Vcm^2s)$ | 600     |
| <b><i>Temperature Parameters</i></b> |  |              |         |
| TNOM                                 | Nominal device temperature               | $^{\circ}C$  | 27      |
| <b><i>Voltage Parameters</i></b>     |  |              |         |
| PB                                   | Bulk p-n bottom potential                | V            | 0.8     |
| VTO                                  | Zero-bias threshold voltage              | V            | 0       |

Table 2.26: MOSFET level 1 Device Model Parameters.

| Level=2<br>Parameter          | Description  | Units            | Default |
|-------------------------------|--|------------------|---------|
| DELTA                         | Width effect on threshold  | –                | 0       |
| NEFF                          | Total channel charge coeff.  | –                | 1       |
| NFS                           | Fast surface state density   | –                | 0       |
| UCRIT                         | Crit. field for mob. degradation   | –                | 10000   |
| UEXP                          | Crit. field exp for mob. deg.  | –                | 0       |
| VMAX                          | Maximum carrier drift velocity   | –                | 0       |
| XJ                            | Junction depth   | –                | 0       |
| <b>Capacitance Parameters</b> |  |                  |         |
| CBD                           | Zero-bias bulk-drain p-n capacitance   | F                | 0       |
| CBS                           | Zero-bias bulk-source p-n capacitance  | F                | 0       |
| CGBO                          | Gate-bulk overlap capacitance/channel length   | F/m              | 0       |
| CGDO                          | Gate-drain overlap capacitance/channel width   | F/m              | 0       |
| CGSO                          | Gate-source overlap capacitance/channel width  | F/m              | 0       |
| CJ                            | Bulk p-n zero-bias bottom capacitance/area   | F/m <sup>2</sup> | 0       |
| CJSW                          | Bulk p-n zero-bias sidewall capacitance/area   | F/m <sup>2</sup> | 0       |
| FC                            | Bulk p-n forward-bias capacitance coefficient  | –                | 0.5     |
| <b>Control Parameters</b>     |  |                  |         |
| TEMPMODEL                     | Specification to type of parameter interpolation over temperature (see User Guide section 5.3) | –                | NONE    |
| <b>Current Parameters</b>     |  |                  |         |
| IS                            | Bulk p-n saturation current  | A                | 1e-14   |
| <b>Doping Parameters</b>      |  |                  |         |
| LD                            | Lateral diffusion length   | m                | 0       |
| MJ                            | Bulk p-n bottom grading coefficient  | –                | 0.5     |
| MJSW                          | Bulk p-n sidewall grading coefficient  | –                | 0.5     |
| NSUB                          | Substrate doping density   | cm <sup>-3</sup> | 0       |
| <b>Flicker Parameters</b>     |  |                  |         |
| AF                            | Flicker noise exponent   | –                | 1       |
| KF                            | Flicker noise coefficient  | –                | 0       |
| <b>Geometry Parameters</b>    |  |                  |         |
| L                             | Default channel length   | m                | 0.0001  |

| Level=2<br>Parameter          | Description  | Units        | Default     |
|-------------------------------|--|--------------|-------------|
| TOX                           | Gate oxide thickness   | m            | 1e-07       |
| W                             | Default channel width  | m            | 0.0001      |
| <b>Material Parameters</b>    |  |              |             |
| TPG                           | Gate material type (-1 = same as substrate, 0 = aluminum, 1 = opposite of substrate) | –            | 0           |
| <b>Resistance Parameters</b>  |  |              |             |
| RD                            | Drain ohmic resistance   | $\Omega$     | 0           |
| RS                            | Source ohmic resistance  | $\Omega$     | 0           |
| RSH                           | Drain, source diffusion sheet resistance   | $\Omega$     | 0           |
| <b>Process Parameters</b>     |  |              |             |
| GAMMA                         | Bulk threshold parameter   | $V^{1/2}$    | 0           |
| JS                            | Bulk p-n saturation current density  | $A/m^2$      | 0           |
| KP                            | Transconductance coefficient   | $A/V^2$      | 2.07189e-05 |
| LAMBDA                        | Channel-length modulation  | $V^{-1}$     | 0           |
| NSS                           | Surface state density  | $cm^{-2}$    | 0           |
| PHI                           | Surface potential  | V            | 0.6         |
| U0                            | Surface mobility   | $1/(Vcm^2s)$ | 600         |
| <b>Temperature Parameters</b> |  |              |             |
| TNOM                          | Nominal device temperature   | $^{\circ}C$  | 27          |
| <b>Voltage Parameters</b>     |  |              |             |
| PB                            | Bulk p-n bottom potential  | V            | 0.8         |
| VTO                           | Zero-bias threshold voltage  | V            | 0           |

Table 2.27: MOSFET level 2 Device Model Parameters.

| Level=3<br>Parameter          | Description   | Units            | Default |
|-------------------------------|---|------------------|---------|
| KAPPA                         | Saturation field factor   | –                | 0.2     |
| <b>Capacitance Parameters</b> |   |                  |         |
| CBD                           | Zero-bias bulk-drain p-n capacitance  | F                | 0       |
| CBS                           | Zero-bias bulk-source p-n capacitance   | F                | 0       |
| CGBO                          | Gate-bulk overlap capacitance/channel length  | F/m              | 0       |
| CGDO                          | Gate-drain overlap capacitance/channel width  | F/m              | 0       |
| CGSO                          | Gate-source overlap capacitance/channel width   | F/m              | 0       |
| CJ                            | Bulk p-n zero-bias bottom capacitance/area  | F/m <sup>2</sup> | 0       |
| CJSW                          | Bulk p-n zero-bias sidewall capacitance/area  | F/m <sup>2</sup> | 0       |
| FC                            | Bulk p-n forward-bias capacitance coefficient   | –                | 0.5     |
| <b>Control Parameters</b>     |   |                  |         |
| TEMPMODEL                     | Specification to type of parameter interpolation over temperature (see User Guide section 5.3 | –                | NONE    |
| <b>Current Parameters</b>     |   |                  |         |
| IS                            | Bulk p-n saturation current   | A                | 1e-14   |
| <b>Doping Parameters</b>      |   |                  |         |
| LD                            | Lateral diffusion length  | m                | 0       |
| MJ                            | Bulk p-n bottom grading coefficient   | –                | 0.5     |
| MJSW                          | Bulk p-n sidewall grading coefficient   | –                | 0.33    |
| NSUB                          | Substrate doping density  | cm <sup>-3</sup> | 0       |
| <b>Flicker Parameters</b>     |   |                  |         |
| AF                            | Flicker noise exponent  | –                | 1       |
| KF                            | Flicker noise coefficient   | –                | 0       |
| <b>Geometry Parameters</b>    |   |                  |         |
| L                             | Default channel length  | m                | 0.0001  |
| TOX                           | Gate oxide thickness  | m                | 1e-07   |
| W                             | Default channel width   | m                | 0.0001  |
| XJ                            | Metallurgical junction depth  | m                | 0       |
| <b>Material Parameters</b>    |   |                  |         |
| TPG                           | Gate material type (-1 = same as substrate, 0 = aluminum, 1 = opposite of substrate           | –                | 1       |
| <b>Resistance Parameters</b>  |   |                  |         |



| Level=3<br>Parameter          | Description                              | Units        | Default     |
|-------------------------------|--|--------------|-------------|
| RD                            | Drain ohmic resistance                   | $\Omega$     | 0           |
| RS                            | Source ohmic resistance                  | $\Omega$     | 0           |
| RSH                           | Drain, source diffusion sheet resistance | $\Omega$     | 0           |
| <b>Process Parameters</b>     |  |              |             |
| DELTA                         | Width effect on threshold                | –            | 0           |
| ETA                           | Static feedback                          | –            | 0           |
| GAMMA                         | Bulk threshold parameter                 | $V^{1/2}$    | 0           |
| JS                            | Bulk p-n saturation current density      | $A/m^2$      | 0           |
| KP                            | Transconductance coefficient             | $A/V^2$      | 2.07189e-05 |
| NFS                           | Fast surface state density               | $cm^{-2}$    | 0           |
| NSS                           | Surface state density                    | $cm^{-2}$    | 0           |
| PHI                           | Surface potential                        | V            | 0.6         |
| THETA                         | Mobility modulation                      | $V^{-1}$     | 0           |
| U0                            | Surface mobility                         | $1/(Vcm^2s)$ | 600         |
| VMAX                          | Maximum drift velocity                   | m/s          | 0           |
| <b>Temperature Parameters</b> |  |              |             |
| TNOM                          | Nominal device temperature               | $^{\circ}C$  | 27          |
| <b>Voltage Parameters</b>     |  |              |             |
| PB                            | Bulk p-n bottom potential                | V            | 0.8         |
| VTO                           | Zero-bias threshold voltage              | V            | 0           |

Table 2.28: MOSFET level 3 Device Model Parameters.

| Level=6<br>Parameter          | Description   | Units            | Default |
|-------------------------------|---|------------------|---------|
| GAMMA                         | Bulk threshold parameter  | –                | 0       |
| GAMMA1                        | Bulk threshold parameter 1  | –                | 0       |
| KC                            | Saturation current factor   | –                | 5e-05   |
| KV                            | Saturation voltage factor   | –                | 2       |
| LAMBDA                        | Channel length modulation param.  | –                | 0       |
| LAMBDA0                       | Channel length modulation param. 0  | –                | 0       |
| LAMBDA1                       | Channel length modulation param. 1  | –                | 0       |
| NC                            | Saturation current coeff.   | –                | 1       |
| NV                            | Saturation voltage coeff.   | –                | 0.5     |
| NVTH                          | Threshold voltage coeff.  | –                | 0.5     |
| PS                            | Sat. current modification par.  | –                | 0       |
| SIGMA                         | Static feedback effect par.   | –                | 0       |
| <b>Capacitance Parameters</b> |   |                  |         |
| CBD                           | Zero-bias bulk-drain p-n capacitance  | F                | 0       |
| CBS                           | Zero-bias bulk-source p-n capacitance   | F                | 0       |
| CGBO                          | Gate-bulk overlap capacitance/channel length  | F/m              | 0       |
| CGDO                          | Gate-drain overlap capacitance/channel width  | F/m              | 0       |
| CGSO                          | Gate-source overlap capacitance/channel width   | F/m              | 0       |
| CJ                            | Bulk p-n zero-bias bottom capacitance/area  | F/m <sup>2</sup> | 0       |
| CJSW                          | Bulk p-n zero-bias sidewall capacitance/area  | F/m <sup>2</sup> | 0       |
| FC                            | Bulk p-n forward-bias capacitance coefficient   | –                | 0.5     |
| <b>Control Parameters</b>     |   |                  |         |
| TEMPMODEL                     | Specification to type of parameter interpolation over temperature (see User Guide section 5.3 | –                | NONE    |
| <b>Current Parameters</b>     |   |                  |         |
| IS                            | Bulk p-n saturation current   | A                | 1e-14   |
| <b>Doping Parameters</b>      |   |                  |         |
| LD                            | Lateral diffusion length  | m                | 0       |
| MJ                            | Bulk p-n bottom grading coefficient   | –                | 0.5     |
| MJSW                          | Bulk p-n sidewall grading coefficient   | –                | 0.5     |
| NSUB                          | Substrate doping density  | cm <sup>-3</sup> | 0       |

| Level=6<br>Parameter                 | Description  | Units                  | Default |
|--------------------------------------|--|------------------------|---------|
| <b><i>Geometry Parameters</i></b>    |  |                        |         |
| TOX                                  | Gate oxide thickness   | m                      | 1e-07   |
| <b><i>Material Parameters</i></b>    |  |                        |         |
| TPG                                  | Gate material type (-1 = same as substrate, 0 = aluminum, 1 = opposite of substrate) | –                      | 1       |
| <b><i>Resistance Parameters</i></b>  |  |                        |         |
| RD                                   | Drain ohmic resistance   | $\Omega$               | 0       |
| RS                                   | Source ohmic resistance  | $\Omega$               | 0       |
| RSH                                  | Drain, source diffusion sheet resistance   | $\Omega$               | 0       |
| <b><i>Process Parameters</i></b>     |  |                        |         |
| JS                                   | Bulk p-n saturation current density  | A/m <sup>2</sup>       | 0       |
| NSS                                  | Surface state density  | cm <sup>-2</sup>       | 0       |
| PHI                                  | Surface potential  | V                      | 0.6     |
| U0                                   | Surface mobility   | 1/(Vcm <sup>2</sup> s) | 600     |
| <b><i>Temperature Parameters</i></b> |  |                        |         |
| TNOM                                 | Nominal device temperature   | °C                     | 27      |
| <b><i>Voltage Parameters</i></b>     |  |                        |         |
| PB                                   | Bulk p-n bottom potential  | V                      | 0.8     |
| VTO                                  | Zero-bias threshold voltage  | V                      | 0       |

Table 2.29: MOSFET level 6 Device Model Parameters.

| Level=9<br>Parameter                 | Description   | Units             | Default     |
|--------------------------------------|---|-------------------|-------------|
| <b><i>Bin Parameters</i></b>         |   |                   |             |
| LMAX                                 | Maximum channel length  | m                 | 1           |
| LMIN                                 | Minimum channel length  | m                 | 0           |
| WMAX                                 | Maximum channel width   | m                 | 1           |
| WMIN                                 | Minimum channel width   | m                 | 0           |
| <b><i>Capacitance Parameters</i></b> |   |                   |             |
| ACDE                                 | Exponential coefficient for charge thickness in capmod = 3 for accumulation and depletion regions | m/V               | 1           |
| CF                                   | Firing field capacitance  | F/m               | 7.29897e-11 |
| CGBO                                 | Gate-bulk overlap capacitance per unit channel length   | F/m               | 0           |
| CGDL                                 | Light-doped drain-gate region overlap capacitance   | F/m               | 0           |
| CGDO                                 | Non-LLD region drain-gate overlap capacitance per unit channel length                             | F/m               | 2.07188e-10 |
| CGSL                                 | Light-doped source-gate region overlap capacitance  | F/m               | 0           |
| CGSO                                 | Non-LLD region source-gate overlap capacitance per unit channel length                            | F/m               | 2.07188e-10 |
| CJ                                   | Bulk p-n zero-bias bottom capacitance/area  | F/m <sup>2</sup>  | 0.0005      |
| CJSW                                 | Bulk p-n zero-bias sidewall capacitance/area  | F/m <sup>2</sup>  | 5e-10       |
| CJSWG                                | Source/Drain gate sidewall junction capacitance per unit width                                    | F/m               | 5e-10       |
| CKAPPA                               | Coefficient for lightly doped region overlap capacitance firing field capacitance                 | F/m               | 0.6         |
| CLC                                  | Constant term for short-channel model   | m                 | 1e-07       |
| CLE                                  | Exponential term for the short-channel model  | -                 | 0.6         |
| DLC                                  | Length offset fitting parameter from C-V  | m                 | 0           |
| DWC                                  | Width offset fitting parameter from C-V   | m                 | 0           |
| LACDE                                | Length dependence of ACDE   | m <sup>2</sup> /V | 0           |
| LCF                                  | Length dependence of CF   | F                 | 0           |
| LCGDL                                | Length dependence of CGDL   | F                 | 0           |
| LCGSL                                | Length dependence of CGSL   | F                 | 0           |
| LCKAPPA                              | Length dependence of CKAPPA   | F                 | 0           |

| Level=9<br>Parameter | Description   | Units             | Default |
|----------------------|---|-------------------|---------|
| LCLC                 | Length dependence of CLC  | m <sup>2</sup>    | 0       |
| LCLE                 | Length dependence of CLE  | m                 | 0       |
| LMOIN                | Length dependence of MOIN   | m                 | 0       |
| LNOFF                | Length dependence of NOFF   | m                 | 0       |
| LVFBCV               | Length dependence of VFBCV  | Vm                | 0       |
| LVOFFCV              | Length dependence of VOFFCV   | Vm                | 0       |
| MJSWG                | Source/Drain gate sidewall junction capacitance grading coefficient | –                 | 0.33    |
| MOIN                 | Coefficient for the gate-bias dependent surface potential           | –                 | 15      |
| NOFF                 | CV parameter in Vgsteff, CV for weak to strong inversion            | –                 | 1       |
| PACDE                | Cross-term dependence of ACDE                                       | m <sup>3</sup> /V | 0       |
| PBSW                 | Source/drain side junction built-in potential                       | V                 | 1       |
| PBSWG                | Source/drain gate sidewall junction built-in potential              | V                 | 1       |
| PCF                  | Cross-term dependence of CF   | Fm                | 0       |
| PCGDL                | Cross-term dependence of CGDL                                       | Fm                | 0       |
| PCGSL                | Cross-term dependence of CGSL                                       | Fm                | 0       |
| PCKAPPA              | Cross-term dependence of CKAPPA                                     | Fm                | 0       |
| PCLC                 | Cross-term dependence of CLC  | m <sup>3</sup>    | 0       |
| PCLE                 | Cross-term dependence of CLE  | m <sup>2</sup>    | 0       |
| PMOIN                | Cross-term dependence of MOIN                                       | m <sup>2</sup>    | 0       |
| PNOFF                | Cross-term dependence of NOFF                                       | m <sup>2</sup>    | 0       |
| PVFBCV               | Cross-term dependence of VFBCV                                      | Vm <sup>2</sup>   | 0       |
| PVOFFCV              | Cross-term dependence of VOFFCV                                     | Vm <sup>2</sup>   | 0       |
| VFBCV                | Flat-band voltage parameter (for CAPMOD = 0 only)                   | V                 | -1      |
| VOFFCV               | CV parameter in Vgsteff, CV for weak to strong inversion            | V                 | 0       |
| WACDE                | Width dependence of ACDE  | m <sup>2</sup> /V | 0       |
| WCF                  | Width dependence of CF  | F                 | 0       |
| WCGDL                | Width dependence of CGDL  | F                 | 0       |
| WCGSL                | Width dependence of CGSL  | F                 | 0       |
| WCKAPPA              | Width dependence of CKAPPA  | F                 | 0       |

| Level=9<br>Parameter      | Description                                       | Units                | Default |
|---------------------------|---|----------------------|---------|
| WCLC                      | Width dependence of CLC                           | m <sup>2</sup>       | 0       |
| WCLE                      | Width dependence of CLE                           | m                    | 0       |
| WMOIN                     | Width dependence of MOIN                          | m                    | 0       |
| WNOFF                     | Width dependence of NOFF                          | m                    | 0       |
| WVBCV                     | Width dependence of VFBCV                         | Vm                   | 0       |
| WVOFFCV                   | Width dependence of VOFFCV                        | Vm                   | 0       |
| XPART                     | Charge partitioning rate flag                     | –                    | 0       |
| <b>Control Parameters</b> |   |                      |         |
| BINUNIT                   | Binning unit selector                             | –                    | 1       |
| CAPMOD                    | Flag for capacitance models                       | –                    | 3       |
| MOBMOD                    | Mobility model selector                           | –                    | 1       |
| NOIMOD                    | Flag for noise models                             | –                    | 1       |
| PARAMCHK                  | Parameter value check                             | –                    | 0       |
| VERSION                   | Version number                                    | –                    | 3.2.2   |
| <b>DC Parameters</b>      |   |                      |         |
| A0                        | Bulk charge effect coefficient for channel length | –                    | 1       |
| A1                        | First non-saturation effect parameter             | V <sup>-1</sup>      | 0       |
| A2                        | Second non-saturation factor                      | –                    | 1       |
| AGS                       | Gate-bias coefficient of abulk                    | V <sup>-1</sup>      | 0       |
| ALPHA0                    | First parameter of impact-ionization current      | m/V                  | 0       |
| ALPHA1                    | Isub parameter for length scaling                 | V <sup>-1</sup>      | 0       |
| B0                        | Bulk charge effect coefficient for channel width  | m                    | 0       |
| B1                        | Bulk charge effect offset                         | m                    | 0       |
| BETA0                     | Second parameter of impact-ionization current     | V                    | 30      |
| CDSC                      | Drain/source to channel coupling capacitance      | F/m <sup>2</sup>     | 0.00024 |
| CDSCB                     | Body-bias sensitivity of CDSC                     | F/(Vm <sup>2</sup> ) | 0       |
| CDSCD                     | Drain-bias sensitivity of CDSC                    | F/(Vm <sup>2</sup> ) | 0       |
| CIT                       | Interface trap capacitance                        | F/m <sup>2</sup>     | 0       |
| DELTA                     | Effective Vds parameter                           | V                    | 0.01    |

| Level=9<br>Parameter | Description   | Units              | Default |
|----------------------|---|--------------------|---------|
| DROUT                | L-dependence Coefficient of the DIBL correction parameter in Rout                                 | –                  | 0.56    |
| DSUB                 | DIBL coefficient exponent in subthreshold region  | –                  | 0.56    |
| DVT0                 | First coefficient of short-channel effect effect on threshold voltage                             | –                  | 2.2     |
| DVT0W                | First coefficient of narrow-width effect effect on threshold voltage for small channel length     | m <sup>-1</sup>    | 0       |
| DVT1                 | Second coefficient of short-channel effect effect on threshold voltage                            | –                  | 0.53    |
| DVT1W                | Second coefficient of narrow-width effect effect on threshold voltage for small channel length    | m <sup>-1</sup>    | 5.3e+06 |
| DVT2                 | Body-bias coefficient of short-channel effect effect on threshold voltage                         | V <sup>-1</sup>    | -0.032  |
| DVT2W                | Body-bias coefficient of narrow-width effect effect on threshold voltage for small channel length | V <sup>-1</sup>    | -0.032  |
| DWB                  | Coefficient of substrate body bias dependence of Weff   | m/V <sup>1/2</sup> | 0       |
| DWG                  | Coefficient of gate dependence of Weff  | m/V <sup>1/2</sup> | 0       |
| ETA0                 | DIBL coefficient in subthreshold region   | –                  | 0.08    |
| ETAB                 | Body-bias coefficient for the subthreshold DIBL effect  | V <sup>-1</sup>    | -0.07   |
| IJTH                 | Diode limiting current  | A                  | 0.1     |
| JSW                  | Sidewall saturation current per unit length   | A/m                | 0       |
| K1                   | First-order body effect coefficient   | V <sup>1/2</sup>   | 0       |
| K2                   | second-order body effect coefficient  | –                  | 0       |
| K3                   | Narrow width coefficient  | –                  | 80      |
| K3B                  | Body effect coefficient of K3   | V <sup>-1</sup>    | 0       |
| KETA                 | Body-bias coefficient of bulk charge effect   | V <sup>-1</sup>    | -0.047  |
| LA0                  | Length dependence of A0   | m                  | 0       |
| LA1                  | Length dependence of A1   | m/V                | 0       |
| LA2                  | Length dependence of A2   | m                  | 0       |
| LAGS                 | Length dependence of AGS  | m/V                | 0       |
| LALPHA0              | Length dependence of ALPHA0   | m <sup>2</sup> /V  | 0       |

| Level=9<br>Parameter | Description  | Units                            | Default |
|----------------------|--|----------------------------------|---------|
| LALPHA1              | Length dependence of ALPHA1                              | m/V                              | 0       |
| LB0                  | Length dependence of B0                                  | m <sup>2</sup>                   | 0       |
| LB1                  | Length dependence of B1                                  | m <sup>2</sup>                   | 0       |
| LBETA0               | Length dependence of BETA0                               | Vm                               | 0       |
| LCDSC                | Length dependence of CDSC                                | F/m                              | 0       |
| LCDSCB               | Length dependence of CDSCB                               | F/(Vm)                           | 0       |
| LCDSCD               | Length dependence of CDSCD                               | F/(Vm)                           | 0       |
| LCIT                 | Length dependence of CIT                                 | F/m                              | 0       |
| LDELTA               | Length dependence of DELTA                               | Vm                               | 0       |
| LDROUT               | Length dependence of DROUT                               | m                                | 0       |
| LDSUB                | Length dependence of DSUB                                | m                                | 0       |
| LDVT0                | Length dependence of DVT0                                | m                                | 0       |
| LDVT0W               | Length dependence of DVT0W                               | –                                | 0       |
| LDVT1                | Length dependence of DVT1                                | m                                | 0       |
| LDVT1W               | Length dependence of DVT1W                               | –                                | 0       |
| LDVT2                | Length dependence of DVT2                                | m/V                              | 0       |
| LDVT2W               | Length dependence of DVT2W                               | m/V                              | 0       |
| LDWB                 | Length dependence of DWB                                 | m <sup>2</sup> /V <sup>1/2</sup> | 0       |
| LDWG                 | Length dependence of DWG                                 | m <sup>2</sup> /V <sup>1/2</sup> | 0       |
| LETA0                | Length dependence of ETA0                                | m                                | 0       |
| LETAB                | Length dependence of ETAB                                | m/V                              | 0       |
| LINT                 | Length of offset fitting parameter from I-V without bias | m                                | 0       |
| LK1                  | Length dependence of K1                                  | V <sup>1/2</sup> m               | 0       |
| LK2                  | Length dependence of K2                                  | m                                | 0       |
| LK3                  | Length dependence of K3                                  | m                                | 0       |
| LK3B                 | Length dependence of K3B                                 | m/V                              | 0       |
| LKETA                | Length dependence of KETA                                | m/V                              | 0       |
| LNFACTOR             | Length dependence of NFACTOR                             | m                                | 0       |
| LNGATE               | Length dependence of NGATE                               | m/cm <sup>3</sup>                | 0       |



| Level=9<br>Parameter | Description                          | Units                          | Default      |
|----------------------|--------------------------------------|--------------------------------|--------------|
| LNLX                 | Length dependence of NLX             | m <sup>2</sup>                 | 0            |
| LPCLM                | Length dependence of PCLM            | m                              | 0            |
| LPDIBLC1             | Length dependence of PDIBLC1         | m                              | 0            |
| LPDIBLC2             | Length dependence of PDIBLC2         | m                              | 0            |
| LPDIBLCB             | Length dependence of PDIBLCB         | m/V                            | 0            |
| LPRWB                | Length dependence of PRWB            | m/V <sup>1/2</sup>             | 0            |
| LPRWG                | Length dependence of PRWG            | m/V                            | 0            |
| LPSCBE1              | Length dependence of PSCBE1          | V                              | 0            |
| LPSCBE2              | Length dependence of PSCBE2          | V                              | 0            |
| LPVAG                | Length dependence of PVAG            | m                              | 0            |
| LRDSW                | Length dependence of RDSW            | $\Omega - \mu\text{m}$ -<br>m  | 0            |
| LUA                  | Length dependence of UA              | m <sup>2</sup> /V              | 0            |
| LUB                  | Length dependence of UB              | m <sup>3</sup> /V <sup>2</sup> | 0            |
| LUC                  | Length dependence of UC              | m <sup>2</sup> /V <sup>2</sup> | 0            |
| LVBM                 | Length dependence of VBM             | Vm                             | 0            |
| LVFB                 | Length dependence of VFB             | Vm                             | 0            |
| LVOFF                | Length dependence of VOFF            | Vm                             | 0            |
| LVSAT                | Length dependence of VSAT            | m <sup>2</sup> /s              | 0            |
| LVTH0                | Length dependence of VTH0            | Vm                             | 0            |
| LW0                  | Length dependence of W0              | m <sup>2</sup>                 | 0            |
| LWR                  | Length dependence of WR              | m                              | 0            |
| NFACTOR              | Subthreshold swing factor            | –                              | 1            |
| NGATE                | Poly gate doping concentration       | cm <sup>-3</sup>               | 0            |
| NLX                  | Lateral non-uniform doping parameter | m                              | 1.74e-<br>07 |
| PA0                  | Cross-term dependence of A0          | m <sup>2</sup>                 | 0            |
| PA1                  | Cross-term dependence of A1          | m <sup>2</sup> /V              | 0            |
| PA2                  | Cross-term dependence of A2          | m <sup>2</sup>                 | 0            |
| PAGS                 | Cross-term dependence of AGS         | m <sup>2</sup> /V              | 0            |

| Level=9<br>Parameter | Description   | Units         | Default |
|----------------------|---|---------------|---------|
| PALPHA0              | Cross-term dependence of ALPHA0                           | $m^3/V$       | 0       |
| PALPHA1              | Cross-term dependence of ALPHA1                           | $m^2/V$       | 0       |
| PB0                  | Cross-term dependence of B0                               | $m^3$         | 0       |
| PB1                  | Cross-term dependence of B1                               | $m^3$         | 0       |
| PBETA0               | Cross-term dependence of BETA0                            | $Vm^2$        | 0       |
| PCDSC                | Cross-term dependence of CDSC                             | F             | 0       |
| PCDSCB               | Cross-term dependence of CDSCB                            | F/V           | 0       |
| PCDSCD               | Cross-term dependence of CDSCD                            | F/V           | 0       |
| PCIT                 | Cross-term dependence of CIT                              | F             | 0       |
| PCLM                 | Channel length modulation parameter                       | –             | 1.3     |
| PDELTA               | Cross-term dependence of DELTA                            | $Vm^2$        | 0       |
| PDIBLC1              | First output resistance DIBL effect correction parameter  | –             | 0.39    |
| PDIBLC2              | Second output resistance DIBL effect correction parameter | –             | 0.0086  |
| PDIBLCB              | Body effect coefficient of DIBL correction parameter      | $V^{-1}$      | 0       |
| PDR0UT               | Cross-term dependence of DROUT                            | $m^2$         | 0       |
| PDSUB                | Cross-term dependence of DSUB                             | $m^2$         | 0       |
| PDVT0                | Cross-term dependence of DVT0                             | $m^2$         | 0       |
| PDVT0W               | Cross-term dependence of DVT0W                            | m             | 0       |
| PDVT1                | Cross-term dependence of DVT1                             | $m^2$         | 0       |
| PDVT1W               | Cross-term dependence of DVT1W                            | m             | 0       |
| PDVT2                | Cross-term dependence of DVT2                             | $m^2/V$       | 0       |
| PDVT2W               | Cross-term dependence of DVT2W                            | $m^2/V$       | 0       |
| PDWB                 | Cross-term dependence of DWB                              | $m^3/V^{1/2}$ | 0       |
| PDWG                 | Cross-term dependence of DWG                              | $m^3/V^{1/2}$ | 0       |
| PETA0                | Cross-term dependence of ETA0                             | $m^2$         | 0       |
| PETAB                | Cross-term dependence of ETAB                             | $m^2/V$       | 0       |
| PK1                  | Cross-term dependence of K1                               | $V^{1/2}m^2$  | 0       |
| PK2                  | Cross-term dependence of K2                               | $m^2$         | 0       |
| PK3                  | Cross-term dependence of K3                               | $m^2$         | 0       |

| Level=9<br>Parameter | Description                                    | Units                               | Default  |
|----------------------|--|-------------------------------------|----------|
| PK3B                 | Cross-term dependence of K3B                   | m <sup>2</sup> /V                   | 0        |
| PKETA                | Cross-term dependence of KETA                  | m <sup>2</sup> /V                   | 0        |
| PNFACTOR             | Cross-term dependence of NFACTOR               | m <sup>2</sup>                      | 0        |
| PNGATE               | Cross-term dependence of NGATE                 | m <sup>2</sup> /cm <sup>3</sup>     | 0        |
| PNLX                 | Cross-term dependence of NLX                   | m <sup>3</sup>                      | 0        |
| PPCLM                | Cross-term dependence of PCLM                  | m <sup>2</sup>                      | 0        |
| PPDIBLC1             | Cross-term dependence of PDIBLC1               | m <sup>2</sup>                      | 0        |
| PPDIBLC2             | Cross-term dependence of PDIBLC2               | m <sup>2</sup>                      | 0        |
| PPDIBLCB             | Cross-term dependence of PDIBLCB               | m <sup>2</sup> /V                   | 0        |
| PPRWB                | Cross-term dependence of PRWB                  | m <sup>2</sup> /V <sup>1/2</sup>    | 0        |
| PPRWG                | Cross-term dependence of PRWG                  | m <sup>2</sup> /V                   | 0        |
| PPSCBE1              | Cross-term dependence of PSCBE1                | Vm                                  | 0        |
| PPSCBE2              | Cross-term dependence of PSCBE2                | Vm                                  | 0        |
| PPVAG                | Cross-term dependence of PVAG                  | m <sup>2</sup>                      | 0        |
| PRDSW                | Cross-term dependence of RDSW                  | $\Omega - \mu\text{m} - \text{m}^2$ | 0        |
| PRWB                 | Body effect coefficient of RDSW                | V <sup>-1/2</sup>                   | 0        |
| PRWG                 | Gate-bias effect coefficient of RDSW           | V <sup>-1</sup>                     | 0        |
| PSCBE1               | First substrate current body effect parameter  | V/m                                 | 4.24e+08 |
| PSCBE2               | second substrate current body effect parameter | V/m                                 | 1e-05    |
| PUA                  | Cross-term dependence of UA                    | m <sup>3</sup> /V                   | 0        |
| PUB                  | Cross-term dependence of UB                    | m <sup>4</sup> /V <sup>2</sup>      | 0        |
| PUC                  | Cross-term dependence of UC                    | m <sup>3</sup> /V <sup>2</sup>      | 0        |
| PVAG                 | Gate dependence of early voltage               | -                                   | 0        |
| PVBM                 | Cross-term dependence of VBM                   | Vm <sup>2</sup>                     | 0        |
| PVFB                 | Cross-term dependence of VFB                   | Vm <sup>2</sup>                     | 0        |
| PVOFF                | Cross-term dependence of VOFF                  | Vm <sup>2</sup>                     | 0        |
| PVSAT                | Cross-term dependence of VSAT                  | m <sup>3</sup> /s                   | 0        |
| PVTH0                | Cross-term dependence of VTH0                  | Vm <sup>2</sup>                     | 0        |
| PW0                  | Cross-term dependence of W0                    | m <sup>3</sup>                      | 0        |

| Level=9<br>Parameter | Description  | Units                          | Default   |
|----------------------|--|--------------------------------|-----------|
| PWR                  | Cross-term dependence of WR                                | m <sup>2</sup>                 | 0         |
| RDSW                 | Parasitic resistance per unit width                        | $\Omega - \mu\text{m}$         | 0         |
| UA                   | First-order mobility degradation coefficient               | m/V                            | 2.25e-09  |
| UB                   | First-order mobility degradation coefficient               | m <sup>2</sup> /V <sup>2</sup> | 5.87e-19  |
| UC                   | Body effect of mobility degradation coefficient            | m/V <sup>2</sup>               | -4.65e-11 |
| VBM                  | Maximum applied body-bias in threshold voltage calculation | V                              | -3        |
| VFB                  | Flat-band voltage  | V                              | 0         |
| VOFF                 | Offset voltage in the subthreshold region at large W and L | V                              | -0.08     |
| VSAT                 | Saturation velocity at temp = TNOM                         | m/s                            | 80000     |
| VTH0                 | Threshold voltage at Vbs = 0 for large L                   | V                              | 0.7       |
| W0                   | Narrow-width parameter                                     | m                              | 2.5e-06   |
| WA0                  | Width dependence of A0                                     | m                              | 0         |
| WA1                  | Width dependence of A1                                     | m/V                            | 0         |
| WA2                  | Width dependence of A2                                     | m                              | 0         |
| WAGS                 | Width dependence of AGS                                    | m/V                            | 0         |
| WALPHA0              | Width dependence of ALPHA0                                 | m <sup>2</sup> /V              | 0         |
| WALPHA1              | Width dependence of ALPHA1                                 | m/V                            | 0         |
| WB0                  | Width dependence of B0                                     | m <sup>2</sup>                 | 0         |
| WB1                  | Width dependence of B1                                     | m <sup>2</sup>                 | 0         |
| WBETA0               | Width dependence of BETA0                                  | Vm                             | 0         |
| WCDSC                | Width dependence of CDSC                                   | F/m                            | 0         |
| WCDSCB               | Width dependence of CDSCB                                  | F/(Vm)                         | 0         |
| WCDSCD               | Width dependence of CDSCD                                  | F/(Vm)                         | 0         |
| WCIT                 | Width dependence of CIT                                    | F/m                            | 0         |
| WDELTA               | Width dependence of DELTA                                  | Vm                             | 0         |
| WDROUT               | Width dependence of DROUT                                  | m                              | 0         |

| Level=9<br>Parameter | Description  | Units                            | Default |
|----------------------|--|----------------------------------|---------|
| WDSUB                | Width dependence of DSUB                             | m                                | 0       |
| WDVT0                | Width dependence of DVT0                             | m                                | 0       |
| WDVT0W               | Width dependence of DVT0W                            | –                                | 0       |
| WDVT1                | Width dependence of DVT1                             | m                                | 0       |
| WDVT1W               | Width dependence of DVT1W                            | –                                | 0       |
| WDVT2                | Width dependence of DVT2                             | m/V                              | 0       |
| WDVT2W               | Width dependence of DVT2W                            | m/V                              | 0       |
| WDWB                 | Width dependence of DWB                              | m <sup>2</sup> /V <sup>1/2</sup> | 0       |
| WDWG                 | Width dependence of DWG                              | m <sup>2</sup> /V <sup>1/2</sup> | 0       |
| WETA0                | Width dependence of ETA0                             | m                                | 0       |
| WETAB                | Width dependence of ETAB                             | m/V                              | 0       |
| WINT                 | Width-offset fitting parameter from I-V without bias | m                                | 0       |
| WK1                  | Width dependence of K1                               | V <sup>1/2</sup> m               | 0       |
| WK2                  | Width dependence of K2                               | m                                | 0       |
| WK3                  | Width dependence of K3                               | m                                | 0       |
| WK3B                 | Width dependence of K3B                              | m/V                              | 0       |
| WKETA                | Width dependence of KETA                             | m/V                              | 0       |
| WNFACTOR             | Width dependence of NFACTOR                          | m                                | 0       |
| WNGATE               | Width dependence of NGATE                            | m/cm <sup>3</sup>                | 0       |
| WNLX                 | Width dependence of NLX                              | m <sup>2</sup>                   | 0       |
| WPCLM                | Width dependence of PCLM                             | m                                | 0       |
| WPDIBLC1             | Width dependence of PDIBLC1                          | m                                | 0       |
| WPDIBLC2             | Width dependence of PDIBLC2                          | m                                | 0       |
| WPDIBLCB             | Width dependence of PDIBLCB                          | m/V                              | 0       |
| WPRWB                | Width dependence of PRWB                             | m/V <sup>1/2</sup>               | 0       |
| WPRWG                | Width dependence of PRWG                             | m/V                              | 0       |
| WPSCBE1              | Width dependence of PSCBE1                           | V                                | 0       |
| WPSCBE2              | Width dependence of PSCBE2                           | V                                | 0       |
| WPVAG                | Width dependence of PVAG                             | m                                | 0       |

| Level=9<br>Parameter              | Description                                | Units                    | Default  |
|-----------------------------------|--|--------------------------|----------|
| WR                                | Width offset from Weff for Rds Calculation | –                        | 1        |
| WRDSW                             | Width dependence of RDSW                   | $\Omega - \mu\text{m-m}$ | 0        |
| WUA                               | Width dependence of UA                     | $\text{m}^2/\text{V}$    | 0        |
| WUB                               | Width dependence of UB                     | $\text{m}^3/\text{V}^2$  | 0        |
| WUC                               | Width dependence of UC                     | $\text{m}^2/\text{V}^2$  | 0        |
| WVBM                              | Width dependence of VBM                    | Vm                       | 0        |
| WVFB                              | Width dependence of VFB                    | Vm                       | 0        |
| WVOFF                             | Width dependence of VOFF                   | Vm                       | 0        |
| WVSAT                             | Width dependence of VSAT                   | $\text{m}^2/\text{s}$    | 0        |
| WVTHO                             | Width dependence of VTH0                   | Vm                       | 0        |
| WVO                               | Width dependence of W0                     | $\text{m}^2$             | 0        |
| WWR                               | Width dependence of WR                     | m                        | 0        |
| <b><i>Doping Parameters</i></b>   |  |                          |          |
| LNSUB                             | Length dependence of NSUB                  | $\text{m}/\text{cm}^3$   | 0        |
| MJ                                | Bulk p-n bottom grading coefficient        | –                        | 0.5      |
| MJSW                              | Bulk p-n sidewall grading coefficient      | –                        | 0.33     |
| NSUB                              | Substrate doping density                   | $\text{cm}^{-3}$         | 6e+16    |
| PNSUB                             | Cross-term dependence of NSUB              | $\text{m}^2/\text{cm}^3$ | 0        |
| WNSUB                             | Width dependence of NSUB                   | $\text{m}/\text{cm}^3$   | 0        |
| <b><i>Flicker Parameters</i></b>  |  |                          |          |
| AF                                | Flicker noise exponent                     | –                        | 1        |
| EF                                | Flicker exponent                           | –                        | 1        |
| EM                                | Saturation field                           | V/m                      | 4.1e+07  |
| KF                                | Flicker noise coefficient                  | –                        | 0        |
| NOIA                              | Noise parameter a                          | –                        | 1e+20    |
| NOIB                              | Noise parameter b                          | –                        | 50000    |
| NOIC                              | Noise parameter c                          | –                        | -1.4e-12 |
| <b><i>Geometry Parameters</i></b> |  |                          |          |
| L                                 | Default channel length                     | m                        | 5e-06    |

| Level=9<br>Parameter         | Description   | Units         | Default |
|------------------------------|---|---------------|---------|
| LL                           | Coefficient of length dependence for length offset                      | $m^{LLN}$     | 0       |
| LLC                          | Coefficient of length dependence for CV channel length offset           | $m^{LLN}$     | 0       |
| LLN                          | Power of length dependence for length offset                            | –             | 0       |
| LW                           | Coefficient of width dependence for length offset                       | $m^{LWN}$     | 0       |
| LWC                          | Coefficient of width dependence for channel length offset               | $m^{LWN}$     | 0       |
| LWL                          | Coefficient of length and width cross term for length offset            | $m^{LLN+LWN}$ | 0       |
| LWLC                         | Coefficient of length and width dependence for CV channel length offset | $m^{LLN+LWN}$ | 0       |
| LWN                          | Power of width dependence for length offset                             | –             | 0       |
| LXJ                          | Length dependence of XJ   | $m^2$         | 0       |
| PXJ                          | Cross-term dependence of XJ   | $m^3$         | 0       |
| TOX                          | Gate oxide thickness  | m             | 1.5e-08 |
| W                            | Default channel width   | m             | 5e-06   |
| WL                           | Coefficient of length dependence for width offset                       | $m^{WLN}$     | 0       |
| WLC                          | Coefficient of length dependence for CV channel width offset            | $m^{WLN}$     | 0       |
| WLN                          | Power of length dependence of width offset                              | –             | 0       |
| WW                           | Coefficient of width dependence for width offset                        | $m^{WWN}$     | 0       |
| WWC                          | Coefficient of width dependence for CV channel width offset             | $m^{WWN}$     | 0       |
| WWL                          | Coefficient of length and width cross term for width offset             | $m^{WLN+WWN}$ | 0       |
| WWLC                         | Coefficient of length and width dependence for CV channel width offset  | $m^{WLN+WWN}$ | 0       |
| WWN                          | Power of width dependence of width offset                               | –             | 0       |
| WXJ                          | Width dependence of XJ  | $m^2$         | 0       |
| XJ                           | Junction depth  | m             | 1.5e-07 |
| <b><i>NQS Parameters</i></b> |   |               |         |
| ELM                          | Elmore constant of the channel  | –             | 5       |
| LELM                         | Length dependence of ELM  | m             | 0       |

| Level=9<br>Parameter         | Description                              | Units                                | Default |
|------------------------------|--|--------------------------------------|---------|
| PELM                         | Cross-term dependence of ELM             | m <sup>2</sup>                       | 0       |
| WELM                         | Width dependence of ELM                  | m                                    | 0       |
| <b>Resistance Parameters</b> |  |                                      |         |
| RSH                          | Drain, source diffusion sheet resistance | Ω                                    | 0       |
| <b>Process Parameters</b>    |  |                                      |         |
| GAMMA1                       | Body effect coefficient near the surface | V <sup>1/2</sup>                     | 0       |
| GAMMA2                       | Body effect coefficient in the bulk      | V <sup>1/2</sup>                     | 0       |
| JS                           | Bulk p-n saturation current density      | A/m <sup>2</sup>                     | 0.0001  |
| LGAMMA1                      | Length dependence of GAMMA1              | V <sup>1/2</sup> m                   | 0       |
| LGAMMA2                      | Length dependence of GAMMA2              | V <sup>1/2</sup> m                   | 0       |
| LNCH                         | Length dependence of NCH                 | m/cm <sup>3</sup>                    | 0       |
| LU0                          | Length dependence of U0                  | m/(Vcm <sup>2</sup> s)               | 0       |
| LVBX                         | Length dependence of VBX                 | Vm                                   | 0       |
| LXT                          | Length dependence of XT                  | m <sup>2</sup>                       | 0       |
| NCH                          | Channel doping concentration             | cm <sup>-3</sup>                     | 1.7e+17 |
| PGAMMA1                      | Cross-term dependence of GAMMA1          | V <sup>1/2</sup> m <sup>2</sup>      | 0       |
| PGAMMA2                      | Cross-term dependence of GAMMA2          | V <sup>1/2</sup> m <sup>2</sup>      | 0       |
| PNCH                         | Cross-term dependence of NCH             | m <sup>2</sup> /cm <sup>3</sup>      | 0       |
| PU0                          | Cross-term dependence of U0              | m <sup>2</sup> /(Vcm <sup>2</sup> s) | 0       |
| PVBX                         | Cross-term dependence of VBX             | Vm <sup>2</sup>                      | 0       |
| PXT                          | Cross-term dependence of XT              | m <sup>3</sup>                       | 0       |
| TOXM                         | Gate oxide thickness used in extraction  | m                                    | 1.5e-08 |
| U0                           | Surface mobility                         | 1/(Vcm <sup>2</sup> s)               | 0.067   |
| VBX                          | Vbs at which the depletion region = XT   | V                                    | 0       |
| WGAMMA1                      | Width dependence of GAMMA1               | V <sup>1/2</sup> m                   | 0       |
| WGAMMA2                      | Width dependence of GAMMA2               | V <sup>1/2</sup> m                   | 0       |
| WNCH                         | Width dependence of NCH                  | m/cm <sup>3</sup>                    | 0       |
| WU0                          | Width dependence of U0                   | m/(Vcm <sup>2</sup> s)               | 0       |
| WVBX                         | Width dependence of VBX                  | Vm                                   | 0       |
| WXT                          | Width dependence of XT                   | m <sup>2</sup>                       | 0       |



| Level=9<br>Parameter          | Description  | Units                               | Default  |
|-------------------------------|--|-------------------------------------|----------|
| XT                            | Doping depth   | m                                   | 1.55e-07 |
| <b>Temperature Parameters</b> |  |                                     |          |
| AT                            | Temperature coefficient for saturation velocity                                    | m/s                                 | 33000    |
| KT1                           | Temperature coefficient for threshold voltage                                      | V                                   | -0.11    |
| KT1L                          | Channel length dependence of the temperature coefficient for the threshold voltage | Vm                                  | 0        |
| KT2                           | Body-bias coefficient fo the threshold voltage temperature effect                  | –                                   | 0.022    |
| LAT                           | Length dependence of AT  | m <sup>2</sup> /s                   | 0        |
| LKT1                          | Length dependence of KT1   | Vm                                  | 0        |
| LKT1L                         | Length dependence of KT1L  | Vm <sup>2</sup>                     | 0        |
| LKT2                          | Length dependence of KT2   | m                                   | 0        |
| LPRT                          | Length dependence of PRT   | $\Omega - \mu\text{m}-\text{m}$     | 0        |
| LUA1                          | Length dependence of UA1   | m <sup>2</sup> /V                   | 0        |
| LUB1                          | Length dependence of UB1   | m <sup>3</sup> /V <sup>2</sup>      | 0        |
| LUC1                          | Length dependence of UC1   | m <sup>2</sup> /(°CV <sup>2</sup> ) | 0        |
| LUTE                          | Length dependence of UTE   | m                                   | 0        |
| NJ                            | Emission coefficient of junction   | –                                   | 1        |
| PAT                           | Cross-term dependence of AT  | m <sup>3</sup> /s                   | 0        |
| PKT1                          | Cross-term dependence of KT1   | Vm <sup>2</sup>                     | 0        |
| PKT1L                         | Cross-term dependence of KT1L  | Vm <sup>3</sup>                     | 0        |
| PKT2                          | Cross-term dependence of KT2   | m <sup>2</sup>                      | 0        |
| PPRT                          | Cross-term dependence of PRT   | $\Omega - \mu\text{m}-\text{m}^2$   | 0        |
| PRT                           | Temerature coefficient for RDSW  | $\Omega - \mu\text{m}$              | 0        |
| PUA1                          | Cross-term dependence of UA1   | m <sup>3</sup> /V                   | 0        |
| PUB1                          | Cross-term dependence of UB1   | m <sup>4</sup> /V <sup>2</sup>      | 0        |
| PUC1                          | Cross-term dependence of UC1   | m <sup>3</sup> /(°CV <sup>2</sup> ) | 0        |
| PUTE                          | Cross-term dependence of UTE   | m <sup>2</sup>                      | 0        |

| Level=9<br>Parameter             | Description                                       | Units                               | Default   |
|----------------------------------|---|-------------------------------------|-----------|
| TCJ                              | Temperature coefficient of Cj                     | °K <sup>-1</sup>                    | 0         |
| TCJSW                            | Temperature coefficient of Cswj                   | °K <sup>-1</sup>                    | 0         |
| TCJSWG                           | Temperature coefficient of Cjswg                  | °K <sup>-1</sup>                    | 0         |
| TNOM                             | Nominal device temperature                        | °C                                  | 27        |
| TPB                              | Temperature coefficient of Pb                     | V/K                                 | 0         |
| TPBSW                            | Temperature coefficient of Pbsw                   | V/K                                 | 0         |
| TPBSWG                           | Temperature coefficient of Pbswg                  | V/K                                 | 0         |
| UA1                              | Temperature coefficient for UA                    | m/V                                 | 4.31e-09  |
| UB1                              | Temperature coefficient for UB                    | m <sup>2</sup> /V <sup>2</sup>      | -7.61e-18 |
| UC1                              | Temperature coefficient for UC                    | m/(°CV <sup>2</sup> )               | -5.6e-11  |
| UTE                              | Mobility temperature exponent                     | –                                   | -1.5      |
| WAT                              | Width dependence of AT                            | m <sup>2</sup> /s                   | 0         |
| WKT1                             | Width dependence of KT1                           | Vm                                  | 0         |
| WKT1L                            | Width dependence of KT1L                          | Vm <sup>2</sup>                     | 0         |
| WKT2                             | Width dependence of KT2                           | m                                   | 0         |
| WPRT                             | Width dependence of PRT                           | Ω – μm-m                            | 0         |
| WUA1                             | Width dependence of UA1                           | m <sup>2</sup> /V                   | 0         |
| WUB1                             | Width dependence of UB1                           | m <sup>3</sup> /V <sup>2</sup>      | 0         |
| WUC1                             | Width dependence of UC1                           | m <sup>2</sup> /(°CV <sup>2</sup> ) | 0         |
| WUTE                             | Width dependence of UTE                           | m                                   | 0         |
| XTI                              | Junction current temperature exponent coefficient | –                                   | 3         |
| <b><i>Voltage Parameters</i></b> |   |                                     |           |
| PB                               | Bulk p-n bottom potential                         | V                                   | 1         |

Table 2.30: BSIM3 Device Model Parameters.

| Level=10<br>Parameter        | Description   | Units          | Default |
|------------------------------|---|----------------|---------|
| DELTAVOX                     | The smoothing parameter in the Vox smoothing function       | –              | 0.005   |
| DTOXCV                       | Delta oxide thickness in meters in CapMod3                  | m              | 0       |
| FNOIMOD                      | Flicker noise model selector                                | –              | 1       |
| IGBMOD                       | Flicker noise model selector                                | –              | 0       |
| IGCMOD                       | Gate-channel tunneling current model selector               | –              | 0       |
| KB1                          | Scaling factor for backgate charge                          | –              | 1       |
| LKB1                         | Length dependence of KB1                                    | m              | 0       |
| LPOXEDGE                     | Length dependence of POXEDGE                                | m              | 0       |
| NOIF                         | Floating body excess noise ideality factor                  | –              | 1       |
| NTNOI                        | Thermal noise parameter                                     | –              | 1       |
| PKB1                         | Cross-term dependence of KB1                                | m <sup>2</sup> | 0       |
| POXEDGE                      | Factor for the gate edge Tox                                | –              | 1       |
| PPOXEDGE                     | Cross-term dependence of POXEDGE                            | m <sup>2</sup> | 0       |
| RNOIA                        | Thermal noise coefficient                                   | –              | 0.577   |
| RNOIB                        | Thermal noise coefficient                                   | –              | 0.37    |
| RSHG                         | Gate sheet resistance                                       | –              | 0.1     |
| TNOIA                        | Thermal noise parameter                                     | –              | 1.5     |
| TNOIB                        | Thermal noise parameter                                     | –              | 3.5     |
| TNOIMOD                      | Thermal noise model selector                                | –              | 0       |
| VBSOFD                       | Lower bound of built-in potential lowering for FD operation | V              | 0.5     |
| VBSOPD                       | Upper bound of built-in potential lowering for FD operation | –              | 0       |
| VOXH                         | The limit of Vox in gate current calculation                | –              | 5       |
| VTH0                         | Threshold voltage   | –              | 0.7     |
| WKB1                         | Width dependence of KB1                                     | m              | 0       |
| WPOXEDGE                     | Width dependence of POXEDGE                                 | m              | 0       |
| <b><i>Bin Parameters</i></b> |   |                |         |
| LMAX                         | Maximum channel length                                      | m              | 1       |
| LMIN                         | Minimum channel length                                      | m              | 0       |

| Level=10<br>Parameter         | Description   | Units             | Default     |
|-------------------------------|---|-------------------|-------------|
| WMAX                          | Maximum channel width   | m                 | 1           |
| WMIN                          | Minimum channel width   | m                 | 0           |
| <b>Capacitance Parameters</b> |   |                   |             |
| ACDE                          | Exponential coefficient for charge thickness in capmod = 3 for accumulation and depletion regions | m/V               | 1           |
| ASD                           | Source/Drain bottom diffusion smoothing parameter   | –                 | 0.3         |
| CF                            | Firing field capacitance  | F/m               | 8.16367e-11 |
| CGDL                          | Light-doped drain-gate region overlap capacitance   | F/m               | 0           |
| CGDO                          | Non-LLD region drain-gate overlap capacitance per unit channel length                             | F/m               | 0           |
| CGEO                          | Gate substrate overlap capacitance per unit channel length  | F/m               | 0           |
| CGSL                          | Light-doped source-gate region overlap capacitance  | F/m               | 0           |
| CGSO                          | Non-LLD region source-gate overlap capacitance per unit channel length                            | F/m               | 0           |
| CJSWG                         | Source/Drain gate sidewall junction capacitance per unit width                                    | F/m               | 1e-10       |
| CKAPPA                        | Coefficient for lightly doped region overlap capacitance firing field capacitance                 | F/m               | 0.6         |
| CLC                           | Constant term for short-channel model   | m                 | 1e-08       |
| CLE                           | Exponential term for the short-channel model  | –                 | 0           |
| CSDESW                        | Source/Drain sidewall fringing capacitance per unit length  | F/m               | 0           |
| CSDMIN                        | Source/Drain bottom diffusion minimum capacitance   | V                 | 0.000100544 |
| DELVT                         | Threshold voltage adjust for C-V  | V                 | 0           |
| DLBG                          | Length offset fitting parameter for backgate charge   | m                 | 0           |
| DLC                           | Length offset fitting parameter from C-V  | m                 | 0           |
| DLCB                          | Length offset fitting parameter for body charge   | m                 | 0           |
| DWC                           | Width offset fitting parameter from C-V   | m                 | 0           |
| FBODY                         | Scaling factor for body charge  | –                 | 1           |
| LACDE                         | Length dependence of ACDE   | m <sup>2</sup> /V | 0           |

| Level=10<br>Parameter | Description  | Units             | Default |
|-----------------------|--|-------------------|---------|
| LCGDL                 | Length dependence of CGDL  | F                 | 0       |
| LCGSL                 | Length dependence of CGSL  | F                 | 0       |
| LCKAPPA               | Length dependence of CKAPPA  | F                 | 0       |
| LDELVT                | Length dependence of DELVT   | Vm                | 0       |
| LDIFO                 | Channel length dependency coefficient of diffusion capacitance           | –                 | 1       |
| LMOIN                 | Length dependence of MOIN  | m                 | 0       |
| LNDIF                 | Length dependence of NDIF  | m                 | 0       |
| LNOFF                 | Length dependence of NOFF  | m                 | 0       |
| LVSDFB                | Length dependence of VSDFB   | Vm                | 0       |
| LVSDTH                | Length dependence of VSDTH   | Vm                | 0       |
| MJSWG                 | Source/Drain gate sidewall junction capacitance grading coefficient      | –                 | 0.5     |
| MOIN                  | Coefficient for the gate-bias dependent surface potential                | –                 | 15      |
| NDIF                  | Power coefficient of channel length dependency for diffusion capacitance | –                 | -1      |
| NOFF                  | CV parameter in Vgsteff, CV for weak to strong inversion                 | –                 | 1       |
| PACDE                 | Cross-term dependence of ACDE  | m <sup>3</sup> /V | 0       |
| PBSWG                 | Source/drain gate sidewall junction built-in potential                   | V                 | 0.7     |
| PCGDL                 | Cross-term dependence of CGDL  | Fm                | 0       |
| PCGSL                 | Cross-term dependence of CGSL  | Fm                | 0       |
| PCKAPPA               | Cross-term dependence of CKAPPA  | Fm                | 0       |
| PDELVT                | Cross-term dependence of DELVT   | Vm <sup>2</sup>   | 0       |
| PMOIN                 | Cross-term dependence of MOIN  | m <sup>2</sup>    | 0       |
| PNDIF                 | Cross-term dependence of NDIF  | m <sup>2</sup>    | 0       |
| PNOFF                 | Cross-term dependence of NOFF  | m <sup>2</sup>    | 0       |
| PVSDFB                | Cross-term dependence of VSDFB   | Vm <sup>2</sup>   | 0       |
| PVSDTH                | Cross-term dependence of VSDTH   | Vm <sup>2</sup>   | 0       |
| TT                    | Diffusion capacitance transit time coefficient                           | s                 | 1e-12   |
| VSDFB                 | Source/Drain bottom diffusion capacitance flatband voltage               | V                 | 0       |

| Level=10<br>Parameter     | Description   | Units                    | Default |
|---------------------------|---|--------------------------|---------|
| VSDTH                     | Source/Drain bottom diffusion capacitance threshold voltage                                   | V                        | 0       |
| WACDE                     | Width dependence of ACDE  | m <sup>2</sup> /V        | 0       |
| WCGDL                     | Width dependence of CGDL  | F                        | 0       |
| WCGSL                     | Width dependence of CGSL  | F                        | 0       |
| WCKAPPA                   | Width dependence of CKAPPA  | F                        | 0       |
| WDELVT                    | Width dependence of DELVT   | Vm                       | 0       |
| WMOIN                     | Width dependence of MOIN  | m                        | 0       |
| WNDIF                     | Width dependence of NDIF  | m                        | 0       |
| WNOFF                     | Width dependence of NOFF  | m                        | 0       |
| WVSDFB                    | Width dependence of VSDFB   | Vm                       | 0       |
| WVSDTH                    | Width dependence of VSDTH   | Vm                       | 0       |
| XPART                     | Charge partitioning rate flag   | –                        | 0       |
| <b>Control Parameters</b> |   |                          |         |
| BINUNIT                   | Binning unit selector   | –                        | 1       |
| CAPMOD                    | Flag for capacitance models   | –                        | 2       |
| MOBMOD                    | Mobility model selector   | –                        | 1       |
| PARAMCHK                  | Parameter value check   | –                        | 0       |
| SHMOD                     | Flag for self-heating, 0-no self-heating, 1-self-heating                                      | –                        | 0       |
| TEMPMODEL                 | Specification to type of parameter interpolation over temperature (see User Guide section 5.3 | –                        | NONE    |
| VERSION                   | Version number  | –                        | 3.2     |
| <b>Current Parameters</b> |   |                          |         |
| AIGC                      | Parameter for Igc   | (F/g) <sup>1/2</sup> s/m | 0.43    |
| AIGSD                     | Parameter for Igs,d   | (F/g) <sup>1/2</sup> s/m | 0.43    |
| BIGC                      | Parameter for Igc   | (F/g) <sup>1/2</sup> s/m | 0.054   |
| BIGSD                     | Parameter for Igs,d   | (F/g) <sup>1/2</sup> s/m | 0.054   |
| CIGC                      | Parameter for Igc   | V <sup>-1</sup>          | 0.075   |
| CIGSD                     | Parameter for Igs,d   | V <sup>-1</sup>          | 0.075   |
| DLICG                     | Delta L for Ig model  | V <sup>-1</sup>          | 0       |

| Level=10<br>Parameter | Description                                       | Units                               | Default |
|-----------------------|---|-------------------------------------|---------|
| LAIGC                 | Length dependence of AIGC                         | $(F/g)^{1/2} \text{sm}/\text{mV}$   | 0       |
| LAIGSD                | Length dependence of AIGSD                        | $(F/g)^{1/2} \text{sm}/\text{mV}$   | 0       |
| LBIGC                 | Length dependence of BIGC                         | $(F/g)^{1/2} \text{sm}/\text{mV}$   | 0       |
| LBIGSD                | Length dependence of BIGSD                        | $(F/g)^{1/2} \text{sm}/\text{mV}$   | 0       |
| LCIGC                 | Length dependence of CIGC                         | m/V                                 | 0       |
| LCIGSD                | Length dependence of CIGSD                        | m/V                                 | 0       |
| LNIGC                 | Length dependence of NIGC                         | m                                   | 0       |
| LPIGCD                | Length dependence of PIGCD                        | m                                   | 0       |
| NIGC                  | Parameter for $I_{gc}$ slope                      | –                                   | 1       |
| PAIGC                 | Cross-term dependence of AIGC                     | $(F/g)^{1/2} \text{sm}^2/\text{mV}$ | 0       |
| PAIGSD                | Cross-term dependence of AIGSD                    | $(F/g)^{1/2} \text{sm}^2/\text{mV}$ | 0       |
| PBIGC                 | Cross-term dependence of BIGC                     | $(F/g)^{1/2} \text{sm}^2/\text{mV}$ | 0       |
| PBIGSD                | Cross-term dependence of BIGSD                    | $(F/g)^{1/2} \text{sm}^2/\text{mV}$ | 0       |
| PCIGC                 | Cross-term dependence of CIGC                     | $\text{m}^2/\text{V}$               | 0       |
| PCIGSD                | Cross-term dependence of CIGSD                    | $\text{m}^2/\text{V}$               | 0       |
| PIGCD                 | Parameter for $I_{gc}$ partition                  | –                                   | 1       |
| PNIGC                 | Cross-term dependence of NIGC                     | $\text{m}^2$                        | 0       |
| PPIGCD                | Cross-term dependence of PIGCD                    | $\text{m}^2$                        | 0       |
| WAIGC                 | Width dependence of AIGC                          | $(F/g)^{1/2} \text{sm}/\text{mV}$   | 0       |
| WAIGSD                | Width dependence of AIGSD                         | $(F/g)^{1/2} \text{sm}/\text{mV}$   | 0       |
| WBIGC                 | Width dependence of BIGC                          | $(F/g)^{1/2} \text{sm}/\text{mV}$   | 0       |
| WBIGSD                | Width dependence of BIGSD                         | $(F/g)^{1/2} \text{sm}/\text{mV}$   | 0       |
| WCIGC                 | Width dependence of CIGC                          | m/V                                 | 0       |
| WCIGSD                | Width dependence of CIGSD                         | m/V                                 | 0       |
| WNIGC                 | Width dependence of NIGC                          | m                                   | 0       |
| WPIGCD                | Width dependence of PIGCD                         | m                                   | 0       |
| <b>DC Parameters</b>  |   |                                     |         |
| A0                    | Bulk charge effect coefficient for channel length | –                                   | 1       |
| A1                    | First non-saturation effect parameter             | $\text{V}^{-1}$                     | 0       |

| Level=10<br>Parameter | Description  | Units                | Default |
|-----------------------|--|----------------------|---------|
| A2                    | Second non-saturation factor   | –                    | 1       |
| AELY                  | Chananel length dependency of early voltage for bipolar current                                | V/m                  | 0       |
| AGIDL                 | GIDL constant  | $\Omega^{-1}$        | 0       |
| AGS                   | Gate-bias coefficient of abulk   | $V^{-1}$             | 0       |
| AHLI                  | High level injection parameter for bipolar current   | –                    | 0       |
| ALPHA0                | First parameter of impact-ionization current   | m/V                  | 0       |
| B0                    | Bulk charge effect coefficient for channel width   | m                    | 0       |
| B1                    | Bulk charge effect offset  | m                    | 0       |
| BETA0                 | Second parameter of impact-ionization current  | V                    | 0       |
| BETA1                 | Second Vds dependent parameter of impact ionization current                                    | –                    | 0       |
| BETA2                 | Third Vds dependent parameter of impact ionization current                                     | V                    | 0.1     |
| BGIDL                 | GIDL exponential coefficient   | V/m                  | 0       |
| CDSC                  | Drain/source to channel coupling capacitance   | F/m <sup>2</sup>     | 0.00024 |
| CDSCB                 | Body-bias sensitivity of CDSC  | F/(Vm <sup>2</sup> ) | 0       |
| CDSCD                 | Drain-bias sensitivity of CDSC   | F/(Vm <sup>2</sup> ) | 0       |
| CIT                   | Interface trap capacitance   | F/m <sup>2</sup>     | 0       |
| DELTA                 | Effective Vds parameter  | V                    | 0.01    |
| DROUT                 | L-dependence Coefficient of the DIBL correction parameter in Rout                              | –                    | 0.56    |
| DSUB                  | DIBL coefficient exponent in subthreshold region   | –                    | 0.56    |
| DVTO                  | First coefficient of short-channel effect effect on threshold voltage                          | –                    | 2.2     |
| DVTOW                 | First coefficient of narrow-width effect effect on threshold voltage for small channel length  | m <sup>-1</sup>      | 0       |
| DVT1                  | Second coefficient of short-channel effect effect on threshold voltage                         | –                    | 0.53    |
| DVT1W                 | Second coefficient of narrow-width effect effect on threshold voltage for small channel length | m <sup>-1</sup>      | 5.3e+06 |



| Level=10<br>Parameter | Description   | Units       | Default |
|-----------------------|---|-------------|---------|
| DVT2                  | Body-bias coefficient of short-channel effect effect on threshold voltage                         | $V^{-1}$    | -0.032  |
| DVT2W                 | Body-bias coefficient of narrow-width effect effect on threshold voltage for small channel length | $V^{-1}$    | -0.032  |
| DWB                   | Coefficient of substrate body bias dependence of Weff   | $m/V^{1/2}$ | 0       |
| DWBC                  | Width offset for body contact isolation edge  | m           | 0       |
| DWG                   | Coefficient of gate dependence of Weff  | $m/V^{1/2}$ | 0       |
| ESATII                | Saturation channel electric field for impact ionization current                                   | V/m         | 1e+07   |
| ETA0                  | DIBL coefficient in subthreshold region   | –           | 0.08    |
| ETAB                  | Body-bias coefficient for the subthreshold DIBL effect  | $V^{-1}$    | -0.07   |
| FBJTII                | Fraction of bipolar current affecting the impact ionization                                       | –           | 0       |
| ISBJT                 | BJT injection saturation current  | $A/m^2$     | 1e-06   |
| ISDIF                 | BOdy to source/drain injection saturation current   | $A/m^2$     | 0       |
| ISREC                 | Recombination in depletion saturation current   | $A/m^2$     | 1e-05   |
| ISTUN                 | Reverse tunneling saturation current  | $A/m^2$     | 0       |
| K1                    | First-order body effect coefficient   | $V^{1/2}$   | 0.53    |
| K1W1                  | First body effect width dependent parameter   | m           | 0       |
| K1W2                  | Second body effect width dependent parameter  | m           | 0       |
| K2                    | second-order body effect coefficient  | –           | -0.0186 |
| K3                    | Narrow width coefficient  | –           | 0       |
| K3B                   | Body effect coefficient of K3   | $V^{-1}$    | 0       |
| KETA                  | Body-bias coefficient of bulk charge effect   | $V^{-1}$    | -0.6    |
| KETAS                 | Surface potential adjustment for bulk charge effect   | V           | 0       |
| LA0                   | Length dependence of A0   | m           | 0       |
| LA1                   | Length dependence of A1   | $m/V$       | 0       |
| LA2                   | Length dependence of A2   | m           | 0       |
| LAELY                 | Length dependence of AELY   | V           | 0       |
| LAGIDL                | Length dependence of AGIDL  | $m/\Omega$  | 0       |
| LAGS                  | Length dependence of AGS  | $m/V$       | 0       |

| Level=10<br>Parameter | Description   | Units                            | Default |
|-----------------------|---|----------------------------------|---------|
| LAHLI                 | Length dependence of AHLI   | m                                | 0       |
| LALPHA0               | Length dependence of ALPHA0   | m <sup>2</sup> /V                | 0       |
| LB0                   | Length dependence of B0   | m <sup>2</sup>                   | 0       |
| LB1                   | Length dependence of B1   | m <sup>2</sup>                   | 0       |
| LBETA0                | Length dependence of BETA0  | Vm                               | 0       |
| LBETA1                | Length dependence of BETA1  | m                                | 0       |
| LBETA2                | Length dependence of BETA2  | Vm                               | 0       |
| LBGIDL                | Length dependence of BGIDL  | V                                | 0       |
| LBJT0                 | Reference channel length for bipolar current                                  | m                                | 2e-07   |
| LCDSC                 | Length dependence of CDSC   | F/m                              | 0       |
| LCDSCB                | Length dependence of CDSCB  | F/(Vm)                           | 0       |
| LCDSCD                | Length dependence of CDSCD  | F/(Vm)                           | 0       |
| LCIT                  | Length dependence of CIT  | F/m                              | 0       |
| LDELTA                | Length dependence of DELTA  | Vm                               | 0       |
| LDROUT                | Length dependence of DROUT  | m                                | 0       |
| LDSUB                 | Length dependence of DSUB   | m                                | 0       |
| LDVT0                 | Length dependence of DVT0   | m                                | 0       |
| LDVT0W                | Length dependence of DVT0W  | –                                | 0       |
| LDVT1                 | Length dependence of DVT1   | m                                | 0       |
| LDVT1W                | Length dependence of DVT1W  | –                                | 0       |
| LDVT2                 | Length dependence of DVT2   | m/V                              | 0       |
| LDVT2W                | Length dependence of DVT2W  | m/V                              | 0       |
| LDWB                  | Length dependence of DWB  | m <sup>2</sup> /V <sup>1/2</sup> | 0       |
| LDWG                  | Length dependence of DWG  | m <sup>2</sup> /V <sup>1/2</sup> | 0       |
| LESATII               | Length dependence of ESATII   | V                                | 0       |
| LETA0                 | Length dependence of ETA0   | m                                | 0       |
| LETAB                 | Length dependence of ETAB   | m/V                              | 0       |
| LFBJTII               | Length dependence of FBJTII   | m                                | 0       |
| LII                   | Channel length dependent parameter at threshold for impact ionization current | –                                | 0       |

| Level=10<br>Parameter | Description  | Units      | Default |
|-----------------------|--|------------|---------|
| LINT                  | Length of offset fitting parameter from I-V without bias | m          | 0       |
| LISBJT                | Length dependence of ISBJT                               | A/m        | 0       |
| LISDIF                | Length dependence of ISDIF                               | A/m        | 0       |
| LISREC                | Length dependence of ISREC                               | A/m        | 0       |
| LISTUN                | Length dependence of ISTUN                               | A/m        | 0       |
| LK1                   | Length dependence of K1                                  | $V^{1/2}m$ | 0       |
| LK1W1                 | Length dependence of K1W1                                | $m^2$      | 0       |
| LK1W2                 | Length dependence of K1W2                                | $m^2$      | 0       |
| LK2                   | Length dependence of K2                                  | m          | 0       |
| LK3                   | Length dependence of K3                                  | m          | 0       |
| LK3B                  | Length dependence of K3B                                 | m/V        | 0       |
| LKETA                 | Length dependence of KETA                                | m/V        | 0       |
| LKETAS                | Length dependence of KETAS                               | Vm         | 0       |
| LLBJT0                | Length dependence of LBJT0                               | $m^2$      | 0       |
| LLII                  | Length dependence of LII                                 | m          | 0       |
| LN                    | Electron/hole diffusion length                           | m          | 2e-06   |
| LNBJT                 | Length dependence of NBJT                                | m          | 0       |
| LNDIODE               | Length dependence of NDIODE                              | m          | 0       |
| LNFACTOR              | Length dependence of NFACTOR                             | m          | 0       |
| LNGATE                | Length dependence of NGATE                               | $m/cm^3$   | 0       |
| LNGIDL                | Length dependence of NGIDL                               | Vm         | 0       |
| LNLX                  | Length dependence of NLX                                 | $m^2$      | 0       |
| LNRECF0               | Length dependence of NRECF0                              | m          | 0       |
| LNRECR0               | Length dependence of NRECR0                              | m          | 0       |
| LNTUN                 | Length dependence of NTUN                                | m          | 0       |
| LPCLM                 | Length dependence of PCLM                                | m          | 0       |
| LPDIBLC1              | Length dependence of PDIBLC1                             | m          | 0       |
| LPDIBLC2              | Length dependence of PDIBLC2                             | m          | 0       |
| LPDIBLCB              | Length dependence of PDIBLCB                             | m/V        | 0       |

| Level=10<br>Parameter | Description                                       | Units                | Default  |
|-----------------------|---|----------------------|----------|
| LPRWB                 | Length dependence of PRWB                         | $m/V^{1/2}$          | 0        |
| LPRWG                 | Length dependence of PRWG                         | $m/V$                | 0        |
| LPVAG                 | Length dependence of PVAG                         | m                    | 0        |
| LRDSW                 | Length dependence of RDSW                         | $\Omega - \mu m - m$ | 0        |
| LSII0                 | Length dependence of SII0                         | $m/V$                | 0        |
| LSII1                 | Length dependence of SII1                         | $m/V$                | 0        |
| LSII2                 | Length dependence of SII2                         | m                    | 0        |
| LSIID                 | Length dependence of SIID                         | $m/V$                | 0        |
| LUA                   | Length dependence of UA                           | $m^2/V$              | 0        |
| LUB                   | Length dependence of UB                           | $m^3/V^2$            | 0        |
| LUC                   | Length dependence of UC                           | $m^2/V^2$            | 0        |
| LVABJT                | Length dependence of VABJT                        | Vm                   | 0        |
| LVDSATII0             | Length dependence of VDSATII0                     | Vm                   | 0        |
| LVOFF                 | Length dependence of VOFF                         | Vm                   | 0        |
| LVRECO                | Length dependence of VRECO                        | Vm                   | 0        |
| LVSAT                 | Length dependence of VSAT                         | $m^2/s$              | 0        |
| LVTH0                 | Length dependence of VTH0                         | Vm                   | 0        |
| LVTUN0                | Length dependence of VTUN0                        | Vm                   | 0        |
| LW0                   | Length dependence of W0                           | $m^2$                | 0        |
| LWR                   | Length dependence of WR                           | m                    | 0        |
| NBJT                  | Power coefficient of channel length               | –                    | 1        |
| NDIODE                | Diode non-ideality factor                         | –                    | 1        |
| NFACTOR               | Subthreshold swing factor                         | –                    | 1        |
| NGATE                 | Poly gate doping concentration                    | $cm^{-3}$            | 0        |
| NGIDL                 | GIDL Vds enhancement coefficient                  | V                    | 1.2      |
| NLX                   | Lateral non-uniform doping parameter              | m                    | 1.74e-07 |
| NRECFO                | Recombination non-ideality factor at forward bias | –                    | 2        |
| NRECRO                | Recombination non-ideality factor at reverse bias | –                    | 10       |

| Level=10<br>Parameter | Description   | Units             | Default |
|-----------------------|---|-------------------|---------|
| NTUN                  | Reverse tunneling non-ideality factor                     | –                 | 10      |
| PA0                   | Cross-term dependence of A0                               | m <sup>2</sup>    | 0       |
| PA1                   | Cross-term dependence of A1                               | m <sup>2</sup> /V | 0       |
| PA2                   | Cross-term dependence of A2                               | m <sup>2</sup>    | 0       |
| PAELY                 | Cross-term dependence of AELY                             | Vm                | 0       |
| PAGIDL                | Cross-term dependence of AGIDL                            | m <sup>2</sup> /Ω | 0       |
| PAGS                  | Cross-term dependence of AGS                              | m <sup>2</sup> /V | 0       |
| PAHLI                 | Cross-term dependence of AHLI                             | m <sup>2</sup>    | 0       |
| PALPHA0               | Cross-term dependence of ALPHA0                           | m <sup>3</sup> /V | 0       |
| PB0                   | Cross-term dependence of B0                               | m <sup>3</sup>    | 0       |
| PB1                   | Cross-term dependence of B1                               | m <sup>3</sup>    | 0       |
| PBETA0                | Cross-term dependence of BETA0                            | Vm <sup>2</sup>   | 0       |
| PBETA1                | Cross-term dependence of BETA1                            | m <sup>2</sup>    | 0       |
| PBETA2                | Cross-term dependence of BETA2                            | Vm <sup>2</sup>   | 0       |
| PBGIDL                | Cross-term dependence of BGIDL                            | Vm                | 0       |
| PCDSC                 | Cross-term dependence of CDSC                             | F                 | 0       |
| PCDSCB                | Cross-term dependence of CDSCB                            | F/V               | 0       |
| PCDSCD                | Cross-term dependence of CDSCD                            | F/V               | 0       |
| PCIT                  | Cross-term dependence of CIT                              | F                 | 0       |
| PCLM                  | Channel length modulation parameter                       | –                 | 1.3     |
| PDELTA                | Cross-term dependence of DELTA                            | Vm <sup>2</sup>   | 0       |
| PDIBLC1               | First output resistance DIBL effect correction parameter  | –                 | 0.39    |
| PDIBLC2               | Second output resistance DIBL effect correction parameter | –                 | 0.0086  |
| PDIBLCB               | Body effect coefficient of DIBL correction parameter      | V <sup>-1</sup>   | 0       |
| PDROUT                | Cross-term dependence of DROUT                            | m <sup>2</sup>    | 0       |
| PDSUB                 | Cross-term dependence of DSUB                             | m <sup>2</sup>    | 0       |
| PDVT0                 | Cross-term dependence of DVT0                             | m <sup>2</sup>    | 0       |
| PDVTOW                | Cross-term dependence of DVTOW                            | m                 | 0       |
| PDVT1                 | Cross-term dependence of DVT1                             | m <sup>2</sup>    | 0       |

| Level=10<br>Parameter | Description                      | Units                            | Default |
|-----------------------|----------------------------------|----------------------------------|---------|
| PDVT1W                | Cross-term dependence of DVT1W   | m                                | 0       |
| PDVT2                 | Cross-term dependence of DVT2    | m <sup>2</sup> /V                | 0       |
| PDVT2W                | Cross-term dependence of DVT2W   | m <sup>2</sup> /V                | 0       |
| PDWB                  | Cross-term dependence of DWB     | m <sup>3</sup> /V <sup>1/2</sup> | 0       |
| PDWG                  | Cross-term dependence of DWG     | m <sup>3</sup> /V <sup>1/2</sup> | 0       |
| PESATII               | Cross-term dependence of ESATII  | Vm                               | 0       |
| PETA0                 | Cross-term dependence of ETA0    | m <sup>2</sup>                   | 0       |
| PETAB                 | Cross-term dependence of ETAB    | m <sup>2</sup> /V                | 0       |
| PFBJTII               | Cross-term dependence of FBJTII  | m <sup>2</sup>                   | 0       |
| PISBJT                | Cross-term dependence of ISBJT   | A                                | 0       |
| PISDIF                | Cross-term dependence of ISDIF   | A                                | 0       |
| PISREC                | Cross-term dependence of ISREC   | A                                | 0       |
| PISTUN                | Cross-term dependence of ISTUN   | A                                | 0       |
| PK1                   | Cross-term dependence of K1      | V <sup>1/2</sup> m <sup>2</sup>  | 0       |
| PK1W1                 | Cross-term dependence of K1W1    | m <sup>3</sup>                   | 0       |
| PK1W2                 | Cross-term dependence of K1W2    | m <sup>3</sup>                   | 0       |
| PK2                   | Cross-term dependence of K2      | m <sup>2</sup>                   | 0       |
| PK3                   | Cross-term dependence of K3      | m <sup>2</sup>                   | 0       |
| PK3B                  | Cross-term dependence of K3B     | m <sup>2</sup> /V                | 0       |
| PKETA                 | Cross-term dependence of KETA    | m <sup>2</sup> /V                | 0       |
| PKETAS                | Cross-term dependence of KETAS   | Vm <sup>2</sup>                  | 0       |
| PLBJT0                | Cross-term dependence of LBJT0   | m <sup>3</sup>                   | 0       |
| PLII                  | Cross-term dependence of LII     | m <sup>2</sup>                   | 0       |
| PNBJT                 | Cross-term dependence of NBJT    | m <sup>2</sup>                   | 0       |
| PNDIODE               | Cross-term dependence of NDIODE  | m <sup>2</sup>                   | 0       |
| PNFACTOR              | Cross-term dependence of NFACTOR | m <sup>2</sup>                   | 0       |
| PNGATE                | Cross-term dependence of NGATE   | m <sup>2</sup> /cm <sup>3</sup>  | 0       |
| PNGIDL                | Cross-term dependence of NGIDL   | Vm <sup>2</sup>                  | 0       |
| PNLX                  | Cross-term dependence of NLX     | m <sup>3</sup>                   | 0       |

| Level=10<br>Parameter | Description                          | Units                               | Default |
|-----------------------|--------------------------------------|-------------------------------------|---------|
| PNRECF0               | Cross-term dependence of NRECF0      | m <sup>2</sup>                      | 0       |
| PNRECR0               | Cross-term dependence of NRECR0      | m <sup>2</sup>                      | 0       |
| PNTUN                 | Cross-term dependence of NTUN        | m <sup>2</sup>                      | 0       |
| PPCLM                 | Cross-term dependence of PCLM        | m <sup>2</sup>                      | 0       |
| PPDIBLC1              | Cross-term dependence of PDIBLC1     | m <sup>2</sup>                      | 0       |
| PPDIBLC2              | Cross-term dependence of PDIBLC2     | m <sup>2</sup>                      | 0       |
| PPDIBLCB              | Cross-term dependence of PDIBLCB     | m <sup>2</sup> /V                   | 0       |
| PPRWB                 | Cross-term dependence of PRWB        | m <sup>2</sup> /V <sup>1/2</sup>    | 0       |
| PPRWG                 | Cross-term dependence of PRWG        | m <sup>2</sup> /V                   | 0       |
| PPVAG                 | Cross-term dependence of PVAG        | m <sup>2</sup>                      | 0       |
| PRDSW                 | Cross-term dependence of RDSW        | $\Omega - \mu\text{m} - \text{m}^2$ | 0       |
| PRWB                  | Body effect coefficient of RDSW      | V <sup>-1/2</sup>                   | 0       |
| PRWG                  | Gate-bias effect coefficient of RDSW | V <sup>-1</sup>                     | 0       |
| PSII0                 | Cross-term dependence of SII0        | m <sup>2</sup> /V                   | 0       |
| PSII1                 | Cross-term dependence of SII1        | m <sup>2</sup> /V                   | 0       |
| PSII2                 | Cross-term dependence of SII2        | m <sup>2</sup>                      | 0       |
| PSIID                 | Cross-term dependence of SIID        | m <sup>2</sup> /V                   | 0       |
| PUA                   | Cross-term dependence of UA          | m <sup>3</sup> /V                   | 0       |
| PUB                   | Cross-term dependence of UB          | m <sup>4</sup> /V <sup>2</sup>      | 0       |
| PUC                   | Cross-term dependence of UC          | m <sup>3</sup> /V <sup>2</sup>      | 0       |
| PVABJT                | Cross-term dependence of VABJT       | Vm <sup>2</sup>                     | 0       |
| PVAG                  | Gate dependence of early voltage     | –                                   | 0       |
| PVDSATII0             | Cross-term dependence of VDSATII0    | Vm <sup>2</sup>                     | 0       |
| PVOFF                 | Cross-term dependence of VOFF        | Vm <sup>2</sup>                     | 0       |
| PVREC0                | Cross-term dependence of VREC0       | Vm <sup>2</sup>                     | 0       |
| PVSAT                 | Cross-term dependence of VSAT        | m <sup>3</sup> /s                   | 0       |
| PVTH0                 | Cross-term dependence of VTH0        | Vm <sup>2</sup>                     | 0       |
| PVTUN0                | Cross-term dependence of VTUN0       | Vm <sup>2</sup>                     | 0       |
| PW0                   | Cross-term dependence of W0          | m <sup>3</sup>                      | 0       |

| Level=10<br>Parameter | Description   | Units                          | Default   |
|-----------------------|---|--------------------------------|-----------|
| PWR                   | Cross-term dependence of WR   | m <sup>2</sup>                 | 0         |
| RBODY                 | Intrinsic body contact sheet resistance   | ohm/square                     | 0         |
| RBSH                  | Intrinsic body contact sheet resistance   | ohm/square                     | 0         |
| RDSW                  | Parasitic resistance per unit width   | $\Omega - \mu\text{m}$         | 100       |
| RHALO                 | Body halo sheet resistance  | ohm/m                          | 1e+15     |
| SII0                  | First Vgs dependent parameter of impact ionization current                        | V <sup>-1</sup>                | 0.5       |
| SII1                  | Second Vgs dependent parameter of impact ionization current                       | V <sup>-1</sup>                | 0.1       |
| SII2                  | Third Vgs dependent parameter of impact ionization current                        | -                              | 0         |
| SIID                  | Vds dependent parameter of drain saturation voltage for impact ionization current | V <sup>-1</sup>                | 0         |
| TII                   | Temperature dependent parameter for impact ionization current                     | -                              | 0         |
| UA                    | First-order mobility degradation coefficient                                      | m/V                            | 2.25e-09  |
| UB                    | First-order mobility degradation coefficient                                      | m <sup>2</sup> /V <sup>2</sup> | 5.87e-19  |
| UC                    | Body effect of mobility degradation coefficient                                   | m/V <sup>2</sup>               | -4.65e-11 |
| VABJT                 | Early voltage for bipolar current   | V                              | 10        |
| VBM                   | Maximum applied body-bias in threshold voltage calculation                        | V                              | -3        |
| VDSATII0              | Normal drain saturation voltage at threshold for impact ionization current        | V                              | 0.9       |
| VOFF                  | Offset voltage in the subthreshold region at large W and L                        | V                              | -0.08     |
| VRECO                 | Voltage dependent parameter for recombination current                             | V                              | 0         |
| VSAT                  | Saturation velocity at temp = TNOM  | m/s                            | 80000     |
| VTH0                  | Threshold voltage at Vbs = 0 for large L  | V                              | 0.7       |
| VTUNO                 | Voltage dependent parameter for tunneling current                                 | V                              | 0         |
| W0                    | Narrow-width parameter  | m                              | 2.5e-06   |



| Level=10<br>Parameter | Description                | Units                            | Default |
|-----------------------|----------------------------|----------------------------------|---------|
| WA0                   | Width dependence of A0     | m                                | 0       |
| WA1                   | Width dependence of A1     | m/V                              | 0       |
| WA2                   | Width dependence of A2     | m                                | 0       |
| WAELY                 | Width dependence of AELY   | V                                | 0       |
| WAGIDL                | Width dependence of AGIDL  | m/Ω                              | 0       |
| WAGS                  | Width dependence of AGS    | m/V                              | 0       |
| WAHLI                 | Width dependence of AHLI   | m                                | 0       |
| WALPHA0               | Width dependence of ALPHA0 | m <sup>2</sup> /V                | 0       |
| WB0                   | Width dependence of B0     | m <sup>2</sup>                   | 0       |
| WB1                   | Width dependence of B1     | m <sup>2</sup>                   | 0       |
| WBETA0                | Width dependence of BETA0  | Vm                               | 0       |
| WBETA1                | Width dependence of BETA1  | m                                | 0       |
| WBETA2                | Width dependence of BETA2  | Vm                               | 0       |
| WBGIDL                | Width dependence of BGIDL  | V                                | 0       |
| WCDCS                 | Width dependence of CDSC   | F/m                              | 0       |
| WCDCSB                | Width dependence of CDSCB  | F/(Vm)                           | 0       |
| WCDCSD                | Width dependence of CDSCD  | F/(Vm)                           | 0       |
| WCIT                  | Width dependence of CIT    | F/m                              | 0       |
| WDELTA                | Width dependence of DELTA  | Vm                               | 0       |
| WDROUT                | Width dependence of DROUT  | m                                | 0       |
| WDSUB                 | Width dependence of DSUB   | m                                | 0       |
| WDVT0                 | Width dependence of DVT0   | m                                | 0       |
| WDVT0W                | Width dependence of DVT0W  | –                                | 0       |
| WDVT1                 | Width dependence of DVT1   | m                                | 0       |
| WDVT1W                | Width dependence of DVT1W  | –                                | 0       |
| WDVT2                 | Width dependence of DVT2   | m/V                              | 0       |
| WDVT2W                | Width dependence of DVT2W  | m/V                              | 0       |
| WDWB                  | Width dependence of DWB    | m <sup>2</sup> /V <sup>1/2</sup> | 0       |
| WDWG                  | Width dependence of DWG    | m <sup>2</sup> /V <sup>1/2</sup> | 0       |

| Level=10<br>Parameter | Description  | Units      | Default |
|-----------------------|--|------------|---------|
| WESATII               | Width dependence of ESATII                           | V          | 0       |
| WETAO                 | Width dependence of ETA0                             | m          | 0       |
| WETAB                 | Width dependence of ETAB                             | m/V        | 0       |
| WFBJTII               | Width dependence of FBJTII                           | m          | 0       |
| WINT                  | Width-offset fitting parameter from I-V without bias | m          | 0       |
| WISBJT                | Width dependence of ISBJT                            | A/m        | 0       |
| WISDIF                | Width dependence of ISDIF                            | A/m        | 0       |
| WISREC                | Width dependence of ISREC                            | A/m        | 0       |
| WISTUN                | Width dependence of ISTUN                            | A/m        | 0       |
| WK1                   | Width dependence of K1                               | $V^{1/2}m$ | 0       |
| WK1W1                 | Width dependence of K1W1                             | $m^2$      | 0       |
| WK1W2                 | Width dependence of K1W2                             | $m^2$      | 0       |
| WK2                   | Width dependence of K2                               | m          | 0       |
| WK3                   | Width dependence of K3                               | m          | 0       |
| WK3B                  | Width dependence of K3B                              | m/V        | 0       |
| WKETA                 | Width dependence of KETA                             | m/V        | 0       |
| WKETAS                | Width dependence of KETAS                            | Vm         | 0       |
| WLBJT0                | Width dependence of LBJT0                            | $m^2$      | 0       |
| WLII                  | Width dependence of LII                              | m          | 0       |
| WNBJT                 | Width dependence of NBJT                             | m          | 0       |
| WNDIODE               | Width dependence of NDIODE                           | m          | 0       |
| WNFACTOR              | Width dependence of NFACTOR                          | m          | 0       |
| WNGATE                | Width dependence of NGATE                            | $m/cm^3$   | 0       |
| WNGIDL                | Width dependence of NGIDL                            | Vm         | 0       |
| WNLX                  | Width dependence of NLX                              | $m^2$      | 0       |
| WNRECF0               | Width dependence of NRECF0                           | m          | 0       |
| WNRECR0               | Width dependence of NRECR0                           | m          | 0       |
| WNTUN                 | Width dependence of NTUN                             | m          | 0       |
| WPCLM                 | Width dependence of PCLM                             | m          | 0       |

| Level=10<br>Parameter    | Description                                | Units                           | Default |
|--------------------------|--|---------------------------------|---------|
| WPDIBLC1                 | Width dependence of PDIBLC1                | m                               | 0       |
| WPDIBLC2                 | Width dependence of PDIBLC2                | m                               | 0       |
| WPDIBLCB                 | Width dependence of PDIBLCB                | m/V                             | 0       |
| WPRWB                    | Width dependence of PRWB                   | m/V <sup>1/2</sup>              | 0       |
| WPRWG                    | Width dependence of PRWG                   | m/V                             | 0       |
| WPVAG                    | Width dependence of PVAG                   | m                               | 0       |
| WR                       | Width offset from Weff for Rds Calculation | –                               | 1       |
| WRDSW                    | Width dependence of RDSW                   | $\Omega - \mu\text{m}$<br>m     | 0       |
| WSII0                    | Width dependence of SII0                   | m/V                             | 0       |
| WSII1                    | Width dependence of SII1                   | m/V                             | 0       |
| WSII2                    | Width dependence of SII2                   | m                               | 0       |
| WSIID                    | Width dependence of SIID                   | m/V                             | 0       |
| WUA                      | Width dependence of UA                     | m <sup>2</sup> /V               | 0       |
| WUB                      | Width dependence of UB                     | m <sup>3</sup> /V <sup>2</sup>  | 0       |
| WUC                      | Width dependence of UC                     | m <sup>2</sup> /V <sup>2</sup>  | 0       |
| WVABJT                   | Width dependence of VABJT                  | Vm                              | 0       |
| WVDSATII0                | Width dependence of VDSATII0               | Vm                              | 0       |
| WVOFF                    | Width dependence of VOFF                   | Vm                              | 0       |
| WVRECO                   | Width dependence of VRECO                  | Vm                              | 0       |
| WVSAT                    | Width dependence of VSAT                   | m <sup>2</sup> /s               | 0       |
| WVTH0                    | Width dependence of VTH0                   | Vm                              | 0       |
| WVTUN0                   | Width dependence of VTUN0                  | Vm                              | 0       |
| WVO                      | Width dependence of W0                     | m <sup>2</sup>                  | 0       |
| WWR                      | Width dependence of WR                     | m                               | 0       |
| <b>Doping Parameters</b> |  |                                 |         |
| LNSUB                    | Length dependence of NSUB                  | m/cm <sup>3</sup>               | 0       |
| NSUB                     | Substrate doping density                   | cm <sup>-3</sup>                | 6e+16   |
| PNSUB                    | Cross-term dependence of NSUB              | m <sup>2</sup> /cm <sup>3</sup> | 0       |
| WNSUB                    | Width dependence of NSUB                   | m/cm <sup>3</sup>               | 0       |

| Level=10<br>Parameter             | Description   | Units         | Default   |
|-----------------------------------|---|---------------|-----------|
| <b><i>Flicker Parameters</i></b>  |   |               |           |
| AF                                | Flicker noise exponent  | –             | 1         |
| EF                                | Flicker exponent  | –             | 1         |
| EM                                | Saturation field  | V/m           | 4.1e+07   |
| KF                                | Flicker noise coefficient   | –             | 0         |
| NOIA                              | Noise parameter a   | –             | 6.25e+41  |
| NOIB                              | Noise parameter b   | –             | 3.125e+26 |
| NOIC                              | Noise parameter c   | –             | 8.75e+09  |
| <b><i>Geometry Parameters</i></b> |   |               |           |
| L                                 | Default channel length  | m             | 5e-06     |
| LL                                | Coefficient of length dependence for length offset                      | $m^{LLN}$     | 0         |
| LLC                               | Coefficient of length dependence for CV channel length offset           | $m^{LLN}$     | 0         |
| LLN                               | Power of length dependence for length offset                            | –             | 1         |
| LW                                | Coefficient of width dependence for length offset                       | $m^{LWN}$     | 0         |
| LWC                               | Coefficient of width dependence for channel length offset               | $m^{LWN}$     | 0         |
| LWL                               | Coefficient of length and width cross term for length offset            | $m^{LLN+LWN}$ | 0         |
| LWLC                              | Coefficient of length and width dependence for CV channel length offset | $m^{LLN+LWN}$ | 0         |
| LWN                               | Power of width dependence for length offset                             | –             | 1         |
| LXJ                               | Length dependence of XJ   | $m^2$         | 0         |
| PXJ                               | Cross-term dependence of XJ   | $m^3$         | 0         |
| TOX                               | Gate oxide thickness  | m             | 1e-08     |
| W                                 | Default channel width   | m             | 5e-06     |
| WL                                | Coefficient of length dependence for width offset                       | $m^{WLN}$     | 0         |
| WLC                               | Coefficient of length dependence for CV channel width offset            | $m^{WLN}$     | 0         |
| WLN                               | Power of length dependence of width offset                              | –             | 1         |
| WW                                | Coefficient of width dependence for width offset                        | $m^{WWN}$     | 0         |

| Level=10<br>Parameter        | Description  | Units          | Default  |
|------------------------------|--|----------------|----------|
| WWC                          | Coefficient of width dependence for CV channel width offset            | $m^{WWN}$      | 0        |
| WWL                          | Coefficient of length and width cross term for width offset            | $m^{WLN+WWN}$  | 0        |
| WWLC                         | Coefficient of length and width dependence for CV channel width offset | $m^{WLN+WWN}$  | 0        |
| WWN                          | Power of width dependence of width offset                              | –              | 1        |
| WXJ                          | Width dependence of XJ   | $m^2$          | 0        |
| XJ                           | Junction depth   | m              | 1e-07    |
| <b>Resistance Parameters</b> |  |                |          |
| RSH                          | Drain, source diffusion sheet resistance                               | $\Omega$       | 0        |
| <b>Process Parameters</b>    |  |                |          |
| GAMMA1                       | Body effect coefficient near the surface                               | $V^{1/2}$      | 0        |
| GAMMA2                       | Body effect coefficient in the bulk                                    | $V^{1/2}$      | 0        |
| LNCH                         | Length dependence of NCH   | $m/cm^3$       | 0        |
| LU0                          | Length dependence of U0  | $m/(Vcm^2s)$   | 0        |
| NCH                          | Channel doping concentration   | $cm^{-3}$      | 1.7e+17  |
| PNCH                         | Cross-term dependence of NCH   | $m^2/cm^3$     | 0        |
| PU0                          | Cross-term dependence of U0  | $m^2/(Vcm^2s)$ | 0        |
| TBOX                         | Buried oxide thickness   | m              | 3e-07    |
| TOXM                         | Gate oxide thickness used in extraction                                | m              | 1e-08    |
| TSI                          | Silicon film thickness   | m              | 1e-07    |
| U0                           | Surface mobility   | $1/(Vcm^2s)$   | 0.067    |
| VBX                          | Vbs at which the depletion region = XT                                 | V              | 0        |
| WNCH                         | Width dependence of NCH  | $m/cm^3$       | 0        |
| WU0                          | Width dependence of U0   | $m/(Vcm^2s)$   | 0        |
| XT                           | Doping depth   | m              | 1.55e-07 |
| <b>RF Parameters</b>         |  |                |          |
| LXRRCG1                      | Length dependence of XRRCG1  | m              | 0        |
| LXRRCG2                      | Length dependence of XRRCG2  | m              | 0        |
| NGCON                        | Number of gate contacts  | –              | 1        |

| Level=10<br>Parameter         | Description   | Units                                 | Default |
|-------------------------------|---|---------------------------------------|---------|
| PXRCRG1                       | Cross-term dependence of XRCRG1   | m <sup>2</sup>                        | 0       |
| PXRCRG2                       | Cross-term dependence of XRCRG2   | m <sup>2</sup>                        | 0       |
| RGATEMOD                      | Gate resistance model selector  | –                                     | 0       |
| WXRCRG1                       | Width dependence of XRCRG1  | m                                     | 0       |
| WXRCRG2                       | Width dependence of XRCRG2  | m                                     | 0       |
| XGL                           | Offset of the gate length due to variations in patterning                                       | m                                     | 0       |
| XGW                           | Distance from the gate contact to the channel edge  | m                                     | 0       |
| XRCRG1                        | Parameter for distributed channel resistance effect for intrinsic input resistance              | –                                     | 12      |
| XRCRG2                        | Parameter to account for the excess channel diffusion resistance for intrinsic input resistance | –                                     | 1       |
| <b>Temperature Parameters</b> |   |                                       |         |
| AT                            | Temperature coefficient for saturation velocity   | m/s                                   | 33000   |
| CTHO                          | Thermal capacitance per unit width  | F/m                                   | 1e-05   |
| KT1                           | Temperature coefficient for threshold voltage   | V                                     | -0.11   |
| KT1L                          | Channel length dependence of the temperature coefficient for the threshold voltage              | Vm                                    | 0       |
| KT2                           | Body-bias coefficient fo the threshold voltage temperature effect                               | –                                     | 0.022   |
| LAT                           | Length dependence of AT   | m <sup>2</sup> /s                     | 0       |
| LKT1                          | Length dependence of KT1  | Vm                                    | 0       |
| LKT1L                         | Length dependence of KT1L   | Vm <sup>2</sup>                       | 0       |
| LKT2                          | Length dependence of KT2  | m                                     | 0       |
| LNTRECF                       | Length dependence of NTRECF   | m                                     | 0       |
| LNTRECR                       | Length dependence of NTRECR   | m                                     | 0       |
| LPRT                          | Length dependence of PRT  | Ω – μm-<br>m                          | 0       |
| LUA1                          | Length dependence of UA1  | m <sup>2</sup> /V                     | 0       |
| LUB1                          | Length dependence of UB1  | m <sup>3</sup> /V <sup>2</sup>        | 0       |
| LUC1                          | Length dependence of UC1  | m <sup>2</sup> /((°CV <sup>2</sup> )) | 0       |
| LUTE                          | Length dependence of UTE  | m                                     | 0       |

| Level=10<br>Parameter | Description                       | Units                               | Default  |
|-----------------------|-----------------------------------|-------------------------------------|----------|
| LXBJT                 | Length dependence of XBJT         | m                                   | 0        |
| LXDIF                 | Length dependence of XDIF         | m                                   | 0        |
| LXREC                 | Length dependence of XREC         | m                                   | 0        |
| LXTUN                 | Length dependence of XTUN         | m                                   | 0        |
| NTRECF                | Temperature coefficient for NRECF | –                                   | 0        |
| NTRECR                | Temperature coefficient for NRECR | –                                   | 0        |
| PAT                   | Cross-term dependence of AT       | m <sup>3</sup> /s                   | 0        |
| PKT1                  | Cross-term dependence of KT1      | Vm <sup>2</sup>                     | 0        |
| PKT1L                 | Cross-term dependence of KT1L     | Vm <sup>3</sup>                     | 0        |
| PKT2                  | Cross-term dependence of KT2      | m <sup>2</sup>                      | 0        |
| PNTRECF               | Cross-term dependence of NTRECF   | m <sup>2</sup>                      | 0        |
| PNTRECR               | Cross-term dependence of NTRECR   | m <sup>2</sup>                      | 0        |
| PPRT                  | Cross-term dependence of PRT      | $\Omega - \mu\text{m} - \text{m}^2$ | 0        |
| PRT                   | Temperature coefficient for RDSW  | $\Omega - \mu\text{m}$              | 0        |
| PUA1                  | Cross-term dependence of UA1      | m <sup>3</sup> /V                   | 0        |
| PUB1                  | Cross-term dependence of UB1      | m <sup>4</sup> /V <sup>2</sup>      | 0        |
| PUC1                  | Cross-term dependence of UC1      | m <sup>3</sup> /(°CV <sup>2</sup> ) | 0        |
| PUTE                  | Cross-term dependence of UTE      | m <sup>2</sup>                      | 0        |
| PXBJT                 | Cross-term dependence of XBJT     | m <sup>2</sup>                      | 0        |
| PXDIF                 | Cross-term dependence of XDIF     | m <sup>2</sup>                      | 0        |
| PXREC                 | Cross-term dependence of XREC     | m <sup>2</sup>                      | 0        |
| PXTUN                 | Cross-term dependence of XTUN     | m <sup>2</sup>                      | 0        |
| RTH0                  | Thermal resistance per unit width | $\Omega/\text{m}$                   | 0        |
| TCJSWG                | Temperature coefficient of Cjswg  | °K <sup>-1</sup>                    | 0        |
| TNOM                  | Nominal device temperature        | °C                                  | 27       |
| TPBSWG                | Temperature coefficient of Pbswg  | V/K                                 | 0        |
| UA1                   | Temperature coefficient for UA    | m/V                                 | 4.31e-09 |

| Level=10<br>Parameter               | Description  | Units                | Default   |
|-------------------------------------|--|----------------------|-----------|
| UB1                                 | Temperature coefficient for UB                                 | $m^2/V^2$            | -7.61e-18 |
| UC1                                 | Temperature coefficient for UC                                 | $m/(^{\circ}CV^2)$   | -5.6e-11  |
| UTE                                 | Mobility temperature exponent                                  | –                    | -1.5      |
| WAT                                 | Width dependence of AT   | $m^2/s$              | 0         |
| WKT1                                | Width dependence of KT1  | $Vm$                 | 0         |
| WKT1L                               | Width dependence of KT1L                                       | $Vm^2$               | 0         |
| WKT2                                | Width dependence of KT2  | $m$                  | 0         |
| WNTRECF                             | Width dependence of NTRECF                                     | $m$                  | 0         |
| WNTRECR                             | Width dependence of NTRECR                                     | $m$                  | 0         |
| WPRT                                | Width dependence of PRT  | $\Omega - \mu m - m$ | 0         |
| WTH0                                | Minimum width for thermal resistance calculation               | $m$                  | 0         |
| WUA1                                | Width dependence of UA1  | $m^2/V$              | 0         |
| WUB1                                | Width dependence of UB1  | $m^3/V^2$            | 0         |
| WUC1                                | Width dependence of UC1  | $m^2/(^{\circ}CV^2)$ | 0         |
| WUTE                                | Width dependence of UTE  | $m$                  | 0         |
| WXBJT                               | Width dependence of XBJT                                       | $m$                  | 0         |
| WXDIF                               | Width dependence of XDIF                                       | $m$                  | 0         |
| WXREC                               | Width dependence of XREC                                       | $m$                  | 0         |
| WXTUN                               | Width dependence of XTUN                                       | $m$                  | 0         |
| XBJT                                | Power dependence of JBJT on temperature                        | –                    | 1         |
| XDIF                                | Power dependence of JDIF on temperature                        | –                    | 1         |
| XREC                                | Power dependence of JREC on temperature                        | –                    | 1         |
| XTUN                                | Power dependence of JTUN on temperature                        | –                    | 0         |
| <b><i>Tunnelling Parameters</i></b> |  |                      |           |
| ALPHAGB1                            | First Vox dependent parameter for gate current in inversion    | $V^{-1}$             | 0.35      |
| ALPHAGB2                            | First Vox dependent parameter for gate current in accumulation | $V^{-1}$             | 0.43      |



| Level=10<br>Parameter | Description  | Units     | Default |
|-----------------------|--|-----------|---------|
| BETAGB1               | Second Vox dependent parameter for gate current in inversion   | $V^{-2}$  | 0.03    |
| BETAGB2               | First Vox dependent parameter for gate current in accumulation | $V^{-2}$  | 0.05    |
| EBG                   | Effective bandgap in gate current calculation                  | V         | 1.2     |
| IGMOD                 | Gate current model selector                                    | –         | 0       |
| LALPHAGB1             | Length dependence of ALPHAGB1                                  | m/V       | 0       |
| LALPHAGB2             | Length dependence of ALPHAGB2                                  | m/V       | 0       |
| LBETAGB1              | Length dependence of BETAGB1                                   | $m/V^2$   | 0       |
| LBETAGB2              | Length dependence of BETAGB2                                   | $m/V^2$   | 0       |
| NTOX                  | Power term of gate current                                     | –         | 1       |
| PALPHAGB1             | Cross-term dependence of ALPHAGB1                              | $m^2/V$   | 0       |
| PALPHAGB2             | Cross-term dependence of ALPHAGB2                              | $m^2/V$   | 0       |
| PBETAGB1              | Cross-term dependence of BETAGB1                               | $m^2/V^2$ | 0       |
| PBETAGB2              | Cross-term dependence of BETAGB2                               | $m^2/V^2$ | 0       |
| TOXQM                 | Oxide thickness for Igb calculation                            | m         | 1e-08   |
| TOXREF                | Target oxide thickness   | m         | 2.5e-09 |
| VECB                  | Vaux parameter for conduction band electron tunneling          | –         | 0.026   |
| VEVB                  | Vaux parameter for valence band electron tunneling             | –         | 0.075   |
| VGB1                  | Third Vox dependent parameter for gate current in inversion    | V         | 300     |
| VGB2                  | Third Vox dependent parameter for gate current in accumulation | V         | 17      |
| WALPHAGB1             | Width dependence of ALPHAGB1                                   | m/V       | 0       |
| WALPHAGB2             | Width dependence of ALPHAGB2                                   | m/V       | 0       |
| WBETAGB1              | Width dependence of BETAGB1                                    | $m/V^2$   | 0       |
| WBETAGB2              | Width dependence of BETAGB2                                    | $m/V^2$   | 0       |
| DK2B                  | Third backgate body effect parameter for short channel effect  | –         | 0       |
| DVBD0                 | First short channel effect parameter in FD module              | –         | 0       |
| DVBD1                 | Second short channel effect parameter in FD module             | –         | 0       |

| Level=10<br>Parameter | Description   | Units | Default |
|-----------------------|---|-------|---------|
| K1B                   | First backgate body effect parameter  | –     | 1       |
| K2B                   | Second backgate body effect parameter for short channel effect                                    | –     | 0       |
| MOINFD                | Gate bias dependence coefficient of surface potential in FD module                                | –     | 1000    |
| NOFFFD                | Smoothing parameter in FD module  | –     | 1       |
| SOIMOD                | SIO model selector, SOIMOD=0: BSIMPD, SOIMOD=1: undefined model for PD and FE, SOIMOD=2: ideal FD | –     | 0       |
| VBSA                  | Offset voltage due to non-idealities  | V     | 0       |
| VOFFFD                | Smoothing parameter in FD module  | V     | 0       |

Table 2.31: BSIM3 SOI Device Model Parameters.

#### Model level 14 (BSIM4)

The level 14 MOSFET device in **Xyce** is based on the Berkeley BSIM4 model version 4.6.1. Its parameters are given in the following tables. Note that the table is not yet in its final form and parameters have not all been properly categorized with units in place. This will be corrected in the final SAND report version of the guide. Please see the BSIM4 web site for full documentation of these parameters.

| Parameter | Description             | Units | Default |
|-----------|-------------------------|-------|---------|
| AD        | Drain area              | –     | 0       |
| AS        | Source area             | –     | 0       |
| L         | Length                  | –     | 5e-06   |
| MIN       | Minimize either D or S  | –     | 0       |
| NF        | Number of fingers       | –     | 1       |
| NGCON     | Number of gate contacts | –     | 1       |
| OFF       | Device is initially off | –     | False   |
| PD        | Drain perimeter         | –     | 0       |
| PS        | Source perimeter        | –     | 0       |
| RBDB      | Body resistance         | –     | 50      |
| RBPB      | Body resistance         | –     | 50      |

| Parameter   | Description  | Units | Default |
|---|--|-------|---------|
| RBPD  | Body resistance  | –     | 50      |
| RBPS  | Body resistance  | –     | 50      |
| RBSB  | Body resistance  | –     | 50      |
| SA  | distance between OD edge to poly of one side                           | –     | 0       |
| SB  | distance between OD edge to poly of the other side                     | –     | 0       |
| SC  | Distance to a single well edge   | –     | 0       |
| SCA   | Integral of the first distribution function for scattered well dopant  | –     | 0       |
| SCB   | Integral of the second distribution function for scattered well dopant | –     | 0       |
| SCC   | Integral of the third distribution function for scattered well dopant  | –     | 0       |
| SD  | distance between neighbour fingers                                     | –     | 0       |
| W   | Width  | –     | 5e-06   |
| XGW   | Distance from gate contact center to device edge                       | –     | 0       |
| <b>Basic Parameters</b>   |  |       |         |
| DELVTO  | Zero bias threshold voltage variation                                  | V     | 0       |
| <b>Control Parameters</b>   |  |       |         |
| ACNQSMOD  | AC NQS model selector  | –     | 0       |
| GEOMOD  | Geometry dependent parasitics model selector                           | –     | 0       |
| M   | Multiplier for M devices connected in parallel                         | –     | 1       |
| RBODYMOD  | Distributed body R model selector                                      | –     | 0       |
| RGATEMOD  | Gate resistance model selector   | –     | 0       |
| RGEOMOD   | S/D resistance and contact model selector                              | –     | 0       |
| TRNQSMOD  | Transient NQS model selector   | –     | 0       |
| <b>Temperature Parameters</b>                                       |  |       |         |
| TEMP  | Device temperature   | °C    | 27      |
| <b>Voltage Parameters</b>   |  |       |         |
| IC  | Vector of initial values: Vds, Vgs, Vbs                                | V     | 0       |
| <b>Asymmetric and Bias-Dependent <math>R_{ds}</math> Parameters</b> |  |       |         |
| NRD   | Number of squares in drain   | –     | 1       |
| NRS   | Number of squares in source  | –     | 1       |

| Parameter | Description | Units | Default |
|-----------|-------------|-------|---------|
|-----------|-------------|-------|---------|

Table 2.32: BSIM4 Device Instance Parameters.

| Parameter | Description   | Units           | Default |
|-----------|---|-----------------|---------|
| AF        | Flicker noise exponent  | –               | 1       |
| AIGSD     | Parameter for I <sub>gs,d</sub>                                 | –               | 0.0136  |
| AT        | Temperature coefficient of v <sub>sat</sub>                     | –               | 33000   |
| BIGSD     | Parameter for I <sub>gs,d</sub>                                 | –               | 0.00171 |
| BVD       | Drain diode breakdown voltage                                   | –               | 10      |
| BVS       | Source diode breakdown voltage                                  | –               | 10      |
| CIGSD     | Parameter for I <sub>gs,d</sub>                                 | –               | 0.075   |
| CJD       | Drain bottom junction capacitance per unit area                 | –               | 0.0005  |
| CJS       | Source bottom junction capacitance per unit area                | –               | 0.0005  |
| CJSWD     | Drain sidewall junction capacitance per unit periphery          | –               | 5e-10   |
| CJSWGD    | Drain (gate side) sidewall junction capacitance per unit width  | –               | 5e-10   |
| CJSWGS    | Source (gate side) sidewall junction capacitance per unit width | –               | 5e-10   |
| CJSWS     | Source sidewall junction capacitance per unit periphery         | –               | 5e-10   |
| DLCIG     | Delta L for I <sub>g</sub> model                                | –               | 0       |
| DMCG      | Distance of Mid-Contact to Gate edge                            | –               | 0       |
| DMCGT     | Distance of Mid-Contact to Gate edge in Test structures         | –               | 0       |
| DMCI      | Distance of Mid-Contact to Isolation                            | –               | 0       |
| DMDG      | Distance of Mid-Diffusion to Gate edge                          | –               | 0       |
| DWJ       | Delta W for S/D junctions                                       | –               | 0       |
| EF        | Flicker noise frequency exponent                                | –               | 1       |
| EM        | Flicker noise parameter   | –               | 4.1e+07 |
| EPSRGATE  | Dielectric constant of gate relative to vacuum                  | –               | 11.7    |
| GBMIN     | Minimum body conductance  | Ω <sup>-1</sup> | 1e-12   |
| IJTHDFWD  | Forward drain diode forward limiting current                    | –               | 0.1     |
| IJTHDREV  | Reverse drain diode forward limiting current                    | –               | 0.1     |
| IJTHSFWD  | Forward source diode forward limiting current                   | –               | 0.1     |

| Parameter | Description  | Units | Default |
|-----------|--|-------|---------|
| IJTHSREV  | Reverse source diode forward limiting current                              | –     | 0.1     |
| JSD       | Bottom drain junction reverse saturation current density                   | –     | 0.0001  |
| JSS       | Bottom source junction reverse saturation current density                  | –     | 0.0001  |
| JSWD      | Isolation edge sidewall drain junction reverse saturation current density  | –     | 0       |
| JSWGD     | Gate edge drain junction reverse saturation current density                | –     | 0       |
| JSWGS     | Gate edge source junction reverse saturation current density               | –     | 0       |
| JSWS      | Isolation edge sidewall source junction reverse saturation current density | –     | 0       |
| JTSD      | Drain bottom trap-assisted saturation current density                      | –     | 0       |
| JTSS      | Source bottom trap-assisted saturation current density                     | –     | 0       |
| JTSSWD    | Drain STI sidewall trap-assisted saturation current density                | –     | 0       |
| JTSSWGD   | Drain gate-edge sidewall trap-assisted saturation current density          | –     | 0       |
| JTSSWGS   | Source gate-edge sidewall trap-assisted saturation current density         | –     | 0       |
| JTSSWS    | Source STI sidewall trap-assisted saturation current density               | –     | 0       |
| K2WE      | K2 shift factor for well proximity effect                                  | –     | 0       |
| K3B       | Body effect coefficient of k3  | –     | 0       |
| KF        | Flicker noise coefficient  | –     | 0       |
| KT1       | Temperature coefficient of Vth   | –     | -0.11   |
| KT1L      | Temperature coefficient of Vth   | –     | 0       |
| KT2       | Body-coefficient of kt1  | –     | 0.022   |
| KU0       | Mobility degradation/enhancement coefficient for LOD                       | –     | 0       |
| KU0WE     | Mobility degradation factor for well proximity effect                      | –     | 0       |
| KVSAT     | Saturation velocity degradation/enhancement parameter for LOD              | –     | 0       |
| KVTHO     | Threshold degradation/enhancement parameter for LOD                        | –     | 0       |

| Parameter | Description                                      | Units | Default |
|-----------|--|-------|---------|
| KVTHOWE   | Threshold shift factor for well proximity effect | –     | 0       |
| LA0       | Length dependence of a0                          | –     | 0       |
| LA1       | Length dependence of a1                          | –     | 0       |
| LA2       | Length dependence of a2                          | –     | 0       |
| LACDE     | Length dependence of acde                        | –     | 0       |
| LAGIDL    | Length dependence of agidl                       | –     | 0       |
| LAGISL    | Length dependence of agisl                       | –     | 0       |
| LAGS      | Length dependence of ags                         | –     | 0       |
| LAIGBACC  | Length dependence of aigbacc                     | –     | 0       |
| LAIGBINV  | Length dependence of aigbinv                     | –     | 0       |
| LAIGC     | Length dependence of aigc                        | –     | 0       |
| LAIGD     | Length dependence of aigd                        | –     | 0       |
| LAIGS     | Length dependence of aigs                        | –     | 0       |
| LAIGSD    | Length dependence of aigsd                       | –     | 0       |
| LALPHA0   | Length dependence of alpha0                      | –     | 0       |
| LALPHA1   | Length dependence of alpha1                      | –     | 0       |
| LAT       | Length dependence of at                          | –     | 0       |
| LB0       | Length dependence of b0                          | –     | 0       |
| LB1       | Length dependence of b1                          | –     | 0       |
| LBETA0    | Length dependence of beta0                       | –     | 0       |
| LBGIDL    | Length dependence of bgidl                       | –     | 0       |
| LBGISL    | Length dependence of bgisl                       | –     | 0       |
| LBIGBACC  | Length dependence of bigbacc                     | –     | 0       |
| LBIGBINV  | Length dependence of bigbinv                     | –     | 0       |
| LBIGC     | Length dependence of bigc                        | –     | 0       |
| LBIGD     | Length dependence of bigd                        | –     | 0       |
| LBIGS     | Length dependence of bigs                        | –     | 0       |
| LBIGSD    | Length dependence of bigsd                       | –     | 0       |
| LCDSC     | Length dependence of cdsc                        | –     | 0       |
| LCDS CB   | Length dependence of cds cb                      | –     | 0       |

| Parameter | Description                  | Units | Default |
|-----------|------------------------------|-------|---------|
| LCDSCD    | Length dependence of cdsd    | –     | 0       |
| LCF       | Length dependence of cf      | –     | 0       |
| LCGDL     | Length dependence of cgdl    | –     | 0       |
| LCGIDL    | Length dependence of cgidl   | –     | 0       |
| LCGISL    | Length dependence of cgisl   | –     | 0       |
| LCGSL     | Length dependence of cgsl    | –     | 0       |
| LCIGBACC  | Length dependence of cigbacc | –     | 0       |
| LCIGBINV  | Length dependence of cigbinv | –     | 0       |
| LCIGC     | Length dependence of cigc    | –     | 0       |
| LCIGD     | Length dependence of cigd    | –     | 0       |
| LCIGS     | Length dependence of cigs    | –     | 0       |
| LCIGSD    | Length dependence of cigsd   | –     | 0       |
| LCIT      | Length dependence of cit     | –     | 0       |
| LCKAPPAD  | Length dependence of ckappad | –     | 0       |
| LCKAPPAS  | Length dependence of ckappas | –     | 0       |
| LCLC      | Length dependence of clc     | –     | 0       |
| LCLE      | Length dependence of cle     | –     | 0       |
| LDELTA    | Length dependence of delta   | –     | 0       |
| LDROUT    | Length dependence of drout   | –     | 0       |
| LDSUB     | Length dependence of dsub    | –     | 0       |
| LDVTO     | Length dependence of dvt0    | –     | 0       |
| LDVT0W    | Length dependence of dvt0w   | –     | 0       |
| LDVT1     | Length dependence of dvt1    | –     | 0       |
| LDVT1W    | Length dependence of dvt1w   | –     | 0       |
| LDVT2     | Length dependence of dvt2    | –     | 0       |
| LDVT2W    | Length dependence of dvt2w   | –     | 0       |
| LDVTP0    | Length dependence of dvtp0   | –     | 0       |
| LDVTP1    | Length dependence of dvtp1   | –     | 0       |
| LDWB      | Length dependence of dwb     | –     | 0       |
| LDWG      | Length dependence of dwg     | –     | 0       |

| Parameter | Description                         | Units | Default |
|-----------|-------------------------------------|-------|---------|
| LEGIDL    | Length dependence of egidl          | –     | 0       |
| LEGISL    | Length dependence of egisl          | –     | 0       |
| LEIGBINV  | Length dependence for eigbinv       | –     | 0       |
| LETAO     | Length dependence of eta0           | –     | 0       |
| LETAB     | Length dependence of etab           | –     | 0       |
| LEU       | Length dependence of eu             | –     | 0       |
| LFPROUT   | Length dependence of pdiblcb        | –     | 0       |
| LGAMMA1   | Length dependence of gamma1         | –     | 0       |
| LGAMMA2   | Length dependence of gamma2         | –     | 0       |
| LINTNOI   | lint offset for noise calculation   | –     | 0       |
| LK1       | Length dependence of k1             | –     | 0       |
| LK2       | Length dependence of k2             | –     | 0       |
| LK2WE     | Length dependence of k2we           | –     | 0       |
| LK3       | Length dependence of k3             | –     | 0       |
| LK3B      | Length dependence of k3b            | –     | 0       |
| LKETA     | Length dependence of keta           | –     | 0       |
| LKT1      | Length dependence of kt1            | –     | 0       |
| LKT1L     | Length dependence of kt1l           | –     | 0       |
| LKT2      | Length dependence of kt2            | –     | 0       |
| LKU0      | Length dependence of ku0            | –     | 0       |
| LKU0WE    | Length dependence of ku0we          | –     | 0       |
| LKVTH0    | Length dependence of kvth0          | –     | 0       |
| LKVTH0WE  | Length dependence of kvth0we        | –     | 0       |
| LL        | Length reduction parameter          | –     | 0       |
| LLAMBDA   | Length dependence of lambda         | –     | 0       |
| LLC       | Length reduction parameter for CV   | –     | 0       |
| LLN       | Length reduction parameter          | –     | 1       |
| LLODKU0   | Length parameter for u0 LOD effect  | –     | 0       |
| LLODVTH   | Length parameter for vth LOD effect | –     | 0       |
| LLP       | Length dependence of lp             | –     | 0       |



| Parameter | Description                                      | Units | Default |
|-----------|--|-------|---------|
| LLPEO     | Length dependence of lpe0                        | –     | 0       |
| LLPEB     | Length dependence of lpeb                        | –     | 0       |
| LMAX      | Maximum length for the model                     | –     | 1       |
| LMIN      | Minimum length for the model                     | –     | 0       |
| LMINV     | Length dependence of minv                        | –     | 0       |
| LMINVCV   | Length dependence of minvcv                      | –     | 0       |
| LMOIN     | Length dependence of moin                        | –     | 0       |
| LNDEP     | Length dependence of ndep                        | –     | 0       |
| LNFACTOR  | Length dependence of nfactor                     | –     | 0       |
| LNGATE    | Length dependence of ngate                       | –     | 0       |
| LNIGBACC  | Length dependence of nigbacc                     | –     | 0       |
| LNIGBINV  | Length dependence of nigbinv                     | –     | 0       |
| LNIGC     | Length dependence of nigc                        | –     | 0       |
| LNOFF     | Length dependence of noff                        | –     | 0       |
| LNSD      | Length dependence of nsd                         | –     | 0       |
| LNSUB     | Length dependence of nsub                        | –     | 0       |
| LNTOX     | Length dependence of ntox                        | –     | 0       |
| LODETA0   | eta0 shift modification factor for stress effect | –     | 1       |
| LODK2     | K2 shift modification factor for stress effect   | –     | 1       |
| LPCLM     | Length dependence of pclm                        | –     | 0       |
| LPDIBLC1  | Length dependence of pdiblc1                     | –     | 0       |
| LPDIBLC2  | Length dependence of pdiblc2                     | –     | 0       |
| LPDIBLCB  | Length dependence of pdiblcb                     | –     | 0       |
| LPDITS    | Length dependence of pdits                       | –     | 0       |
| LPDITSD   | Length dependence of pditsd                      | –     | 0       |
| LPHIN     | Length dependence of phin                        | –     | 0       |
| LPIGCD    | Length dependence for pigcd                      | –     | 0       |
| LPOXEDGE  | Length dependence for poxedge                    | –     | 0       |
| LPRT      | Length dependence of prt                         | –     | 0       |
| LPRWB     | Length dependence of prwb                        | –     | 0       |

| Parameter  | Description                    | Units | Default |
|------------|--------------------------------|-------|---------|
| LPRWG      | Length dependence of prwg      | –     | 0       |
| LPSCBE1    | Length dependence of pscbe1    | –     | 0       |
| LPSCBE2    | Length dependence of pscbe2    | –     | 0       |
| LPVAG      | Length dependence of pvag      | –     | 0       |
| LRDSW      | Length dependence of rdsw      | –     | 0       |
| LRDW       | Length dependence of rdw       | –     | 0       |
| LRSW       | Length dependence of rsw       | –     | 0       |
| LTVFBSDOFF | Length dependence of tvfbsdoff | –     | 0       |
| LTVOFF     | Length dependence of tvoff     | –     | 0       |
| LU0        | Length dependence of u0        | –     | 0       |
| LUA        | Length dependence of ua        | –     | 0       |
| LUA1       | Length dependence of ua1       | –     | 0       |
| LUB        | Length dependence of ub        | –     | 0       |
| LUB1       | Length dependence of ub1       | –     | 0       |
| LUC        | Length dependence of uc        | –     | 0       |
| LUC1       | Length dependence of uc1       | –     | 0       |
| LUD        | Length dependence of ud        | –     | 0       |
| LUD1       | Length dependence of ud1       | –     | 0       |
| LUP        | Length dependence of up        | –     | 0       |
| LUTE       | Length dependence of ute       | –     | 0       |
| LVBM       | Length dependence of vbm       | –     | 0       |
| LVBX       | Length dependence of vbx       | –     | 0       |
| LVFB       | Length dependence of vfb       | –     | 0       |
| LVFBCV     | Length dependence of vfbcv     | –     | 0       |
| LVFBSDOFF  | Length dependence of vfbsdoff  | –     | 0       |
| LVOFF      | Length dependence of voff      | –     | 0       |
| LVOFFCV    | Length dependence of voffcv    | –     | 0       |
| LVSAT      | Length dependence of vsat      | –     | 0       |
| LVTHO      |                                | –     | 0       |
| LVTL       | Length dependence of vtl       | –     | 0       |

| Parameter | Description  | Units | Default |
|-----------|--|-------|---------|
| LW        | Length reduction parameter   | –     | 0       |
| LW0       | Length dependence of w0  | –     | 0       |
| LWC       | Length reduction parameter for CV                                    | –     | 0       |
| LWL       | Length reduction parameter   | –     | 0       |
| LWLC      | Length reduction parameter for CV                                    | –     | 0       |
| LWN       | Length reduction parameter   | –     | 1       |
| LWR       | Length dependence of wr  | –     | 0       |
| LXJ       | Length dependence of xj  | –     | 0       |
| LXN       | Length dependence of xn  | –     | 0       |
| LXRCRG1   | Length dependence of xrcrg1  | –     | 0       |
| LXRCRG2   | Length dependence of xrcrg2  | –     | 0       |
| LXT       | Length dependence of xt  | –     | 0       |
| MJD       | Drain bottom junction capacitance grading coefficient                | –     | 0.5     |
| MJS       | Source bottom junction capacitance grading coefficient               | –     | 0.5     |
| MJSWD     | Drain sidewall junction capacitance grading coefficient              | –     | 0.33    |
| MJSWGD    | Drain (gate side) sidewall junction capacitance grading coefficient  | –     | 0.33    |
| MJSWGS    | Source (gate side) sidewall junction capacitance grading coefficient | –     | 0.33    |
| MJSWS     | Source sidewall junction capacitance grading coefficient             | –     | 0.33    |
| NGCON     | Number of gate contacts  | –     | 1       |
| NJD       | Drain junction emission coefficient                                  | –     | 1       |
| NJS       | Source junction emission coefficient                                 | –     | 1       |
| NJTS      | Non-ideality factor for bottom junction                              | –     | 20      |
| NJTSD     | Non-ideality factor for bottom junction drain side                   | –     | 20      |
| NJTSSW    | Non-ideality factor for STI sidewall junction                        | –     | 20      |
| NJTSSWD   | Non-ideality factor for STI sidewall junction drain side             | –     | 20      |
| NJTSSWG   | Non-ideality factor for gate-edge sidewall junction                  | –     | 20      |
| NJTSSWGD  | Non-ideality factor for gate-edge sidewall junction drain side       | –     | 20      |
| NTNOI     | Thermal noise parameter  | –     | 1       |

| Parameter | Description  | Units | Default |
|-----------|--|-------|---------|
| PA0       | Cross-term dependence of a0                            | –     | 0       |
| PA1       | Cross-term dependence of a1                            | –     | 0       |
| PA2       | Cross-term dependence of a2                            | –     | 0       |
| PACDE     | Cross-term dependence of acde                          | –     | 0       |
| PAGIDL    | Cross-term dependence of agidl                         | –     | 0       |
| PAGISL    | Cross-term dependence of agisl                         | –     | 0       |
| PAGS      | Cross-term dependence of ags                           | –     | 0       |
| PAIGBACC  | Cross-term dependence of aigbacc                       | –     | 0       |
| PAIGBINV  | Cross-term dependence of aigbinv                       | –     | 0       |
| PAIGC     | Cross-term dependence of aigc                          | –     | 0       |
| PAIGD     | Cross-term dependence of aigd                          | –     | 0       |
| PAIGS     | Cross-term dependence of aigs                          | –     | 0       |
| PAIGSD    | Cross-term dependence of aigsd                         | –     | 0       |
| PALPHA0   | Cross-term dependence of alpha0                        | –     | 0       |
| PALPHA1   | Cross-term dependence of alpha1                        | –     | 0       |
| PAT       | Cross-term dependence of at                            | –     | 0       |
| PB0       | Cross-term dependence of b0                            | –     | 0       |
| PB1       | Cross-term dependence of b1                            | –     | 0       |
| PBD       | Drain junction built-in potential                      | –     | 1       |
| PBETA0    | Cross-term dependence of beta0                         | –     | 0       |
| PBGIDL    | Cross-term dependence of bgidl                         | –     | 0       |
| PBGISL    | Cross-term dependence of bgisl                         | –     | 0       |
| PBIGBACC  | Cross-term dependence of bigbacc                       | –     | 0       |
| PBIGBINV  | Cross-term dependence of bigbinv                       | –     | 0       |
| PBIGC     | Cross-term dependence of bigc                          | –     | 0       |
| PBIGD     | Cross-term dependence of bigd                          | –     | 0       |
| PBIGS     | Cross-term dependence of bigs                          | –     | 0       |
| PBIGSD    | Cross-term dependence of bigsd                         | –     | 0       |
| PBS       | Source junction built-in potential                     | –     | 1       |
| PBSWD     | Drain sidewall junction capacitance built in potential | –     | 1       |

| Parameter | Description   | Units | Default |
|-----------|---|-------|---------|
| PBSWGD    | Drain (gate side) sidewall junction capacitance built in potential  | –     | 1       |
| PBSWGS    | Source (gate side) sidewall junction capacitance built in potential | –     | 1       |
| PBSWS     | Source sidewall junction capacitance built in potential             | –     | 1       |
| PCDSC     | Cross-term dependence of cdsc                                       | –     | 0       |
| PCDSCB    | Cross-term dependence of cdscb                                      | –     | 0       |
| PCDSCD    | Cross-term dependence of cdsd                                       | –     | 0       |
| PCF       | Cross-term dependence of cf   | –     | 0       |
| PCGDL     | Cross-term dependence of cgdl                                       | –     | 0       |
| PCGIDL    | Cross-term dependence of cgidl                                      | –     | 0       |
| PCGISL    | Cross-term dependence of cgisl                                      | –     | 0       |
| PCGSL     | Cross-term dependence of cgsl                                       | –     | 0       |
| PCIGBACC  | Cross-term dependence of cigbacc                                    | –     | 0       |
| PCIGBINV  | Cross-term dependence of cigbinv                                    | –     | 0       |
| PCIGC     | Cross-term dependence of cigc                                       | –     | 0       |
| PCIGD     | Cross-term dependence of cigd                                       | –     | 0       |
| PCIGS     | Cross-term dependence of cigs                                       | –     | 0       |
| PCIGSD    | Cross-term dependence of cigsd                                      | –     | 0       |
| PCIT      | Cross-term dependence of cit  | –     | 0       |
| PCKAPPAD  | Cross-term dependence of ckappad                                    | –     | 0       |
| PCKAPPAS  | Cross-term dependence of ckappas                                    | –     | 0       |
| PCLC      | Cross-term dependence of clc  | –     | 0       |
| PCLE      | Cross-term dependence of cle  | –     | 0       |
| PDELTA    | Cross-term dependence of delta                                      | –     | 0       |
| PDROUT    | Cross-term dependence of drout                                      | –     | 0       |
| PDSUB     | Cross-term dependence of dsub                                       | –     | 0       |
| PDVT0     | Cross-term dependence of dvt0                                       | –     | 0       |
| PDVT0w    | Cross-term dependence of dvt0w                                      | –     | 0       |
| PDVT1     | Cross-term dependence of dvt1                                       | –     | 0       |
| PDVT1w    | Cross-term dependence of dvt1w                                      | –     | 0       |

| Parameter | Description                       | Units | Default |
|-----------|-----------------------------------|-------|---------|
| PDVT2     | Cross-term dependence of dvt2     | –     | 0       |
| PDVT2W    | Cross-term dependence of dvt2w    | –     | 0       |
| PDVTP0    | Cross-term dependence of dvtp0    | –     | 0       |
| PDVTP1    | Cross-term dependence of dvtp1    | –     | 0       |
| PDWB      | Cross-term dependence of dwb      | –     | 0       |
| PDWG      | Cross-term dependence of dwg      | –     | 0       |
| PEGIDL    | Cross-term dependence of egidl    | –     | 0       |
| PEGISL    | Cross-term dependence of egisl    | –     | 0       |
| PEIGBINV  | Cross-term dependence for eigbinv | –     | 0       |
| PETA0     | Cross-term dependence of eta0     | –     | 0       |
| PETAB     | Cross-term dependence of etab     | –     | 0       |
| PEU       | Cross-term dependence of eu       | –     | 0       |
| PFPROUT   | Cross-term dependence of pdiblcb  | –     | 0       |
| PGAMMA1   | Cross-term dependence of gamma1   | –     | 0       |
| PGAMMA2   | Cross-term dependence of gamma2   | –     | 0       |
| PHIG      | Work Function of gate             | –     | 4.05    |
| PK1       | Cross-term dependence of k1       | –     | 0       |
| PK2       | Cross-term dependence of k2       | –     | 0       |
| PK2WE     | Cross-term dependence of k2we     | –     | 0       |
| PK3       | Cross-term dependence of k3       | –     | 0       |
| PK3B      | Cross-term dependence of k3b      | –     | 0       |
| PKETA     | Cross-term dependence of keta     | –     | 0       |
| PKT1      | Cross-term dependence of kt1      | –     | 0       |
| PKT1L     | Cross-term dependence of kt1l     | –     | 0       |
| PKT2      | Cross-term dependence of kt2      | –     | 0       |
| PKU0      | Cross-term dependence of ku0      | –     | 0       |
| PKUOWE    | Cross-term dependence of ku0we    | –     | 0       |
| PKVTH0    | Cross-term dependence of kvth0    | –     | 0       |
| PKVTHOWE  | Cross-term dependence of kvth0we  | –     | 0       |
| PLAMBDA   | Cross-term dependence of lambda   | –     | 0       |

| Parameter | Description                       | Units | Default |
|-----------|-----------------------------------|-------|---------|
| PLP       | Cross-term dependence of lp       | –     | 0       |
| PLPEO     | Cross-term dependence of lpe0     | –     | 0       |
| PLPEB     | Cross-term dependence of lpeb     | –     | 0       |
| PMINV     | Cross-term dependence of minv     | –     | 0       |
| PMINVCV   | Cross-term dependence of minvcv   | –     | 0       |
| PMOIN     | Cross-term dependence of moin     | –     | 0       |
| PNDEP     | Cross-term dependence of ndep     | –     | 0       |
| PNFACTOR  | Cross-term dependence of nfactor  | –     | 0       |
| PNGATE    | Cross-term dependence of ngate    | –     | 0       |
| PNIGBACC  | Cross-term dependence of nigbacc  | –     | 0       |
| PNIGBINV  | Cross-term dependence of nigbinv  | –     | 0       |
| PNIGC     | Cross-term dependence of nigc     | –     | 0       |
| PNOFF     | Cross-term dependence of noff     | –     | 0       |
| PNSD      | Cross-term dependence of nsd      | –     | 0       |
| PNSUB     | Cross-term dependence of nsub     | –     | 0       |
| PNTOX     | Cross-term dependence of ntox     | –     | 0       |
| PPCLM     | Cross-term dependence of pclm     | –     | 0       |
| PPDIBLC1  | Cross-term dependence of pdiblc1  | –     | 0       |
| PPDIBLC2  | Cross-term dependence of pdiblc2  | –     | 0       |
| PPDIBLCB  | Cross-term dependence of pdiblcb  | –     | 0       |
| PPDITS    | Cross-term dependence of pdits    | –     | 0       |
| PPDITSD   | Cross-term dependence of pditsd   | –     | 0       |
| PPHIN     | Cross-term dependence of phin     | –     | 0       |
| PPIGCD    | Cross-term dependence for pigcd   | –     | 0       |
| PPOXEDGE  | Cross-term dependence for poxedge | –     | 0       |
| PPRT      | Cross-term dependence of prt      | –     | 0       |
| PPRWB     | Cross-term dependence of prwb     | –     | 0       |
| PPRWG     | Cross-term dependence of prwg     | –     | 0       |
| PPSCBE1   | Cross-term dependence of psbbe1   | –     | 0       |
| PPSCBE2   | Cross-term dependence of psbbe2   | –     | 0       |

| Parameter  | Description                                     | Units | Default |
|------------|---|-------|---------|
| PPVAG      | Cross-term dependence of pvag                   | –     | 0       |
| PRDSW      | Cross-term dependence of rdsw                   | –     | 0       |
| PRDW       | Cross-term dependence of rdw                    | –     | 0       |
| PRSW       | Cross-term dependence of rsw                    | –     | 0       |
| PRT        | Temperature coefficient of parasitic resistance | –     | 0       |
| PTVFBSDOFF | Cross-term dependence of tvfbsdoff              | –     | 0       |
| PTVOFF     | Cross-term dependence of tvoff                  | –     | 0       |
| PU0        | Cross-term dependence of u0                     | –     | 0       |
| PUA        | Cross-term dependence of ua                     | –     | 0       |
| PUA1       | Cross-term dependence of ua1                    | –     | 0       |
| PUB        | Cross-term dependence of ub                     | –     | 0       |
| PUB1       | Cross-term dependence of ub1                    | –     | 0       |
| PUC        | Cross-term dependence of uc                     | –     | 0       |
| PUC1       | Cross-term dependence of uc1                    | –     | 0       |
| PUD        | Cross-term dependence of ud                     | –     | 0       |
| PUD1       | Cross-term dependence of ud1                    | –     | 0       |
| PUP        | Cross-term dependence of up                     | –     | 0       |
| PUTE       | Cross-term dependence of ute                    | –     | 0       |
| PVAG       | Gate dependence of output resistance parameter  | –     | 0       |
| PVBM       | Cross-term dependence of vbm                    | –     | 0       |
| PVBX       | Cross-term dependence of vbx                    | –     | 0       |
| PVFB       | Cross-term dependence of vfb                    | –     | 0       |
| PVFBCV     | Cross-term dependence of vfbcv                  | –     | 0       |
| PVFBSDOFF  | Cross-term dependence of vfbsdoff               | –     | 0       |
| PVOFF      | Cross-term dependence of voff                   | –     | 0       |
| PVOFFCV    | Cross-term dependence of voffcv                 | –     | 0       |
| PVSAT      | Cross-term dependence of vsat                   | –     | 0       |
| PVTH0      |   | –     | 0       |
| PVTL       | Cross-term dependence of vtl                    | –     | 0       |
| PW0        | Cross-term dependence of w0                     | –     | 0       |



| Parameter | Description                              | Units    | Default |
|-----------|--|----------|---------|
| PWR       | Cross-term dependence of wr              | –        | 0       |
| PXJ       | Cross-term dependence of xj              | –        | 0       |
| PXN       | Cross-term dependence of xn              | –        | 0       |
| PXRCRG1   | Cross-term dependence of xrcrg1          | –        | 0       |
| PXRCRG2   | Cross-term dependence of xrcrg2          | –        | 0       |
| PXT       | Cross-term dependence of xt              | –        | 0       |
| RBDB      | Resistance between bNode and dbNode      | $\Omega$ | 50      |
| RBDBX0    | Body resistance RBDBX scaling            | –        | 100     |
| RBDBY0    | Body resistance RBDBY scaling            | –        | 100     |
| RBPB      | Resistance between bNodePrime and bNode  | $\Omega$ | 50      |
| RBPBX0    | Body resistance RBPBX scaling            | –        | 100     |
| RBPBXL    | Body resistance RBPBX L scaling          | –        | 0       |
| RBPBXNF   | Body resistance RBPBX NF scaling         | –        | 0       |
| RBPBXW    | Body resistance RBPBX W scaling          | –        | 0       |
| RBPBY0    | Body resistance RBPBY scaling            | –        | 100     |
| RBPBYL    | Body resistance RBPBY L scaling          | –        | 0       |
| RBPBYNF   | Body resistance RBPBY NF scaling         | –        | 0       |
| RBPBYW    | Body resistance RBPBY W scaling          | –        | 0       |
| RBPD      | Resistance between bNodePrime and bNode  | $\Omega$ | 50      |
| RBPDO     | Body resistance RBPDO scaling            | –        | 50      |
| RBPDL     | Body resistance RBPDO L scaling          | –        | 0       |
| RBPDNF    | Body resistance RBPDO NF scaling         | –        | 0       |
| RBPDW     | Body resistance RBPDO W scaling          | –        | 0       |
| RBPS      | Resistance between bNodePrime and sbNode | $\Omega$ | 50      |
| RBPS0     | Body resistance RBPS scaling             | –        | 50      |
| RBPSL     | Body resistance RBPS L scaling           | –        | 0       |
| RBPSNF    | Body resistance RBPS NF scaling          | –        | 0       |
| RBPSW     | Body resistance RBPS W scaling           | –        | 0       |
| RBSB      | Resistance between bNode and sbNode      | $\Omega$ | 50      |
| RBSBX0    | Body resistance RBSBX scaling            | –        | 100     |

| Parameter | Description  | Units | Default |
|-----------|--|-------|---------|
| RBSBY0    | Body resistance RBSBY scaling                                | –     | 100     |
| RBSDBXL   | Body resistance RBSDBX L scaling                             | –     | 0       |
| RBSDBXNF  | Body resistance RBSDBX NF scaling                            | –     | 0       |
| RBSDBXW   | Body resistance RBSDBX W scaling                             | –     | 0       |
| RBSDBYL   | Body resistance RBSDBY L scaling                             | –     | 0       |
| RBSDBYNF  | Body resistance RBSDBY NF scaling                            | –     | 0       |
| RBSDBYW   | Body resistance RBSDBY W scaling                             | –     | 0       |
| RNOIA     | Thermal noise coefficient                                    | –     | 0.577   |
| RNOIB     | Thermal noise coefficient                                    | –     | 0.5164  |
| SAREF     | Reference distance between OD edge to poly of one side       | –     | 1e-06   |
| SBREF     | Reference distance between OD edge to poly of the other side | –     | 1e-06   |
| SCREF     | Reference distance to calculate SCA, SCB and SCC             | –     | 1e-06   |
| STETA0    | eta0 shift factor related to stress effect on vth            | –     | 0       |
| STK2      | K2 shift factor related to stress effect on vth              | –     | 0       |
| TCJ       | Temperature coefficient of cj                                | –     | 0       |
| TCJSW     | Temperature coefficient of cjsw                              | –     | 0       |
| TCJSWG    | Temperature coefficient of cjswg                             | –     | 0       |
| TKU0      | Temperature coefficient of KU0                               | –     | 0       |
| TNJTS     | Temperature coefficient for NJTS                             | –     | 0       |
| TNJTSD    | Temperature coefficient for NJTSD                            | –     | 0       |
| TNJTSSW   | Temperature coefficient for NJTSSW                           | –     | 0       |
| TNJTSSWD  | Temperature coefficient for NJTSSWD                          | –     | 0       |
| TNJTSSWG  | Temperature coefficient for NJTSSWG                          | –     | 0       |
| TNJTSSWGD | Temperature coefficient for NJTSSWGD                         | –     | 0       |
| TNOIA     | Thermal noise parameter                                      | –     | 1.5     |
| TNOIB     | Thermal noise parameter                                      | –     | 3.5     |
| TNOM      | Parameter measurement temperature                            | –     | 27      |
| TPB       | Temperature coefficient of pb                                | –     | 0       |
| TPBSW     | Temperature coefficient of pbsw                              | –     | 0       |

| Parameter | Description   | Units | Default  |
|-----------|---|-------|----------|
| TPBSWG    | Temperature coefficient of pbswg                                    | –     | 0        |
| TVFBSDOFF | Temperature parameter for vfbsdoff                                  | –     | 0        |
| TVOFF     | Temperature parameter for voff                                      | –     | 0        |
| UA1       | Temperature coefficient of ua                                       | –     | 1e-09    |
| UB1       | Temperature coefficient of ub                                       | –     | -1e-18   |
| UC1       | Temperature coefficient of uc                                       | –     | -5.6e-11 |
| UD1       | Temperature coefficient of ud                                       | –     | 0        |
| UTE       | Temperature coefficient of mobility                                 | –     | -1.5     |
| VTSD      | Drain bottom trap-assisted voltage dependent parameter              | –     | 10       |
| VTSS      | Source bottom trap-assisted voltage dependent parameter             | –     | 10       |
| VTSSWD    | Drain STI sidewall trap-assisted voltage dependent parameter        | –     | 10       |
| VTSSWGD   | Drain gate-edge sidewall trap-assisted voltage dependent parameter  | –     | 10       |
| VTSSWGS   | Source gate-edge sidewall trap-assisted voltage dependent parameter | –     | 10       |
| VTSSWS    | Source STI sidewall trap-assisted voltage dependent parameter       | –     | 10       |
| WA0       | Width dependence of a0  | –     | 0        |
| WA1       | Width dependence of a1  | –     | 0        |
| WA2       | Width dependence of a2  | –     | 0        |
| WACDE     | Width dependence of acde  | –     | 0        |
| WAGIDL    | Width dependence of agidl   | –     | 0        |
| WAGISL    | Width dependence of agisl   | –     | 0        |
| WAGS      | Width dependence of ags   | –     | 0        |
| WAIGBACC  | Width dependence of aigbacc   | –     | 0        |
| WAIGBINV  | Width dependence of aigbinv   | –     | 0        |
| WAIGC     | Width dependence of aigc  | –     | 0        |
| WAIGD     | Width dependence of aigd  | –     | 0        |
| WAIGS     | Width dependence of aigs  | –     | 0        |
| WAIGSD    | Width dependence of aigsd   | –     | 0        |

| Parameter | Description                 | Units | Default |
|-----------|-----------------------------|-------|---------|
| WALPHA0   | Width dependence of alpha0  | –     | 0       |
| WALPHA1   | Width dependence of alpha1  | –     | 0       |
| WAT       | Width dependence of at      | –     | 0       |
| WB0       | Width dependence of b0      | –     | 0       |
| WB1       | Width dependence of b1      | –     | 0       |
| WBETA0    | Width dependence of beta0   | –     | 0       |
| WBGIDL    | Width dependence of bgidl   | –     | 0       |
| WBGISL    | Width dependence of bgisl   | –     | 0       |
| WBIGBACC  | Width dependence of bigbacc | –     | 0       |
| WBIGBINV  | Width dependence of bigbinv | –     | 0       |
| WBIGC     | Width dependence of bigc    | –     | 0       |
| WBIGD     | Width dependence of bigd    | –     | 0       |
| WBIGS     | Width dependence of bigs    | –     | 0       |
| WBIGSD    | Width dependence of bigsd   | –     | 0       |
| WCDS      | Width dependence of cdsc    | –     | 0       |
| WCDSB     | Width dependence of cdsb    | –     | 0       |
| WCSD      | Width dependence of cdsd    | –     | 0       |
| WCF       | Width dependence of cf      | –     | 0       |
| WCGDL     | Width dependence of cgdl    | –     | 0       |
| WCGIDL    | Width dependence of cgidl   | –     | 0       |
| WCGISL    | Width dependence of cgisl   | –     | 0       |
| WCGSL     | Width dependence of cgsl    | –     | 0       |
| WCIGBACC  | Width dependence of cigbacc | –     | 0       |
| WCIGBINV  | Width dependence of cigbinv | –     | 0       |
| WCIGC     | Width dependence of cigc    | –     | 0       |
| WCIGD     | Width dependence of cigd    | –     | 0       |
| WCIGS     | Width dependence of cigs    | –     | 0       |
| WCIGSD    | Width dependence of cigsd   | –     | 0       |
| WCIT      | Width dependence of cit     | –     | 0       |
| WCKAPPAD  | Width dependence of ckappad | –     | 0       |

| Parameter | Description                  | Units | Default |
|-----------|------------------------------|-------|---------|
| WCKAPPAS  | Width dependence of ckappas  | –     | 0       |
| WCLC      | Width dependence of clc      | –     | 0       |
| WCLE      | Width dependence of cle      | –     | 0       |
| WDELTA    | Width dependence of delta    | –     | 0       |
| WDROUT    | Width dependence of drout    | –     | 0       |
| WDSUB     | Width dependence of dsub     | –     | 0       |
| WDVT0     | Width dependence of dvt0     | –     | 0       |
| WDVT0W    | Width dependence of dvt0w    | –     | 0       |
| WDVT1     | Width dependence of dvt1     | –     | 0       |
| WDVT1W    | Width dependence of dvt1w    | –     | 0       |
| WDVT2     | Width dependence of dvt2     | –     | 0       |
| WDVT2W    | Width dependence of dvt2w    | –     | 0       |
| WDVTP0    | Width dependence of dvtp0    | –     | 0       |
| WDVTP1    | Width dependence of dvtp1    | –     | 0       |
| WDWB      | Width dependence of dwb      | –     | 0       |
| WDWG      | Width dependence of dwg      | –     | 0       |
| WEB       | Coefficient for SCB          | –     | 0       |
| WEC       | Coefficient for SCC          | –     | 0       |
| WEGIDL    | Width dependence of egidl    | –     | 0       |
| WEGISL    | Width dependence of egisl    | –     | 0       |
| WEIGBINV  | Width dependence for eigbinv | –     | 0       |
| WETA0     | Width dependence of eta0     | –     | 0       |
| WETAB     | Width dependence of etab     | –     | 0       |
| WEU       | Width dependence of eu       | –     | 0       |
| WFPROUT   | Width dependence of pdiblcb  | –     | 0       |
| WGAMMA1   | Width dependence of gamma1   | –     | 0       |
| WGAMMA2   | Width dependence of gamma2   | –     | 0       |
| WK1       | Width dependence of k1       | –     | 0       |
| WK2       | Width dependence of k2       | –     | 0       |
| WK2WE     | Width dependence of k2we     | –     | 0       |

| Parameter | Description                        | Units | Default |
|-----------|------------------------------------|-------|---------|
| WK3       | Width dependence of k3             | –     | 0       |
| WK3B      | Width dependence of k3b            | –     | 0       |
| WKETA     | Width dependence of keta           | –     | 0       |
| WKT1      | Width dependence of kt1            | –     | 0       |
| WKT1L     | Width dependence of kt1l           | –     | 0       |
| WKT2      | Width dependence of kt2            | –     | 0       |
| WKU0      | Width dependence of ku0            | –     | 0       |
| WKUOWE    | Width dependence of ku0we          | –     | 0       |
| WKVTH0    | Width dependence of kvth0          | –     | 0       |
| WKVTHOWE  | Width dependence of kvth0we        | –     | 0       |
| WL        | Width reduction parameter          | –     | 0       |
| WLAMBDA   | Width dependence of lambda         | –     | 0       |
| WLC       | Width reduction parameter for CV   | –     | 0       |
| WLN       | Width reduction parameter          | –     | 1       |
| WLOD      | Width parameter for stress effect  | –     | 0       |
| WLODKU0   | Width parameter for u0 LOD effect  | –     | 0       |
| WLODVTH   | Width parameter for vth LOD effect | –     | 0       |
| WLP       | Width dependence of lp             | –     | 0       |
| WLPE0     | Width dependence of lpe0           | –     | 0       |
| WLPEB     | Width dependence of lpeb           | –     | 0       |
| WMAX      | Maximum width for the model        | –     | 1       |
| WMIN      | Minimum width for the model        | –     | 0       |
| WMINV     | Width dependence of minv           | –     | 0       |
| WMINVCV   | Width dependence of minvcv         | –     | 0       |
| WMOIN     | Width dependence of moin           | –     | 0       |
| WNDEP     | Width dependence of ndep           | –     | 0       |
| WNFACTOR  | Width dependence of nfactor        | –     | 0       |
| WNGATE    | Width dependence of ngate          | –     | 0       |
| WNIGBACC  | Width dependence of nigbacc        | –     | 0       |
| WNIGBINV  | Width dependence of nigbinv        | –     | 0       |

| Parameter  | Description  | Units | Default |
|------------|--|-------|---------|
| WNIGC      | Width dependence of nigc                             | –     | 0       |
| WNOFF      | Width dependence of noff                             | –     | 0       |
| WNSD       | Width dependence of nsd                              | –     | 0       |
| WNSUB      | Width dependence of nsub                             | –     | 0       |
| WNTOX      | Width dependence of ntox                             | –     | 0       |
| WPCLM      | Width dependence of pclm                             | –     | 0       |
| WPDIBLC1   | Width dependence of pdiblc1                          | –     | 0       |
| WPDIBLC2   | Width dependence of pdiblc2                          | –     | 0       |
| WPDIBLCB   | Width dependence of pdiblcb                          | –     | 0       |
| WPDITS     | Width dependence of pdits                            | –     | 0       |
| WPDITSD    | Width dependence of pditsd                           | –     | 0       |
| WPEMOD     | Flag for WPE model (WPEMOD=1 to activate this model) | –     | 0       |
| WPHIN      | Width dependence of phin                             | –     | 0       |
| WPIGCD     | Width dependence for pigcd                           | –     | 0       |
| WPOXEDGE   | Width dependence for poxedge                         | –     | 0       |
| WPRT       | Width dependence of prt                              | –     | 0       |
| WPRWB      | Width dependence of prwb                             | –     | 0       |
| WPRWG      | Width dependence of prwg                             | –     | 0       |
| WPSCBE1    | Width dependence of pscbe1                           | –     | 0       |
| WPSCBE2    | Width dependence of pscbe2                           | –     | 0       |
| WPVAG      | Width dependence of pvag                             | –     | 0       |
| WRDSW      | Width dependence of rdsw                             | –     | 0       |
| WRDW       | Width dependence of rdw                              | –     | 0       |
| WRSW       | Width dependence of rsw                              | –     | 0       |
| WTVFBSDOFF | Width dependence of tvfbsdoff                        | –     | 0       |
| WTVOFF     | Width dependence of tvoff                            | –     | 0       |
| WU0        | Width dependence of u0                               | –     | 0       |
| WUA        | Width dependence of ua                               | –     | 0       |
| WUA1       | Width dependence of ua1                              | –     | 0       |

| Parameter | Description                      | Units | Default |
|-----------|----------------------------------|-------|---------|
| WUB       | Width dependence of ub           | –     | 0       |
| WUB1      | Width dependence of ub1          | –     | 0       |
| WUC       | Width dependence of uc           | –     | 0       |
| WUC1      | Width dependence of uc1          | –     | 0       |
| WUD       | Width dependence of ud           | –     | 0       |
| WUD1      | Width dependence of ud1          | –     | 0       |
| WUP       | Width dependence of up           | –     | 0       |
| WUTE      | Width dependence of ute          | –     | 0       |
| WVBM      | Width dependence of vbm          | –     | 0       |
| WVBX      | Width dependence of vbX          | –     | 0       |
| WVFB      | Width dependence of vfb          | –     | 0       |
| WVFCV     | Width dependence of vfbcv        | –     | 0       |
| WFBSDOFF  | Width dependence of vfbsdoff     | –     | 0       |
| WVOFF     | Width dependence of voff         | –     | 0       |
| WVOFCV    | Width dependence of voffcv       | –     | 0       |
| WVSAT     | Width dependence of vsat         | –     | 0       |
| WVTHO     |                                  | –     | 0       |
| WVTL      | Width dependence of vtl          | –     | 0       |
| WW        | Width reduction parameter        | –     | 0       |
| WWO       | Width dependence of w0           | –     | 0       |
| WWC       | Width reduction parameter for CV | –     | 0       |
| WWL       | Width reduction parameter        | –     | 0       |
| WWLC      | Width reduction parameter for CV | –     | 0       |
| WWN       | Width reduction parameter        | –     | 1       |
| WWR       | Width dependence of wr           | –     | 0       |
| WXJ       | Width dependence of xj           | –     | 0       |
| WXN       | Width dependence of xn           | –     | 0       |
| WXRCRG1   | Width dependence of xrcrg1       | –     | 0       |
| WXRCRG2   | Width dependence of xrcrg2       | –     | 0       |
| WXT       | Width dependence of xt           | –     | 0       |



| Parameter               | Description  | Units                | Default |
|-------------------------|--|----------------------|---------|
| XGL                     | Variation in Ldrawn                                  | –                    | 0       |
| XGW                     | Distance from gate contact center to device edge     | –                    | 0       |
| XJBVD                   | Fitting parameter for drain diode breakdown current  | –                    | 1       |
| XJBVS                   | Fitting parameter for source diode breakdown current | –                    | 1       |
| XL                      | L offset for channel length due to mask/etch effect  | –                    | 0       |
| XRCRG1                  | First fitting parameter the bias-dependent Rg        | –                    | 12      |
| XRCRG2                  | Second fitting parameter the bias-dependent Rg       | –                    | 1       |
| XTID                    | Drainjunction current temperature exponent           | –                    | 3       |
| XTIS                    | Source junction current temperature exponent         | –                    | 3       |
| XTSD                    | Power dependence of JTSD on temperature              | –                    | 0.02    |
| XTSS                    | Power dependence of JTSS on temperature              | –                    | 0.02    |
| XTSSWD                  | Power dependence of JTSSWD on temperature            | –                    | 0.02    |
| XTSSWGD                 | Power dependence of JTSSWGD on temperature           | –                    | 0.02    |
| XTSSWGS                 | Power dependence of JTSSWGS on temperature           | –                    | 0.02    |
| XTSSWS                  | Power dependence of JTSSWS on temperature            | –                    | 0.02    |
| XW                      | W offset for channel width due to mask/etch effect   | –                    | 0       |
| <b>Basic Parameters</b> |  |                      |         |
| A0                      | Non-uniform depletion width effect coefficient.      | –                    | 1       |
| A1                      | Non-saturation effect coefficient                    | V <sup>-1</sup>      | 0       |
| A2                      | Non-saturation effect coefficient                    | –                    | 1       |
| ADOS                    | Charge centroid parameter                            | –                    | 1       |
| AGS                     | Gate bias coefficient of Abulk.                      | V <sup>-1</sup>      | 0       |
| B0                      | Abulk narrow width parameter                         | m                    | 0       |
| B1                      | Abulk narrow width parameter                         | m                    | 0       |
| BDOS                    | Charge centroid parameter                            | –                    | 1       |
| BGOSUB                  | Band-gap of substrate at T=0K                        | eV                   | 1.16    |
| CDSC                    | Drain/Source and channel coupling capacitance        | F/m <sup>2</sup>     | 0.00024 |
| CDSCB                   | Body-bias dependence of cdsc                         | F/(Vm <sup>2</sup> ) | 0       |
| CDSCD                   | Drain-bias dependence of cdsc                        | F/(Vm <sup>2</sup> ) | 0       |
| CIT                     | Interface state capacitance                          | F/m <sup>2</sup>     | 0       |

| Parameter | Description  | Units              | Default  |
|-----------|--|--------------------|----------|
| DELTA     | Effective Vds parameter                                      | V                  | 0.01     |
| DROUT     | DIBL coefficient of output resistance                        | –                  | 0.56     |
| DSUB      | DIBL coefficient in the subthreshold region                  | –                  | 0.56     |
| DVT0      | Short channel effect coeff. 0                                | –                  | 2.2      |
| DVT0W     | Narrow Width coeff. 0  | –                  | 0        |
| DVT1      | Short channel effect coeff. 1                                | –                  | 0.53     |
| DVT1W     | Narrow Width effect coeff. 1                                 | m <sup>-1</sup>    | 5.3e+06  |
| DVT2      | Short channel effect coeff. 2                                | V <sup>-1</sup>    | -0.032   |
| DVT2W     | Narrow Width effect coeff. 2                                 | V <sup>-1</sup>    | -0.032   |
| DVTPO     | First parameter for Vth shift due to pocket                  | m                  | 0        |
| DVTP1     | Second parameter for Vth shift due to pocket                 | V <sup>-1</sup>    | 0        |
| DWB       | Width reduction parameter                                    | m/V <sup>1/2</sup> | 0        |
| DWG       | Width reduction parameter                                    | m/V                | 0        |
| EASUB     | Electron affinity of substrate                               | V                  | 4.05     |
| EPSRSUB   | Dielectric constant of substrate relative to vacuum          | –                  | 11.7     |
| ETA0      | Subthreshold region DIBL coefficient                         | –                  | 0.08     |
| ETAB      | Subthreshold region DIBL coefficient                         | V <sup>-1</sup>    | -0.07    |
| EU        | Mobility exponent  | –                  | 1.67     |
| FPROUT    | Rout degradation coefficient for pocket devices              | V/m <sup>1/2</sup> | 0        |
| K1        | Bulk effect coefficient 1                                    | V <sup>-1/2</sup>  | 0        |
| K2        | Bulk effect coefficient 2                                    | –                  | 0        |
| K3        | Narrow width effect coefficient                              | –                  | 80       |
| KETA      | Body-bias coefficient of non-uniform depletion width effect. | V <sup>-1</sup>    | -0.047   |
| LAMBDA    | Velocity overshoot parameter                                 | –                  | 0        |
| LC        | back scattering parameter                                    | m                  | 5e-09    |
| LINT      | Length reduction parameter                                   | m                  | 0        |
| LP        | Channel length exponential factor of mobility                | m                  | 1e-08    |
| LPE0      | Equivalent length of pocket region at zero bias              | m                  | 1.74e-07 |

| Parameter | Description  | Units                          | Default   |
|-----------|--|--------------------------------|-----------|
| LPEB      | Equivalent length of pocket region accounting for body bias                  | m                              | 0         |
| MINV      | Fitting parameter for moderate inversion in Vgsteff                          | –                              | 0         |
| NFACTOR   | Subthreshold swing Coefficient   | –                              | 1         |
| NIOSUB    | Intrinsic carrier concentration of substrate at 300.15K                      | cm <sup>-3</sup>               | 1.45e+10  |
| PCLM      | Channel length modulation Coefficient  | –                              | 1.3       |
| PDIBLC1   | Drain-induced barrier lowering coefficient                                   | –                              | 0.39      |
| PDIBLC2   | Drain-induced barrier lowering coefficient                                   | –                              | 0.0086    |
| PDIBLCB   | Body-effect on drain-induced barrier lowering                                | V <sup>-1</sup>                | 0         |
| PDITS     | Coefficient for drain-induced Vth shifts                                     | V <sup>-1</sup>                | 0         |
| PDITSD    | Vds dependence of drain-induced Vth shifts                                   | V <sup>-1</sup>                | 0         |
| PDITSL    | Length dependence of drain-induced Vth shifts                                | m <sup>-1</sup>                | 0         |
| PHIN      | Adjusting parameter for surface potential due to non-uniform vertical doping | V                              | 0         |
| PSCBE1    | Substrate current body-effect coefficient                                    | V/m                            | 4.24e+08  |
| PSCBE2    | Substrate current body-effect coefficient                                    | m/V                            | 1e-05     |
| TBGASUB   | First parameter of band-gap change due to temperature                        | eV/°K                          | 0.000702  |
| TBGBSUB   | Second parameter of band-gap change due to temperature                       | °K                             | 1108      |
| U0        | Low-field mobility at Tnom   | m <sup>2</sup> /(Vs)           | 0.067     |
| UA        | Linear gate dependence of mobility   | m/V                            | 1e-09     |
| UB        | Quadratic gate dependence of mobility  | m <sup>2</sup> /V <sup>2</sup> | 1e-19     |
| UC        | Body-bias dependence of mobility   | V <sup>-1</sup>                | -4.65e-11 |
| UD        | Coulomb scattering factor of mobility  | m <sup>-2</sup>                | 0         |
| UP        | Channel length linear factor of mobility                                     | m <sup>-2</sup>                | 0         |
| VBM       | Maximum body voltage   | V                              | -3        |
| VDDEOT    | Voltage for extraction of equivalent gate oxide thickness                    | V                              | 1.5       |
| VFB       | Flat Band Voltage  | V                              | -1        |
| VOFF      | Threshold voltage offset   | V                              | -0.08     |
| VOFFL     | Length dependence parameter for Vth offset                                   | V                              | 0         |

| Parameter                     | Description   | Units | Default     |
|-------------------------------|---|-------|-------------|
| VSAT                          | Saturation velocity at tnom                           | m/s   | 80000       |
| VTH0                          |   | V     | 0.7         |
| VTL                           | thermal velocity                                      | m/s   | 200000      |
| W0                            | Narrow width effect parameter                         | m     | 2.5e-06     |
| WINT                          | Width reduction parameter                             | m     | 0           |
| XN                            | back scattering parameter                             | -     | 3           |
| <b>Capacitance Parameters</b> |   |       |             |
| ACDE                          | Exponential coefficient for finite charge thickness   | m/V   | 1           |
| CF                            | Fringe capacitance parameter                          | F/m   | 1.07725e-10 |
| CGBO                          | Gate-bulk overlap capacitance per length              | -     | 0           |
| CGDL                          | New C-V model parameter                               | F/m   | 0           |
| CGDO                          | Gate-drain overlap capacitance per width              | F/m   | 1.03594e-09 |
| CGSL                          | New C-V model parameter                               | F/m   | 0           |
| CGSO                          | Gate-source overlap capacitance per width             | F/m   | 1.03594e-09 |
| CKAPPAD                       | D/G overlap C-V parameter                             | V     | 0.6         |
| CKAPPAS                       | S/G overlap C-V parameter                             | V     | 0.6         |
| CLC                           | Vdsat parameter for C-V model                         | m     | 1e-07       |
| CLE                           | Vdsat parameter for C-V model                         | -     | 0.6         |
| DLC                           | Delta L for C-V model                                 | m     | 0           |
| DWC                           | Delta W for C-V model                                 | m     | 0           |
| MINVCV                        | Fitting parameter for moderate inversion in Vgsteffcv | -     | 0           |
| MOIN                          | Coefficient for gate-bias dependent surface potential | -     | 15          |
| NOFF                          | C-V turn-on/off parameter                             | -     | 1           |
| VFBCV                         | Flat Band Voltage parameter for capmod=0 only         | V     | -1          |
| VOFFCV                        | C-V lateral-shift parameter                           | V     | 0           |
| VOFFCVL                       | Length dependence parameter for Vth offset in CV      | -     | 0           |
| XPART                         | Channel charge partitioning                           | F/m   | 0           |
| <b>Control Parameters</b>     |   |       |             |

| Parameter                        | Description   | Units            | Default   |
|----------------------------------|---|------------------|-----------|
| ACNQSMOD                         | AC NQS model selector                                       | –                | 0         |
| BINUNIT                          | Bin unit selector   | –                | 1         |
| CAPMOD                           | Capacitance model selector                                  | –                | 2         |
| CVCHARGEMOD                      | Capacitance charge model selector                           | –                | 0         |
| DIOMOD                           | Diode IV model selector                                     | –                | 1         |
| FNOIMOD                          | Flicker noise model selector                                | –                | 1         |
| GEOMOD                           | Geometry dependent parasitics model selector                | –                | 0         |
| IGBMOD                           | Gate-to-body I <sub>g</sub> model selector                  | –                | 0         |
| IGCMOD                           | Gate-to-channel I <sub>g</sub> model selector               | –                | 0         |
| MOBMOD                           | Mobility model selector                                     | –                | 0         |
| MTRLMOD                          | parameter for nonm-silicon substrate or metal gate selector | –                | 0         |
| PARAMCHK                         | Model parameter checking selector                           | –                | 1         |
| PERMOD                           | Pd and Ps model selector                                    | –                | 1         |
| RBODYMOD                         | Distributed body R model selector                           | –                | 0         |
| RDSMOD                           | Bias-dependent S/D resistance model selector                | –                | 0         |
| RGATEMOD                         | Gate R model selector                                       | –                | 0         |
| TEMPMOD                          | Temperature model selector                                  | –                | 0         |
| TNOIMOD                          | Thermal noise model selector                                | –                | 0         |
| TRNQSMOD                         | Transient NQS model selector                                | –                | 0         |
| VERSION                          | parameter for model version                                 | –                | 4.6.1     |
| <b><i>Flicker Parameters</i></b> |   |                  |           |
| NOIA                             | Flicker Noise parameter a                                   | –                | 6.25e+41  |
| NOIB                             | Flicker Noise parameter b                                   | –                | 3.125e+26 |
| NOIC                             | Flicker Noise parameter c                                   | –                | 8.75e+09  |
| <b><i>Process Parameters</i></b> |   |                  |           |
| DTOX                             | Defined as (toxe - toxp)                                    | m                | 0         |
| EOT                              | Equivalent gate oxide thickness in meters                   | m                | 1.5e-09   |
| EPSROX                           | Dielectric constant of the gate oxide relative to vacuum    | –                | 3.9       |
| GAMMA1                           | V <sub>th</sub> body coefficient                            | V <sup>1/2</sup> | 0         |
| GAMMA2                           | V <sub>th</sub> body coefficient                            | V <sup>1/2</sup> | 0         |

| Parameter                           | Description  | Units                                  | Default  |
|-------------------------------------|--|--|----------|
| NDEP                                | Channel doping concentration at the depletion edge     | cm <sup>-3</sup>                       | 1.7e+17  |
| NGATE                               | Poly-gate doping concentration                         | cm <sup>-3</sup>                       | 0        |
| NSD                                 | S/D doping concentration                               | cm <sup>-3</sup>                       | 1e+20    |
| NSUB                                | Substrate doping concentration                         | cm <sup>-3</sup>                       | 6e+16    |
| RSH                                 | Source-drain sheet resistance                          | ohm/square                             | 0        |
| RSHG                                | Gate sheet resistance                                  | ohm/square                             | 0.1      |
| TOXE                                | Electrical gate oxide thickness in meters              | m                                      | 3e-09    |
| TOXM                                | Gate oxide thickness at which parameters are extracted | m                                      | 3e-09    |
| TOXP                                | Physical gate oxide thickness in meters                | m                                      | 3e-09    |
| VBX                                 | Vth transition body Voltage                            | V                                      | 0        |
| XJ                                  | Junction depth in meters                               | m                                      | 1.5e-07  |
| XT                                  | Doping depth   | m                                      | 1.55e-07 |
| <b><i>Tunnelling Parameters</i></b> |  |  |          |
| AIGBACC                             | Parameter for Igb                                      | (Fs <sup>2</sup> /g) <sup>1/2</sup> /n | 0.0136   |
| AIGBINV                             | Parameter for Igb                                      | (Fs <sup>2</sup> /g) <sup>1/2</sup> /n | 0.0111   |
| AIGC                                | Parameter for Igc                                      | (Fs <sup>2</sup> /g) <sup>1/2</sup> /n | 0.0136   |
| AIGD                                | Parameter for Igd                                      | (Fs <sup>2</sup> /g) <sup>1/2</sup> /n | 0.0136   |
| AIGS                                | Parameter for Igs                                      | (Fs <sup>2</sup> /g) <sup>1/2</sup> /n | 0.0136   |
| BIGBACC                             | Parameter for Igb                                      | (Fs <sup>2</sup> /g) <sup>1/2</sup> /n | 0.000171 |
| BIGBINV                             | Parameter for Igb                                      | (Fs <sup>2</sup> /g) <sup>1/2</sup> /n | 0.000949 |
| BIGC                                | Parameter for Igc                                      | (Fs <sup>2</sup> /g) <sup>1/2</sup> /n | 0.000171 |
| BIGD                                | Parameter for Igd                                      | (Fs <sup>2</sup> /g) <sup>1/2</sup> /n | 0.000171 |
| BIGS                                | Parameter for Igs                                      | (Fs <sup>2</sup> /g) <sup>1/2</sup> /n | 0.000171 |
| CIGBACC                             | Parameter for Igb                                      | V <sup>-1</sup>                        | 0.075    |
| CIGBINV                             | Parameter for Igb                                      | V <sup>-1</sup>                        | 0.006    |
| CIGC                                | Parameter for Igc                                      | V <sup>-1</sup>                        | 0.075    |
| CIGD                                | Parameter for Igd                                      | V <sup>-1</sup>                        | 0.075    |
| CIGS                                | Parameter for Igs                                      | V <sup>-1</sup>                        | 0.075    |
| DLICIGD                             | Delta L for Ig model drain side                        | m                                      | 0        |

| Parameter  | Description                                  | Units                  | Default |
|--|--|------------------------|---------|
| EIGBINV  | Parameter for the Si bandgap for Igbinv      | V                      | 1.1     |
| NIGBACC  | Parameter for Igbacc slope                   | –                      | 1       |
| NIGBINV  | Parameter for Igbinv slope                   | –                      | 3       |
| NIGC   | Parameter for Igc slope                      | –                      | 1       |
| NTOX   | Exponent for Tox ratio                       | –                      | 1       |
| PIGCD  | Parameter for Igc partition                  | –                      | 1       |
| POXEDGE  | Factor for the gate edge Tox                 | –                      | 1       |
| TOXREF   | Target tox value                             | m                      | 3e-09   |
| VFBSDOFF   | S/D flatband voltage offset                  | V                      | 0       |
| <b><i>Asymmetric and Bias-Dependent <math>R_{ds}</math> Parameters</i></b> |  |                        |         |
| PRWB   | Body-effect on parasitic resistance          | $V^{-1}$               | 0       |
| PRWG   | Gate-bias effect on parasitic resistance     | $V^{-1}$               | 1       |
| RDSW   | Source-drain resistance per width            | $\Omega - \mu\text{m}$ | 200     |
| RDSWMIN  | Source-drain resistance per width at high Vg | $\Omega - \mu\text{m}$ | 0       |
| RDW  | Drain resistance per width                   | $\Omega - \mu\text{m}$ | 100     |
| RDWMIN   | Drain resistance per width at high Vg        | $\Omega - \mu\text{m}$ | 0       |
| RSW  | Source resistance per width                  | $\Omega - \mu\text{m}$ | 100     |
| RSWMIN   | Source resistance per width at high Vg       | $\Omega - \mu\text{m}$ | 0       |
| WR   | Width dependence of rds                      | –                      | 1       |
| <b><i>Impact Ionization Current Parameters</i></b>                         |  |                        |         |
| ALPHAO   | substrate current model parameter            | m/V                    | 0       |
| ALPHA1   | substrate current model parameter            | $V^{-1}$               | 0       |
| BETA0  | substrate current model parameter            | $V^{-1}$               | 0       |
| <b><i>Gate-induced Drain Leakage Model Parameters</i></b>                  |  |                        |         |
| AGIDL  | Pre-exponential constant for GIDL            | $\Omega^{-1}$          | 0       |
| AGISL  | Pre-exponential constant for GISL            | $\Omega^{-1}$          | 0       |
| BGIDL  | Exponential constant for GIDL                | V/m                    | 2.3e+09 |
| BGISL  | Exponential constant for GISL                | V/m                    | 2.3e-09 |
| CGIDL  | Parameter for body-bias dependence of GIDL   | $V^3$                  | 0.5     |
| CGISL  | Parameter for body-bias dependence of GISL   | $V^3$                  | 0.5     |
| EGIDL  | Fitting parameter for Bandbending            | V                      | 0.8     |

| Parameter | Description                       | Units | Default |
|-----------|-----------------------------------|-------|---------|
| EGISL     | Fitting parameter for Bandbending | V     | 0.8     |

Table 2.33: BSIM4 Device Model Parameters.

### Model level 18 (VDMOS)

The vertical double-diffused power MOSFET model is based on the uniform charge control model (UCCM) developed at Rensselaer Polytechnic Institute [13]. The VDMOS current-voltage characteristics are described by a single, continuous analytical expression for all regimes of operation. The physics-based model includes effects such as velocity saturation in the channel, drain induced barrier lowering, finite output conductance in saturation, the quasi-saturation effect through a bias dependent drain parasitic resistance, effects of bulk charge, and bias dependent low-field mobility. An important feature of the implementation is the utilization of a single continuous expression for the drain current, which is valid below and above threshold, effectively removing discontinuities and improving convergence properties.

The following tables give parameters for the level 18 MOSFET.

| Parameter | Description  | Units          | Default |
|-----------|--|----------------|---------|
| AD        | Drain diffusion area                                       | m <sup>2</sup> | 0       |
| AS        | Source diffusion area                                      | m <sup>2</sup> | 0       |
| L         | Channel length   | m              | 0.0001  |
| M         | Multiplier for M devices connected in parallel             | –              | 1       |
| NRD       | Multiplier for RSH to yield parasitic resistance of drain  | squares        | 0       |
| NRS       | Multiplier for RSH to yield parasitic resistance of source | squares        | 0       |
| PD        | Drain diffusion perimeter                                  | m              | 0       |
| PS        | Source diffusion perimeter                                 | m              | 0       |
| TEMP      | Device temperature   | °C             | 27      |
| W         | Channel width  | m              | 0.0001  |

Table 2.34: Power MOSFET Device Parameters.



| Parameter | Description  | Units            | Default |
|-----------|--|------------------|---------|
| ALPHA     | Parameter accounting for the threshold dependence on the channel potential | –                | 1.05    |
| CBD       | Zero-bias bulk-drain p-n capacitance                                       | F                | 0       |
| CBS       | Zero-bias bulk-source p-n capacitance                                      | F                | 0       |
| CGBO      | Gate-bulk overlap capacitance/channel length                               | F/m              | 0       |
| CGDO      | Gate-drain overlap capacitance/channel width                               | F/m              | 0       |
| CGSO      | Gate-source overlap capacitance/channel width                              | F/m              | 0       |
| CJ        | Bulk p-n zero-bias bottom capacitance/area                                 | F/m <sup>2</sup> | 0       |
| CJSW      | Bulk p-n zero-bias sidewall capacitance/area                               | F/m <sup>2</sup> | 0       |
| CV        | Charge model storage selector  | –                | 1       |
| CVE       | Meyer-like capacitor model selector  | –                | 1       |
| D1AF      | Drain-source diode flicker noise exponent                                  | –                | 1       |
| D1BV      | Drain-source diode reverse breakdown voltage                               | V                | 1e+99   |
| D1CJO     | Drain-source diode junction capacitance                                    | F                | 0       |
| D1EG      | Drain-source diode activation energy                                       | eV               | 1.11    |
| D1FC      | Drain-source diode forward bias depletion capacitance                      | –                | 0.5     |
| D1IBV     | Drain-source diode current at breakdown voltage                            | A                | 0.001   |
| D1IKF     | Drain-source diode high injection knee current                             | A                | 0       |
| D1IS      | Drain-Source diode saturation current                                      | A                | 1e-14   |
| D1ISR     | Drain-source diode recombination saturation current                        | A                | 0       |
| D1KF      | Drain-source diode flicker noise coefficient                               | –                | 0       |
| D1M       | Drain-source diode grading coefficient                                     | –                | 0.5     |
| D1N       | Drain-source diode emission coefficient                                    | –                | 1       |
| D1NR      | Drain-source diode recombination emission coefficient                      | –                | 2       |
| D1RS      | Drain-source diode ohmic resistance  | Ω                | 0       |
| D1TNOM    | Drain-source diode nominal temperature                                     | °C               | 300.15  |
| D1TT      | Drain-source diode transit time  | s                | 0       |
| D1VJ      | Drain-source diode junction potential                                      | V                | 1       |
| D1XTI     | Drain-source diode sat. current temperature exponent                       | –                | 3       |
| DELTA     | Transition width parameter   | –                | 5       |

| Parameter   | Description   | Units      | Default |
|-------------|---|------------|---------|
| DRIFTPARAMA | Drift region resistance intercept parameter                       | $\Omega$   | 0.08    |
| DRIFTPARAMB | Drift region resistance slope parameter                           | ohm/volt   | 0.013   |
| ETA         | Subthreshold ideality factor                                      | –          | 1.32    |
| FC          | Coefficient for forward-bias depletion capacitance formula        | –          | 0.5     |
| FPE         | Charge partitioning scheme selector                               | –          | 1       |
| GAMMALO     | Body effect constant in front of linear term                      | –          | 0       |
| GAMMASO     | Body effect constant in front of square root term                 | $V^{-1/2}$ | 0.5     |
| IS          | Bulk p-n saturation current                                       | A          | 1e-14   |
| JS          | Bulk p-n saturation current density                               | $A/m^2$    | 0       |
| L0          | Gate length of nominal device                                     | m          | 0.0001  |
| LAMBDA      | Output conductance parameter                                      | $V^{-1}$   | 0.048   |
| LD          | Lateral diffusion length  | m          | 0       |
| LGAMMAL     | Sensitivity of gL on device length                                | –          | 0       |
| LGAMMAS     | Sensitivity of gS on device length                                | $V^{-1/2}$ | 0       |
| M           | Knee shape parameter  | –          | 4       |
| MCV         | Transition width parameter used by the charge partitioning scheme | –          | 10      |
| MJ          | Bulk p-n bottom grading coefficient                               | –          | 0.5     |
| MJSW        | Bulk p-n sidewall grading coefficient                             | –          | 0.5     |
| NSS         | Surface state density   | $cm^{-2}$  | 0       |
| NSUB        | Substrate doping density  | $cm^{-3}$  | 0       |
| PB          | Bulk p-n bottom potential   | V          | 0.8     |
| PHI         | Surface potential   | V          | 0.6     |
| RD          | Drain ohmic resistance  | $\Omega$   | 0       |
| RDSSHUNT    | Drain-source shunt resistance                                     | $\Omega$   | 0       |
| RG          | Gate ohmic resistance   | $\Omega$   | 0       |
| RS          | Source ohmic resistance   | $\Omega$   | 0       |
| RSH         | Drain, source diffusion sheet resistance                          | $\Omega$   | 0       |
| SIGMA0      | DIBL parameter  | –          | 0.048   |

| Parameter | Description   | Units                  | Default |
|-----------|---|------------------------|---------|
| TEMPMODEL | Specification to type of parameter interpolation over temperature (see User Guide section 5.3 | –                      | NONE    |
| THETA     | Mobility degradation parameter  | m/V                    | 0       |
| TNOM      | Nominal device temperature  | °C                     | 27      |
| TOX       | Gate oxide thickness  | m                      | 1e-07   |
| TPG       | Gate material type (-1 = same as substrate, 0 = aluminum, 1 = opposite of substrate           | –                      | 1       |
| U0        | Surface mobility  | 1/(Vcm <sup>2</sup> s) | 280     |
| VFB       | Flat band voltage   | V                      | 1e-12   |
| VMAX      | Maximum drift velocity for carriers   | m/s                    | 40000   |
| VSIGMA    | DIBL parameter  | V                      | 0.2     |
| VSIGMAT   | DIBL parameter  | V                      | 1.7     |
| VTO       | Zero-bias threshold voltage   | V                      | 0       |
| W0        | Gate width of nominal device  | m                      | 0.0001  |
| WGAMMAL   | Sensitivity of gL on device width   | –                      | 0       |
| WGAMMAS   | Sensitivity of gS on device width   | V <sup>-1/2</sup>      | 0       |
| XJ        | Metallurgical junction depth  | m                      | 0       |
| XQC       | Charge partitioning factor  | –                      | 0.6     |

Table 2.35: Power MOSFET Model Parameters.

### Model level 103 (PSP version 103.1)

As of Release 5.2, **Xyce** includes the PSP MOSFET model, version 103.1 [14]. Full documentation for the PSP model is available on its web site, [http://pspmodel.asu.edu/psp\\_documentation.htm](http://pspmodel.asu.edu/psp_documentation.htm). Instance and model parameters for the PSP model are given in tables 2.36 and 2.37.

| Parameter | Description                    | Units | Default |
|-----------|--------------------------------|-------|---------|
| ABDRAIN   | Bottom area of drain junction  | –     | 1e-12   |
| ABSOURCE  | Bottom area of source junction | –     | 1e-12   |
| AD        | Bottom area of drain junction  | –     | 1e-12   |
| AS        | Bottom area of source junction | –     | 1e-12   |

| Parameter | Description   | Units | Default |
|-----------|---|-------|---------|
| DELVTO    | Threshold voltage shift parameter                                       | –     | 0       |
| FACTUO    | Zero-field mobility pre-factor  | –     | 1       |
| JW        | Gate-edge length of source/drain junction                               | –     | 1e-06   |
| L         | Design length   | –     | 1e-05   |
| LGDRAIN   | Gate-edge length of drain junction                                      | –     | 1e-06   |
| LGSOURCE  | Gate-edge length of source junction                                     | –     | 1e-06   |
| LSDRAIN   | STI-edge length of drain junction                                       | –     | 1e-06   |
| LSSOURCE  | STI-edge length of source junction                                      | –     | 1e-06   |
| MULT      | Number of devices in parallel   | –     | 1       |
| NF        | Number of fingers   | –     | 1       |
| NGCON     | Number of gate contacts   | –     | 1       |
| NRD       | Number of squares of drain diffusion                                    | –     | 0       |
| NRS       | Number of squares of source diffusion                                   | –     | 0       |
| PD        | Perimeter of drain junction   | –     | 1e-06   |
| PS        | Perimeter of source junction  | –     | 1e-06   |
| SA        | Distance between OD-edge and poly from one side                         | –     | 0       |
| SB        | Distance between OD-edge and poly from other side                       | –     | 0       |
| SC        | Distance between OD-edge and nearest well edge                          | –     | 0       |
| SCA       | Integral of the first distribution function for scattered well dopants  | –     | 0       |
| SCB       | Integral of the second distribution function for scattered well dopants | –     | 0       |
| SCC       | Integral of the third distribution function for scattered well dopants  | –     | 0       |
| SD        | Distance between neighbouring fingers                                   | –     | 0       |
| W         | Design width  | –     | 1e-05   |
| XGW       | Distance from the gate contact to the channel edge                      | –     | 1e-07   |

Table 2.36: PSP103VA MOSFET Device Instance Parameters.

| Parameter | Description                  | Units | Default |
|-----------|------------------------------|-------|---------|
| A1        | Impact-ionization pre-factor | –     | 1       |

| Parameter | Description   | Units      | Default |
|-----------|---|------------|---------|
| A1L       | Length dependence of A1                                     | –          | 0       |
| A10       | Geometry independent impact-ionization pre-factor           | –          | 1       |
| A1W       | Width dependence of A1                                      | –          | 0       |
| A2        | Impact-ionization exponent at TR                            | V          | 10      |
| A20       | Impact-ionization exponent at TR                            | V          | 10      |
| A3        | Saturation-voltage dependence of impact-ionization          | –          | 1       |
| A3L       | Length dependence of A3                                     | –          | 0       |
| A30       | Geometry independent saturation-voltage dependence of II    | –          | 1       |
| A3W       | Width dependence of A3                                      | –          | 0       |
| A4        | Back-bias dependence of impact-ionization                   | $V^{-1/2}$ | 0       |
| A4L       | Length dependence of A4                                     | –          | 0       |
| A40       | Geometry independent back-bias dependence of II             | $V^{-1/2}$ | 0       |
| A4W       | Width dependence of A4                                      | –          | 0       |
| AGIDL     | GIDL pre-factor   | $A/V^3$    | 0       |
| AGIDLD    | GIDL pre-factor for drain side                              | $A/V^3$    | 0       |
| AGIDLDW   | Width dependence of GIDL pre-factor for drain side          | $A/V^3$    | 0       |
| AGIDLW    | Width dependence of GIDL pre-factor                         | $A/V^3$    | 0       |
| ALP       | CLM pre-factor  | –          | 0.01    |
| ALP1      | CLM enhancement factor above threshold                      | V          | 0       |
| ALP1L1    | Length dependence of CLM enhancement factor above threshold | V          | 0       |
| ALP1L2    | Second order length dependence of ALP1                      | –          | 0       |
| ALP1LEXP  | Exponent for length dependence of ALP1                      | –          | 0.5     |
| ALP1W     | Width dependence of ALP1                                    | –          | 0       |
| ALP2      | CLM enhancement factor below threshold                      | $V^{-1}$   | 0       |
| ALP2L1    | Length dependence of CLM enhancement factor below threshold | $V^{-1}$   | 0       |
| ALP2L2    | Second order length dependence of ALP2                      | –          | 0       |
| ALP2LEXP  | Exponent for length dependence of ALP2                      | –          | 0.5     |
| ALP2W     | Width dependence of ALP2                                    | –          | 0       |

| Parameter | Description  | Units                | Default |
|-----------|--|----------------------|---------|
| ALPL      | Length dependence of ALP   | –                    | 0.0005  |
| ALPLEXP   | Exponent for length dependence of ALP  | –                    | 1       |
| ALPNOI    | Exponent for length offset for flicker noise                                     | –                    | 2       |
| ALPW      | Width dependence of ALP  | –                    | 0       |
| AX        | Linear/saturation transition factor  | –                    | 3       |
| AXL       | Length dependence of AX  | –                    | 0.4     |
| AXO       | Geometry independent linear/saturation transition factor                         | –                    | 18      |
| BETN      | Channel aspect ratio times zero-field mobility                                   | m <sup>2</sup> /(Vs) | 0.07    |
| BETW1     | First higher-order width scaling coefficient of BETN                             | –                    | 0       |
| BETW2     | Second higher-order width scaling coefficient of BETN                            | –                    | 0       |
| BGIDL     | GIDL probability factor at TR  | V                    | 41      |
| BGIDLD    | GIDL probability factor at TR for drain side                                     | V                    | 41      |
| BGIDLDO   | GIDL probability factor at TR for drain side                                     | V                    | 41      |
| BGIDLO    | GIDL probability factor at TR  | V                    | 41      |
| CBBTBOT   | Band-to-band tunneling prefactor of bottom component for source-bulk junction    | –                    | 1e-12   |
| CBBTBOTD  | Band-to-band tunneling prefactor of bottom component for drain-bulk junction     | –                    | 1e-12   |
| CBBTGAT   | Band-to-band tunneling prefactor of gate-edge component for source-bulk junction | –                    | 1e-18   |
| CBBTGATD  | Band-to-band tunneling prefactor of gate-edge component for drain-bulk junction  | –                    | 1e-18   |
| CBBTSTI   | Band-to-band tunneling prefactor of STI-edge component for source-bulk junction  | –                    | 1e-18   |
| CBBTSTID  | Band-to-band tunneling prefactor of STI-edge component for drain-bulk junction   | –                    | 1e-18   |
| CF        | DIBL-parameter   | –                    | 0       |
| CFB       | Back bias dependence of CF   | V <sup>-1</sup>      | 0       |
| CFBO      | Back-bias dependence of CF   | V <sup>-1</sup>      | 0       |
| CFL       | Length dependence of DIBL-parameter  | –                    | 0       |
| CFLEXP    | Exponent for length dependence of CF   | –                    | 2       |
| CFR       | Outer fringe capacitance   | F                    | 0       |

| Parameter | Description  | Units | Default |
|-----------|--|-------|---------|
| CFRD      | Outer fringe capacitance for drain side  | F     | 0       |
| CFRDW     | Outer fringe capacitance for 1 um wide channel for drain side                            | F     | 0       |
| CFRW      | Outer fringe capacitance for 1 um wide channel   | F     | 0       |
| CFW       | Width dependence of CF   | –     | 0       |
| CGBOV     | Oxide capacitance for gate-bulk overlap  | F     | 0       |
| CGBOVL    | Oxide capacitance for gate-bulk overlap for 1 um long channel                            | F     | 0       |
| CGIDL     | Back-bias dependence of GIDL   | –     | 0       |
| CGIDLD    | Back-bias dependence of GIDL for drain side  | –     | 0       |
| CGIDLDO   | Back-bias dependence of GIDL for drain side  | –     | 0       |
| CGIDL0    | Back-bias dependence of GIDL   | –     | 0       |
| CGOV      | Oxide capacitance for gate-drain/source overlap  | F     | 1e-15   |
| CGOVD     | Oxide capacitance for gate-drain overlap   | F     | 1e-15   |
| CHIB      | Tunneling barrier height   | V     | 3.1     |
| CHIB0     | Tunneling barrier height   | V     | 3.1     |
| CJORBOT   | Zero-bias capacitance per unit-of-area of bottom component for source-bulk junction      | –     | 0.001   |
| CJORBOTD  | Zero-bias capacitance per unit-of-area of bottom component for drain-bulk junction       | –     | 0.001   |
| CJORGAT   | Zero-bias capacitance per unit-of-length of gate-edge component for source-bulk junction | –     | 1e-09   |
| CJORGATD  | Zero-bias capacitance per unit-of-length of gate-edge component for drain-bulk junction  | –     | 1e-09   |
| CJORSTI   | Zero-bias capacitance per unit-of-length of STI-edge component for source-bulk junction  | –     | 1e-09   |
| CJORSTID  | Zero-bias capacitance per unit-of-length of STI-edge component for drain-bulk junction   | –     | 1e-09   |
| COX       | Oxide capacitance for intrinsic channel  | F     | 1e-14   |
| CS        | Coulomb scattering parameter at TR   | –     | 0       |
| CSL       | Length dependence of CS  | –     | 0       |
| CSLEXP    | Exponent for length dependence of CS   | –     | 1       |
| CSLW      | Area dependence of CS  | –     | 0       |

| Parameter | Description   | Units | Default |
|-----------|---|-------|---------|
| CS0       | Geometry independent coulomb scattering parameter at TR                           | –     | 0       |
| CSRHBOT   | Shockley-Read-Hall prefactor of bottom component for source-bulk junction         | –     | 100     |
| CSRHBOTD  | Shockley-Read-Hall prefactor of bottom component for drain-bulk junction          | –     | 100     |
| CSRHGAT   | Shockley-Read-Hall prefactor of gate-edge component for source-bulk junction      | –     | 0.0001  |
| CSRHGATD  | Shockley-Read-Hall prefactor of gate-edge component for drain-bulk junction       | –     | 0.0001  |
| CSRHSTI   | Shockley-Read-Hall prefactor of STI-edge component for source-bulk junction       | –     | 0.0001  |
| CSRHSTID  | Shockley-Read-Hall prefactor of STI-edge component for drain-bulk junction        | –     | 0.0001  |
| CSW       | Width dependence of CS  | –     | 0       |
| CT        | Interface states factor   | –     | 0       |
| CTATBOT   | Trap-assisted tunneling prefactor of bottom component for source-bulk junction    | –     | 100     |
| CTATBOTD  | Trap-assisted tunneling prefactor of bottom component for drain-bulk junction     | –     | 100     |
| CTATGAT   | Trap-assisted tunneling prefactor of gate-edge component for source-bulk junction | –     | 0.0001  |
| CTATGATD  | Trap-assisted tunneling prefactor of gate-edge component for drain-bulk junction  | –     | 0.0001  |
| CTATSTI   | Trap-assisted tunneling prefactor of STI-edge component for source-bulk junction  | –     | 0.0001  |
| CTATSTID  | Trap-assisted tunneling prefactor of STI-edge component for drain-bulk junction   | –     | 0.0001  |
| CTL       | Length dependence of interface states factor                                      | –     | 0       |
| CTLEXP    | Exponent for length dependence of interface states factor                         | –     | 1       |
| CTLW      | Area dependence of interface states factor  | –     | 0       |
| CT0       | Geometry-independent interface states factor                                      | –     | 0       |
| CTW       | Width dependence of interface states factor                                       | –     | 0       |



| Parameter   | Description  | Units           | Default |
|-------------|--|-----------------|---------|
| DELVTAC     | Offset parameter for PHIB in separate charge calculation                                   | V               | 0       |
| DELVTACL    | Length dependence of DELVTAC   | V               | 0       |
| DELVTACLEXP | Exponent for length dependence of offset of DELVTAC  | –               | 1       |
| DELVTACLW   | Area dependence of DELVTAC   | V               | 0       |
| DELVTACO    | Geom. independent offset parameter for PHIB in separate charge calculation                 | V               | 0       |
| DELVTACW    | Width dependence of DELVTAC  | V               | 0       |
| DLQ         | Effective channel length reduction for CV  | m               | 0       |
| DLSIL       | Silicide extension over the physical gate length   | m               | 0       |
| DNSUB       | Effective doping bias-dependence parameter   | V <sup>-1</sup> | 0       |
| DNSUBO      | Effective doping bias-dependence parameter   | V <sup>-1</sup> | 0       |
| DPHIB       | Offset parameter for PHIB  | V               | 0       |
| DPHIBL      | Length dependence offset of PHIB   | V               | 0       |
| DPHIBLEXP   | Exponent for length dependence of offset of PHIB   | –               | 1       |
| DPHIBLW     | Area dependence of offset of PHIB  | V               | 0       |
| DPHIBO      | Geometry independent offset of PHIB  | V               | 0       |
| DPHIBW      | Width dependence of offset of PHIB   | V               | 0       |
| DTA         | Temperature offset w.r.t. ambient temperature  | °K              | 0       |
| DVSBNUD     | Vsb-range for NUD-effect   | V               | 1       |
| DVSBNUDO    | Vsb range for NUD-effect   | V               | 1       |
| DWQ         | Effective channel width reduction for CV   | m               | 0       |
| EF          | Flicker noise frequency exponent   | –               | 1       |
| EFO         | Flicker noise frequency exponent   | –               | 1       |
| EPSROX      | Relative permittivity of gate dielectric   | –               | 3.9     |
| EPSROX0     | Relative permittivity of gate dielectric   | –               | 3.9     |
| FACNEFFAC   | Pre-factor for effective substrate doping in separate charge calculation                   | –               | 1       |
| FACNEFFACL  | Length dependence of FACNEFFAC   | –               | 0       |
| FACNEFFACLW | Area dependence of FACNEFFAC   | –               | 0       |
| FACNEFFACO  | Geom. independent pre-factor for effective substrate doping in separate charge calculation | –               | 1       |

| Parameter  | Description   | Units | Default |
|------------|---|-------|---------|
| FACNEFFACW | Width dependence of FACNEFFAC   | –     | 0       |
| FBOTRBOT   | Normalization field at the reference temperature for band-to-band tunneling of bottom component for source-bulk junction    | –     | 1e+09   |
| FBOTRBOTD  | Normalization field at the reference temperature for band-to-band tunneling of bottom component for drain-bulk junction     | –     | 1e+09   |
| FBOTRGAT   | Normalization field at the reference temperature for band-to-band tunneling of gate-edge component for source-bulk junction | –     | 1e+09   |
| FBOTRGATD  | Normalization field at the reference temperature for band-to-band tunneling of gate-edge component for drain-bulk junction  | –     | 1e+09   |
| FBOTRSTI   | Normalization field at the reference temperature for band-to-band tunneling of STI-edge component for source-bulk junction  | –     | 1e+09   |
| FBOTRSTID  | Normalization field at the reference temperature for band-to-band tunneling of STI-edge component for drain-bulk junction   | –     | 1e+09   |
| FBET1      | Relative mobility decrease due to first lateral profile   | –     | 0       |
| FBET1W     | Width dependence of relative mobility decrease due to first lateral profile   | –     | 0       |
| FBET2      | Relative mobility decrease due to second lateral profile  | –     | 0       |
| FETA       | Effective field parameter   | –     | 1       |
| FETAO      | Effective field parameter   | –     | 1       |
| FJUNQ      | Fraction below which source-bulk junction capacitance components are considered negligible                                  | –     | 0.03    |
| FJUNQD     | Fraction below which drain-bulk junction capacitance components are considered negligible                                   | –     | 0.03    |
| FNT        | Thermal noise coefficient   | –     | 1       |
| FNT0       | Thermal noise coefficient   | –     | 1       |
| FOL1       | First length dependence coefficient for short channel body effect   | –     | 0       |
| FOL2       | Second length dependence coefficient for short channel body effect  | –     | 0       |

| Parameter   | Description   | Units | Default |
|-------------|---|-------|---------|
| GC2         | Gate current slope factor   | –     | 0.375   |
| GC20        | Gate current slope factor   | –     | 0.375   |
| GC3         | Gate current curvature factor   | –     | 0.063   |
| GC30        | Gate current curvature factor   | –     | 0.063   |
| GC0         | Gate tunneling energy adjustment  | –     | 0       |
| GC00        | Gate tunneling energy adjustment  | –     | 0       |
| GFACNUD     | Bodyfactor change due to NUD-effect   | –     | 1       |
| GFACNUDL    | Length dependence of GFACNUD  | –     | 0       |
| GFACNUDLEXP | Exponent for length dependence of GFACNUD   | –     | 1       |
| GFACNUDLW   | Area dependence of GFACNUD  | –     | 0       |
| GFACNUDO    | Geom. independent bodyfactor change due to NUD-effect   | –     | 1       |
| GFACNUDW    | Width dependence of GFACNUD   | –     | 0       |
| IDSATRBOT   | Saturation current density at the reference temperature of bottom component for source-bulk junction    | –     | 1e-12   |
| IDSATRBOTD  | Saturation current density at the reference temperature of bottom component for drain-bulk junction     | –     | 1e-12   |
| IDSATRGAT   | Saturation current density at the reference temperature of gate-edge component for source-bulk junction | –     | 1e-18   |
| IDSATRGATD  | Saturation current density at the reference temperature of gate-edge component for drain-bulk junction  | –     | 1e-18   |
| IDSATRSTI   | Saturation current density at the reference temperature of STI-edge component for source-bulk junction  | –     | 1e-18   |
| IDSATRSTID  | Saturation current density at the reference temperature of STI-edge component for drain-bulk junction   | –     | 1e-18   |
| IGINV       | Gate channel current pre-factor   | A     | 0       |
| IGINVLW     | Gate channel current pre-factor for 1 um**2 channel area  | A     | 0       |
| IGOV        | Gate overlap current pre-factor   | A     | 0       |
| IGOVD       | Gate overlap current pre-factor for drain side  | A     | 0       |
| IGOVDW      | Gate overlap current pre-factor for 1 um wide channel for drain side                                    | A     | 0       |
| IGOVW       | Gate overlap current pre-factor for 1 um wide channel   | A     | 0       |

| Parameter | Description   | Units | Default |
|-----------|---|-------|---------|
| IMAX      | Maximum current up to which forward current behaves exponentially                   | –     | 1000    |
| KUO       | Mobility degradation/enhancement coefficient  | m     | 0       |
| KUOWEL    | Length dependent mobility degradation factor  | –     | 0       |
| KUOWELW   | Area dependent mobility degradation factor  | –     | 0       |
| KUOWEO    | Geometrical independent mobility degradation factor                                 | –     | 0       |
| KUOWEW    | Width dependent mobility degradation factor   | –     | 0       |
| KVSAT     | Saturation velocity degradation/enhancement coefficient                             | m     | 0       |
| KVTHO     | Threshold shift parameter   | Vm    | 0       |
| KVTHOWEL  | Length dependent threshold shift parameter  | –     | 0       |
| KVTHOWELW | Area dependent threshold shift parameter  | –     | 0       |
| KVTHOWEO  | Geometrical independent threshold shift parameter                                   | –     | 0       |
| KVTHOWEW  | Width dependent threshold shift parameter   | –     | 0       |
| LAP       | Effective channel length reduction per side   | m     | 0       |
| LEVEL     | Model level   | –     | 103     |
| LINTNOI   | Length offset for flicker noise   | m     | 0       |
| LKUO      | Length dependence of KUO  | –     | 0       |
| LKVTHO    | Length dependence of KVTHO  | –     | 0       |
| LLODKUO   | Length parameter for UO stress effect   | –     | 0       |
| LLODVTH   | Length parameter for VTH-stress effect  | –     | 0       |
| LMAX      | Dummy parameter to label binning set  | m     | 1       |
| LMIN      | Dummy parameter to label binning set  | m     | 0       |
| LODETA0   | eta0 shift modification factor for stress effect                                    | –     | 1       |
| LOV       | Overlap length for gate/drain and gate/source overlap capacitance                   | m     | 0       |
| LOVD      | Overlap length for gate/drain overlap capacitance                                   | m     | 0       |
| LP1       | Mobility-related characteristic length of first lateral profile                     | m     | 1e-08   |
| LP1W      | Width dependence of mobility-related characteristic length of first lateral profile | –     | 0       |
| LP2       | Mobility-related characteristic length of second lateral profile                    | m     | 1e-08   |

| Parameter   | Description   | Units    | Default |
|-------------|---|----------|---------|
| LPCK        | Char. length of lateral doping profile  | m        | 1e-08   |
| LPCKW       | Width dependence of char. length of lateral doping profile  | –        | 0       |
| LVARL       | Length dependence of LVAR   | –        | 0       |
| LVARO       | Geom. independent difference between actual and programmed gate length  | m        | 0       |
| LVARW       | Width dependence of LVAR  | –        | 0       |
| MEFFTATBOT  | Effective mass (in units of $m_0$ ) for trap-assisted tunneling of bottom component for source-bulk junction    | –        | 0.25    |
| MEFFTATBOTD | Effective mass (in units of $m_0$ ) for trap-assisted tunneling of bottom component for drain-bulk junction     | –        | 0.25    |
| MEFFTATGAT  | Effective mass (in units of $m_0$ ) for trap-assisted tunneling of gate-edge component for source-bulk junction | –        | 0.25    |
| MEFFTATGATD | Effective mass (in units of $m_0$ ) for trap-assisted tunneling of gate-edge component for drain-bulk junction  | –        | 0.25    |
| MEFFTATSTI  | Effective mass (in units of $m_0$ ) for trap-assisted tunneling of STI-edge component for source-bulk junction  | –        | 0.25    |
| MEFFTATSTID | Effective mass (in units of $m_0$ ) for trap-assisted tunneling of STI-edge component for drain-bulk junction   | –        | 0.25    |
| MUE         | Mobility reduction coefficient at TR  | m/V      | 0.5     |
| MUEO        | Geometry independent mobility reduction coefficient at TR   | m/V      | 0.5     |
| MUEW        | Width dependence of mobility reduction coefficient at TR  | –        | 0       |
| NEFF        | Effective substrate doping  | $m^{-3}$ | 5e+23   |
| NFA         | First coefficient of flicker noise  | –        | 8e+22   |
| NFALW       | First coefficient of flicker noise for 1 $\mu m^2$ channel area   | –        | 8e+22   |
| NFB         | Second coefficient of flicker noise   | –        | 3e+07   |
| NFBLW       | Second coefficient of flicker noise for 1 $\mu m^2$ channel area  | –        | 3e+07   |
| NFC         | Third coefficient of flicker noise  | $V^{-1}$ | 0       |
| NFCLW       | Third coefficient of flicker noise for 1 $\mu m^2$ channel area   | $V^{-1}$ | 0       |
| NOV         | Effective doping of overlap region  | $m^{-3}$ | 5e+25   |
| NOVD        | Effective doping of overlap region for drain side   | $m^{-3}$ | 5e+25   |

| Parameter | Description  | Units    | Default |
|-----------|--|----------|---------|
| NOVDO     | Effective doping of overlap region for drain side                                | $m^{-3}$ | 5e+25   |
| NOVO      | Effective doping of overlap region   | $m^{-3}$ | 5e+25   |
| NP        | Gate poly-silicon doping   | $m^{-3}$ | 1e+26   |
| NPCK      | Pocket doping level  | $m^{-3}$ | 1e+24   |
| NPCKW     | Width dependence of pocket doping NPCK due to segregation                        | –        | 0       |
| NPL       | Length dependence of gate poly-silicon doping                                    | –        | 0       |
| NPO       | Geometry-independent gate poly-silicon doping                                    | $m^{-3}$ | 1e+26   |
| NSLP      | Effective doping bias-dependence parameter                                       | V        | 0.05    |
| NSLPO     | Effective doping bias-dependence parameter                                       | V        | 0.05    |
| NSUBO     | Geometry independent substrate doping  | $m^{-3}$ | 3e+23   |
| NSUBW     | Width dependence of background doping NSUBO due to segregation                   | –        | 0       |
| PBOT      | Grading coefficient of bottom component for source-bulk junction                 | –        | 0.5     |
| PBOTD     | Grading coefficient of bottom component for drain-bulk junction                  | –        | 0.5     |
| PBRBOT    | Breakdown onset tuning parameter of bottom component for source-bulk junction    | –        | 4       |
| PBRBOTD   | Breakdown onset tuning parameter of bottom component for drain-bulk junction     | –        | 4       |
| PBRGAT    | Breakdown onset tuning parameter of gate-edge component for source-bulk junction | –        | 4       |
| PBRGATD   | Breakdown onset tuning parameter of gate-edge component for drain-bulk junction  | –        | 4       |
| PBRSTI    | Breakdown onset tuning parameter of STI-edge component for source-bulk junction  | –        | 4       |
| PBRSTID   | Breakdown onset tuning parameter of STI-edge component for drain-bulk junction   | –        | 4       |
| PGAT      | Grading coefficient of gate-edge component for source-bulk junction              | –        | 0.5     |
| PGATD     | Grading coefficient of gate-edge component for drain-bulk junction               | –        | 0.5     |

| Parameter | Description  | Units            | Default |
|-----------|--|------------------|---------|
| PHIGBOT   | Zero-temperature bandgap voltage of bottom component for source-bulk junction    | –                | 1.16    |
| PHIGBOTD  | Zero-temperature bandgap voltage of bottom component for drain-bulk junction     | –                | 1.16    |
| PHIGGAT   | Zero-temperature bandgap voltage of gate-edge component for source-bulk junction | –                | 1.16    |
| PHIGGATD  | Zero-temperature bandgap voltage of gate-edge component for drain-bulk junction  | –                | 1.16    |
| PHIGSTI   | Zero-temperature bandgap voltage of STI-edge component for source-bulk junction  | –                | 1.16    |
| PHIGSTID  | Zero-temperature bandgap voltage of STI-edge component for drain-bulk junction   | –                | 1.16    |
| PKUO      | Cross-term dependence of KUO   | –                | 0       |
| PKVTHO    | Cross-term dependence of KVTTHO  | –                | 0       |
| PLA1      | Coefficient for the length dependence of A1                                      | –                | 0       |
| PLA3      | Coefficient for the length dependence of A3                                      | –                | 0       |
| PLA4      | Coefficient for the length dependence of A4                                      | –                | 0       |
| PLAGIDL   | Coefficient for the length dependence of AGIDL                                   | A/V <sup>3</sup> | 0       |
| PLAGIDLD  | Coefficient for the length dependence of AGIDL for drain side                    | A/V <sup>3</sup> | 0       |
| PLALP     | Coefficient for the length dependence of ALP                                     | –                | 0       |
| PLALP1    | Coefficient for the length dependence of ALP1                                    | V                | 0       |
| PLALP2    | Coefficient for the length dependence of ALP2                                    | –                | 0       |
| PLAX      | Coefficient for the length dependence of AX                                      | –                | 0       |
| PLBETN    | Coefficient for the length dependence of BETN                                    | –                | 0       |
| PLCF      | Coefficient for the length dependence of CF                                      | –                | 0       |
| PLCFR     | Coefficient for the length dependence of CFR                                     | F                | 0       |
| PLCFRD    | Coefficient for the length dependence of CFR for drain side                      | F                | 0       |
| PLCGBOV   | Coefficient for the length dependence of CGBOV                                   | F                | 0       |
| PLCGOV    | Coefficient for the length dependence of CGOV                                    | F                | 0       |
| PLCGOVD   | Coefficient for the length dependence of CGOV for drain side                     | F                | 0       |

| Parameter   | Description  | Units           | Default |
|-------------|--|-----------------|---------|
| PLCOX       | Coefficient for the length dependence of COX                 | F               | 0       |
| PLCS        | Coefficient for the length dependence of CS                  | –               | 0       |
| PLCT        | Coefficient for the length dependence of CT                  | –               | 0       |
| PLDELVTAC   | Coefficient for the length dependence of DELVTAC             | V               | 0       |
| PLDPHIB     | Coefficient for the length dependence of DPHIB               | V               | 0       |
| PLFACNEFFAC | Coefficient for the length dependence of FACNEFFAC           | –               | 0       |
| PLGFACNUD   | Coefficient for the length dependence of GFACNUD             | –               | 0       |
| PLIGINV     | Coefficient for the length dependence of IGINV               | A               | 0       |
| PLIGOV      | Coefficient for the length dependence of IGOV                | A               | 0       |
| PLIGOVD     | Coefficient for the length dependence of IGOV for drain side | A               | 0       |
| PLKUOWE     | Coefficient for the length dependence part of KUOWE          | –               | 0       |
| PLKVTHOWE   | Coefficient for the length dependence part of KVTHOWE        | –               | 0       |
| PLMUE       | Coefficient for the length dependence of MUE                 | –               | 0       |
| PLNEFF      | Coefficient for the length dependence of NEFF                | m <sup>-3</sup> | 0       |
| PLNFA       | Coefficient for the length dependence of NFA                 | –               | 0       |
| PLNFB       | Coefficient for the length dependence of NFB                 | –               | 0       |
| PLNFC       | Coefficient for the length dependence of NFC                 | –               | 0       |
| PLNOV       | Coefficient for the length dependence of NOV                 | m <sup>-3</sup> | 0       |
| PLNOVD      | Coefficient for the length dependence of NOV for drain side  | m <sup>-3</sup> | 0       |
| PLNP        | Coefficient for the length dependence of NP                  | m <sup>-3</sup> | 0       |
| PLRS        | Coefficient for the length dependence of RS                  | –               | 0       |
| PLSTBET     | Coefficient for the length dependence of STBET               | –               | 0       |
| PLSTTHESAT  | Coefficient for the length dependence of STTHESAT            | –               | 0       |
| PLSTVFB     | Coefficient for the length dependence of STVFB               | V/K             | 0       |
| PLTHESAT    | Coefficient for the length dependence of THESAT              | –               | 0       |
| PLTHESATB   | Coefficient for the length dependence of THESATB             | –               | 0       |
| PLTHESATG   | Coefficient for the length dependence of THESATG             | –               | 0       |
| PLVFB       | Coefficient for the length dependence of VFB                 | V               | 0       |
| PLWA1       | Coefficient for the length times width dependence of A1      | –               | 0       |



| Parameter  | Description   | Units            | Default |
|------------|---|------------------|---------|
| PLWA3      | Coefficient for the length times width dependence of A3                   | –                | 0       |
| PLWA4      | Coefficient for the length times width dependence of A4                   | –                | 0       |
| PLWAGIDL   | Coefficient for the length times width dependence of AGIDL                | A/V <sup>3</sup> | 0       |
| PLWAGIDLD  | Coefficient for the length times width dependence of AGIDL for drain side | A/V <sup>3</sup> | 0       |
| PLWALP     | Coefficient for the length times width dependence of ALP                  | –                | 0       |
| PLWALP1    | Coefficient for the length times width dependence of ALP1                 | V                | 0       |
| PLWALP2    | Coefficient for the length times width dependence of ALP2                 | –                | 0       |
| PLWAX      | Coefficient for the length times width dependence of AX                   | –                | 0       |
| PLWBETN    | Coefficient for the length times width dependence of BETN                 | –                | 0       |
| PLWCF      | Coefficient for the length times width dependence of CF                   | –                | 0       |
| PLWCFR     | Coefficient for the length times width dependence of CFR                  | F                | 0       |
| PLWCFRD    | Coefficient for the length times width dependence of CFR for drain side   | F                | 0       |
| PLWCGBOV   | Coefficient for the length times width dependence of CGBOV                | F                | 0       |
| PLWCGOV    | Coefficient for the length times width dependence of CGOV                 | F                | 0       |
| PLWCGOVD   | Coefficient for the length times width dependence of CGOV for drain side  | F                | 0       |
| PLWCOX     | Coefficient for the length times width dependence of COX                  | F                | 0       |
| PLWCS      | Coefficient for the length times width dependence of CS                   | –                | 0       |
| PLWCT      | Coefficient for the length times width dependence of CT                   | –                | 0       |
| PLWDELVTAC | Coefficient for the length times width dependence of DELVTAC              | V                | 0       |
| PLWDPHIB   | Coefficient for the length times width dependence of DPHIB                | V                | 0       |

| Parameter    | Description  | Units           | Default |
|--------------|--|-----------------|---------|
| PLWFACNEFFAC | Coefficient for the length times width dependence of FACNEFFAC           | –               | 0       |
| PLWGFACNUD   | Coefficient for the length times width dependence of GFACNUD             | –               | 0       |
| PLWIGINV     | Coefficient for the length times width dependence of IGINV               | A               | 0       |
| PLWIGOV      | Coefficient for the length times width dependence of IGOV                | A               | 0       |
| PLWIGOVD     | Coefficient for the length times width dependence of IGOV for drain side | A               | 0       |
| PLWKUOWE     | Coefficient for the length times width dependence part of KUOWE          | –               | 0       |
| PLWKVTHOWE   | Coefficient for the length times width dependence part of KVTHOWE        | –               | 0       |
| PLWMUE       | Coefficient for the length times width dependence of MUE                 | –               | 0       |
| PLWNEFF      | Coefficient for the length times width dependence of NEFF                | m <sup>-3</sup> | 0       |
| PLWNFA       | Coefficient for the length times width dependence of NFA                 | –               | 0       |
| PLWNFB       | Coefficient for the length times width dependence of NFB                 | –               | 0       |
| PLWNFC       | Coefficient for the length times width dependence of NFC                 | –               | 0       |
| PLWNOV       | Coefficient for the length times width dependence of NOV                 | m <sup>-3</sup> | 0       |
| PLWNOVD      | Coefficient for the length times width dependence of NOV for drain side  | m <sup>-3</sup> | 0       |
| PLWNP        | Coefficient for the length times width dependence of NP                  | m <sup>-3</sup> | 0       |
| PLWRS        | Coefficient for the length times width dependence of RS                  | –               | 0       |
| PLWSTBET     | Coefficient for the length times width dependence of STBET               | –               | 0       |
| PLWSTTHESAT  | Coefficient for the length times width dependence of STTHESAT            | –               | 0       |

| Parameter  | Description   | Units            | Default |
|------------|---|------------------|---------|
| PLWSTVFB   | Coefficient for the length times width dependence of STVFB            | V/K              | 0       |
| PLWTHESAT  | Coefficient for the length times width dependence of THESAT           | –                | 0       |
| PLWTHESATB | Coefficient for the length times width dependence of THESATB          | –                | 0       |
| PLWTHESATG | Coefficient for the length times width dependence of THESATG          | –                | 0       |
| PLWVFB     | Coefficient for the length times width dependence of VFB              | V                | 0       |
| PLWXCOR    | Coefficient for the length times width dependence of XCOR             | –                | 0       |
| PLXCOR     | Coefficient for the length dependence of XCOR                         | –                | 0       |
| POA1       | Coefficient for the geometry independent part of A1                   | –                | 1       |
| POA2       | Coefficient for the geometry independent part of A2                   | V                | 10      |
| POA3       | Coefficient for the geometry independent part of A3                   | –                | 1       |
| POA4       | Coefficient for the geometry independent part of A4                   | –                | 0       |
| POAGIDL    | Coefficient for the geometry independent part of AGIDL                | A/V <sup>3</sup> | 0       |
| POAGIDLD   | Coefficient for the geometry independent part of AGIDL for drain side | A/V <sup>3</sup> | 0       |
| POALP      | Coefficient for the geometry independent part of ALP                  | –                | 0.01    |
| POALP1     | Coefficient for the geometry independent part of ALP1                 | V                | 0       |
| POALP2     | Coefficient for the geometry independent part of ALP2                 | –                | 0       |
| POAX       | Coefficient for the geometry independent part of AX                   | –                | 3       |
| POBETN     | Coefficient for the geometry independent part of BETN                 | –                | 0.07    |
| POBGIDL    | Coefficient for the geometry independent part of BGIDL                | V                | 41      |
| POBGIDLD   | Coefficient for the geometry independent part of BGIDL for drain side | V                | 41      |
| POCF       | Coefficient for the geometry independent part of CF                   | –                | 0       |
| POCFB      | Coefficient for the geometry independent part of CFB                  | –                | 0       |
| POCFR      | Coefficient for the geometry independent part of CFR                  | F                | 0       |
| POCFRD     | Coefficient for the geometry independent part of CFR for drain side   | F                | 0       |

| Parameter   | Description   | Units | Default |
|-------------|---|-------|---------|
| POCGBOV     | Coefficient for the geometry independent part of CGBOV                | F     | 0       |
| POCGIDL     | Coefficient for the geometry independent part of CGIDL                | –     | 0       |
| POCGIDLD    | Coefficient for the geometry independent part of CGIDL for drain side | –     | 0       |
| POCGOV      | Coefficient for the geometry independent part of CGOV                 | F     | 1e-15   |
| POCGOVD     | Coefficient for the geometry independent part of CGOV for drain side  | F     | 1e-15   |
| POCHIB      | Coefficient for the geometry independent part of CHIB                 | V     | 3.1     |
| POCOX       | Coefficient for the geometry independent part of COX                  | F     | 1e-14   |
| POCS        | Coefficient for the geometry independent part of CS                   | –     | 0       |
| POCT        | Coefficient for the geometry independent part of CT                   | –     | 0       |
| PODELVTAC   | Coefficient for the geometry independent part of DELVTAC              | V     | 0       |
| PODNSUB     | Coefficient for the geometry independent part of DNSUB                | –     | 0       |
| PODPHIB     | Coefficient for the geometry independent part of DPHIB                | V     | 0       |
| PODVSENUD   | Coefficient for the geometry independent part of DVSENUD              | V     | 1       |
| POEF        | Coefficient for the flicker noise frequency exponent                  | –     | 1       |
| POEPSROX    | Coefficient for the geometry independent part of EPSOX                | –     | 3.9     |
| POFACNEFFAC | Coefficient for the geometry independent part of FACNEFFAC            | –     | 1       |
| POFETA      | Coefficient for the geometry independent part of FETA                 | –     | 1       |
| POFNT       | Coefficient for the geometry independent part of FNT                  | –     | 1       |
| POGC2       | Coefficient for the geometry independent part of GC2                  | –     | 0.375   |
| POGC3       | Coefficient for the geometry independent part of GC3                  | –     | 0.063   |
| POGCO       | Coefficient for the geometry independent part of GCO                  | –     | 0       |
| POGFACNUD   | Coefficient for the geometry independent part of GFACNUD              | –     | 1       |
| POIGINV     | Coefficient for the geometry independent part of IGINV                | A     | 0       |
| POIGOV      | Coefficient for the geometry independent part of IGOV                 | A     | 0       |
| POIGOVD     | Coefficient for the geometry independent part of IGOV for drain side  | A     | 0       |

| Parameter  | Description   | Units           | Default |
|------------|---|-----------------|---------|
| POKUOWE    | Coefficient for the geometry independent part of KUOWE                  | –               | 0       |
| POKVTHOWE  | Coefficient for the geometry independent part of KVTHOWE                | –               | 0       |
| POMUE      | Coefficient for the geometry independent part of MUE                    | –               | 0.5     |
| PONEFF     | Coefficient for the geometry independent part of NEFF                   | m <sup>-3</sup> | 5e+23   |
| PONFA      | Coefficient for the geometry independent part of NFA                    | –               | 8e+22   |
| PONFB      | Coefficient for the geometry independent part of NFB                    | –               | 3e+07   |
| PONFC      | Coefficient for the geometry independent part of NFC                    | –               | 0       |
| PONOV      | Coefficient for the geometry independent part of NOV                    | m <sup>-3</sup> | 5e+25   |
| PONOVD     | Coefficient for the geometry independent part of NOV for drain side     | m <sup>-3</sup> | 5e+25   |
| PONP       | Coefficient for the geometry independent part of NP                     | m <sup>-3</sup> | 1e+26   |
| PONSLP     | Coefficient for the geometry independent part of NSLP                   | V               | 0.05    |
| PORS       | Coefficient for the geometry independent part of RS                     | –               | 30      |
| PORSB      | Coefficient for the geometry independent part of RSB                    | –               | 0       |
| PORSG      | Coefficient for the geometry independent part of RSG                    | –               | 0       |
| POSTA2     | Coefficient for the geometry independent part of STA2                   | V               | 0       |
| POSTBET    | Coefficient for the geometry independent part of STBET                  | –               | 1       |
| POSTBGIDL  | Coefficient for the geometry independent part of STBGIDL                | V/K             | 0       |
| POSTBGIDLD | Coefficient for the geometry independent part of STBGIDL for drain side | V/K             | 0       |
| POSTCS     | Coefficient for the geometry independent part of STCS                   | –               | 0       |
| POSTIG     | Coefficient for the geometry independent part of STIG                   | –               | 2       |
| POSTMUE    | Coefficient for the geometry independent part of STMUE                  | –               | 0       |
| POSTRS     | Coefficient for the geometry independent part of STRS                   | –               | 1       |
| POSTTHEMU  | Coefficient for the geometry independent part of STTHEMU                | –               | 1.5     |
| POSTTHESAT | Coefficient for the geometry independent part of STTHESAT               | –               | 1       |
| POSTVFB    | Coefficient for the geometry independent part of STVFB                  | V/K             | 0.0005  |

| Parameter | Description   | Units   | Default |
|-----------|---|---------|---------|
| POSTXCOR  | Coefficient for the geometry independent part of STXCOR               | –       | 0       |
| POTHEMU   | Coefficient for the geometry independent part of THEMU                | –       | 1.5     |
| POTHEMAT  | Coefficient for the geometry independent part of THEMAT               | –       | 1       |
| POTHEMATB | Coefficient for the geometry independent part of THEMATB              | –       | 0       |
| POTHEMATG | Coefficient for the geometry independent part of THEMATG              | –       | 0       |
| POTOX     | Coefficient for the geometry independent part of TOX                  | m       | 2e-09   |
| POTOXOV   | Coefficient for the geometry independent part of TOXOV                | m       | 2e-09   |
| POTOXOVD  | Coefficient for the geometry independent part of TOXOV for drain side | m       | 2e-09   |
| POVFB     | Coefficient for the geometry independent part of VFB                  | V       | -1      |
| POVNSUB   | Coefficient for the geometry independent part of VNSUB                | V       | 0       |
| POVP      | Coefficient for the geometry independent part of VP                   | V       | 0.05    |
| POVSBNUD  | Coefficient for the geometry independent part of VSBNUD               | V       | 0       |
| POXCOR    | Coefficient for the geometry independent part of XCOR                 | –       | 0       |
| PSTI      | Grading coefficient of STI-edge component for source-bulk junction    | –       | 0.5     |
| PSTID     | Grading coefficient of STI-edge component for drain-bulk junction     | –       | 0.5     |
| PWA1      | Coefficient for the width dependence of A1                            | –       | 0       |
| PWA3      | Coefficient for the width dependence of A3                            | –       | 0       |
| PWA4      | Coefficient for the width dependence of A4                            | –       | 0       |
| PWAGIDL   | Coefficient for the width dependence of AGIDL                         | $A/V^3$ | 0       |
| PWAGIDLD  | Coefficient for the width dependence of AGIDL for drain side          | $A/V^3$ | 0       |
| PWALP     | Coefficient for the width dependence of ALP                           | –       | 0       |
| PWALP1    | Coefficient for the width dependence of ALP1                          | V       | 0       |
| PWALP2    | Coefficient for the width dependence of ALP2                          | –       | 0       |
| PWAX      | Coefficient for the width dependence of AX                            | –       | 0       |

| Parameter   | Description   | Units    | Default |
|-------------|---|----------|---------|
| PWBETN      | Coefficient for the width dependence of BETN                | –        | 0       |
| PWCF        | Coefficient for the width dependence of CF                  | –        | 0       |
| PWCFR       | Coefficient for the width dependence of CFR                 | F        | 0       |
| PWCFRD      | Coefficient for the width dependence of CFR for drain side  | F        | 0       |
| PWCGBOV     | Coefficient for the width dependence of CGBOV               | F        | 0       |
| PWCGOV      | Coefficient for the width dependence of CGOV                | F        | 0       |
| PWCGOVD     | Coefficient for the width dependence of CGOV for drain side | F        | 0       |
| PWCOX       | Coefficient for the width dependence of COX                 | F        | 0       |
| PWCS        | Coefficient for the width dependence of CS                  | –        | 0       |
| PWCT        | Coefficient for the width dependence of CT                  | –        | 0       |
| PWDELVTAC   | Coefficient for the width dependence of DELVTAC             | V        | 0       |
| PWDPHIB     | Coefficient for the width dependence of DPHIB               | V        | 0       |
| PWFACNEFFAC | Coefficient for the width dependence of FACNEFFAC           | –        | 0       |
| PWGFACTUD   | Coefficient for the width dependence of GFACNUD             | –        | 0       |
| PWIGINV     | Coefficient for the width dependence of IGINV               | A        | 0       |
| PWIGOV      | Coefficient for the width dependence of IGOV                | A        | 0       |
| PWIGOVD     | Coefficient for the width dependence of IGOV for drain side | A        | 0       |
| PWKUOWE     | Coefficient for the width dependence part of KUOWE          | –        | 0       |
| PWKVTHOWE   | Coefficient for the width dependence part of KVTHOWE        | –        | 0       |
| PWMUE       | Coefficient for the width dependence of MUE                 | –        | 0       |
| PWNEFF      | Coefficient for the width dependence of NEFF                | $m^{-3}$ | 0       |
| PWNFA       | Coefficient for the width dependence of NFA                 | –        | 0       |
| PWNFB       | Coefficient for the width dependence of NFB                 | –        | 0       |
| PWNFC       | Coefficient for the width dependence of NFC                 | –        | 0       |
| PWNOV       | Coefficient for the width dependence of NOV                 | $m^{-3}$ | 0       |
| PWNOVD      | Coefficient for the width dependence of NOV for drain side  | $m^{-3}$ | 0       |
| PWNP        | Coefficient for the width dependence of NP                  | $m^{-3}$ | 0       |

| Parameter  | Description  | Units          | Default |
|------------|--|----------------|---------|
| PWRS       | Coefficient for the width dependence of RS         | –              | 0       |
| PWSTBET    | Coefficient for the width dependence of STBET      | –              | 0       |
| PWSTTHESAT | Coefficient for the width dependence of STTHESAT   | –              | 0       |
| PWSTVFB    | Coefficient for the width dependence of STVFB      | V/K            | 0       |
| PWTHESAT   | Coefficient for the width dependence of THESAT     | –              | 0       |
| PWTHESATB  | Coefficient for the width dependence of THESATB    | –              | 0       |
| PWTHESATG  | Coefficient for the width dependence of THESATG    | –              | 0       |
| PWVFB      | Coefficient for the width dependence of VFB        | V              | 0       |
| PWXCOR     | Coefficient for the width dependence of XCOR       | –              | 0       |
| QMC        | Quantum-mechanical correction factor               | –              | 1       |
| RBULK      | Bulk resistance between node BP and BI             | $\Omega$       | 0       |
| RBULK0     | Bulk resistance between node BP and BI             | $\Omega$       | 0       |
| RDE        | External drain resistance                          | $\Omega$       | 0       |
| RG         | Gate resistance                                    | $\Omega$       | 0       |
| RG0        | Gate resistance                                    | $\Omega$       | 0       |
| RINT       | Contact resistance between silicide and ploy       | $\Omega - m^2$ | 0       |
| RJUND      | Drain-side bulk resistance between node BI and BD  | $\Omega$       | 0       |
| RJUNDO     | Drain-side bulk resistance between node BI and BD  | $\Omega$       | 0       |
| RJUNS      | Source-side bulk resistance between node BI and BS | $\Omega$       | 0       |
| RJUNSO     | Source-side bulk resistance between node BI and BS | $\Omega$       | 0       |
| RS         | Series resistance at TR                            | $\Omega$       | 30      |
| RSB        | Back-bias dependence of series resistance          | $V^{-1}$       | 0       |
| RSB0       | Back-bias dependence of series resistance          | $V^{-1}$       | 0       |
| RSE        | External source resistance                         | $\Omega$       | 0       |
| RSG        | Gate-bias dependence of series resistance          | $V^{-1}$       | 0       |
| RSG0       | Gate-bias dependence of series resistance          | $V^{-1}$       | 0       |
| RSH        | Sheet resistance of source diffusion               | ohm/square     | 0       |
| RSHD       | Sheet resistance of drain diffusion                | ohm/square     | 0       |
| RSHG       | Gate electrode diffusion sheet resistance          | ohm/square     | 0       |



| Parameter  | Description   | Units          | Default |
|------------|---|----------------|---------|
| RSW1       | Source/drain series resistance for 1 um wide channel at TR  | $\Omega$       | 50      |
| RSW2       | Higher-order width scaling of RS  | –              | 0       |
| RVPOLY     | Vertical poly resistance  | $\Omega - m^2$ | 0       |
| RWELL      | Well resistance between node BI and B   | $\Omega$       | 0       |
| RWELLO     | Well resistance between node BI and B   | $\Omega$       | 0       |
| SAREF      | Reference distance between OD-edge and poly from one side   | m              | 1e-06   |
| SBREF      | Reference distance between OD-edge and poly from other side   | m              | 1e-06   |
| SCREF      | Distance between OD-edge and well edge of a reference device  | m              | 1e-06   |
| STA2       | Temperature dependence of A2  | V              | 0       |
| STA20      | Temperature dependence of A2  | V              | 0       |
| STBET      | Temperature dependence of BETN  | –              | 1       |
| STBETL     | Length dependence of temperature dependence of BETN   | –              | 0       |
| STBETLW    | Area dependence of temperature dependence of BETN   | –              | 0       |
| STBETO     | Geometry independent temperature dependence of BETN   | –              | 1       |
| STBETW     | Width dependence of temperature dependence of BETN  | –              | 0       |
| STBGIDL    | Temperature dependence of BGIDL   | V/K            | 0       |
| STBGIDLD   | Temperature dependence of BGIDL for drain side  | V/K            | 0       |
| STBGIDLDO  | Temperature dependence of BGIDL for drain side  | V/K            | 0       |
| STBGIDL0   | Temperature dependence of BGIDL   | V/K            | 0       |
| STCS       | Temperature dependence of CS  | –              | 0       |
| STCS0      | Temperature dependence of CS  | –              | 0       |
| STETA0     | eta0 shift factor related to VTHO change  | m              | 0       |
| STFBBTBOT  | Temperature scaling parameter for band-to-band tunneling of bottom component for source-bulk junction | –              | -0.001  |
| STFBBTBOTD | Temperature scaling parameter for band-to-band tunneling of bottom component for drain-bulk junction  | –              | -0.001  |

| Parameter  | Description  | Units | Default |
|------------|--|-------|---------|
| STFBBTGAT  | Temperature scaling parameter for band-to-band tunneling of gate-edge component for source-bulk junction | –     | -0.001  |
| STFBBTGATD | Temperature scaling parameter for band-to-band tunneling of gate-edge component for drain-bulk junction  | –     | -0.001  |
| STFBBTSTI  | Temperature scaling parameter for band-to-band tunneling of STI-edge component for source-bulk junction  | –     | -0.001  |
| STFBBTSTID | Temperature scaling parameter for band-to-band tunneling of STI-edge component for drain-bulk junction   | –     | -0.001  |
| STIG       | Temperature dependence of IGINV and IGOV   | –     | 2       |
| STIGO      | Temperature dependence of IGINV and IGOV   | –     | 2       |
| STMUE      | Temperature dependence of MUE  | –     | 0       |
| STMUEO     | Temperature dependence of MUE  | –     | 0       |
| STRS       | Temperature dependence of RS   | –     | 1       |
| STRSO      | Temperature dependence of RS   | –     | 1       |
| STTHEMU    | Temperature dependence of THEMU  | –     | 1.5     |
| STTHEMUO   | Temperature dependence of THEMU  | –     | 1.5     |
| STTHESAT   | Temperature dependence of THESAT   | –     | 1       |
| STTHESATL  | Length dependence of temperature dependence of THESAT  | –     | 0       |
| STTHESATLW | Area dependence of temperature dependence of THESAT  | –     | 0       |
| STTHESATO  | Geometry independent temperature dependence of THESAT  | –     | 1       |
| STTHESATW  | Width dependence of temperature dependence of THESAT   | –     | 0       |
| STVFB      | Temperature dependence of VFB  | V/K   | 0.0005  |
| STVFBL     | Length dependence of temperature dependence of VFB   | V/K   | 0       |
| STVFBLW    | Area dependence of temperature dependence of VFB   | V/K   | 0       |
| STVFBO     | Geometry-independent temperature dependence of VFB   | V/K   | 0.0005  |
| STVFBW     | Width dependence of temperature dependence of VFB  | V/K   | 0       |

| Parameter  | Description  | Units    | Default |
|------------|--|----------|---------|
| STXCOR     | Temperature dependence of XCOR                           | –        | 0       |
| STXCORO    | Temperature dependence of XCOR                           | –        | 0       |
| SWDELVTAC  | Flag for separate capacitance calculation; 0=off, 1=on   | –        | 0       |
| SWGEO      | Flag for geometrical model, 0=local, 1=global, 2=binning | –        | 1       |
| SWGIDL     | Flag for GIDL current, 0=turn off IGIDL                  | –        | 0       |
| SWGATE     | Flag for gate current, 0=turn off IG                     | –        | 0       |
| SWIMPACT   | Flag for impact ionization current, 0=turn off II        | –        | 0       |
| SWJUNASYM  | Flag for asymmetric junctions; 0=symmetric, 1=asymmetric | –        | 0       |
| SWJUNCAP   | Flag for juncap, 0=turn off juncap                       | –        | 0       |
| SWJUNEXP   | Flag for JUNCAP-express; 0=full model, 1=express model   | –        | 0       |
| SWNUD      | Flag for NUD-effect; 0=off, 1=on, 2=on+CV-correction     | –        | 0       |
| THEMU      | Mobility reduction exponent at TR                        | –        | 1.5     |
| THEMUO     | Mobility reduction exponent at TR                        | –        | 1.5     |
| THESAT     | Velocity saturation parameter at TR                      | $V^{-1}$ | 1       |
| THESATB    | Back-bias dependence of velocity saturation              | $V^{-1}$ | 0       |
| THESATBO   | Back-bias dependence of velocity saturation              | $V^{-1}$ | 0       |
| THESATG    | Gate-bias dependence of velocity saturation              | $V^{-1}$ | 0       |
| THESATGO   | Gate-bias dependence of velocity saturation              | $V^{-1}$ | 0       |
| THESATL    | Length dependence of THESAT                              | $V^{-1}$ | 0.05    |
| THESATLEXP | Exponent for length dependence of THESAT                 | –        | 1       |
| THESATLW   | Area dependence of velocity saturation parameter         | –        | 0       |
| THESATO    | Geometry independent velocity saturation parameter at TR | $V^{-1}$ | 0       |
| THESATW    | Width dependence of velocity saturation parameter        | –        | 0       |
| TKUO       | Temperature dependence of KUO                            | –        | 0       |
| TOX        | Gate oxide thickness                                     | m        | 2e-09   |
| TOXO       | Gate oxide thickness                                     | m        | 2e-09   |
| TOXOV      | Overlap oxide thickness                                  | m        | 2e-09   |
| TOXOVD     | Overlap oxide thickness for drain side                   | m        | 2e-09   |

| Parameter | Description   | Units                | Default |
|-----------|---|----------------------|---------|
| TOXOVDO   | Overlap oxide thickness for drain side  | m                    | 2e-09   |
| TOXOVO    | Overlap oxide thickness   | m                    | 2e-09   |
| TR        | nominal (reference) temperature   | °C                   | 21      |
| TRJ       | reference temperature   | –                    | 21      |
| TYPE      | Channel type parameter, +1=NMOS -1=PMOS   | –                    | 1       |
| U0        | Zero-field mobility at TR   | m <sup>2</sup> /(Vs) | 0.05    |
| VBIRBOT   | Built-in voltage at the reference temperature of bottom component for source-bulk junction    | –                    | 1       |
| VBIRBOTD  | Built-in voltage at the reference temperature of bottom component for drain-bulk junction     | –                    | 1       |
| VBIRGAT   | Built-in voltage at the reference temperature of gate-edge component for source-bulk junction | –                    | 1       |
| VBIRGATD  | Built-in voltage at the reference temperature of gate-edge component for drain-bulk junction  | –                    | 1       |
| VBIRSTI   | Built-in voltage at the reference temperature of STI-edge component for source-bulk junction  | –                    | 1       |
| VBIRSTID  | Built-in voltage at the reference temperature of STI-edge component for drain-bulk junction   | –                    | 1       |
| VBRBOT    | Breakdown voltage of bottom component for source-bulk junction                                | –                    | 10      |
| VBRBOTD   | Breakdown voltage of bottom component for drain-bulk junction                                 | –                    | 10      |
| VBRGAT    | Breakdown voltage of gate-edge component for source-bulk junction                             | –                    | 10      |
| VBRGATD   | Breakdown voltage of gate-edge component for drain-bulk junction                              | –                    | 10      |
| VBRSTI    | Breakdown voltage of STI-edge component for source-bulk junction                              | –                    | 10      |
| VBRSTID   | Breakdown voltage of STI-edge component for drain-bulk junction                               | –                    | 10      |
| VFB       | Flat band voltage at TR   | V                    | -1      |
| VFBL      | Length dependence of flat-band voltage  | V                    | 0       |
| VFBLW     | Area dependence of flat-band voltage  | V                    | 0       |
| VFBO      | Geometry-independent flat-band voltage at TR  | V                    | -1      |

| Parameter | Description   | Units           | Default |
|-----------|---|-----------------|---------|
| VFBW      | Width dependence of flat-band voltage   | V               | 0       |
| VJUNREF   | Typical maximum source-bulk junction voltage; usually about 2*VSUP                | –               | 2.5     |
| VJUNREFD  | Typical maximum drain-bulk junction voltage; usually about 2*VSUP                 | –               | 2.5     |
| VNSUB     | Effective doping bias-dependence parameter  | V               | 0       |
| VNSUBO    | Effective doping bias-dependence parameter  | V               | 0       |
| VP        | CLM logarithm dependence factor   | V               | 0.05    |
| VPO       | CLM logarithmic dependence parameter  | V               | 0.05    |
| VSBNUD    | Lower Vsb value for NUD-effect  | V               | 0       |
| VSBNUDO   | Lower Vsb value for NUD-effect  | V               | 0       |
| WBET      | Characteristic width for width scaling of BETN                                    | m               | 1e-09   |
| WEB       | Coefficient for SCB   | –               | 0       |
| WEC       | Coefficient for SCC   | –               | 0       |
| WKUO      | Width dependence of KUO   | –               | 0       |
| WKVTHO    | Width dependence of KVTHO   | –               | 0       |
| WLOD      | Width parameter   | m               | 0       |
| WLODKUO   | Width parameter for UO stress effect  | –               | 0       |
| WLODVTH   | Width parameter for VTH-stress effect   | –               | 0       |
| WMAX      | Dummy parameter to label binning set  | m               | 1       |
| WMIN      | Dummy parameter to label binning set  | m               | 0       |
| WOT       | Effective channel width reduction per side  | m               | 0       |
| WSEG      | Char. length of segregation of background doping<br>NSUBO                         | m               | 1e-08   |
| WSEGP     | Char. length of segregation of pocket doping NPCK                                 | m               | 1e-08   |
| WVARL     | Length dependence of WVAR   | –               | 0       |
| WVARO     | Geom. independent difference between actual and<br>programmed field-oxide opening | m               | 0       |
| WVARW     | Width dependence of WVAR  | –               | 0       |
| XCOR      | Non-universality factor   | V <sup>-1</sup> | 0       |
| XCORL     | Length dependence of non-universality parameter                                   | –               | 0       |

| Parameter | Description  | Units    | Default |
|-----------|--|----------|---------|
| XCORLW    | Area dependence of non-universality parameter                  | –        | 0       |
| XCORO     | Geometry independent non-universality parameter                | $V^{-1}$ | 0       |
| XCORW     | Width dependence of non-universality parameter                 | –        | 0       |
| XJUNGAT   | Junction depth of gate-edge component for source-bulk junction | –        | 1e-07   |
| XJUNGATD  | Junction depth of gate-edge component for drain-bulk junction  | –        | 1e-07   |
| XJUNSTI   | Junction depth of STI-edge component for source-bulk junction  | –        | 1e-07   |
| XJUNSTID  | Junction depth of STI-edge component for drain-bulk junction   | –        | 1e-07   |

Table 2.37: PSP103VA MOSFET Device Model Parameters.

#### Model level 301 (EKV version 3.0.1)

As of Release 5.2, **Xyce** includes the EKV MOSFET model, version 3.0.1 [15][16][17], the EKV3 model. Full documentation for the EKV3 model is available on the **Xyce** web site, <http://xyce.sandia.gov>; the documentation for the EKV3 model available there may be freely redistributed. Instance and model parameters for the EKV model are given in tables 2.38 and 2.39.

The EKV3 model is developed by the EKV Team of the Electronics Laboratory-TUC (Technical University of Crete). It is included in **Xyce** under license from Technical University of Crete. The official web site of the EKV model is <http://ekv.epfl.ch/>.

| Parameter | Description                      | Units | Default |
|-----------|----------------------------------|-------|---------|
| AD        | DRAIN'S AREA                     | –     | 0       |
| AS        | SOURCE'S AREA                    | –     | 0       |
| L         | GATE'S LENGTH                    | –     | 1e-05   |
| M         | NUMBER OF DEVICES IN PARALLEL    | –     | 1       |
| NF        | NUMBER OF FINGERS                | –     | 1       |
| PD        | DRAIN'S PERIMETER                | –     | 0       |
| PS        | SOURCE'S PERIMETER               | –     | 0       |
| SA        | STI PARAMETER; DISTANCE FROM STI | –     | 0       |

| Parameter | Description                           | Units | Default |
|-----------|---------------------------------------|-------|---------|
| SB        | STI PARAMETER; DISTANCE FROM STI      | –     | 0       |
| SD        | STI PARAMETER; DISTANCE BETWEEN GATES | –     | 0       |
| W         | GATE'S WIDTH                          | –     | 1e-05   |

Table 2.38: EKV3 MOSFET Device Instance Parameters.

| Parameter | Description                                    | Units | Default |
|-----------|--|-------|---------|
| ACLM      |  | –     | 0.83    |
| AF        |  | –     | 1       |
| AGAM      |  | –     | 0       |
| AGAMMA    | MATCHING PARAMETER FOR BODY FACTOR (GAMMA)     | –     | 0       |
| AGIDL     |  | –     | 0       |
| AKP       | MATCHING PARAMETER FOR MOBILITY (KP)           | –     | 0       |
| AQMA      |  | –     | 0.5     |
| AQMI      |  | –     | 0.4     |
| AVT       |  | –     | 0       |
| AVTO      | MATCHING PARAMETER FOR THRESHOLD VOLTAGE (VTO) | –     | 0       |
| BEX       |  | –     | -1.5    |
| BGIDL     |  | –     | 2.3e+09 |
| BVD       |  | –     | 10      |
| BVS       |  | –     | 10      |
| CGBO      |  | –     | 0       |
| CGDO      |  | –     | 0       |
| CGIDL     |  | –     | 0.5     |
| CGSO      |  | –     | 0       |
| CJD       |  | –     | 0       |
| CJF       |  | –     | 0       |
| CJS       |  | –     | 0       |
| CJSWD     |  | –     | 0       |
| CJSWGD    |  | –     | 0       |

| Parameter  | Description | Units | Default |
|------------|-------------|-------|---------|
| CJSWGS     |             | –     | 0       |
| CJSWS      |             | –     | 0       |
| COX        |             | –     | 0.012   |
| DDITS      |             | –     | 0.3     |
| DELTA      |             | –     | 2       |
| DFR        |             | –     | 0.001   |
| DGAMMAEDGE |             | –     | 0       |
| DL         |             | –     | -1e-08  |
| DLC        |             | –     | 0       |
| DPHIEDGE   |             | –     | 0       |
| DW         |             | –     | -1e-08  |
| DWC        |             | –     | 0       |
| E0         |             | –     | 1e+10   |
| E1         |             | –     | 3.1e+08 |
| EB         |             | –     | 2.9e+10 |
| EF         |             | –     | 2       |
| EGIDL      |             | –     | 0.8     |
| ETA        |             | –     | 0.5     |
| ETAD       |             | –     | 1       |
| ETAQM      |             | –     | 0.75    |
| FLR        |             | –     | 0       |
| FPROUT     |             | –     | 1e+06   |
| GAMMA      |             | –     | 0.3     |
| GAMMAG     |             | –     | 4.1     |
| GAMMAGOV   |             | –     | 10      |
| GAMMAOV    |             | –     | 1.6     |
| GC         |             | –     | 1       |
| GMIN       |             | –     | 0       |
| HDIF       |             | –     | 0       |
| IBA        |             | –     | 0       |



| Parameter  | Description | Units | Default |
|------------|-------------|-------|---------|
| IBB        |             | –     | 3e+08   |
| IBBT       |             | –     | 0.0008  |
| IBN        |             | –     | 1       |
| INFO_LEVEL |             | –     | 0       |
| JSD        |             | –     | 0       |
| JSS        |             | –     | 0       |
| JSSWD      |             | –     | 0       |
| JSSWGD     |             | –     | 0       |
| JSSWGS     |             | –     | 0       |
| JSSWS      |             | –     | 0       |
| JTSD       |             | –     | 0       |
| JTSS       |             | –     | 0       |
| JTSSWD     |             | –     | 0       |
| JTSSWGD    |             | –     | 0       |
| JTSSWGS    |             | –     | 0       |
| JTSSWS     |             | –     | 0       |
| KA         |             | –     | 0       |
| KB         |             | –     | 0       |
| KETAD      |             | –     | 0       |
| KF         |             | –     | 0       |
| KG         |             | –     | 0       |
| KGAMMA     |             | –     | 0       |
| KGFN       |             | –     | 0       |
| KJF        |             | –     | 0       |
| KKP        |             | –     | 0       |
| KP         |             | –     | 0.0005  |
| KRGL1      |             | –     | 0       |
| KUCRIT     |             | –     | 0       |
| KVTO       |             | –     | 0       |
| LA         |             | –     | 1       |

| Parameter | Description | Units | Default |
|-----------|-------------|-------|---------|
| LAMBDA    |             | –     | 0.5     |
| LB        |             | –     | 1       |
| LDIF      |             | –     | 0       |
| LDPHIEDGE |             | –     | 0       |
| LDW       |             | –     | 0       |
| LETA      |             | –     | 0.5     |
| LETA0     |             | –     | 0       |
| LETA2     |             | –     | 0       |
| LGAM      |             | –     | 1       |
| LKKP      |             | –     | 0       |
| LKVTO     |             | –     | 0       |
| LL        |             | –     | 0       |
| LLN       |             | –     | 1       |
| LLODKKP   |             | –     | 1       |
| LLODKVTO  |             | –     | 1       |
| LNWR      |             | –     | 0       |
| LODKETAD  |             | –     | 1       |
| LODKGAMMA |             | –     | 1       |
| LOV       |             | –     | 2e-08   |
| LOVIG     |             | –     | 2e-08   |
| LQWR      |             | –     | 0       |
| LR        |             | –     | 5e-08   |
| LVT       |             | –     | 1       |
| LWR       |             | –     | 0       |
| MJD       |             | –     | 0.9     |
| MJS       |             | –     | 0.9     |
| MJSWD     |             | –     | 0.7     |
| MJSWGD    |             | –     | 0.7     |
| MJSWGS    |             | –     | 0.7     |
| MJSWS     |             | –     | 0.7     |

| Parameter | Description          | Units | Default |
|-----------|----------------------|-------|---------|
| NO        |                      | –     | 1       |
| NCS       |                      | –     | 1       |
| NFVTA     |                      | –     | 0       |
| NFVTB     |                      | –     | 10000   |
| NJD       |                      | –     | 1       |
| NJS       |                      | –     | 1       |
| NJTSD     |                      | –     | 1       |
| NJTSS     |                      | –     | 1       |
| NJTSSWD   |                      | –     | 1       |
| NJTSSWGD  |                      | –     | 1       |
| NJTSSWGS  |                      | –     | 1       |
| NJTSSWS   |                      | –     | 1       |
| NLR       |                      | –     | 0.01    |
| NQS_NOI   |                      | –     | 1       |
| NWR       |                      | –     | 0.005   |
| PBD       |                      | –     | 0.8     |
| PBS       |                      | –     | 0.8     |
| PBSWD     |                      | –     | 0.6     |
| PBSWGD    |                      | –     | 0.6     |
| PBSWGS    |                      | –     | 0.6     |
| PBSWS     |                      | –     | 0.6     |
| PDITS     |                      | –     | 0       |
| PDITSD    |                      | –     | 1       |
| PDITSL    |                      | –     | 0       |
| PHIF      | FERMI BULK POTENTIAL | –     | 0.45    |
| PKKP      |                      | –     | 0       |
| PKVTO     |                      | –     | 0       |
| QLR       |                      | –     | 0.0005  |
| QOFF      |                      | –     | 0       |
| QWR       |                      | –     | 0.0003  |

| Parameter | Description                           | Units | Default |
|-----------|---------------------------------------|-------|---------|
| RBN       |                                       | —     | 0       |
| RBWSH     |                                       | —     | 0.003   |
| RD        |                                       | —     | 0       |
| RDBN      |                                       | —     | 0       |
| RDBWSH    |                                       | —     | 0.001   |
| RDSBSH    |                                       | —     | 1000    |
| RDX       |                                       | —     | -1      |
| RGSH      |                                       | —     | 3       |
| RINGTYPE  |                                       | —     | 1       |
| RLX       | EXTERNAL SERIES RESISTANCE            | —     | -1      |
| RS        |                                       | —     | 0       |
| RSBN      |                                       | —     | 0       |
| RSBWSH    |                                       | —     | 0.001   |
| RSH       |                                       | —     | 0       |
| RSX       |                                       | —     | -1      |
| SAREF     |                                       | —     | 0       |
| SBREF     |                                       | —     | 0       |
| SCALE     |                                       | —     | 1       |
| SIGMAD    |                                       | —     | 1       |
| SIGN      | SIGN = 1 FOR NMOS; SIGN = -1 FOR PMOS | —     | 1       |
| TCJ       |                                       | —     | 0       |
| TCJSW     |                                       | —     | 0       |
| TCJSWG    |                                       | —     | 0       |
| TCV       |                                       | —     | 0.0006  |
| TCVL      |                                       | —     | 0       |
| TCVW      |                                       | —     | 0       |
| TCVWL     |                                       | —     | 0       |
| TEOEX     |                                       | —     | 0.5     |
| TE1EX     |                                       | —     | 0.5     |
| TETA      |                                       | —     | -0.0009 |

| Parameter | Description   | Units | Default |
|-----------|---|-------|---------|
| TG        | TYPE OF GATE: -1 ENHANCEMENT TYPE; 1 DEPLETION TYPE | –     | -1      |
| THC       |   | –     | 0       |
| TH_NOI    |   | –     | 0       |
| TKKP      |   | –     | 0       |
| TLAMBDA   |   | –     | 0       |
| TNJTSD    |   | –     | 0       |
| TNJTSS    |   | –     | 0       |
| TNJTSSWD  |   | –     | 0       |
| TNJTSSWGD |   | –     | 0       |
| TNJTSSWGS |   | –     | 0       |
| TNJTSSWS  |   | –     | 0       |
| TNOM      |   | –     | -246.15 |
| TPB       |   | –     | 0       |
| TPBSW     |   | –     | 0       |
| TPBSWG    |   | –     | 0       |
| TR        |   | –     | 0       |
| TR2       |   | –     | 0       |
| UCEX      |   | –     | 1.5     |
| UCRIT     |   | –     | 5e+06   |
| VBI       |   | –     | 0       |
| VFBOV     |   | –     | 0       |
| VFR       |   | –     | 0       |
| VOV       |   | –     | 1       |
| VT0       | THRESHOLD VOLTAGE                                   | –     | 0.3     |
| VTSD      |   | –     | 0       |
| VTSS      |   | –     | 0       |
| VTSSWD    |   | –     | 0       |
| VTSSWGD   |   | –     | 0       |
| VTSSWGS   |   | –     | 0       |

| Parameter    | Description | Units | Default |
|--------------|-------------|-------|---------|
| VTSSWS       |             | –     | 0       |
| WDL          |             | –     | 0       |
| WDPHIEDGE    |             | –     | 0       |
| WEO          |             | –     | 0       |
| WE1          |             | –     | 0       |
| WEDGE        |             | –     | 0       |
| WETA         |             | –     | 0.2     |
| WETAD        |             | –     | 0       |
| WGAM         |             | –     | 1       |
| WKKP         |             | –     | 0       |
| WKP1         |             | –     | 1e-06   |
| WKP2         |             | –     | 0       |
| WKP3         |             | –     | 1       |
| WKVTO        |             | –     | 0       |
| WLAMBDA      |             | –     | 0       |
| WLDGAMMAEDGE |             | –     | 0       |
| WLDPHIEDGE   |             | –     | 0       |
| WLOD         |             | –     | 0       |
| WLODKKP      |             | –     | 1       |
| WLODKVTO     |             | –     | 1       |
| WLR          |             | –     | 0       |
| WNLR         |             | –     | 0       |
| WQLR         |             | –     | 0       |
| WR           |             | –     | 9e-08   |
| WRLX         |             | –     | 0       |
| WUCEX        |             | –     | 0       |
| WUCRIT       |             | –     | 0       |
| WVT          |             | –     | 1       |
| XB           |             | –     | 3.1     |
| XJ           |             | –     | 2e-08   |

| Parameter | Description | Units | Default |
|-----------|-------------|-------|---------|
| XJBVD     |             | –     | 0       |
| XJBVS     |             | –     | 0       |
| XL        |             | –     | 0       |
| XTID      |             | –     | 3       |
| XTIS      |             | –     | 3       |
| XTSD      |             | –     | 0       |
| XTSS      |             | –     | 0       |
| XTSSWD    |             | –     | 0       |
| XTSSWGD   |             | –     | 0       |
| XTSSWGS   |             | –     | 0       |
| XTSSWS    |             | –     | 0       |
| XW        |             | –     | 0       |
| ZC        |             | –     | 1e-06   |

Table 2.39: EKV3 MOSFET Device Model Parameters.

## Quadratic Temperature Compensation

Spice temperature effects are default, but MOSFET levels 18, 19 and 20 have a more advanced temperature compensation available. By specifying `TEMPMODEL=QUADRATIC` in the netlist, parameters can be interpolated quadratically between measured values extracted from data. See Section 5.3 of the User's Guide for more details.

## MOSFET Equations

The following equations define an N-channel MOSFET. The P-channel devices use a reverse the sign for all voltages and currents. The equations use the following variables:

$$\begin{aligned}
 V_{bs} &= \text{intrinsic substrate-intrinsic source voltage} \\
 V_{bd} &= \text{intrinsic substrate-intrinsic drain voltage} \\
 V_{ds} &= \text{intrinsic drain-substrate source voltage} \\
 V_{dsat} &= \text{saturation voltage} \\
 V_{gs} &= \text{intrinsic gate-intrinsic source voltage} \\
 V_{gd} &= \text{intrinsic gate-intrinsic drain voltage} \\
 V_t &= kT/q \text{ (thermal voltage)}
 \end{aligned}$$

|           |   |   |
|-----------|---|---|
| $V_{th}$  | = | threshold voltage                           |
| $C_{ox}$  | = | the gate oxide capacitance per unit area    |
| $f$       | = | noise frequency                             |
| $k$       | = | Boltzmann's constant                        |
| $q$       | = | electron charge                             |
| $L_{eff}$ | = | effective channel length                    |
| $W_{eff}$ | = | effective channel width                     |
| $T$       | = | analysis temperature ( $^{\circ}K$ )        |
| $T_0$     | = | nominal temperature (set using TNOM option) |

Other variables are listed in the BJT Model Parameters Table 2.20.



## All Levels

$$I_g = \text{gate current} = 0$$

$$I_b = \text{bulk current} = I_{bs} + I_{bd}$$

where

$$I_{bs} = \text{bulk-source leakage current} = I_{ss} \left( e^{V_{bs}/(NV_t)} - 1 \right)$$

$$I_{ds} = \text{bulk-drain leakage current} = I_{ds} \left( e^{V_{bd}/(NV_t)} - 1 \right)$$

where

if

$$\mathbf{JS} = 0, \text{ or } \mathbf{AS} = 0 \text{ or } \mathbf{AD} = 0$$

then

$$I_{ss} = \mathbf{IS}$$

$$I_{ds} = \mathbf{IS}$$

else

$$I_{ss} = \mathbf{AS} \times \mathbf{JS} + \mathbf{PS} \times \mathbf{JSSW}$$

$$I_{ds} = \mathbf{AD} \times \mathbf{JS} + \mathbf{PD} \times \mathbf{JSSW}$$

$$I_d = \text{drain current} = I_{drain} - I_{bd}$$

$$I_s = \text{source current} = -I_{drain} - I_{bs}$$

## Level 1: Idrain

**Normal Mode:**  $V_{ds} > 0$

**Case 1**

For cutoff region:  $V_{gs} - V_{to} < 0$

$$I_{drain} = 0$$

**Case 2**

For linear region:  $V_{ds} < V_{gs} - V_{to}$

$$I_{drain} = (W/L)(KN/2)(1 + LAMBDA \times V_{ds})V_{ds}(2(V_{gs} - V_{to}) - V_{ds})$$

**Case 3**

For saturation region:  $0 \leq V_{gs} - V_{to} \leq V_{ds}$

$$I_{drain} = (W/L)(KN/2)(1 + LAMBDA \cdot V_{ds})(V_{gs} - V_{to})^2$$

where

$$V_{to} = VTO + GAMMA \cdot \left( (PHI - V_{bs})^{1/2} \right)^{1/2}$$

**Inverted Mode:**  $V_{ds} < 0$

Here, simply switch the source and drain in the normal mode equations given above.

**Level 3: Idrain**

See Reference [18] below for detailed information.

## Capacitance

**Level 1 and 3**

$C_{bs}$  = bulk-source capacitance = area cap. + sidewall cap. + transit time cap.

$C_{bd}$  = bulk-drain capacitance = area cap. + sidewall cap. + transit time cap.

where

*if*

$$\mathbf{CBS} = 0 \text{ and } \mathbf{CBD} = 0$$

*then*

$$C_{bs} = \mathbf{AS} \cdot \mathbf{CJ} \cdot C_{bsj} + \mathbf{PS} \cdot \mathbf{CJSW} \cdot C_{bss} + \mathbf{TT} \cdot G_{bs}$$

$$C_{bd} = \mathbf{AD} \cdot \mathbf{CJ} \cdot C_{bdj} + \mathbf{PD} \cdot \mathbf{CJSW} \cdot C_{bds} + \mathbf{TT} \cdot G_{ds}$$

*else*

$$C_{bs} = \mathbf{CBS} \cdot C_{bsj} + \mathbf{PS} \cdot \mathbf{CJSW} \cdot C_{bss} + \mathbf{TT} \cdot G_{bs}$$

$$C_{bd} = \mathbf{CBD} \cdot C_{bdj} + \mathbf{PD} \cdot \mathbf{CJSW} \cdot C_{bds} + \mathbf{TT} \cdot G_{ds}$$

*where*

$$G_{bs} = \text{DC bulk-source conductance} = dI_{bs}/dV_{bs}$$

$$G_{bd} = \text{DC bulk-drain conductance} = dI_{bd}/dV_{bd}$$

*if*

$$V_{bs} \leq \mathbf{FC} \cdot \mathbf{PB}$$

*then*

$$C_{bsj} = (1 - V_{bs}/\mathbf{PB})^{-\mathbf{MJ}}$$

$$C_{bss} = (1 - V_{bs}/\mathbf{PBSW})^{-\mathbf{MJSW}}$$

*if*

$$V_{bs} > \mathbf{FC} \cdot \mathbf{PB}$$

*then*

$$C_{bsj} = (1 - \mathbf{FC})^{-(1+\mathbf{MJ})} (1 - \mathbf{FC}(1 + \mathbf{MJ}) + \mathbf{MJ} \cdot V_{bs}/\mathbf{PB})$$

$$C_{bss} = (1 - \mathbf{FC})^{-(1+\mathbf{MJSW})} (1 - \mathbf{FC}(1 + \mathbf{MJSW}) + \mathbf{MJSW} \cdot V_{bs}/\mathbf{PBSW})$$

*if*

$$V_{bd} \leq \mathbf{FC} \cdot \mathbf{PB}$$

*then*

$$C_{bdj} = (1 - V_{bd}/\mathbf{PB})^{-\mathbf{MJ}}$$

$$C_{bds} = (1 - V_{bd}/\mathbf{PBSW})^{-\mathbf{MJSW}}$$

*if*

$$V_{bd} > \mathbf{FC} \cdot \mathbf{PB}$$

*then*

$$C_{bdj} = (1 - \mathbf{FC})^{-(1+\mathbf{MJ})} (1 - \mathbf{FC}(1 + \mathbf{MJ}) + \mathbf{MJ} \cdot V_{bd}/\mathbf{PB})$$

$$C_{bds} = (1 - \mathbf{FC})^{-(1+\mathbf{MJSW})} (1 - \mathbf{FC}(1 + \mathbf{MJSW}))$$

$$C_{gs} = \text{gate-source overlap capacitance} = \mathbf{CGSO} \cdot \mathbf{W}$$

$$C_{gd} = \text{gate-drain overlap capacitance} = \mathbf{CGDO} \cdot \mathbf{W}$$

$$C_{gb} = \text{gate-bulk overlap capacitance} = \mathbf{CGBO} \cdot \mathbf{L}$$

## Temperature Effects

### All Levels

$$\mathbf{IS}(T) = \mathbf{IS} \cdot \exp(E_g(T_0) \cdot T/T_0 - E_g(T)) / V_t$$

$$\mathbf{JS}(T) = \mathbf{JS} \cdot \exp(E_g(T_0) \cdot T/T_0 - E_g(T)) / V_t$$

$$\mathbf{JSSW}(T) = \mathbf{JSSW} \cdot \exp(E_g(T_0) \cdot T/T_0 - E_g(T)) / V_t$$

$$\mathbf{PB}(T) = \mathbf{PB} \cdot T/T_0 - 3V_t \ln(T/T_0) - E_g(T_0) \cdot T/T_0 + E_g T$$

$$\mathbf{PBSW}(T) = \mathbf{PBSW} \cdot T/T_0 - 3V_t \ln(T/T_0) - E_g(T_0) \cdot T/T_0 + E_g T$$

$$\mathbf{PHI}(T) = \mathbf{PHI} \cdot T/T_0 - 3V_t \ln(T/T_0) - E_g(T_0) \cdot T/T_0 + E_g T$$

where

$$E_g(T) = \text{silicon bandgap energy} = 1.16 - 0.000702T^2/(T + 1108)$$

$$\mathbf{CBD}(T) = \mathbf{CBD} \cdot (1 + \mathbf{MJ} \cdot (0.0004(T - T_0) + (1 - \mathbf{PB}(T)/\mathbf{PB})))$$

$$\mathbf{CBS}(T) = \mathbf{CBS} \cdot (1 + \mathbf{MJ} \cdot (0.0004(T - T_0) + (1 - \mathbf{PB}(T)/\mathbf{PB})))$$

$$\mathbf{CJ}(T) = \mathbf{CJ} \cdot (1 + \mathbf{MJ} \cdot (0.0004(T - T_0) + (1 - \mathbf{PB}(T)/\mathbf{PB})))$$

$$\mathbf{CJSW}(T) = \mathbf{CJSW} \cdot (1 + \mathbf{MJSW} \cdot (0.0004(T - T_0) + (1 - \mathbf{PB}(T)/\mathbf{PB})))$$

$$\mathbf{KP}(T) = \mathbf{KP} \cdot (T/T_0)^{-3/2}$$

$$\mathbf{UO}(T) = \mathbf{UO} \cdot (T/T_0)^{-3/2}$$

$$\mathbf{MUS}(T) = \mathbf{MUS} \cdot (T/T_0)^{-3/2}$$

$$\mathbf{MUZ}(T) = \mathbf{MUZ} \cdot (T/T_0)^{-3/2}$$

$$\mathbf{X3MS}(T) = \mathbf{X3MS} \cdot (T/T_0)^{-3/2}$$

For a thorough description of MOSFET models see [19, 18, 20, 21, 22, 9, 10, 23, 24, 15].

For complete documentation of the BSIM3 model, see the users' manual for the BSIM3, available for download at <http://www-device.eecs.berkeley.edu/~bsim3/get.html>. Xyce implements Version 3.2.2 of the BSIM3, you will have to get the documentation from the FTP archive on the Berkeley site.

For complete documentation of the BSIMSOI model, see the users' manual for the BSIMSOI, available for download at <http://www-device.eecs.berkeley.edu/~bsimsoi/>. Xyce implements Version 3.2 of the BSIMSOI, you will have to get the documentation from the FTP archive on the Berkeley site.

For complete documentation of the BSIM4 model, see the users' manual for the BSIM4,

available for download at <http://www-device.eecs.berkeley.edu/~bsim3/bsim4.html>.  
**Xyce** implements Version 4.6.1 of the BIMS4, you will have to get the documentation from the FTP archive on the Berkeley site.

## Voltage- or Current-controlled Switch

---

**General Form** S<name> <(+) switch node> <(-) switch node>  
+ <(+) control node> <(-) control node>  
+ <model name> [ON] [OFF]

W<name> <(+) switch node> <(-) switch node>  
+ <control node voltage source>  
+ <model name> [ON] [OFF]

---

**Examples**

```
S1 21 23 12 10 SMOD1
SSET 15 10 1 13 SRELAY
W1 1 2 VCLOCK SWITCHMOD1
W2 3 0 VRAMP SM1 ON
```

---

**Model Form** .MODEL <model name> VSWITCH [model parameters]  
.MODEL <model name> ISWITCH [model parameters]

---

**Description** The voltage- or current-controlled switch is a particular type of controlled resistor. This model is designed to help reduce numerical issues. See Special considerations below.

---

---

The resistance between the <(+) switch node> and the <(-) switch node> is dependent on either the voltage between the <(+) control node> and the <(-) control node> or the current through the control node voltage source. The resistance changes in a continuous manner between the **RON** and **ROFF** model parameters.

No resistance is inserted between the control nodes. It is up to the user to make sure that these nodes are not floating.

### Comments

Even though evaluating the switch model is computationally inexpensive, for transient analysis, **Xyce** steps through the transition section using small time-steps in order to calculate the waveform accurately. Thus, a circuit with many switch transitions can result in lengthy run times.

The **ON** and **OFF** parameters are used to specify the initial state of the switch at the first step of the operating point calculation; this does not force the switch to be in that state, it only gives the operating point solver an initial state to work with. If it is known that the switch should be in a particular state in the operating point it could help convergence to specify one of these keywords.

---

## Model Parameters

Table 2.40 gives the available model parameters for the voltage- or current-controlled switch.

## Special Considerations

- Due to numerical limitations, **Xyce** can only manage a dynamic range of approximately 12 decades. Thus, it is recommended the user limit the ratio **ROFF/RON** to less than  $10^{12}$ .
- Furthermore, it is a good idea to limit the narrowness of the transition region. This is because in the transition region, the switch has gain and the narrower the region, the higher the gain and the more potential for numerical problems. The smallest value allowed for  $\|VON - VOFF\|$  or  $\|ION - IOFF\|$  is  $1 \times 10^{-12}$ .

| Model parameters | Description                   | Units | Default            |
|------------------|-------------------------------|-------|--------------------|
| ROFF             | Off Resistance                | ohm   | $1.0 \times 10^6$  |
| RON              | On Resistance                 | ohm   | 1.0                |
| VOFF             | Control Voltage for Off State | volt  | 0.0                |
| VON              | Control Voltage for On State  | volt  | 1.0                |
| IOFF             | Control Current for Off State | amp   | 0.0                |
| ION              | Control Current for On State  | amp   | $1 \times 10^{-3}$ |
| OFF              | Control for Off State         |       |                    |
| ON               | Control for On State          |       |                    |

**Table 2.40.** Controlled Switch Model Parameters.

### Controlled switch equations

The equations in this section use the following variables:

- $R_s$  = switch resistance
- $V_c$  = voltage across control nodes
- $I_c$  = current through control node voltage source
- $L_m$  = log-mean of resistor values =  $\ln(\sqrt{\mathbf{RON} \cdot \mathbf{ROFF}})$
- $L_r$  = log - ratio of resistor values =  $\ln(\mathbf{RON}/\mathbf{ROFF})$
- $V_d$  = difference of control voltages =  $\mathbf{VON} - \mathbf{VOFF}$
- $I_d$  = difference of control currents =  $\mathbf{ION} - \mathbf{IOFF}$

#### Switch Resistance

To compute the switch resistance, **Xyce** first calculates the “switch state”  $S$  as  $S = (V_c - \mathbf{VOFF})/V_d$  or  $S = (I_c - \mathbf{IOFF})/I_d$ . The switch resistance is then:

$$R_s = \begin{cases} \mathbf{RON}, & S \geq 1.0 \\ \mathbf{ROFF}, & S \leq 0.0 \\ \exp(L_m + 0.75L_r(2S - 1) - 0.25L_r(2S - 1)^3), & 0 < S < 1 \end{cases}$$



## Generic Switch

---

**General Form** SW<name> <(+) switch node> <(-) switch node>  
 + <model name> [ON] [OFF] <control = { expression }>

---

**Examples**

```
SW 1 2 SWI OFF CONTROL={I(VMON)}
SW 1 2 SWV OFF CONTROL={V(3)-V(4)}
SW 1 2 SW OFF CONTROL={if(time>0.001,1,0)}
```

---

**Model Form**

```
.MODEL <model name> VSWITCH [model parameters]
.MODEL <model name> ISWITCH [model parameters]
.MODEL <model name> SWITCH [model parameters]
```

---

**Description**

The generic switch is similar to the voltage- or current-controlled switch except that the control variable is anything that can be written as an expression. The examples show how a voltage- or current-controlled switch can be implemented with the generic switch. Also shown is a relay that turns on when a certain time is reached. Model parameters are given in Table 2.40.

---

## Lossless (Ideal) Transmission Line

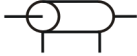
|                     |   |
|---------------------|---|
|                     | T<name> <A port (+) node> <A port (-) node>   |
| <b>General Form</b> | + <B port (+) node> <B port (-) node> [model name]<br>+ Z0=<value> [TD=<value>] [F=<value> [NL=<value>]]  |
| <b>Examples</b>     | Tline inp inn outp outn Z0=50 TD=1us<br>Tline2 inp inn outp outn Z0=50 F=1meg NL=1.0  |
| <b>Symbol</b>       |    |
| <b>Description</b>  | The lossless transmission line device is a two port (A and B), bi-directional delay line. The (+) and (-) nodes define the polarity of a positive voltage at a port.  |
| <b>Comments</b>     | Z0 is the characteristic impedance. The transmission line's length is specified by either TD (a delay in seconds) or by F and NL (a frequency and relative wavelength at F). NL defaults to 0.25 (F is the quarter-wave frequency). If F is given, the time delay is computed as $\frac{NL}{F}$ . While both TD and F are optional, at least one of them must be given. |

### Model Parameters

Table 2.41 gives the available model parameters for the lossless transmission line.

| Model parameters | Description              | Units  | Default |
|------------------|--------------------------|--------|---------|
| Z0               | Characteristic impedance | ohm    | -       |
| TD               | Transmission delay       | second | -       |
| F                | Frequency for <b>NL</b>  | Hz     | -       |
| NL               | Relative wavelength      | -      | 0.25    |

**Table 2.41.** Lossless (Ideal) Transmission Line Parameters.

## Behavioral Digital Devices

---

|                     |  |
|---------------------|--|
| <b>General Form</b> | Y<type> <name> [low output node] [high output node]<br>[input reference node] <input node(s)> <output node(s)><br><model name> [device parameters] |
|---------------------|--|

---

|                 |  |
|-----------------|--|
| <b>Examples</b> | <pre> YAND MYAND in1 in2 out DMOD IC=1 YNOT THENOT in out DMOD YNOR ANOR2 vlo vhi vref in1 in2 out DDEF .model DMOD DIG ( + CLO=1e-12 CHI=1e-12 + SORLO=5 SORHI=5 SOTSW=5e-9 + SOVLO=-1 SOVHI=1.8 + S1RLO=200 S1RHI=5 S1TSW=5e-9 + S1VLO=1 S1VHI=3 + RLOAD=1000 + CLOAD=1e-12 + VREF=0 VLO=0 VHI=3 + DELAY=20ns ) .MODEL DDEF DIG </pre> |
|-----------------|--|

---

|                   |  |
|-------------------|--|
| <b>Model Form</b> | .MODEL <model name> DIG [model parameters] |
|-------------------|--|

---

---

<type>

Type of digital device. Supported devices are: NOT, AND, NAND, OR, NOR, XOR, NXOR, and ADD. All have two input nodes and one output node, except NOT, which has only one input node and 1 output and ADD which has 3 input and two output.

<name>

Name of the device instance. This must be present, and when combined with the Y<type>, must be unique in the netlist. In the examples, MYAND, THENOT and ANOR2 have been used as names for the three devices.

[low output node]

Dominant node to be connected to the output node(s) to establish low output state. This node is connected to the output by a resistor and capacitor in parallel, whose values are set by the model. If specified by the model, this node can be omitted and a fixed voltage is used instead.

[high output node]

Dominant node to be connected to the output node(s) to establish high output state. This node is connected to the output by a resistor and capacitor in parallel, whose values are set by the model. If specified by the model, this node can be omitted and a fixed voltage is used instead.

[input reference node]

This node is connected to the input node by a resistor and capacitor in parallel, whose values are set by the model. Determination if the input state is based on the voltage drop between the input node and this node. If specified by the model, this node can be omitted and a fixed voltage is used instead.

<input and output nodes>

Nodes that connect to the circuit.

<model name>

Name of the model defined in a .MODEL line.

## **Parameters and Options**

[device parameters]

### Parameters and Options

Parameter listed in Table 2.42 may be provided as <parameter>=<value> specifications as needed. For devices with more than one output, multiple output initial states may be provided as a comma separated list (e.g. IC=T,F).

## Device Parameters

Table 2.42 gives the available device parameters for the behavioral digital devices.

| Parameter | Description                            | Units         | Default |
|-----------|--|---------------|---------|
| IC        | Vector of initial values for output(s) | logical (T/F) | False   |

Table 2.42: Behavioral Digital Device Parameters.

## Model Parameters

Table 2.43 gives the available model parameters for the behavioral digital devices.

| Parameter | Description  | Units    | Default |
|-----------|--|----------|---------|
| CHI       | Capacitance between output node and high reference           | F        | 1e-06   |
| CLO       | Capacitance between output node and low reference            | F        | 1e-06   |
| CLOAD     | Capacitance between input node and input reference           | F        | 1e-06   |
| DELAY     | Delay time of device   | s        | 1e-08   |
| RLOAD     | Resistance between input node and input reference            | $\Omega$ | 1000    |
| SORHI     | Low state resistance between output node and high reference  | $\Omega$ | 100     |
| SORLO     | Low state resistance between output node and low reference   | $\Omega$ | 100     |
| SOTSW     | Switching time transition to low state                       | s        | 1e-08   |
| SOVHI     | Maximum voltage to switch to low state                       | V        | 1.7     |
| SOVLO     | Minimum voltage to switch to low state                       | V        | -1.5    |
| S1RHI     | High state resistance between output node and high reference | $\Omega$ | 100     |

| Parameter | Description   | Units    | Default |
|-----------|---|----------|---------|
| S1RLO     | High state resistance between output node and low reference | $\Omega$ | 100     |
| S1TSW     | Switching time transition to high state                     | s        | 1e-08   |
| S1VHI     | Maximum voltage to switch to high state                     | V        | 7       |
| S1VLO     | Minimum voltage to switch to high state                     | V        | 0.9     |
| VHI       | Internal high state supply voltage                          | V        | 0       |
| VLO       | Internal low state supply voltage                           | V        | 0       |
| VREF      | Internal reference voltage for inputs                       | V        | 0       |

Table 2.43: Behavioral Digital Model Parameters.

## Model Description

The input interface model consists of the input node connected with a resistor and capacitor in parallel to the input reference node. The values of these are: RLOAD and CLOAD. If the model parameter VREF is specified, then the input reference node is not given, and an internal node of fixed voltage, VREF, is used instead.

The logical state of any input node is determined by comparing the voltage relative to the reference to the range for the low and high state. The range for the low state is S0VLO to S0VHI. Similarly, the range for the high state is S1VLO to S1VHI. The state of the input node will remain fixed as long as the voltage stays within the range for the current state. Only when it goes outside the range will transition to the other state be considered.

The output interface model is more complex than the input model, but shares the same basic configuration of a resistor and capacitor in parallel to simulate loading. For the output case, there are such connections to two nodes, the low output node and the high output node. Either or both of these can be omitted if the VLO and/or VHI model parameters are specified. Specifying either of these causes a fixed voltage node to be used in place of an externally connected node, like in the input case.

The capacitance to the high node is specified by CHI, and the capacitance to the low node is CLO. The resistors in parallel with these capacitors are variable, and have values that depend on the state. In the low state (S0), the resistance values are: S0RLO and S0RHI. In the high state (S1), the resistance values are: S1RLO and S1RHI. Transition to the high state occurs exponentially over a time of S1TSW, and to the low state S0TSW.

Delay of the device is given by the model parameter DELAY.

## Accelerated mass

Simulation of electromechanical devices or magnetically driven machines may require that **Xyce** simulate the movement of an accelerated mass, that is, to solve the second order initial value problem

$$\begin{aligned}\frac{d^2x}{dt^2} &= a(t) \\ x(0) &= x_0 \\ \dot{x}_0 &= v_0\end{aligned}$$

where  $x$  is the position of the object,  $\dot{x}$  its velocity, and  $a(t)$  the acceleration. As of **Xyce** Release 4.1, this simulation capability is provided by the accelerated mass device.

---

**General Form**    YACC <name> <acceleration node> <velocity node> <position node>  
+ [v0=<initial velocity>] [x0=<initial position>]

---

### Examples

```
*Simulate a projectile thrown upward against gravity
V1 acc 0 -9.8
R1 acc 0 1
YACC acc1 acc vel pos v0=10 x0=0
.print tran v(pos)
.tran 1u 10s
.end

*simulate a damped, forced harmonic oscillator
* assuming K, c, mass, amplitude and frequency defined in
.param statements
B1 acc 0 V={(-K*v(pos)-c*v(vel))/mass+amplitude*sin(frequency*TIME)}
```

```
R1 acc 0 1
YACC acc2 acc vel pos v0=0 x0=.4
.print tran v(pos)
.tran 1u 10s
.end
```

### Comments

---

When used as in the examples, **Xyce** will emit warning messages about the `pos` and `vel` nodes not having a DC path to ground. This is normal and should be ignored. In future versions of **Xyce** this warning will not be printed, as the condition it warns of is inconsequential in this instance. The position and velocity nodes should not be connected to any real circuit elements. Their values may, however, be used in behavioral sources; this is done in the second example.

---

## Subcircuit

A subcircuit can be introduced into the circuit netlist using the specified nodes to substitute for the argument nodes in the definition. It provides a building block of circuitry to be defined a single time and subsequently used multiple times in the overall circuit netlists.

---

**General Form**    X<name> [node]\* <subcircuit name> [PARAMS: [<name> = <value>]\*]

---

**Examples**

```
X12 100 101 200 201 DIFFAMP
XBUFF 13 15 UNITAMP
XFOLLOW IN OUT VCC VEE OUT OPAMP
XFELT 1 2 FILTER PARAMS: CENTER=200kHz
XNANDI 25 28 7 MYPWR MYGND PARAMS: IO_LEVEL=2
```

**Parameters and Options**

---

<subcircuit name>  
     The name of the subcircuit's definition.

PARAMS:  
     Passed into subcircuits as arguments and into expressions inside the subcircuit.

---

**Comments**

There must be an equal number of nodes in the subcircuit call and in its definition.

Subcircuit references may be nested to any level. However, the nesting cannot be circular. For example, if subcircuit A's definition includes a call to subcircuit B, then subcircuit B's definition cannot include a call to subcircuit A.

---



## 2.3 TCAD Devices

Semiconductor device simulation, which is based on a coupled set of partial differential equations (PDE's) is supported in **Xyce**. Such devices can be invoked from the circuit netlist, in a similar manner to traditional SPICE-style analog devices. One dimensional and two dimensional devices are supported, with the dimensionality determined by the device model level.

---

**General Form, 1D:**

```
YPDE <name> <node> [node] [model name]
[na=<value>] [nd=<value>] [nx=<value>] [area=<value>]
[graded=<value>] [wj=<value>] [l=<value>] [w=<value>]
[tecplotlevel=<value>] [sgplotlevel=<value>]
[gnuplotlevel=<value>] [node=<tabular data>]
[region=<tabular data>] [bulkmaterial=<string>]
[temp=<value>]
```

---

**General Form, 2D:**

```
YPDE <name> <node> <node> [node][node] [model name]
[na=<value>] [nd=<value>] [meshfile=<filename.msh>]
[nx=<value>] [ny=<value>] [l=<value>] [w=<value>]
[type=<string>] [node=<tabular data>]
[region=<tabular data>] [x0=<value>] [cyl=<value>]
[tecplotlevel=<value>] [sgplotlevel=<value>]
[gnuplotlevel=<value>] [txtdatalevel=<value>]
[ph.a1=<value>] [ph.type=<string>]
[ph.tstart=<value>] [ph.tstop=<value>] [photogen=<value>]
[ph.td=<value>] [ph.tr=<value>]
[ph.tf=<value>] [ph.pw=<value>] [ph.per=<value>]
[bulkmaterial=<string>] [temp=<value>]
```

---

**Comments:** Most of the PDE parameters are specified on the instance level. At this point the model statement is only used for specifying if the device is 1D or 2D, via the level parameter. Both the 1D and the 2D devices can construct evenly spaced meshes, internally. The 2D device also has the option of reading in an unstructured mesh from an external mesh file.

The electrode tabular data specification is explained in detail in table 2.48. Similarly, the doping region tabular data specification is explained in detail in table 2.46.

---

## TCAD Device Parameters

Most TCAD device parameters are specified on the instance level.

| Instance parameters | Description  | Units | Default | Device Type |
|---------------------|--|-------|---------|-------------|
| <i>All Levels</i>   |  |       |         |             |
| name                | The instance name must start with a Z.   | -     | -       | 1D,<br>2D   |
| node                | Minimum of 2 connecting circuit nodes.<br>The 2D device may have as many as 4 nodes, while the 1D device can only have 2. The node parameter is a tabular parameter, which specifies all the electrode attributes. See table 2.48 for a list.                            | -     | -       | 1D,<br>2D   |
| region              | Specifies doping regions. Like the node parameter, this is a tabular parameter, containing several attributes.. See table 2.46 for a list.   | -     | -       | 1D,<br>2D   |
| area                | Cross sectional area of the device.  | -     | 1.0     | 1D,<br>2D   |
| tecplotlevel        | Setting for Tecplot output:<br>0 - no Tecplot files<br>1 - Tecplot files, each output in a separate file.<br>2 - Tecplot file, each output appended to a single file.<br>Tecplot files will have the .dat suffix, and the prefix will be the name of the device instance | -     | 1       | 1D,<br>2D   |
| sgplotlevel         | Flag for sgplot output.<br>0 - no sgplot files.<br>1 - sgplot files.<br>sgplot is a plotting program that comes as part of the SG Framework [25]. sgplot files will have the *.res suffix, and the prefix will be the name of the device instance                        | -     | 0       | 1D,<br>2D   |

| Instance parameters             | Description  | Units | Default | Device Type |
|---------------------------------|--|-------|---------|-------------|
| gnuplotlevel                    | Flag for gnuplot output.<br>0 - no gnuplot files.<br>1 - gnuplot files.<br>gnuplot is an open source plotting program that is usually installed on Linux systems. gnuplot files will have the *Gnu.dat suffix, and the prefix will be the name of the device instance. | -     | 0       | 1D,<br>2D   |
| txtdatalevel                    | Flag for volume-averaged text output.<br>0 - no text files.<br>1 - text files.<br>txtdataplot files will have the *.txt suffix, and the prefix will be the name of the device instance.  | -     | 0       | 2D          |
| bulkmaterial                    | Material of bulk material.   | -     | si      | 1D,<br>2D   |
| mobmodel                        | mobility model.  | -     | carr    | 1D,<br>2D   |
| type                            | P-type or N-type - this is only relevant if using the default dopings  | -     | PNP     | 1D,<br>2D   |
| temp                            | Temperature  | K     | 300.15  | 1D,<br>2D   |
| nx                              | Number of mesh points, x-direction.  | -     | 11      | 1D,<br>2D   |
| l, w                            | Device length and width. These parameters mean the same thing for the 1D device.   | -     | 1.0e-3  | 1D,2D       |
| graded                          | Flag for graded junction vs. abrupt junction. (1=graded, 0=abrupt)   | -     | 0       | 1D          |
| wj                              | Junction width.  | -     | 1.0e-4  | 1D          |
| <b><i>Level 2 (2D) only</i></b> |  |       |         |             |
| ny                              | Number of mesh points, y-direction.<br>Similar to nx (see above).  | -     | 11      | 2D          |

| Instance parameters | Description  | Units | Default              | Device Type |
|---------------------|--|-------|----------------------|-------------|
| meshfile            | <p>This is a required field for a 2D simulation. If the user specifies <code>meshfile = internal.mesh</code>, then <b>Xyce</b> will create a cartesian mesh.</p> <p>If the user specifies anything else (for example <code>meshfile = diode.msh</code>), <b>Xyce</b> will attempt to read in an external mesh file (in the example, named <code>diode.msh</code>) which is in the format of the SG Framework [25].</p> | -     | -                    | 2D          |
| x0                  | <p>This is the scaling factor for length. The code will do all of its scaling internally, so it is generally not necessary to specify it manually. This is provided primarily for testing purposes.</p>  | -     | max length of device | 2D          |

Table 2.44: PDE Device Instance Parameters.



There is only one TCAD device model parameter, the level.

| Model parameters | Description  | Units | Default |
|------------------|--|-------|---------|
| LEVEL            | The level determines if this is a 1D or a 2D device. 1=1D, 2=2D. | -     | 1       |

Table 2.45. TCAD Device Model Parameters.

| Instance parameters      | Description  | Units            | Default | Device Type |
|--------------------------|--|------------------|---------|-------------|
| <i>All Levels</i>        |  |                  |         |             |
| function                 | functional form of doping region.<br>Options are uniform, gaussian, and step.                      |                  | 1D,2D   | uniform     |
| type                     | Ntype or Ptype   |                  | 1D,2D   | ntype       |
| nmax                     | Maximum value of impurity concentration.   | cm <sup>-3</sup> | 1D,2D   | 1.0e15      |
| nmin                     | Minimum value of impurity concentration.   | cm <sup>-3</sup> | 1D,2D   | 1.0e15      |
| xloc                     | Peak location  | cm               | 1D,2D   | 0.0         |
| xwidth                   | Distance from nmax to nmin, if applicable. This is only applicable for the function=gaussian case. |                  | 1D,2D   | 1.0e-3      |
| flatx                    | This parameter determines if we're doing a half gaussian or a full gaussian. See table 2.47        | -                | 1D,2D   | 0           |
| <i>Level 2 (2D) only</i> |  |                  |         |             |
| yloc                     | Same as xloc, but for the y-direction.   | cm               | 2D      | 0.0         |
| ywidth                   | Same as xwidth, but for the y-direction.   | cm               | 2D      | 1.0e-3      |
| flaty                    | Same as flatx, but for the y-direction.  | -                | 2D      | 0           |

Table 2.46: PDE Device Doping Region Parameters. These correspond to the region instance parameter.

| flatx or flaty value | Description  | 1D Cross Section  |
|----------------------|--|---|
| 0                    | Gaussian on both sides of the peak (xloc) location.              |  |
| +1                   | Gaussian if x>xloc, flat (constant at the peak value) if x<xloc. |  |

| flatx or flaty value | Description  | 1D Cross Section  |
|----------------------|--|---|
| -1                   | Gaussian if $x < x_{loc}$ , flat (constant at the peak value) if $x > x_{loc}$ . |  |

Table 2.47: Description of the flatx, flaty doping parameters

| Electrode parameters     | Description  | Units | Default   |
|--------------------------|--|-------|-----------|
| <i>Level 2 (2D) only</i> |  |       |           |
| name                     | Electrode name   | -     | anode     |
| bc                       | Carrier Density Boundary condition type (dirichlet or neumann) | -     | dirichlet |
| start                    | Starting location  | cm    | 0.0       |
| end                      | Ending location  | cm    | 0.0       |
| side                     | Side specification (top, bottom, left or right)                | -     | top       |
| material                 | Contact material   |       | neutral   |
| oxidebndryflag           | Oxide layer boolean  | -     | false (0) |
| oxthick                  | Oxide thickness  | cm    | 0.0       |
| oxcharge                 | Oxide charge   | C     | 0.0       |

Table 2.48: PDE Device Electrode Parameters.

## Physical Models

This section contains information about physical models used in **Xyce** for TCAD devices. This includes various mobility models, expressions for calculating the effective mass for electrons and holes, an expression for intrinsic carrier concentration as a function of temperature, expressions which describe contacts to metal as well as contacts to metal-oxide-semiconductor devices.

### Material Models and Parameters

This section describes some of the basic material properties that are available in **Xyce**. Described here are the models for effective mass, intrinsic carrier concentration, and the bandgap. This information is needed for the more complex models described in the mobility section (section 2.3) and the boundary condition section (section 2.3).

### Effective Mass

**Xyce** includes functions which return the effective mass of electrons and holes for a number of semiconductor materials.

#### Electron Effective Mass

The electron effective mass is calculated as

$$m_{de} = (m_l^* m_t^{*2})^{1/3} \quad (2.4)$$

where  $m_l$  and  $m_t$  are the effective masses along the longitudinal and transverse directions of the ellipsoidal energy surface.

#### Hole Effective Mass

The hole effective mass is calculated as

$$m_{dh} = (m_{lh}^{*3/2} + m_{hh}^{*3/2})^{2/3} \quad (2.5)$$

where  $m_{lh}$  and  $m_{hh}$  are the "light" and "heavy" hole masses, respectively.

### Intrinsic Carrier Concentration

The intrinsic carrier concentration in a semiconductor is obtained from the "np" product

$$np = n_i^2 = N_C N_V \exp(-E_g/kT) \tag{2.6}$$

or

$$n_i = \sqrt{N_C N_V} e^{-E_g/2kT} \tag{2.7}$$

The expression used in **Xyce** to calculate the intrinsic carrier concentration comes from this and is given by

$$n_i = 4.9 \times 10^{15} \left( \frac{m_{de} m_{dh}}{m_0^2} \right)^{3/4} M_c^{1/2} T^{3/2} e^{-E_g/2kT} \tag{2.8}$$

where  $M_c$  is the number of equivalent minima in the conduction band for the semiconductor,  $m_{de}$  is the density-of-state effective mass for electrons,  $m_{dh}$  is the density-of-state effective mass for holes, and  $m_0$  is the free-electron mass.

| Semiconductor   | Symbol | $M_c^{1/2}$   | $n_i$ at room temperature |
|-----------------|--------|---------------|---------------------------|
| Silicon         | si     | $\sqrt{6.00}$ | $1.25 \times 10^{10}$     |
| Germanium       | ge     | 2.00          | $2.5 \times 10^{13}$      |
| Galium Arsenide | gaas   | 1.00          | $2.0 \times 10^6$         |

Table 2.49: Intrinsic Carrier Concentration Parameters

### Bandgap

The bandgap is a material and temperature-dependent quantity. The bandgap model for semiconductor materials, is based on Thurmond [26]. This model is given by:

$$E_g = E_{g0} - A * \left( \frac{T^{2.0}}{T + T_{off}} \right) \tag{2.9}$$

where  $E_g$  is the bandgap (eV) and  $T$  is the temperature (K).  $A$ ,  $E_{g0}$ , and  $T_{off}$  are all



material-dependent constants. Insulating materials, such as silicon dioxide, are assumed to have constant bandgaps, so their bandgaps are given by:

$$E_g = E_{g0} \quad (2.10)$$

where  $E_{g0}$  is a material-dependent constant. The values for the material-dependent constants used by equations 2.9 and 2.10 are given in Table 2.50.

| Material        | Symbol | $E_{g0}$ (eV) | $A$      | $T_{off}$ (K) |
|-----------------|--------|---------------|----------|---------------|
| Silicon         | si     | 1.17          | 4.73e-4  | 636.0         |
| Germanium       | ge     | 0.7437        | 4.774e-4 | 235.0         |
| Galium Arsenide | gaas   | 1.519         | 5.405e-4 | 204.0         |
| Silicon Dioxide | sio2   | 9.00          | NA       | NA            |
| Silicon Nitride | wdi    | 4.7           | NA       | NA            |
| Sapphire        | cu     | 4.7           | NA       | NA            |

Table 2.50: Bandgap constants

## Mobility Models

A number of mobility models are included in **Xyce**. The analytic, arora, and carrier-carrier scattering models are considered to be low-field mobility models. The Lombardi surface mobility model is a transverse-field dependent model which also incorporates the mobility of the bulk silicon.

### Analytic Mobility

This is a concentration- and temperature-dependent empirical mobility model, based on the work of Caughey and Thomas [27], which combines the effects of lattice scattering and ionized impurity scattering. The equation for the mobility of electrons is:

$$\mu_{0n} = \mu_{nmin} + \frac{\mu_{nmax} \left(\frac{T}{T_{ref}}\right)^{nun} - \mu_{nmin}}{1 + \left(\frac{T}{T_{ref}}\right)^{xin} (N_{total}/N_n^{ref})^{\alpha_n}} \quad (2.11)$$

and the equation for the mobility of holes is:

$$\mu_{0p} = \mu_{pmin} + \frac{\mu_{pmax} \left(\frac{T}{T_{ref}}\right)^{nup} - \mu_{pmin}}{1 + \left(\frac{T}{T_{ref}}\right)^{xip} (N_{total}/N_p^{ref})^{\alpha_p}} \quad (2.12)$$

where  $N_{total}$  is the local total impurity concentration (in  $\#/cm^3$ ),  $T_{ref}$  is a reference temperature (300.15K), and T is the temperature (in degrees K). The parameters  $N_n^{ref}$  and  $N_p^{ref}$  are reference values for the doping concentration. The analytic mobility model can be selected by using the statement "mobmodel=analytic" in the netlist.

The parameters for the analytic mobility model are given in Table 3.

| Parameter    | Silicon  | GaAs    |
|--------------|----------|---------|
| $\mu_{nmin}$ | 55.24    | 0.0     |
| $\mu_{nmax}$ | 1429.23  | 8500.0  |
| $N_n^{ref}$  | 1.072e17 | 1.69e17 |
| nun          | -2.3     | -1.0    |
| xin          | -3.8     | 0.0     |
| $\alpha_n$   | 0.73     | 0.436   |
| $\mu_{pmin}$ | 49.70    | 0.0     |
| $\mu_{pmax}$ | 479.37   | 400.0   |
| $N_p^{ref}$  | 1.606e17 | 2.75e17 |
| nup          | -2.2     | -2.1    |
| xip          | -3.7     | 0.0     |
| $\alpha_p$   | 0.70     | 0.395   |

Table 2.51: Analytic Mobility Parameters

### Arora Mobility

This mobility model is also an analytic model which depends on impurity concentration and temperature. It comes from the work of Arora, *et al.* [28] and is based on both experimental data and the modified Brooks-Herring theory of mobility. The equation for the mobility of electrons is:

$$\mu_{0n} = \mu_{n1} \left( \frac{T}{T_{ref}} \right)^{expn1} + \frac{\mu_{n2} \left( \frac{T}{T_{ref}} \right)^{expn2}}{1 + \left( \frac{N_{total}}{Cn \left( \frac{T}{T_{ref}} \right)^{expn3}} \right)^{\alpha_n}} \quad (2.13)$$

and the equation for the mobility of holes is:

$$\mu_{0p} = \mu_{p1} \left( \frac{T}{T_{ref}} \right)^{exp1} + \frac{\mu_{p2} \left( \frac{T}{T_{ref}} \right)^{exp2}}{1 + \left( \frac{N_{total}}{Cp \left( \frac{T}{T_{ref}} \right)^{exp3}} \right)^{\alpha_p}} \quad (2.14)$$

where

$$\alpha_n = A_n \left( \frac{T}{T_{ref}} \right)^{exn4} \quad (2.15)$$

and

$$\alpha_p = A_p \left( \frac{T}{T_{ref}} \right)^{exp4} \quad (2.16)$$

The Arora mobility model can be selected by including the statement "mobmodel=arora" in the netlist. The parameters for the arora mobility model are given in Table 4.

| Parameter  | Silicon | GaAs    |
|------------|---------|---------|
| $\mu_{n1}$ | 88.0    | 8.5e3   |
| $\mu_{n2}$ | 1252.0  | 0.0     |
| Cn         | 1.26e17 | 1.26e17 |
| An         | 0.88    | 0.0     |
| exn1       | -0.57   | -0.57   |
| exn2       | -2.33   | 0.0     |
| exn3       | 2.4     | 0.0     |
| exn4       | -0.146  | 0.0     |
| $\mu_{p1}$ | 54.3    | 4e2     |
| $\mu_{p2}$ | 407.0   | 0.0     |
| Cp         | 2.35e17 | 2.35e17 |
| Ap         | 0.88    | 0.0     |
| exp1       | -0.57   | 0.0     |
| exp2       | -2.23   | 0.0     |
| exp3       | 2.4     | 0.0     |
| exp4       | -0.146  | 0.0     |

Table 2.52: Arora Mobility Parameters

## Carrier-Carrier Scattering Mobility

This mobility model is based on the work of Dorkel and Leturq [29]. It incorporates carrier-carrier scattering effects, which are important when high concentrations of electrons and

holes are present in the device. This model also takes lattice scattering and ionized impurity scattering into account. One important difference between the carrier-carrier scattering mobility model and the two previous mobility models (analytic and arora models) is that the carrier-carrier scattering mobility model depends upon the actual carrier concentrations in the device. This model is important for modeling breakdown as well as various radiation effects, which often result in very high carrier densities.

The expressions for the carrier-carrier model are as follows:

$$\mu_L = \mu_{L0} \left( \frac{T}{T_{ref}} \right)^{-\alpha} \quad (2.17)$$

where  $\mu_L$  is the lattice mobility, which has to do with scattering due to acoustic phonons.

$$\mu_I = \frac{AT^{3/2}}{N} \left[ \ln \left( 1 + \frac{BT^2}{N} \right) - \frac{BT^2}{N + BT^2} \right]^{-1} \quad (2.18)$$

where  $\mu_I$  is the impurity mobility which is related to the interactions between the carriers and the ionized impurities.

$$\mu_{ccs} = \frac{2 \times 10^{17} T^{3/2}}{\sqrt{pn}} \left[ \ln \left( 1 + 8.28 \times 10^8 T^2 (pn)^{-1/3} \right) \right]^{-1} \quad (2.19)$$

where  $\mu_{ccs}$  is the carrier-carrier scattering mobility, which is very important when both types of carriers are at high concentration.

$$X = \sqrt{\frac{6\mu_L(\mu_I + \mu_{ccs})}{\mu_I\mu_{ccs}}} \quad (2.20)$$

is an intermediate term and

$$\mu = \mu_L \left[ \frac{1.025}{1 + (X/1.68)^{1.43}} - 0.025 \right] \quad (2.21)$$

is the carrier mobility. The carrier-carrier scattering mobility can be selected by including the statement "mobmodel=carr" in the netlist. The parameters for the carrier-carrier mobility model are given in Table 5.

| Parameter | Carrier | Silicon | GaAs    |
|-----------|---------|---------|---------|
| Al        | $e^-$   | 1430.0  | 8.50e3  |
| Bl        | $e^-$   | -2.2    | 0.0     |
| Ai        | $e^-$   | 4.61e17 | 4.61e17 |
| Bi        | $e^-$   | 1.52e15 | 1.52e15 |
| Al        | $h^+$   | 495.0   | 4.0e2   |
| Bl        | $h^+$   | -2.2    | 0.0     |
| Ai        | $h^+$   | 1.00e17 | 1.00e17 |
| Bi        | $h^+$   | 6.25e14 | 6.25e14 |

Table 2.53: Carrier-Carrier Mobility Parameters

### Lombardi Surface Mobility Model

This mobility model combines expressions for mobility at the semiconductor-oxide interface and in bulk silicon. It is based on the work of Lombardi *et al.* [30]. The overall mobility is found using Mathiessen’s rule:

$$\frac{1}{\mu} = \frac{1}{\mu_{ac}} + \frac{1}{\mu_b} + \frac{1}{\mu_{sr}} \tag{2.22}$$

where  $\mu_{ac}$  is the carrier mobility due to scattering with surface acoustic phonons,  $\mu_b$  is the carrier mobility in bulk silicon, and  $\mu_{sr}$  is the carrier mobility limited by surface roughness scattering.

The Lombardi model is a more physics-based surface mobility model. It is a semi-empirical model for carrier mobility, and the expressions for the individual scattering mechanisms were extracted from experimental data taken in appropriate experimental conditions.

The expressions used in this model are given below:

$$\mu_{ac,n} = \frac{bn}{E_{\perp}} + \frac{cnN^{exn4}}{T(E_{\perp})^{1/3}} \tag{2.23}$$

is the expression for electron mobility for acoustic phonon scattering,

$$\mu_{ac,p} = \frac{bp}{E_{\perp}} + \frac{cpN^{exp4}}{T(E_{\perp})^{1/3}} \quad (2.24)$$

is the expression for hole mobility for acoustic phonon scattering,

$$\mu_{b,n} = \mu_{n0} + \frac{\mu_{max,n} - \mu_{n0}}{1 + (N/crn)^{exn1}} - \frac{\mu_{n1}}{1 + (c sn/N)^{exn2}} \quad (2.25)$$

is the expression for bulk mobility for electrons, where

$$\mu_{max,n} = \mu_{n2} \left( \frac{T}{T_{ref}} \right)^{-exn3} \quad (2.26)$$

and

$$\mu_{b,p} = \mu_{p0} \exp(-pc/N) + \frac{\mu_{max,p}}{1 + (N/crp)^{exp1}} - \frac{\mu_{p1}}{1 + (csp/N)^{exp2}} \quad (2.27)$$

is the expression for bulk mobility for holes, where

$$\mu_{max,p} = \mu_{p2} \left( \frac{T}{T_{ref}} \right)^{-exp3} \quad (2.28)$$

The expression for electrons for surface roughness scattering is

$$\mu_{sr,n} = \left( \frac{dn}{E_{\perp}^{exp8}} \right) \quad (2.29)$$

and the expression for holes for surface roughness scattering is

$$\mu_{sr,p} = \left( \frac{dp}{E_{\perp}^{exp8}} \right) \quad (2.30)$$

The parameters for the lombardi surface mobility model are given in Table 6.

| Parameter  | Silicon | GaAs    |
|------------|---------|---------|
| $\mu_{n0}$ | 52.2    | 0.0     |
| $\mu_{n1}$ | 43.4    | 0.0     |
| $\mu_{n2}$ | 1417.0  | 1e6     |
| crn        | 9.68e16 | 9.68e16 |
| csn        | 3.43e20 | 0.0     |
| bn         | 4.75e7  | 1e10    |
| cn         | 1.74e5  | 0.0     |
| dn         | 5.82e14 | 1e6     |
| exn1       | 0.680   | 0.0     |
| exn2       | 2.0     | 0.0     |
| exn3       | 2.5     | 0.0     |
| exn4       | 0.125   | 0.0     |
| exn8       | 2.0     | 0.0     |
| $\mu_{p0}$ | 44.9    | 0.0     |
| $\mu_{p1}$ | 29.0    | 0.0     |
| $\mu_{p2}$ | 470.5   | 1.0     |
| crp        | 2.23e17 | 2.23e17 |
| csp        | 6.1e20  | 0.0     |
| bp         | 9.93e6  | 1e10    |
| cp         | 8.84e5  | 0.0     |
| dp         | 2.05e14 | 1e6     |
| exp1       | 0.719   | 0.0     |
| exp2       | 2.0     | 0.0     |
| exp3       | 2.2     | 0.0     |
| exp4       | 0.0317  | 0.0     |
| exp8       | 2.0     | 0.0     |
| pc         | 9.23e16 | 0.0     |

Table 2.54: Lombardi Surface Mobility Parameters



## Edge Mobilities

Mobility values are calculated along the edge connecting two nodes. In the case of the analytic, arora, and surface mobility models, the edge mobilities are calculated by taking the average of the mobilities at the two nodes. Then, the mobility along the edge connecting nodes 1 and 2 is:

$$\mu_{edge} = (\mu[1] + \mu[2])/2.0 \quad (2.31)$$

In the case of the carrier-carrier scattering mobility, the edge mobilities were calculated differently. The electron and hole concentrations were first calculated at the midpoint of the edge using a "product" average and then these values of "n" and "p" were used in the function to calculate the mobility at the midpoint of the edge. For example, if n[1] and n[2] are the electron concentrations at nodes 1 and 2, the electron concentration along the edge is given by:

$$n_{edge} = \sqrt{n[1] * n[2]} \quad (2.32)$$

Subsequently, the mobility at the midpoint of an edge is found by using the values of electron and hole concentration at the midpoint of the edge when calling the function which returns the mobility, calcMob().

$$\mu_{n,edge}^{carrier} = f(n_{edge}) \quad (2.33)$$

This method makes more sense, especially when the electron and hole concentrations vary by several orders of magnitude. Then it approximates taking the average of the logarithms.

## Boundary Conditions for Electrode Contacts

This section describes various boundary conditions that need to be applied to the semiconductor boundary. **Xyce** is predominantly an analog circuit simulator, and the TCAD (PDE-based) device modeling that has been implemented in **Xyce** takes external circuit information as input. This input consists of voltages and currents which are applied as boundary conditions to the semiconductor domain.

The physical connection from the circuit to the device generally includes a variety of materials, including metals and oxides. Electrical differences between the semiconductor and

the contact material can result in a potential barrier that must be included in the imposed voltage boundary condition.

There are three general types of contacts between the circuit and the TCAD device which are currently handled by **Xyce**. The first is the "neutral" contact, in which it is simply assumed that the electrode material does not impose any additional potential barrier to that of the Fermi level differences in the semiconductor. The second is the Schottky contact, in which the electrode is a specified metal, and a potential barrier is imposed to account for the workfunction difference between the metal and the semiconductor. The last type of contact is the metal-oxide-semiconductor contact, in which the workfunction difference, and the voltage drop across the oxide must be accounted for.

### Neutral Contacts

A neutral contact refers to the case in which the contact is made to the semiconductor itself, and barrier heights due to material differences are not considered. This is the simplest type of contact in **Xyce**, and problems which use this type of contact are generally easier to solve, compared with other types of contacts. In this case, the boundary is given by

$$V_{bc} = V_{ckt} + V_{bi} \quad (2.34)$$

where  $V_{ckt}$  is the potential applied by the circuit and  $V_{bi}$  is the "built-in" potential of the semiconductor. For a p-type substrate, the built-in potential is given by

$$V_{bi} = -\frac{kT}{q} \ln\left(\frac{N_A}{n_i}\right) \quad (2.35)$$

and for an n-type substrate, the built-in potential is given by

$$V_{bi} = \frac{kT}{q} \ln\left(\frac{N_D}{n_i}\right) \quad (2.36)$$

$V_{bi}$  represents the extent of the energy band bending due to the doping of a device. While most of the dramatic changes will happen away from the contact, near junctions, it is still incorporated into the voltage boundary condition to maintain a flat potential near the contacts. Figure 2.2 shows the energy band variation across a PN junction, and the corresponding electrostatic potential. This variation is due to the internal physics of the device,

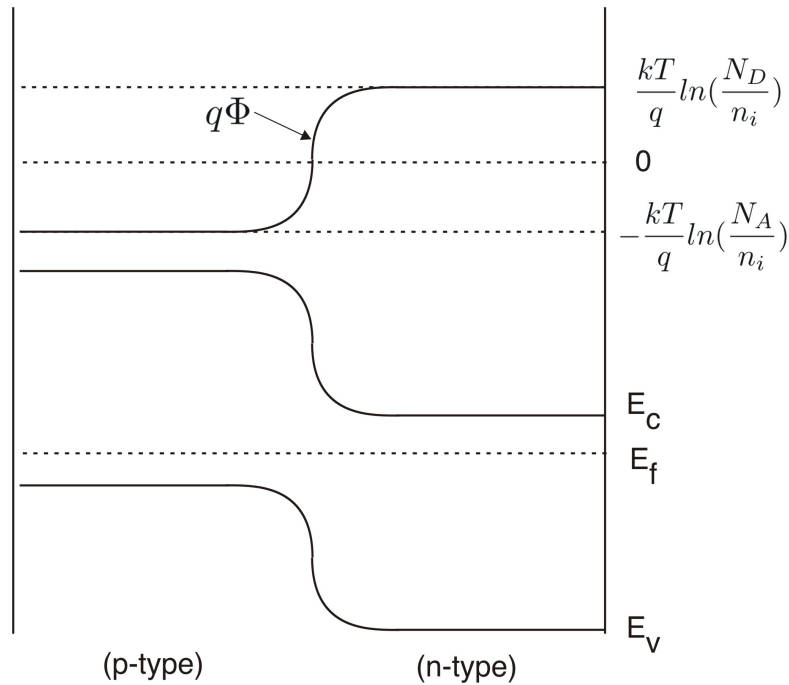

**Figure 2.2.** Neutral Contacts.

and needs to be there even in the event of zero applied voltage. This is partially enforced by the solution to Poisson's equation, and also by the application of equation 2.34.

### Schottky Contacts

In the case of a metal-semiconductor contact, it is necessary to add the workfunction difference,  $\Phi_{ms}$ , to the potential in the semiconductor [31].  $\Phi_m$  is a constant for a given metal, and  $\Phi_s$  is a function of the doping in the semiconductor. The workfunction potential,  $\Phi$ , when multiplied by  $q$ , is the difference between the Fermi level and vacuum in the material. In essence, the workfunction difference represents the distance between the Fermi level in the metal and the Fermi level in the semiconductor when considering the individual band structures.

In the case of an n-type semiconductor, the semiconductor workfunction can be represented as

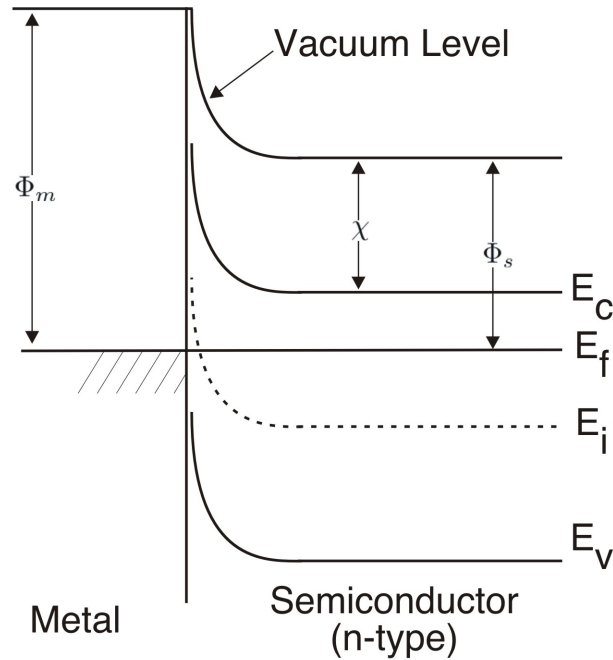

**Figure 2.3.** Schottky Contact, N-type.

$$\Phi_s = \chi + (E_C - E_{FS})/q \tag{2.37}$$

where  $\chi$  is the electron affinity in the semiconductor and  $q\chi$  is the distance between the conduction band and vacuum in the semiconductor.  $E_C$  is the conduction band energy and  $E_{FS}$  is the Fermi level of the semiconductor. Rewriting this expression in terms of the doping concentration, it becomes

$$\Phi_s = \chi + E_g/2 - V_t \ln\left(\frac{N_d}{n_i}\right) \tag{2.38}$$

In the case of a p-type semiconductor, the semiconductor workfunction can be represented as

$$\Phi_s = \chi + E_g/2 + (E_i - E_{FS})/q \tag{2.39}$$

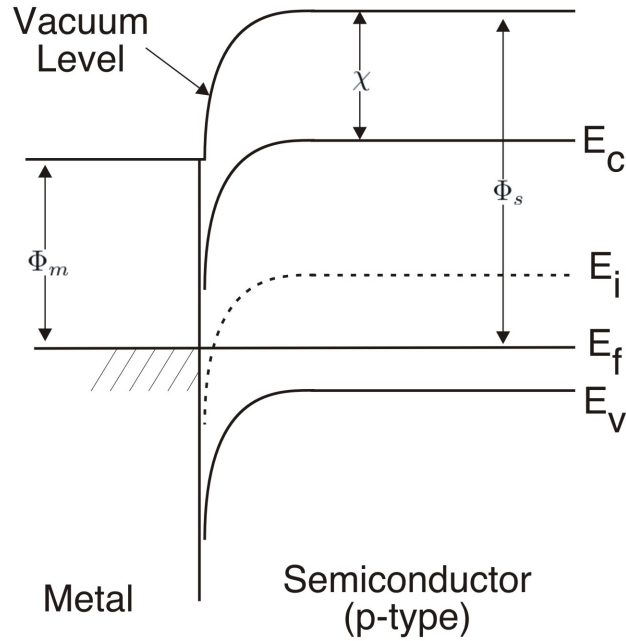

**Figure 2.4.** Schottky Contact, P-type.

where  $E_i$  is the intrinsic value of the Fermi level, and can be approximated as the halfway point between the conduction band ( $E_C$ ) and the valance band ( $E_V$ ). Rewriting this expression in terms of the doping concentration

$$\Phi_s = \chi + E_g/2 + V_t \ln\left(\frac{N_a}{n_i}\right) \quad (2.40)$$

For the TCAD devices in **Xyce**, for a node at a metal-semiconductor contact, the quantity  $\Phi_m - \Phi_s$  is added to the potential at the node to account for the metal-semiconductor barrier. The current values of metal workfunctions used in **Xyce** are given in Table 2.55. The values for electron affinity are given in Table 2.56. The boundary condition for a metal electrode in **Xyce** is given by

$$V_{bc} = V_{ckt} + V_{bi} + \Phi_{ms} \quad (2.41)$$

where  $V_{ckt}$  is the potential applied by the circuit to the electrode and  $V_{bi}$  is the "built-in"

potential of the semiconductor, a function of the semiconductor doping.

| <b>Metal</b>          | <b>Symbol</b> | <b>Workfunction, <math>\Phi_m</math> (Volts)</b> |
|-----------------------|---------------|--|
| aluminum              | al            | 4.10   |
| p+-polysilicon        | ppoly         | 5.25   |
| n+-polysilicon        | npoly         | 4.17   |
| molybdenum            | mo            | 4.53   |
| tungsten              | w             | 4.63   |
| molybdenum disilicide | modi          | 4.80   |
| tungsten disilicide   | wdi           | 4.80   |
| copper                | cu            | 4.25   |
| platinum              | pt            | 5.30   |
| gold                  | au            | 4.80   |

Table 2.55: Material workfunction values

| <b>Semiconductor</b> | <b>Symbol</b> | <b>Electron Affinity, <math>\chi</math> (Volts)</b> |
|----------------------|---------------|---|
| Silicon              | si            | 4.17  |
| Germanium            | ge            | 4.00  |
| Galium Arsenide      | gaas          | 4.07  |
| Silicon Dioxide      | sio2          | 0.97  |
| Nitride              | nitride       | 0.97  |
| Sapphire             | sapphire      | 0.97  |

Table 2.56: Electron affinities

## Metal-Oxide-Semiconductor Contacts

To date in **Xyce**, only semiconductor material is included in the PDE solution domain. Metals and oxide materials are currently only included through boundary conditions. This is an adequate approach for a lot of problems. For some problems (such as modeling of low-dose radiation effects) modeling the oxide in more detail, as a PDE, will become necessary. However, since oxides are usually very thin, compared with the semiconductor domain, meshing both materials as part of the same simulation is difficult. Therefore, incorporating the effects of a gate oxide as part of the gate boundary condition is a reasonable approach.

In the case of a contact to a metal-oxide-semiconductor structure, the separation of the Fermi energies in the metal and the semiconductor at equilibrium is due to two effects: the workfunction difference between the metal and the semiconductor, and the effective interface charge. These two effects cause the bands to bend at the surface in equilibrium. The flatband voltage is the sum of these two terms [31]:

$$V_{FB} = \Phi_{ms} - \frac{Q_i}{C_i} \quad (2.42)$$

where  $\Phi_{ms}$  is the metal-semiconductor workfunction difference,  $Q_i$  is the value of interface charge (in  $C/cm^2$ ), and  $C_i$  is the oxide capacitance per unit area, which is given by

$$C_i = \frac{\epsilon_{ox}\epsilon_0}{x_o} \quad (2.43)$$

The voltage  $V_{FB}$  is the amount of bias which, when applied to the gate, causes the electron energy bands to be flat. This is the potential that is added to a boundary node in **Xyce** to account for a metal-oxide-semiconductor barrier. The overall boundary condition for a contact to a metal-oxide-semiconductor structure is given by

$$V_{bc} = V_{ckt} + V_{bi} + \Phi_{ms} - Q_i/C_i \quad (2.44)$$

where  $V_{ckt}$  is the potential applied by the circuit and  $V_{bi}$  is the "built-in" potential of the semiconductor.



## NMOS Device

The default NMOS device currently used in **Xyce** has a substrate doping concentration of  $1.0 \times 10^{16}/cm^3$  and an oxide thickness of  $1.0 \times 10^{-6}cm$ . Since the ideal threshold voltage  $V_T$  is given by

$$V_T = 2\phi_F + \frac{\epsilon_s}{\epsilon_{ox}} x_o \sqrt{\frac{2qN_A\phi_F}{\epsilon_s\epsilon_0}} \quad (2.45)$$

$V_T$  is equal to 0.892 V. for this device. Note that

$$\phi_F = \frac{1}{q}[E_i(bulk) - E_F] = \frac{kT}{q} \ln\left(\frac{N_A}{n_i}\right) \quad (2.46)$$

for a p-type semiconductor substrate and

$$\phi_F = -\frac{kT}{q} \ln\left(\frac{N_D}{n_i}\right) \quad (2.47)$$

for an n-type substrate.



# 3. Command Line Arguments

---

**Xyce** supports a handful of command line arguments which must be given *before* the netlist filename. While most of these are intended for general use, others simply give access to new features that, while supported, are not enabled by default. These options are designated as *trial* options. The general usage is as follows:

```
runxyce [arguments] <netlist filename>
```

Table 3.1 gives a complete lists of command line options.

| Argument | Description                                       | Usage  | Default                              |
|----------|---|--|--------------------------------------|
| -h       | Help option. Prints usage and exits.              | -h   | -                                    |
| -v       | Prints the version banner and exits.              | -v   | -                                    |
| -delim   | Set the output file field delimiter.              | -delim<br><TAB COMMA string>                 | -                                    |
| -o       | Place the results into specified file.            | -o <file>                                    | -                                    |
| -l       | Place the log output into specified file.         | -l <file>                                    | -                                    |
| -r       | Output a binary rawfile.                          | -r <file>                                    | -                                    |
| -a       | Use with -r to output a readable (ascii) rawfile. | -r <file> -a                                 | -                                    |
| -nox     | Use the NOX nonlinear solver.                     | -nox <ON OFF>                                | on                                   |
| -info    | Output information on parameters.                 | -info<br>[device prefix]<br>[level] [ON OFF] | -                                    |
| -linsolv | Set the linear solver.                            | -linsolv <KLU <br>SUPERLU AZTECOO>           | klu(serial) and<br>aztecoo(parallel) |

| Argument       | Description  | Usage  | Default |
|----------------|--|--|---------|
| -param         | Print a terse summary of model and/or device parameters. | -param<br>[<device prefix><br>[<level><br>[<INST MOD>] ] ] | -       |
| -syntax        | Check netlist syntax and exit.                           | -syntax  | -       |
| -norun         | Netlist syntax and topology and exit.                    | -norun   | -       |
| -maxord        | Maximum time integration order.                          | -maxord <1..5>   | -       |
| -gui           | GUI file output.   | -gui   | -       |
| -jacobian_test | Jacobian matrix diagnostic.                              | -jacobian_test   | -       |

Table 3.1: List of **Xyce** command line arguments.

# 4. Runtime Environment

---

## Running **Xyce** in Serial

Use the `runxyce` script to run serial versions of **Xyce**. This script sets the environment variables, `LD_LIBRARY_PATH` or `DYLD_LIBRARY_PATH`, and starts Xyce. No additional runtime configuration is necessary.

## Running **Xyce** in Parallel

Open MPI must be installed on the host machine. It may be download from

<http://www.open-mpi.org/>. Consult the documentation for help with installation.

Use the `xmpirun` to run parallel versions of **Xyce**. This script sets the environment variables, `LD_LIBRARY_PATH` or `DYLD_LIBRARY_PATH`, and starts Xyce using the `mpiexec` wrappers.

## Running **Xyce** on Sandia HPC Platforms

In addition to the steps above for running **Xyce**, there is a **xyce** module available that sets the runtime environment (Open MPI, Intel MKL, Intel Compilers, etc.). To load the module, use the command:

```
module load xyce
```

Consult the system documentation for help with submitting jobs on these platforms.

<https://computing.sandia.gov/>



# 5. Setting Convergence Parameters for **Xyce**

---

Because the solution algorithms and methods within **Xyce** are different than those used by other circuit simulation tools (e.g., ChileSPICE), the overall convergence behavior is sometimes different as are the parameters which control this behavior.

With **Xyce** Release 4.0 several of the default transient parameters have been changed to improve overall performance and help make **Xyce** more competitive with other codes. While these defaults have been extensively tested to ensure acceptable accuracy, it is possible that some accuracy has been lost in order to provide improved performance. While this is likely negligible, accuracy can be improved by tightening the error tolerances and/or changing the time-integration order from their default values. As this is typically an issue for transient simulations, the following discussion applies to that context only. For a complete list of available solution control options, go to 2.1 in chapter 2.

## Adjusting Transient Analysis Error Tolerances

As of Release 4.0, the default for **Xyce** is to use a variable order Backward Differentiation Formula (BDF 1-5) time integration method (also known as a 1-5 step Gear method) for performing transient analysis [32]. This method starts out with Backward Euler on the first few steps and then ramps up to as high an order as will maintain stability and which takes the largest time steps. The maximum order it can attain is five and this can be reduced with the `MAXORD` option. It is also possible to set a minimum order which the integrator should maintain with the option `MINORD`. When `MINORD` is set, the integrator will move upward in order from Backward Euler as quickly as possible to achieve `MINORD` and then it will adjust the order between `MINORD` and `MAXORD` to maintain stability and take large steps. See table 2.2 for details.

**Xyce** also supports variable order trapezoid integration through the `TIMEINT` option `METHOD=7`. Trapezoid time-stepping is second order accurate and does not have any numerical dissipation in its local truncation error. Variable order trapezoid integration dynamically uses

Backward euler (BE) and trapezoid rule. When `ERROPTION=1` is set with `METHOD=7`, trapezoidal rule is used almost exclusively (BE only used at breakpoints). See table 2.2 for details.

## Setting RELTOL and ABSTOL

In **Xyce**, there is currently `RELTOL` and `ABSTOL` settings for both the time integration package and the nonlinear solver package. Some general guidelines for settings parameters are [32]:

- Use the *same* `RELTOL` and `ABSTOL` values for both the `TIMEINT` and the `NONLIN-TRAN .OPTIONS` statements.
- For a conservative approach (i.e., safe), set `RELTOL=1.0E-(m+1)` where `m` is the desired number of significant digits of accuracy.
- Set `ABSTOL` to the smallest value at which the solution components (either voltage or current) are essentially insignificant.
- *Note* that the above suggests that `ABSTOL < RELTOL`.

The current defaults for these parameters are `ABSTOL=1.0E-6` and `RELTOL = 1.0E-2`. For a complete list of the time integration parameters, see chapter 2.1.

## Adjusting Nonlinear Solver Parameters (in transient mode)

In **Xyce**, the nonlinear solver options for transient analysis are set using the `.OPTIONS NONLIN-TRAN` line in a netlist. This subsection gives some guidelines for setting this parameters.

- For guidelines on setting `RELTOL` and `ABSTOL`, see above.
- `RHSTOL` – This is the maximum residual error for each nonlinear solution. **Xyce** uses this as a “safety” check on nonlinear convergence. Typically, `1.0E-2` (the default) works well.
- `DELTA XTOL` – This is the weighted update norm tolerance and is the primary check for nonlinear convergence. Since it is weighted (i.e., normalized using `RELTOL` and `ABSTOL`), a value of `1.0` would give it the same accuracy as the time integrator. For robustness, the default is `0.33` but sometimes a value of `0.1` may help prevent “time-step too small” errors. A value of `0.01` is considered quite small.



- **MAXSTEP** – This is the maximum number of Newton (nonlinear) steps for each nonlinear solve. In transient analysis, the default is 20 but can be increased to help prevent “time-step too small” errors. This is roughly equivalent to ITL4 in ChileSPICE.



# 6. Quick Reference for Orcad PSpice Users

---

This chapter describes many of the differences between **Xyce** and Orcad PSpice with an eye towards providing the ability for those familiar with using PSpice to begin using **Xyce** quickly. **Xyce** is still under development, so this section will change as new capabilities are added to **Xyce**. Also, note that there is also a quick reference chapter for ChileSPICE users 7, and many of the issues covered in that chapter are also applicable to PSpice.

## GUI Support

There is currently no Graphical User Interface (GUI) support for Xyce.

## Command Line Options

Command line arguments are supported in **Xyce** but they are different than those of PSPICE. For a complete reference, see chapter 3.

## Device Support

Most, but not all, devices commonly found in circuit simulation tools are supported. **Xyce** also contains enhanced versions of many semiconductor devices that simulate various environmental effects. For the complete list, please see the Analog Device Summary in Table 2.9.

## Netlist Support

To the extent that specific devices or models are supported in **Xyce**, it supports most of the standard netlist inputs as may be found in standard SPICE. However, the `.OPTIONS` command has several additional features used to expose capabilities specific to **Xyce**. In

particular, **Xyce** does not currently support the standard PSpice format `.OPTIONS` line in netlists. Instead, package specific `.OPTIONS` lines are supported according to the following format: `.OPTIONS {PKG} <<TAG=>VALUE> ...`. The **Xyce** packages which currently support `.OPTIONS` are:

| Package                            | PKG keyword |
|------------------------------------|-------------|
| Global:                            | GLOBAL      |
| Device Model:                      | DEVICE      |
| Time Integration:                  | TIMEINT     |
| Nonlinear Solver:                  | NONLIN      |
| Transient Nonlinear Solver:        | NONLIN-TRAN |
| Continuation/Bifurcation Tracking: | LOCA        |
| Linear Solver:                     | LINSOL      |
| Output:                            | OUTPUT      |
| Restart:                           | RESTART     |
| MPDE:                              | MPDEINT     |
| Harmonic Balance:                  | HBINT       |

For a complete description of the supported options, see section 2.1.

**Xyce** does not support the `.PROBE` statement. Output of Probe format files is done using the `.PRINT` netlist statement. See chapter 2 for syntax.

**Xyce** does not support PSPICE style abbreviations in the `.PRINT` statement. For example, to print out the value of the voltage at node A in a transient simulation you must request `.PRINT TRAN V(A)`, not `.PRINT TRAN A`.

## Converting PSpice ABM Models for Use in Xyce

As of the **Xyce** Version 3.0 release, **Xyce** is almost fully compatible with PSpice with respect to analog behavioral models. This includes the E, F, G, and H device types. A notable exception to this compatibility is in the use of lead and device currents in expressions. These are limited to expressions in the `.PRINT` statement.

## Usage of .STEP Analysis

The implementation of .STEP in **Xyce** is not yet fully compatible with that of PSpice. This will be corrected in subsequent releases of **Xyce**.

### Sweep Type

PSpice supports four different sweep types: linear, octave, decade, and list. All of these are supported in Xyce.

### Global .PARAM Sweeps

PSpice also supports sweeps over variables specified in .PARAM lines. This is not supported in **Xyce**. This block of text will not work in **Xyce**:

```
VAB 2 0 5
VAC 1 0 variable
.param variable=0
.step param variable 0 5 1
.dc VAB 4 5 1
```

.PARAM with a .global\_param, and removal of the param keyword from the .STEP line:

```
.global_param variable=0
VAB 2 0 5
VAC 1 0 variable
.step variable 0 5 1
.dc VAB 4 5 1
```

### Model Parameter Sweeps

PSpice requires extra keywords to apply a .STEP statement to a model parameter. **Xyce** handles model parameters differently, and is actually somewhat more flexible. Unfortunately, this means that the two specifications are not compatible.

A model parameter in PSpice would be handled like this:

```
R1 1 2 RMOD 1
.model RMOD RES(R=30)
.step RES RMOD(R) 30 50 5
```

The equivalent way to specify this in **Xyce** would be:

```
R1 1 2 RMOD 1
.model RMOD RES(R=30)
.step RMOD:R 30 50 5
```

Note that **Xyce** does not require the RES keyword on the .STEP line. In PSpice, this keyword is needed to specify what type of model is being used. **Xyce** actually has more flexibility than PSpice in this regard - any model or instance variable can be set, on the .STEP line, using the same syntax.

**Example:**            .step D101:IS 1.0e-3 5.0e-3 1.0e-3

In this example, D101 is the name of a model, or instance, and IS is the name of the parameter within that model or instance.

## Other differences

Some other differences between **Xyce** and PSpice are described in table 6.1.

| Issue   | Comment   |
|---|---|
| .VECTOR, .WATCH, and .PLOT output control analysis are not supported. | <b>Xyce</b> currently does not support these commands. If enough users request them, they may be supported in the future.   |
| .AC, .FOUR, .NOISE, .SENS and .TF analysis types are not supported.   | <b>Xyce</b> fully supports .DC and .TRAN analysis. .OP is partially supported. .AC and .SENS are planned features. Other analyses, such as .NOISE may be supported in the future, if enough users request them. |
| .MC and .WCASE statistical analyses are not supported.                | <b>Xyce</b> currently does not support these commands. If enough users request them, they may be supported in the future.   |

| Issue  | Comment   |
|--|---|
| .DISTRIBUTION, which defines a user distribution for tolerances, is not supported. | <b>Xyce</b> does not support this command. This command goes along with .MC and .WCASE statistical analyses, which are also not supported.  |
| .LOADBIAS, .SAVEBIAS, and .NODESET initial condition commands are not supported.   | <b>Xyce</b> does not support these commands.  |
| .ALIASES, .ENDALIASES, are not supported.  | <b>Xyce</b> does not support these commands.  |
| .STIMULUS is not supported.  | <b>Xyce</b> does not support this command.  |
| .TEXT is not supported.  | <b>Xyce</b> does not support this command.  |
| .SAVE does not work  | <b>Xyce</b> does not support this. Use .PRINT instead.  |
| .PROBE does not work   | <b>Xyce</b> does not support this. Use the FORMAT=PROBE option of .PRINT instead. See section 2 for syntax.   |
| .OP is incomplete  | An .OP netlist will run in <b>Xyce</b> , but will not produce the extra output normally associated with the .OP statement.  |
| .SENS is only supported in the development builds of <b>Xyce</b>                   | This is currently a research issue in <b>Xyce</b> , and will be available in later release versions of <b>Xyce</b> .  |
| Pulsed source rise time of zero  | A requested pulsed source rise/fall time of zero really is zero in <b>Xyce</b> . In other simulators, requesting a zero rise/fall time causes them to use the printing interval found on the tran line. |
| Mutual Inductor Model  | Not the same as PSpice. This is a Sandia developed model.   |
| .PRINT line shorthand  | Output variables have to be specified as a V(node) or I(source). Listing the node alone will not work.  |
| BSIM3 level  | In <b>Xyce</b> the BSIM3 level=9. In PSpice the BSIM3 is level=8.   |
| Node names vs. device names  | Currently, circuit nodes and devices <i>MUST</i> have different names in <b>Xyce</b> . Some simulators can handle a device and a node with the same name, but <b>Xyce</b> cannot.                       |
| Interactive mode   | <b>Xyce</b> does not have an interactive mode.  |

| Issue  | Comment  |
|--|--|
| Time integrator default tolerances           | <b>Xyce</b> has much tighter default solver tolerances than some other simulators (e.g., PSpice), and thus often takes smaller time steps. As a result, it will often take a greater number of total time steps for a given time interval. To have <b>Xyce</b> take time steps comparable to those of PSpice, set the RELTOL and ABSTOL time integrator options to larger values (e.g., RELTOL=1.0E-2, ABSTOL=1.0E-6).   |
| .OPTIONS statements                          | <b>Xyce</b> does not support PSpice style .OPTION statements. In <b>Xyce</b> , the various packages all (potentially) have their own separate .OPTIONS line in the netlist. For a complete description, see section 2.1.   |
| DTMAX  | <b>Xyce</b> does support a maximum time step-size control on the .tran line, but we discourage its use. The time integration algorithms within <b>Xyce</b> use adaptive time-stepping methods that adjust the time-step size according to the activity in the analysis. If the simulator is not providing enough accuracy, the RELTOL and ABSTOL parameters should be decreased for both the time integration package (.OPTIONS TIMEINT) and the transient nonlinear solver package (.OPTIONS NONLIN-TRAN). We have found that in most cases specifying the same maximum timestep that PSpice requires for convergence actually slows Xyce down by preventing it from taking larger timesteps when the behavior warrants.                                  |
| Nonlinear Dependent Source (B source) syntax | <b>Xyce</b> requires curly braces around all ABM expressions, where PSpice does not. See section 2.  |
| .TRAN "UIC" keyword                          | PSpice requires the use of a keyword UIC on the .TRAN line in order to use initial conditions via IC keywords on instance lines. Doing so also tells PSpice not to perform an operating point calculation. In <b>Xyce</b> , UIC is ignored and produces a warning message. <b>Xyce</b> always uses initial conditions specified with IC keywords, and the case of inductors and capacitors automatically inserts a fictitious voltage source around the device that guarantees the correct potential drop across the device during the operating point. If the user desires that Xyce not perform an operating point calculation, but rather use an initial condition for a transient run of all zero voltages, then the user should specify NOOP instead. |
| Temperature specification                    | Device temperatures in <b>Xyce</b> are specified through the .OPTIONS DEVICE line. PSpice allows a .TEMP line that is not recognized (and is ignored) by <b>Xyce</b> .   |

Table 6.1: Incompatibilities with PSpice.



# 7. Quick Reference for ChileSPICE Users

---

A large number of potential **Xyce** users have experience using Sandia's ChileSPICE circuit simulator, which is a shared-memory parallel code based on Berkely's SPICE version 3f5. Table 7.1 lists some of the differences between ChileSPICE and **Xyce**. Many of these are the same as the differences between PSpice and **Xyce**, which were listed in table 6.1.

| Issue                              | Comment  |
|------------------------------------|--|
| .SAVE does not work                | <b>Xyce</b> does not support this. Use .PRINT instead.   |
| .PROBE does not work               | <b>Xyce</b> does not support this. Use the FORMAT=PROBE option of .PRINT instead. See section 2 for syntax.  |
| .OP is incomplete                  | An .OP netlist will run in <b>Xyce</b> , but will not produce the extra output normally associated with the .OP statement.   |
| Pulsed source rise time of zero    | A requested pulsed source rise/fall time of zero really is zero in <b>Xyce</b> . In other simulators, requesting a zero rise/fall time causes them to use the printing interval found on the tran line.  |
| Mutual Inductor Model              | Not the same as PSpice. This is a Sandia developed model.  |
| .PRINT line shorthand              | Output variables have to be specified as a V(node) or I(source). Listing the node alone will not work.   |
| BSIM3 level                        | In <b>Xyce</b> the BSIM3 level=9. In ChileSPICE the BSIM3 is level=8.  |
| Node names vs. device names        | Currently, circuit nodes and devices <i>MUST</i> have different names in <b>Xyce</b> . Some simulators can handle a device and a node with the same name, but <b>Xyce</b> cannot.  |
| Time integrator default tolerances | <b>Xyce</b> has much tighter default solver tolerances than some other simulators (e.g., ChileSPICE), and thus often takes smaller time steps. As a result, it will often take a greater number of total time steps for a given time interval. To have <b>Xyce</b> take time steps comparable to those of ChileSPICE, set the RELTOL and ABSTOL time integrator options to larger values (e.g., RELTOL=1.0E-2, ABSTOL=1.0E-6). |

| Issue   | Comment  |
|---|--|
| ChileSPICE-specific "operating point voltage sources" | These are not currently supported within <b>Xyce</b> . The capacitor, inductor, BSIM3, and B3SOI are the only devices that currently support the "IC=" parameter, both insert the equivalent of operating-point voltage sources automatically when an initial condition is given.  |
| .OPTIONS statements                                   | <b>Xyce</b> does not support ChileSPICE style .OPTION statements. In <b>Xyce</b> , the various packages all (potentially) have their own separate .OPTIONS line in the netlist. For a complete description, see section 2.1.   |
| DTMAX   | <b>Xyce</b> does support a maximum time step-size control on the .tran line, but we discourage its use. The time integration algorithms within <b>Xyce</b> use adaptive time-stepping methods that adjust the time-step size according to the activity in the analysis. If the simulator is not providing enough accuracy, the RELTOL and ABSTOL parameters should be decreased for both the time integration package (.OPTIONS TIMEINT) and the transient nonlinear solver package (.OPTIONS NONLIN-TRAN). We have found that in most cases specifying the same maximum timestep that ChileSPICE requires for convergence actually slows Xyce down by preventing it from taking larger timesteps when the behavior warrants.                                    |
| Nonlinear Dependent Source (B source) syntax          | <b>Xyce</b> requires curly braces around all ABM expressions, where ChileSPICE does not. See section 2.  |
| .TRAN "UIC" keyword                                   | SPICE 3F5 requires the use of a keyword UIC on the .TRAN line in order to use initial conditions via IC keywords on instance lines. Doing so also tells SPICE 3F5 not to perform an operating point calculation. In <b>Xyce</b> , UIC is ignored and produces a warning message. <b>Xyce</b> always uses initial conditions specified with IC keywords, and the case of inductors and capacitors automatically inserts a fictitious voltage source around the device that guarantees the correct potential drop across the device during the operating point. If the user desires that Xyce not perform an operating point calculation, but rather use an initial condition for a transient run of all zero voltages, then the user should specify NOOP instead. |
| Temperature specification                             | Device temperatures in <b>Xyce</b> are specified through the .OPTIONS DEVICE line. ChileSPICE allows a .TEMP line that is not recognized (and is ignored) by <b>Xyce</b> .   |

| Issue                                      | Comment  |
|--|--|
| AREA parameter for radiation aware devices | The diode and BJT support a parameter on the instance line called AREA, and in both standard and radiation aware devices this is used to scale certain model parameters. In ChileSPICE this same parameter is used to scale the photocurrent. In <b>Xyce</b> it is used only to scale the model parameters, and a new model parameter DEVICEAREA is used to scale the photocurrent. This enables SPUDS data sets for real devices to be used unmodified except for the addition of the radiation-specific parameters. ChileSPICE requires that the scaled model parameters be adjusted to take into account the device area parameter. |
| .STEP syntax is not the same.              | This issue is well covered in the PSpice quick reference. See section 6.   |

Table 7.1: Incompatibilities with ChileSPICE.



# 8. Quick Reference for Microsoft Windows Users

---

**Xyce** is supported on Microsoft Windows. However, the primary targets for **Xyce** are high-performance supercomputers and workstations, which are almost always running a variant of Unix. Also, 99% of **Xyce** development is done on Unix platforms. Bearing this in mind, there are occasionally issues with using a Unix application on a Windows platform. Some of these issues are described in the table below.

| Issue   | Comment  |
|---|--|
| File names need to be case-sensitive                    | <b>Xyce</b> will expect library files, which are referenced in the netlist, to have exactly the same case as the actual filename. If not, <b>Xyce</b> will be unable to find the library file.   |
| <b>Xyce</b> is unable to read proprietary file formats. | Programs such as Microsoft Word by default use file formats that <b>Xyce</b> cannot recognize. It is best not to use such programs to create netlists, unless netlists are saved as *.txt files. If you must use a Microsoft editor, it is better to use Microsoft Notepad. In general, the best solution is to use a Unix-style editor, such as Vi, Gvim, or Emacs. |

Table 8.1: Issues for Microsoft Windows.



# 9. Rawfile Format

---

The rawfile format produced by **Xyce** closely follows Spice3 conventions. Differences are noted in section 9. Details on the both the ascii and binary formats are provided here for reference.

## Ascii Format

The ascii format consists of lines or sets of lines introduced by a keyword. The `Title` and `Date` lines should be the first in the file and should occur only once, followed by the `Plotname`, `Flags`, `No. Variables`, `No. Points`, `Variables`, and `Values` lines. Note that after the `Variables` keyword there must be *numvars* declarations of outputs, and after the `Values` keyword, there must be *numpoints* lines, each consisting of *numvars* values.

## Binary Format

The binary format is similar to the ascii format, except that strings are null terminated rather than newline terminated. Binary storage of real values as double precision floats is architecture specific.

## Special Notes

- Complex data points are not used.
- `Commands` and `Options` lines are not used.
- Limited to single dimension and single plot.
- Binary header is formatted ascii.

| Line Name      | Description  |
|----------------|--|
| Title:         | An arbitrary string describing the circuit   |
| Date:          | A free-format date string  |
| Plotname:      | A string describing the analysis type  |
| Flags:         | A string describing the analysis type. <i>real</i>   |
| No. Variables: | The number of variables  |
| Variables:     | The number of points   |
| Variables:     | A newline followed by multiple lines, one for each variable, of the form [tab] <index> [tab] <name> [tab] <type> where type is either <i>current</i> or <i>voltage</i> . |
| Values:        | A newline followed by multiple lines, for each point and variable, of the form [tab] <value> with an integer index preceding each set of points.                         |

**Table 9.1.** Xyce ascii rawfile format.

| Line Name      | Description  |
|----------------|--|
| Title:         | An arbitrary string describing the circuit   |
| Date:          | A free-format date string  |
| Plotname:      | A string describing the analysis type  |
| Flags:         | A string describing the analysis type. <i>1</i>  |
| No. Variables: | The number of variables  |
| Variables:     | The number of points   |
| Variables:     | A newline followed by multiple lines, one for each variable, of the form [tab] <index> [tab] <name> [tab] <type> where type is either <i>current</i> or <i>voltage</i> . |
| Binary:        | Each real data point is stored contiguously in sizeof(double) byte blocks.   |

**Table 9.2.** Xyce binary rawfile format.



## Bibliography

- [1] Eric R. Keiter, Thomas V. Russo, Eric L. Rankin, Richard L. Schiek, Heidi K. Thornquist, Deborah A. Fixel, Todd S. Coffey, Roger P. Pawlowski, Keith R. Santarelli, and Christina E. Warrender. Xyce parallel electronic simulator: User's guide, version 5.2. Technical Report SAND2011-xxxx, Sandia National Laboratories, Albuquerque, NM, 2011.
- [2] Orcad PSpice User's Guide. Technical report, Orcad, Inc., 1998.
- [3] T. Banwell. Bipolar transistor circuit analysis using the lamber w-function. *IEEE Transactions on Circuits and Systems*, 47(11):1621–1633, November 2000.
- [4] R. S. Tuminaro, M. A. Heroux, S. A. Hutchinson, and J. N. Shadid. Official Aztec User's Guide: Version 2.1. Technical report, Sandia National Laboratories, Albuquerque, NM, December 1999.
- [5] Arthur P. Mattuck. *Introduction to Analysis*. Prentice Hall, Inc., 1999.
- [6] H. K. Gummel and H. C. Poon. An integral charge control model of bipolar transistors. *Bell Sys. Techn. J.*, May-June:827–852, 1970.
- [7] Colin McAndrew, Mark Dunn, Shahriar Moinian, and Michael Schröter. VBIC95, The Vertical Bipolar Inter-Company Model. *IEEE Journal of Solid-State Circuits*, 31(10):1476–1483, 1996.
- [8] A. S. Grove. *Physics and Technology of Semiconductor Devices*. John Wiley and Sons, Inc., 1967.
- [9] P. Antognetti and G. Massobrio. *Semiconductor Device Modeling with SPICE*. McGraw-Hill, 1988.
- [10] J.H. Huang, Z.H. Liu, M.C. Jeng, K. Hui, M. Chan, P.K. KO, and C. Hu. BSIM3 Manual. Technical report, Department of Electrical Engineering and Computer Science, University of California, Berkeley, CA 94720.

- [11] P. Su, H. Wan, S. Fung, M. Chan, A. Niknejad, and C. Hu. BSIM3SOI3.1 MOSFET MODEL Users' Manual. Technical report, Department of Electrical Engineering and Computer Science, University of California, Berkeley, CA 94720.
- [12] P. Su, H. Wan, S. Fung, M. Chan, A. Niknejad, and C. Hu. BSIM3SOI3.2 documentation. Technical report, Department of Electrical Engineering and Computer Science, University of California, Berkeley, CA 94720.
- [13] T. A. Fjeldly, T. Ytterdal, and M. Shur. *Introduction to Device Modeling and Circuit Simulation*. Wiley InterScience, 1998.
- [14] G. Gildenblat, X. Li, W.Wu, H. Wang, A. Jha, R. van Langevelde, G.D.J. Smit, A.J. Scholten, and D.B.M. Klaassen. Psp: An advanced surface-potential-based mosfet model for circuit simulation. *IEEE Transactions on Electron Devices*, 53(9):1979–1993, 2006.
- [15] M. Bucher, C. Lallement, C. Enz, F. Theodoloz, and F. Krummenacher. The EPFL/EKV MOSFET Model Equations for Simulation Technical Report: Model Version 2.6. Technical report, Electronics Laboratories, Swiss Federal Institute of Technology (EPFL), Lausanne, Switzerland, September 1997.
- [16] M. Bucher, A. Bazigos, E. Kitonaki, and F. Krummenacher. Recent advances in the ekv3 mos transistor model. In *NANOTECH 2006, Workshop on Compact Models*, May 2006.
- [17] M. Bucher, D. Diamantakos, A. Bazigos, and F. Krummenacher. Design-oriented characterization and parameter extraction methodologies for the ekv3 mosfet model. In *NANOTECH 2007 Workshop on Compact Modeling*, May 2007.
- [18] A. Vladimirescu and S. Lui. The Simulation of MOS Integrated Circuits using SPICE2. Technical Report Memorandum No. M80/7, February 1980.
- [19] H. Shichman and D. A. Hodges. Modeling and simulation of insulated-gate field-effect transistor switching circuits. *IEEE Journal of Solid-State Circuits*, SC-3:285, September 1968.
- [20] B. J. Sheu, D. L. Scharfetter, P.-K. Ko, and M.-C. Jeng. Bsim: Berkeley short-channel igfet model for mos transistors. *IEEE Journal of Solid-State Circuits*, SC-22:558–566, August 1987.
- [21] J. R. Pierret. A MOS Parameter Extraction Program for the BSIM Model. Technical Report Memorandum No. M84/99 and M84/100, November 1984.

- [22] Ping Yang, Berton Epler, and Pallab K. Chatterjee. An investigation of the charge conservation problem for mosfet circuit simulation. *IEEE Journal of Solid-State Circuits*, SC-18(1), February 1983.
- [23] BSIM3v3.1 Manual. Technical report, Department of Electrical Engineering and Computer Science, University of California, Berkeley, CA 94720.
- [24] J. C. Bowers and H. A. Neinhuis. SPICE2 Computer Models for HEXFETs. Technical Report Application Note 954A, International Rectifier Corporation, Berkeley, CA 94720.
- [25] K. M. Kramer and W. N. G. Hitchon. *Semiconductor Devices: A Simulation Approach*. Prentice-Hall, 1997.
- [26] C. D. Thurmond. The standard thermodynamic function of the formation of electrons and holes in ge, si, gaas, and gap. *J. Electrochem. Soc.*, 122:1133, 1975.
- [27] D.M. Caughey and R.E. Thomas. Carrier mobilities in silicon empirically related to doping and field. *Proc. IEEE*, 55:2192–2193, 1967.
- [28] N.D. Arora, J.R. Hauser, and D.J. Roulston. Electron and hole mobilities in silicon as a function of concentration and temperature. *IEEE Transactions on Electron Devices*, ED-29:292–295, 1982.
- [29] J.M. Dorkel and Ph. Leturq. Carrier mobilities in silicon semi-empirically related to temperature, doping, and injection level. *Solid-State Electronics*, 24(9):821–825, 1981.
- [30] C. Lombardi, S. Manzini, A. Saporito, and M. Vanzi. A physically based mobility model for numerical simulation of nonplanar devices. *IEEE Transactions on Computer-Aided Design*, 7(11):1164–1170, November 1988.
- [31] Ben G. Streetman and Sanjay Banerjee. *Solid State Electronic Devices*. Prentice-Hall, Upper Saddle River, New Jersey, 2000.
- [32] K.E. Brenan, S.L. Campbell, and L.R. Petzold. *Numerical Solution of Initial-Value Problems in Differential-Algebraic Equations*. Society for Industrial and Applied Mathematics, Philadelphia, 1996.



## Index

- .PREPROCESS, 69
  - ADDRESSISTORS, 70
  - REMOVEUNUSED, 70
  - REPLACEGROUND, 69
- Xyce**
  - ABSTOL, 296
  - RELTOL, 296
  - convergence, 295
- .FUNC, 43
- .GLOBAL\_PARAM, 45
- .INC, 44
- .MEASURE, 36
- .OPTIONS, 46, 300, 304, 306
- .PARAM, 44
- .PRINT
  - Expressions, 42
- .PRINT, 29, 30, 38
- .SUBCKT, 32
- ABSTOL, 49, 59
- BPENABLE, 54
- EXITSTEP, 55
- EXITTIME, 55
- MAXSTEP, 59
- NLNEARCONV, 50
- NLSMALLUPDATE, 50
- RELTOL, 49, 59
- RESTARTSTEPSCALE, 50
- .DC, 20
- .HB, 30
- .MPDE, 31
- .STEP, 23
- .TRAN, 27, 66
- RESTART, 67
- accelerated mass device, 263
- adms vbic
  - device model parameters, 112
- algorithm
  - time integration, 304, 306
- analysis
  - control parameters, 46
  - DC, 20, 57
    - Decade sweeps, 21
    - Linear sweeps, 20
    - List Sweeps, 22
    - Octave sweeps, 21
  - HB, 30
  - MPDE, 31
  - options, 46
  - STEP
    - Decade sweeps, 24
    - Linear sweeps, 23
    - List sweeps, 25
    - Octave sweeps, 25
  - step, 23
  - transient, 27, 29, 57
- Aztec, 64
- behavioral digital
  - instance parameters, 261
  - model parameters, 262
- bias point, 29

- BJT, 105
  - model parameters, 109
  - operating temperature, 107
- bsim3
  - device model parameters, 154
- bsim3 soi
  - device model parameters, 178
- bsim4
  - device instance parameters, 180
  - device model parameters, 208
- bsource, 104
- capacitor, 76
  - instance parameters, 77
  - model parameters, 78
- checkpoint, 67
  - format, 67
- ChileSPICE, 305, 307
- command line, 292
  - arguments, 291
- controlled switch, 254
  - model parameters, 256
- convergence, 295
- current controlled current source, 101
- current controlled voltage source, 102
- current source
  - current controlled, 101
  - independent, 95
  - nonlinear dependent, 104
  - voltage controlled, 103
- DC analysis, 20, 57
  - Decade sweeps, 21
  - Linear sweeps, 20
  - List sweeps, 22
  - Octave sweeps, 21
- device
  - ABM device
    - PSpice equivalent, 300
  - analog, 72
  - analog device summary, 74
  - B source, 72
  - bipolar junction transistor (BJT, 73
  - BJT, 105
  - bsource, 104
  - capacitor, 72, 76
  - controlled switch, 254
  - current controlled current source, 73, 101
  - current controlled switch, 73
  - current controlled voltage source, 73, 102
  - digital, 259
  - Digital Devices, 74
  - diode, 72, 89
  - equations, 72
  - generic switch, 257
  - independent current source, 73
  - independent voltage source, 73, 95, 99
  - inductor, 73, 79
  - JFET, 73, 116
  - lossless transmission line, 258
  - MESFET, 74, 119
  - MOSFET, 73, 122
  - mutual inductor, 73
  - mutualinductor, 81
  - nodes, 75
  - nonlinear dependent source, 72
  - package options, 47
  - PDE Devices, 74, 265
  - resistor, 73, 85
  - ROM Devices, 74
  - subcircuit, 73
  - transmission line, 73
  - voltage controlled current source, 73, 103
  - voltage controlled switch, 73
  - voltage controlled voltage source, 73, 100
- Digital Devices, 74
- digital devices, 259
- diode, 89
  - instance parameters, 90
  - model parameters, 91
  - operating temperature, 89

- ekv3 mosfet
  - device instance parameters, 239
  - device model parameters, 247
- generic switch, 257
- GUI, 299
- harmonic balance analysis, 30
- independent voltage source, 95, 99
- inductor, 79
  - model parameters, 80
- JFET, 116
- jfet
  - instance parameters, 117
  - model parameters, 118
- Lambert-W Function, 48
- lossless transmission line, 258
  - model parameters, 258
- MESFET, 119
- mesfet
  - instance parameters, 120
  - model parameters, 121
- mesh, 267, 268
- Microsoft Windows, 309
- model, 72
  - definition, 32
- MOSFET, 122
- mosfet level 1
  - device model parameters, 133
- mosfet level 2
  - device model parameters, 135
- mosfet level 3
  - device model parameters, 137
- mosfet level 6
  - device model parameters, 139
- mpde, 55, 57
- multi-time partial differential equation analysis, 31
- mutualinductor, 81
- netlist
  - commands, 20
  - comment, 45
  - in-line comment, 45
  - line continuation, 46
  - nodes, 75
  - reference, 19
- nonlinear mutual inductor
  - device model parameters, 83
- Operating Point, 20
- output
  - control, 36
- parallel
  - computing, 13
- parameters
  - convergence, 295
- PDE Devices, 74, 265
  - doping parameters, 269
  - electrode parameters, 270
  - instance parameters, 268
  - model parameters, 268
  - Physical Models, 271
  - time integration parameters, 53
- power mosfet
  - instance parameters, 208
  - model parameters, 211
- psp103va mosfet
  - device instance parameters, 212
  - device model parameters, 238
- PSpice, 299, 304
  - E device, 300
  - F device, 300
  - G device, 300
  - H device, 300
  - Probe, 40
- rawfile, 311

- ascii, 311
- binary, 311
- resistor, 85
  - device instance parameters, 87
  - device model parameters, 88
  - instance parameters, 86
  - model parameters, 86
- restart, 67
  - file, 68
  - format, 68
  - two-level, 68
- results
  - measure, 36
  - output control, 36
  - output options, 66
  - print, 29, 30, 38
- ROM Devices, 74
- Sandia National Laboratories, 13
- solvers
  - continuation
    - options, 62, 63
  - control parameters, 46
  - hb
    - options, 57
  - homotopy
    - options, 62
  - linear
    - Aztec, 64
    - iterative (preconditioned Krylov methods), 64
    - options, 64, 66
    - sparse-direct, 64
    - Trilinos, 64
  - nonlinear
    - options, 57, 62, 296
  - nonlinear-transient
    - options, 62
  - time integration
    - options, 295
    - time integration, 29, 304, 306
      - options, 49, 55
- STEP analysis
  - Decade sweeps, 24
  - Linear sweeps, 23
  - List sweeps, 25
  - Octave sweeps, 25
- step parametric analysis, 23
- subcircuit, 32, 72, 264
  - designation, 34
  - name, 33
  - nesting, 34
  - node zero, 34
  - scoping, 34
- TCAD Devices, 265
  - model parameters, 268
  - Physical Models, 271
- texttt.MEASURE, 36
- time step
  - size, 29, 304, 306
- transient analysis, 27, 57
  - error tolerances, 295
- Trilinos, 64
- Unix, 14
- Users of ChileSPICE, 305
- Users of PSpice, 299
- Users of Xyce on Microsoft Windows, 309
- voltage controlled current source, 103
- voltage controlled voltage source, 100
- Voltage Nodes, 75
- voltage source
  - current controlled, 102
  - independent, 99
  - nonlinear dependent, 104
  - voltage controlled, 100



## DISTRIBUTION:

1 Wendland Beezhold  
Idaho Accelerator Center  
1500 Alvin Ricken Drive  
Pocatello, Idaho 83201

Unless otherwise noted, all of the following copies were distributed electronically

1 MS 0316  
Keith Santarelli, 1412

1 MS 0316  
Joseph P. Castro, 1437

1 MS 0316  
Deborah Fixel, 1437

1 MS 0316  
Gary Hennigan, 1437

1 MS 0316  
Robert J. Hoekstra, 1437

1 MS 0316  
Eric R. Keiter, 1437

1 MS 0316  
Paul Lin, 1437

1 MS 0316  
Biliana Paskaleva, 1437

1 MS 0316  
Eric L. Rankin, 1437

1 MS 0316  
Thomas V. Russo, 1437

1 MS 0316  
Richard Schiek, 1437

1 MS 0316  
John N. Shadid, 1437

1 MS 0316  
Heidi K. Thornquist, 1437

1 MS 0321  
Jamesw Peery, 1400

1 MS 0321  
John Mitchiner, 1430

1 MS 0340  
Mark J. De Spain, 2123

1 MS 0344  
Joshua Michael Schare, 2626

1 MS 0348  
Markus Johannes Hoffmann,  
5351

1 MS 0348  
Garth M. Kraus, 5353

1 MS 0348  
George Laguna, 5351

1 MS 0348  
John Dye, 5351

1 MS 0351  
Charles Barbour, 1010

1 MS 0351  
H. Morgan, 1030

1 MS 0352  
Charles Hembree, 1344

1 MS 0352  
Steven D. Wix, 1734

1 MS 0352  
Teresa Gutierrez, 17311

- |  |  |
|--|--|
| 1 MS 0372<br>Stephen T. Montgomery, 1524 | 1 MS 0525<br>Regina Schells, 1734              |
| 1 MS 0382<br>Kenneth Noel Belcourt, 1543 | 1 MS 0529<br>Christopher L. Gibson, 5355       |
| 1 MS 0405<br>Ben Long, 0425              | 1 MS 0529<br>Steven Dunlap, 5356               |
| 1 MS 0405<br>C. W. Bogdan, 0425          | 1 MS 0635<br>Daniel R. Cantu, 2957             |
| 1 MS 0405<br>Glenn L. Rice, 0425         | 1 MS 0672<br>Zachary Benz, 5635                |
| 1 MS 0405<br>John L. Tenney, 0425        | 1 MS 0807<br>Philip M. Campbell, 9326          |
| 1 MS 0406<br>Jason Dimkoff, 5712         | 1 MS 0807<br>David N. Shirley, 9326            |
| 1 MS 0429<br>Ronald Hartwig, 2100        | 1 MS 0808<br>Shekita Lavette Robinson,<br>2132 |
| 1 MS 0447<br>Douglas R. Weiss, 2127      | 1 MS 0824<br>Joel Lash, 1510                   |
| 1 MS 0457<br>Robert Paulsen, 2011        | 1 MS 0828<br>Anthony A. Giunta, 1544           |
| 1 MS 0479<br>Scott Klenke, 2138          | 1 MS 0828<br>Vicente Romero, 1544              |
| 1 MS 0481<br>Christopher R. Landry, 2132 | 1 MS 0829<br>Brian Rutherford, 0415            |
| 1 MS 0503<br>Arthur J. Gariety, 5339     | 1 MS 0889<br>Neil R. Sorensen, 1825            |
| 1 MS 0525<br>Adam H. Lester, 1732        | 1 MS 0899<br>Technical Library, 9536           |
| 1 MS 0525<br>Albert V. Nunez, 1734       | 1 MS 0956<br>Steven C. Anderson, 2434          |
|  | 1 MS 1056<br>Edward Bielejec, 1111             |

- |   |  |
|---|--|
| 1 MS 1056<br>Gyorgy Vizkelethy, 1111          | 1 MS 1146<br>Patrick Grifn, 1384                 |
| 1 MS 1056<br>William Wampler, 1111            | 1 MS 1152<br>Michael F. Pasik, 1654              |
| 1 MS 1069<br>Glenn Omdahl, 1711               | 1 MS 1153<br>Larry D. Bacon, 5443                |
| 1 MS 1071<br>Dahlon Chu, 1730                 | 1 MS 1153<br>Robert A. Salazar, 5443             |
| 1 MS 1072<br>Nathan Nowlin, 1731              | 1 MS 1159<br>James Bryson, 1344                  |
| 1 MS 1072<br>Richard Flores, 1731             | 1 MS 1159<br>Kyle McDonald, 1344                 |
| 1 MS 1073<br>G. Ronald Anderson, 1717         | 1 MS 1159<br>Victor Harper-Slaboszewicz,<br>1344 |
| 1 MS 1076<br>Alan F. Lundin, 1737             | 1 MS 1165<br>Paul N. Demmie, 5435                |
| 1 MS 1083<br>Kenneth E. Kambour, 17311        | 1 MS 1167<br>St. Dominic Bonaparte, 1343         |
| 1 MS 1083<br>Paul Dodd, 17311                 | 1 MS 1179<br>Harry Hjalmarson, 1341              |
| 1 MS 1084<br>Timothy L. Meisenheimer,<br>1748 | 1 MS 1179<br>Leonard Lorence, 1341               |
| 1 MS 1085<br>Albert Baca, 1742                | 1 MS 1179<br>Mark Hedemann, 1340                 |
| 1 MS 1137<br>Greg D. Valdez, 6323             | 1 MS 1182<br>Derek C. Lamppa, 5445               |
| 1 MS 1138<br>Harvey C. Ogden, 6325            | 1 MS 1188<br>Christina E. Warrender, 6343        |
| 1 MS 1146<br>Donald King, 1384                | 1 MS 1219<br>Charles L. Kandra,, 5924            |
|   | 1 MS 1316<br>Elebeoba E. May, 1412               |

- 
- |   |   |
|---|---|
| 1 MS 1316<br>Mark D. Rintoul, 1412              | 1 MS 1322<br>John Aidun, 1435           |
| 1 MS 1318<br>Brian M. Adams, 1411               | 1 MS 1322<br>Sudip Dosanjh, 1420        |
| 1 MS 1318<br>Karen Devine, 1416                 | 1 MS 1385<br>Ken Mulder, 1143           |
| 1 MS 1318<br>Mike Eldred, 1411                  | 1 MS 1411<br>Allen Roach, 1814          |
| 1 MS 1318<br>Bruce Hendrickson, 1410            | 1 MS 1411<br>Edmund B. Webb III, 1814   |
| 1 MS 1318<br>Roger Pawlowski, 1414              | 1 MS 1415<br>David Sandison, 1110       |
| 1 MS 1318<br>Andrew Salinger, 1414              | 1 MS 1415<br>Robert Fleming, 1123       |
| 1 MS 1318<br>Laura Swiler, 1411                 | 1 MS 1415<br>Samuel Myers, 1110         |
| 1 MS 1318<br>Bart van Bloemen Waanders,<br>1414 | 1 MS 9003<br>Donna J. O'Connell, 8112   |
| 1 MS 1319<br>Arun F. Rodrigues, 1422            | 1 MS 9003<br>Karen L. Jefferson, 8112   |
| 1 MS 1319<br>William C. McLendon III, 1423      | 1 MS 9004<br>Gary K. Lum, 8100          |
| 1 MS 1320<br>Todd Coffey, 1414                  | 1 MS 9004<br>William Ballard, 8100      |
| 1 MS 1320<br>David Day, 1414                    | 1 MS 9007<br>Brian Owens, 8205          |
| 1 MS 1320<br>Mike Heroux, 1416                  | 1 MS 9007<br>Dean F. Clark, 8205        |
| 1 MS 1320<br>James Willenbring, 1416            | 1 MS 9007<br>Elizabeth C. Wichman, 8205 |
|   | 1 MS 9013<br>Derek I. Koida, 8231       |

- |                                   |   |
|-----------------------------------|---|
| 1 MS 9013<br>Lee D. Druxman, 8231 | 1 MS 9106<br>Daniel Dominguez Jr., 8226 |
| 1 MS 9102<br>David Council, 8229  | 1 MS 9106<br>Steven Paradise, 8226      |
| 1 MS 9102<br>Jim He, 8135         | 1 MS 9158<br>Ting Mei, 1437             |
| 1 MS 9102<br>Kevin Lam, 8135      | 1 MS 9159<br>Genetha Gray, 8964         |
| 1 MS 9102<br>Rex I. Eastin, 8135  |   |
| 1 MS 9103<br>Cheryl Lam, 8942     | 1 MS 0899<br>Technical Library, 9536    |