

PAPER • OPEN ACCESS

## The dynamic synthesis time-lag control for the 1.3 GHz LCLS-II Cryomodule test at Fermilab

To cite this article: Liuji Pei *et al* 2020 *IOP Conf. Ser.: Mater. Sci. Eng.* **755** 012072

View the [article online](#) for updates and enhancements.

# The dynamic synthesis time-lag control for the 1.3 GHz LCLS-II Cryomodule test at Fermilab

Liujin Pei, Ben Hansen, Jay Theilacker, Qing Pei

*Fermi National Accelerator Laboratory, Batavia, IL, 60510, USA*

**Abstract-**The 1.3GHz LCLS-II Cryomodule (CM) has 8 cavities and each cavity has 9 RF cells and 80W heater. The 1.3GHz LCLS-II CM is 12.2-meter-long and contains a total 241.3 liters (equivalent liquid) of liquid helium, which is filling up by the 4KW@2.0K cryogenic plant at the Fermilab Cryomodule Test Facility (CMTF). The dynamic synthesis 2K cryogenic control system is built to control the long time-lag, unstable CM cryogenic system, under different modes operations. A report on the results obtained from the dynamic synthesis long time-lag control in the CMTF 1.3GHz CM test will be presented.

**Index:** long time-lag, unstable cryogenic control system, dynamic synthesis control

## I. INTRODUCTION

The large volume cryomodules, high volumetric flow rate and high helium vapor velocity of the smaller Joule-Thomson (JT) valve contributed to some PID operational difficulties in its liquid level and pressure. Figure 1 is the cryomodule, Figure 2 shown the cryomodule layout, Figure 3 illustrates the cryomodule piping arrangement.



Figure 1. The 1.3GHz LCLS-II 12.2-meter-long SRF cryomodule made by Fermilab.

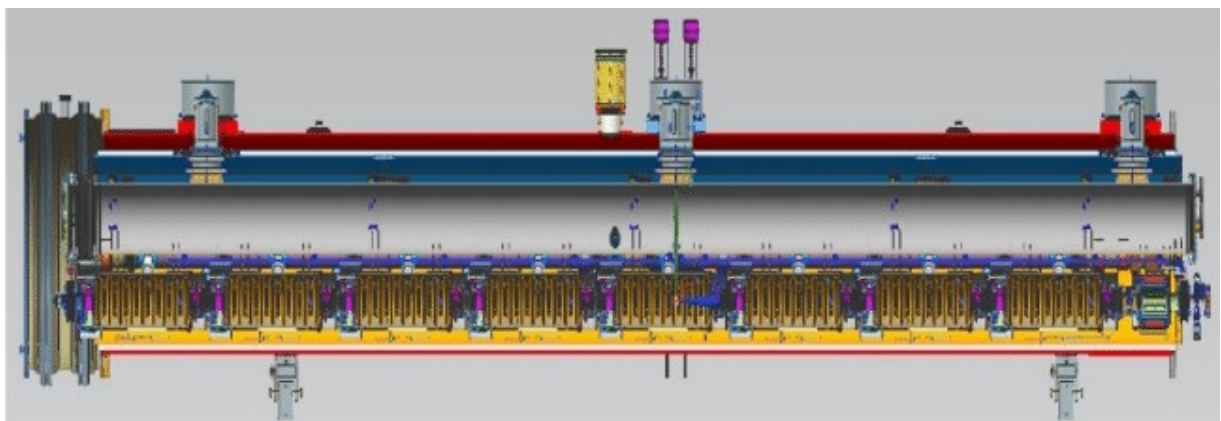

Figure 2. The 1.3GHz LCLS-II Cryomodule layout.



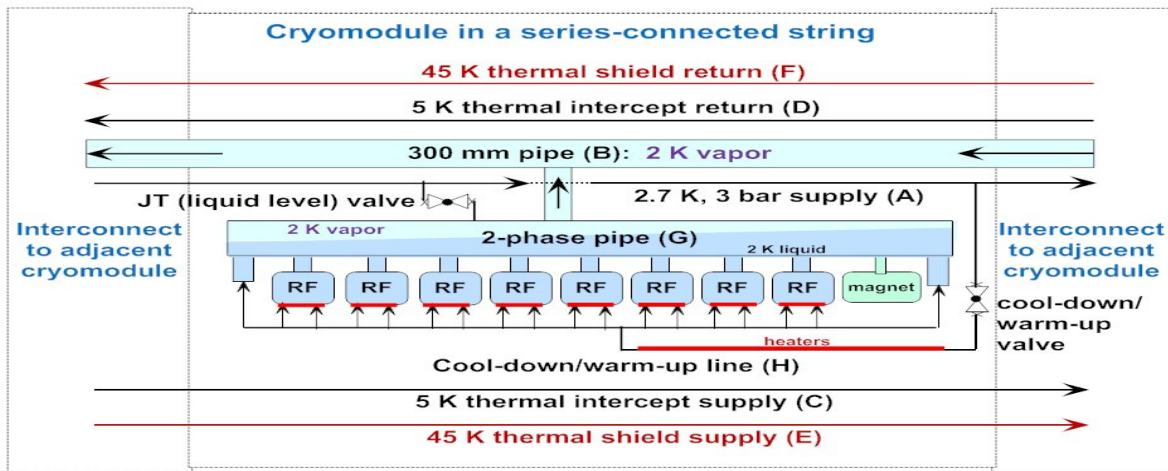

Figure 3. Cryomodule helium flow schematic.

The line A provides the approximately 3 bar pressures and 2.7 Kelvin liquid helium to the cryomodules. The JT DN5 valve ( $C_v + eq\%$ ) PID control provides range 0 to 10 g/s two phase helium (liquid and gas) from Line A to the 241.3 liters RF cavity helium vessels by maintaining a liquid level in the 2-phase pipe.

## II. THE LONG TIME-LAG SYSTEM USING COMMON PID CONTROL

Higher temperature liquid helium (LHe) into the JT expansion valve results in a significant fraction of the helium flow through the valve flashing immediately to vapor at the low pressure (31 mbar), 2 Kelvin, valve exit. Above 4.6K results in more than 45% of the flow just passing through the 2-phase pipe and out to the line B, 300mm gas return pipe, as vapor, but 2.7K results in just 20%. So, the liquid level in the 2-phase pipe respond will be very slow to JT position change under the common PID control as shown in Figure 4, and even worse when RF power operates at 80W maximum range. Overall, the common PID Loop control will result in the cryomodules cryogenic system to oscillation and take longer time to stabilize if could. The Figure 4 shown the time spent of the common PID loop control for 8 hours with constant heat load (89.5% CLL301 setpoint).

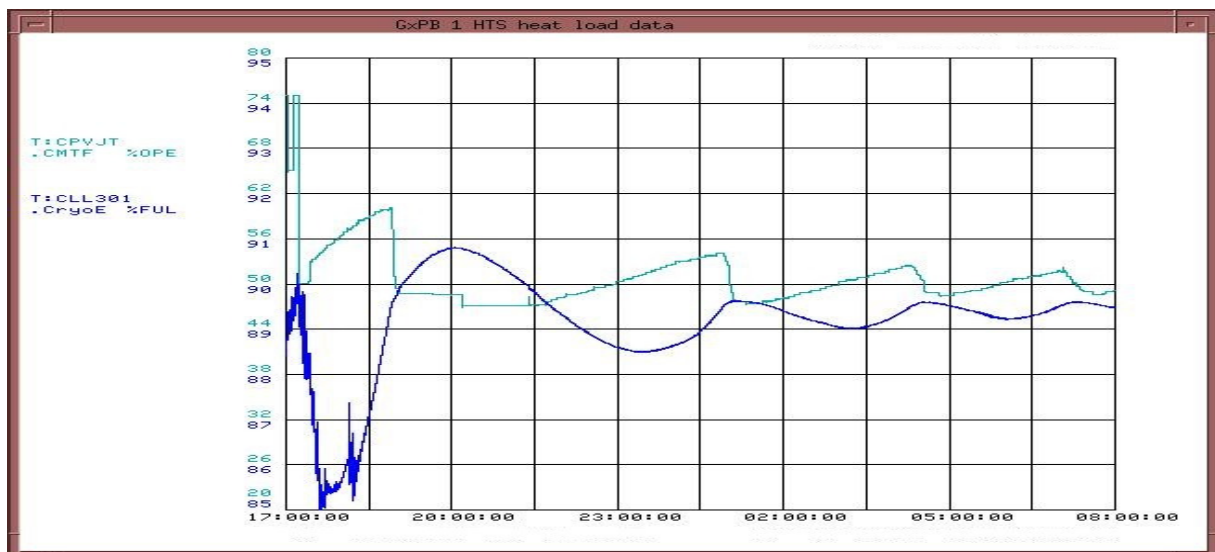

Figure 4. Common PID Loop control

### III. SYSTEM ANALYSIS AND NEW CONTROL ALGORITHM DESIGN

If balancing the cryogenic system with different preconditions, it is possible that they will respond differently for the same kind of control. For this reason, at least, the adaptive mechanisms are needed, capable of observing the reactions of the system and modifying their parameters to improve the given control algorithm.

The decisions taken by the control algorithm may depend upon the observation of various system responds. Creating a single control algorithm that contains this knowledge includes all of the possible system responses with the different combination of its settings is a highly complex task, if not impossible and may need considerably large data. We solve this problem by subdividing the control algorithm into several subdivision control algorithms. This gives us the possibility of describing the subdivision control behavior focusing on its specific parameters and using less data for each subdivision control. Then, the dynamic synthesis long time-lag control is applied to create a real-time, on-line, long time-lag system control. To get the best control results, the fuzzy algorithm, the model predictive algorithm and the adaptive algorithm will dynamically combine into the dynamic synthesis control algorithm using the information of the subdivision control. This dynamic synthesis time-lag control can automatically modify its synthesis control algorithm by observing the response of the cryogenic system in comparison to what is expected.

The dynamic synthesis control algorithm is shown in Figure 5. It consists of the pre-estimated optimal algorithm control, the error subzone PID control and the weight arithmetic means control.

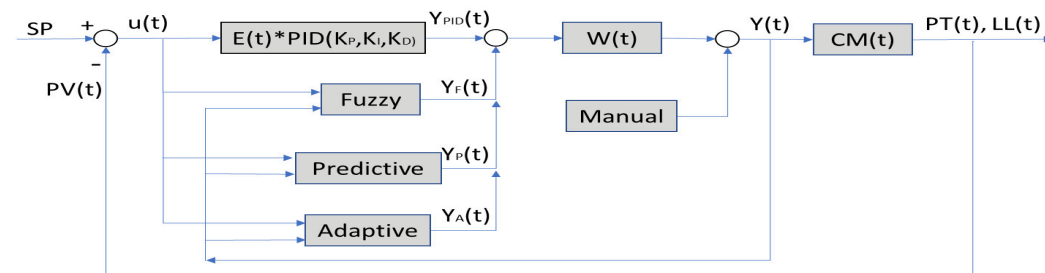

Figure 5. the dynamic synthesis control algorithm block flow

Due to the slow liquid level response time of small JT valve changes. Three types of pre-estimated optimal algorithm controls are selected.

#### A. The fuzzy algorithm control $Y_F(t)$

The basic configuration of a fuzzy algorithm system shown in figure 6 is based on a fuzzification block gathering all the inputs of the system and its corresponding sets, a rule-base, an inference mechanism and defuzzification. To this configuration additional scaling factors were introduced to the inputs (x) and output (Y). This allows the easy configuration of the range of values covered by the fuzzy sets.

Because of the system time lag is usually more than several minutes to hours, and system control cycle is on the scale of hours. The ideal real-time control system should estimate its JT valve control partial true direction based on the fuzzy algorithm which could calculate current operated data.

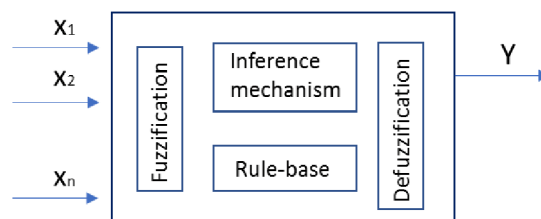

Fig. 6. Fuzzy controller architecture

B. *The model predictive algorithm control  $Y_p(t)$*

To estimate the JT position better and faster control result when control condition setting has a sudden change, for instant, the big RF electric field strength or heater power change, the real-time control system should be able to predict and feed-forward its JT valve moving direction as well as position based on those data had been saved.

C. *The adaptive algorithm control  $Y_A(t)$*

At the beginning the previously defined fuzzy and model predictive control algorithms will not be optimally tuned-up for all the possible scenarios and specific event reactions. Therefore, an adaptive mechanism is needed capable of recognizing when a big unknow change must be made and how the control parameters should be modified. It is difficult to detect how the parameters should be changed in each control steps, this was solved by introducing a self-learning adaptive algorithm that can adjust its own parameters. This adaptive control algorithm uses the same inputs as the knowledge fuzzy base and model predictive control algorithms together with additional self-learning method that help to characterize a specific situation, e.g. refrigerator plant liquid helium supply disturbing.

D. *The dynamic synthesis control equation for the long time-lag system*

Finally, the dynamic synthesis control equation  $Y(t)$  is divided by sub zones. There are:

- a) When  $E1 < e < E2$ , then

$$Y(t) = \sum X_1 Y_{PID}(t) + X_2 Y_F(t) + X_3 Y_p(t) + X_4 Y_A(t)$$

where, weight arithmetic means  $\sum_{i=1}^4 X_i = 1$

- b) When  $e > E2$ , then

$$Y(t) = Y_{PID}(t)$$

- c) When  $e < E1$ , then

$$Y(t) = \sum (Y_{PID}(t) + X_f Y_F(t) + X_i Y_p(t) + X_a Y_A(t)) / 2$$

where, weight arithmetic means  $\sum X_f + X_i + X_a = 1$

#### IV. REAL SYSTEM TEST RESULT

The real-time synoptic remote control viewer is shown as Figure 7 as used on LCLS II Cryomodule. It was operating on 2K situation in the supercritical mode. Its dewar liquid helium leve CLL301 was 90%, Its cryogenic module pressure CPT302 was 22.95 torr.

- A. The cryomodule was cooled down from room temperature 230K to 2K supercritical mode.

The Cryomodule cooldown period is shown in figure 8. The CPVJT setpoint for CLL301 was 90%, the pressure CPT302 setpoint was 23 torr (23 torr=30.664 mbar). The CM cool down time took less than four hours while its CM temperature downed to 2K from 230 K, its CM pressure CPT302 downed to 23 torr from atmosphere, and its CM dewar liquid helium level rose to 90% from zero.

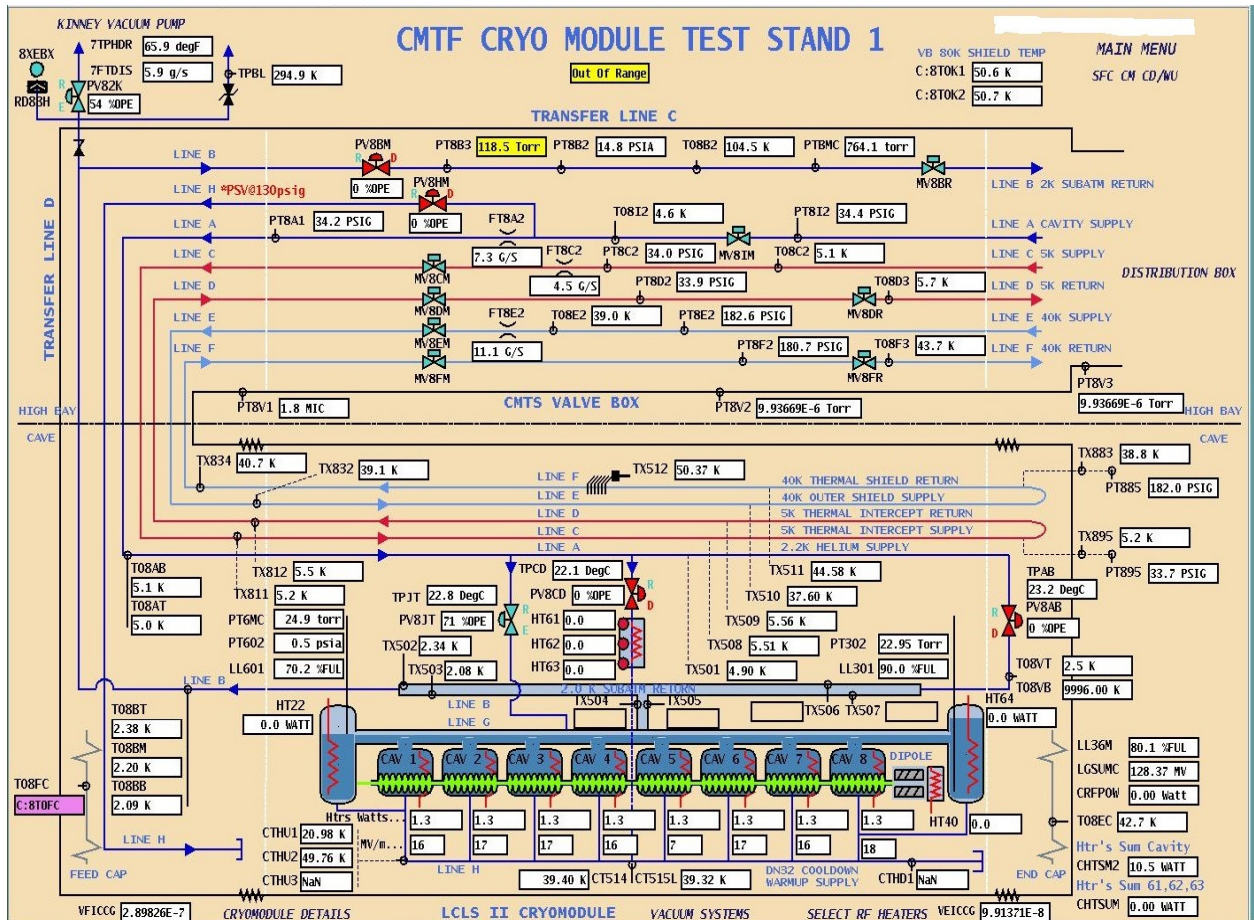

Figure 7. Real-time synoptic control view of LCLS-II Cryomodule

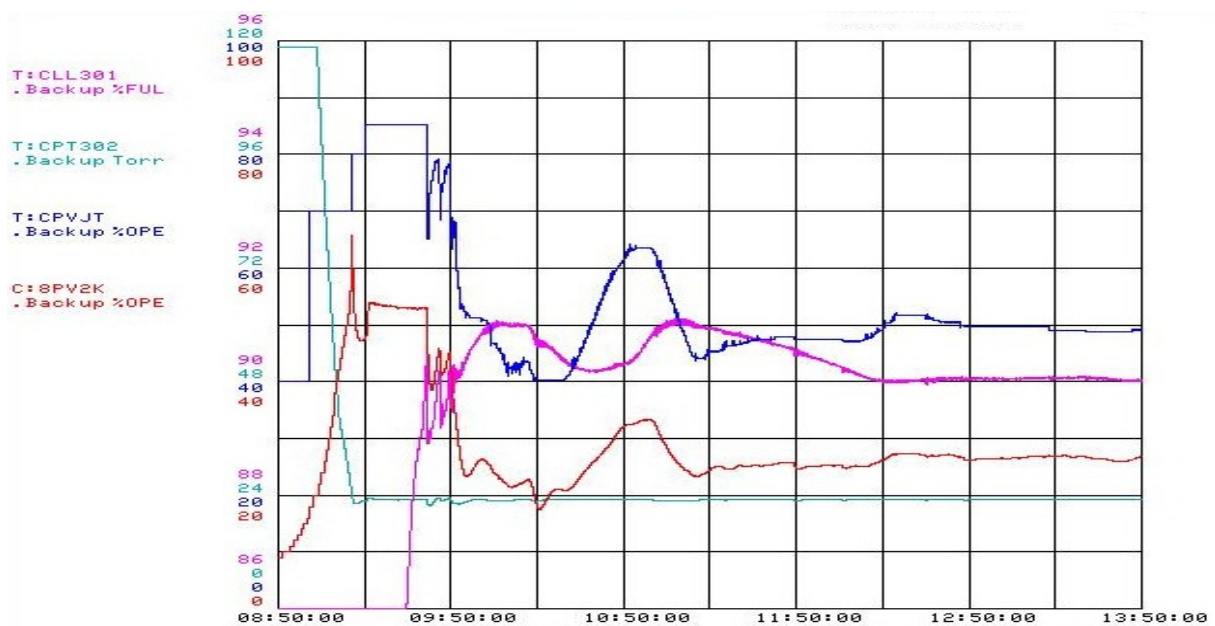

Fig. 8. The cryomodule was cooled down to 2K from room temperature.

B. The cryomodule pressure regulation with JT valve and 2K valve only.

While the CM RF electric field strength (MV/M) and heater load change, the CM CPT302 pressure regulation with 8PV2K valve is shown in Figure 9. The CPVJT valve setpoint for liquid level CLL301 was 90.5%, the 8PV2K valve setpoint for pressure CPT302 was 23 torr.

Without using the dewar heaters, the cryomodule pressure CPT302 and CM liquid level CLL301 were only regulating by those valves of the 8PV2K and the CPVJT which using the dynamic synthesis time-lag control. In this case, the CPVJT valve raised ~34% to compensate with its RF heater load rose to 70 watts step by step, then dropped to 10 watts. Its CM RF electric field strength added to 128 Megavolt/Meter from zero at similar time. But its cryomodule pressure CPT302 is still stable in the range +/- 0.3 torr after end of the RF power and electric field strength transition.

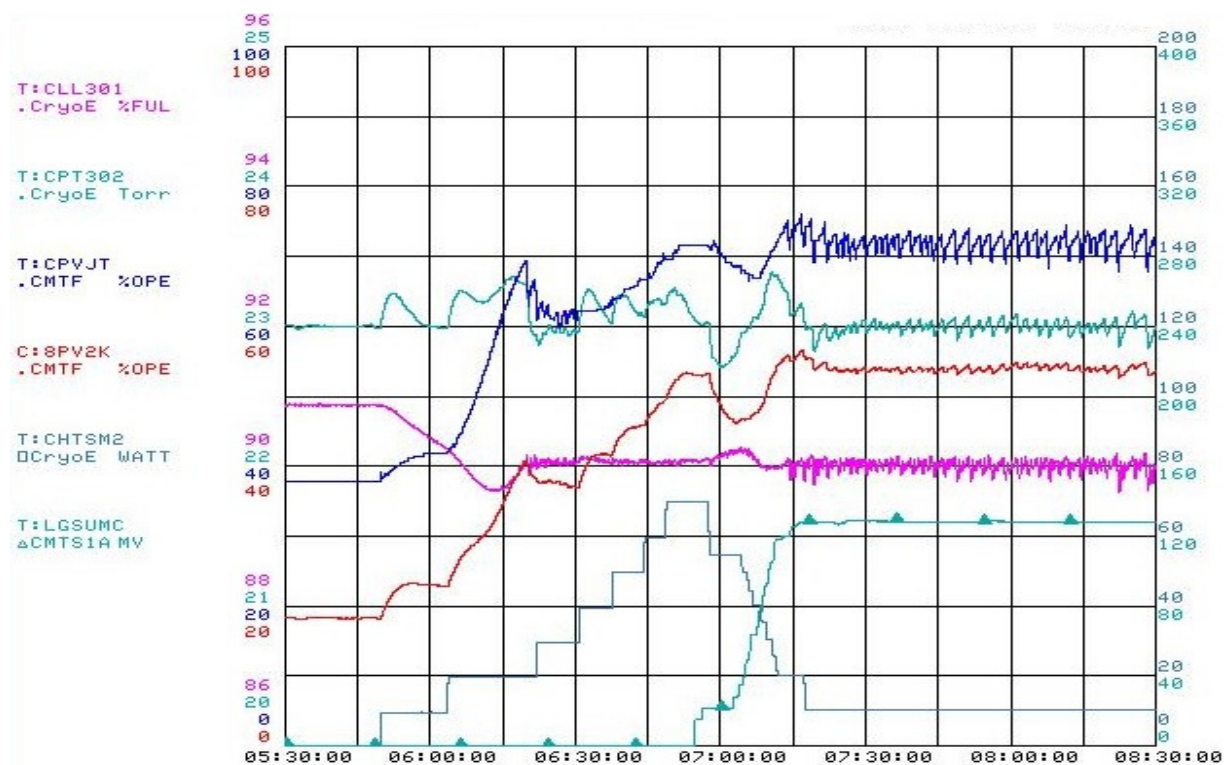

Figure 9. The cryomodule pressure regulation with CPVJT valve and 8PV2K valve only

## V. CONCLUSION

The presented dynamic synthesis time-lag control could apply for all types of the long time-lag cryogenic system even if couldn't have previous knowledge on how to control the system. However, to assure best control for the stabilization, the control system would be learning and adapting by itself automatically.

That comments came from user at Jan 25, 2018.

“Presented at the meeting and was again astonished by the basic assumption that some people have about cavity frequency drift. They assume that the JT valve motors are going to be moving constantly because the

cavities are going to be drifting in temperature and pressure, while I'm sitting here looking at plots of frequencies stable to 2 Hz over 8 hours. Certainly, a credit to all of you guys”.

## VI. Acknowledgments

This manuscript has been authored by Fermi Research Alliance, LLC under Contract No. DE-AC02-07CH11359 with the U.S. Department of Energy, Office of Science, Office of High Energy Physics. The United States Government retains and the publisher, by accepting the article for publication, acknowledges that the United States Government retains a non-exclusive, paid-up, irrevocable, world-wide license to publish or reproduce the published form of this manuscript, or allow others to do so, for United States Government purposes.

The authors wish to recognize the dedication and skills of the Cryogenics Sector of Applied Physics and Superconducting Technology Division technical personnel involved in the operation of this system.

## REFERENCES

- [1] *Alejandro Mendoza Garcia*, “Application of Adaptive Fuzzy Controllers for the Automation of Medical Devices”. *FUZZ IEEE, WCCI 2012 IEEE World Congress on Computational Intelligence June, 10-15, 2012 - Brisbane, Australia*
- [2] *B. Baumgartner, A. Mendoza Garcia, U. Schreiber, S. Eichhorn, M. Krane, R. Bauernschmitt, and A. Knoll*, “A comprehensive approach towards extra-corporal circulation control using fuzzy logic,” *Fuzzy Systems (FUZZ), 2010 IEEE International Conference on*, pp. 1–5, July 2010.
- [3] *J. Leibfritz et al.*, “Status and plans for a SRF accelerator test facility at Fermilab” *PAC’11, New York, April 2011*.
- [4] *L. Pei, et al.*, “The Fermilab CMTF cryogenic distribution remote control system” *American Institute of Physics, Melville, New York, 2014*, pp. 1713-1719
- [5] *A. Martinez, et al.*, “Design and testing of the New Muon Lab cryogenic system at Fermilab” *American Institute of Physics Conf. Proc. 1218 (2010) 488-495*