

R-01-27

The biosphere today and tomorrow in the SFR area

Ulrik Kautsky (editor)

Svensk Kärnbränslehantering AB

June 2001

Svensk Kärnbränslehantering AB

Swedish Nuclear Fuel
and Waste Management Co
Box 5864

SE-102 40 Stockholm Sweden

Tel 08-459 84 00

+46 8 459 84 00

Fax 08-661 57 19

+46 8 661 57 19



ISSN 1402-3091

SKB Rapport R-01-27

The biosphere today and tomorrow in the SFR area

Ulrik Kautsky (editor)

Svensk Kärnbränslehantering AB

June 2001

Abstract

This report is a compilation of the work done mainly in the SAFE project for the biosphere from about 14 reports. The SAFE project is the updated safety analysis of SFR-1, the LLW and ILW repository at Forsmark. The aim of the report is to summarize the available information about the present-day biosphere in the area surrounding SFR and to use this information, together with information about the previous development of the biosphere, to predict the future development of the area in a more comparable way than the underlying reports. The data actually used for the models have been taken from the original reports which also justify or validate the data.

The report compiles information about climate, oceanography, landscape, sedimentation, shoreline displacement, marine, lake and terrestrial ecosystems.

Contents

Abstract	3
Contents	5
1 Introduction	11
1.1 Reports used in this compilation	13
2 Biosphere matrix	15
2.1 Introduction	15
2.2 Diagonal elements – system state variables	19
2.3 Quaternary deposits	21
2.3.1 Relocation	21
2.3.2 Bioturbation	21
2.3.3 Change in water content	22
2.3.4 Erosion	22
2.3.5 Sedimentation	22
2.3.6 External boundary – land rise	22
2.4 Primary producers	22
2.4.1 Settlement	22
2.4.2 Feeding	23
2.4.3 Stimulation/inhibition	23
2.4.4 Water uptake	23
2.4.5 Light attenuation	23
2.4.6 Insolation	24
2.4.7 Exposure	24
2.4.8 Import and export	24
2.5 Decomposers	24
2.5.1 Settlement	24
2.5.2 Consumption	24
2.5.3 Food supply	25
2.5.4 Feeding	25
2.5.5 Stimulation/inhibition	25
2.5.6 Water uptake	25
2.5.7 Exposure	25
2.6 Filter feeders	25
2.6.1 Settlement	25
2.6.2 Stimulation/inhibition	26
2.6.3 Exposure	26
2.7 Herbivores	26
2.7.1 Settlement	26
2.7.2 Consumption	26
2.7.3 Food supply	27
2.7.4 Stimulation/inhibition	27
2.7.5 Water uptake	27
2.7.6 Exposure	27

2.8	Carnivores	27
	2.8.1 Settlement	27
	2.8.2 Food supply and feeding	28
	2.8.3 Stimulation/inhibition	28
	2.8.4 Exposure	28
2.9	Humans	28
	2.9.1 Settlement – living and building	28
	2.9.2 Food supply	28
	2.9.3 Material supply	29
	2.9.4 Water use	29
	2.9.5 Stimulation/inhibition	29
	2.9.6 Exposure	29
2.10	Water in quaternary deposits	29
	2.10.1 Water transport	29
	2.10.2 Recharge/discharge	30
	2.10.3 Evaporation/condensation	30
	2.10.4 Water extraction	30
	2.10.5 External boundary conditions – import	30
2.11	Surface water	30
	2.11.1 Discharge/recharge	30
	2.11.2 Water transport and convection	30
	2.11.3 Wind stress and wave formation	31
	2.11.4 Movement – human induced	31
	2.11.5 Evaporation/condensation	31
	2.11.6 Precipitation	31
	2.11.7 External boundary conditions – sea currents	31
	2.11.8 External boundary conditions – sea level changes	32
2.12	Water composition	32
	2.12.1 Boundary condition – mass flux	32
	2.12.2 Re-suspension	32
	2.12.3 Uptake/excretion	32
	2.12.4 Particle production and trapping	32
	2.12.5 Mixing	33
	2.12.6 Property changes	33
	2.12.7 External boundary condition – import	33
2.13	Gas – atmosphere	33
	2.13.1 Boundary condition – gas transport	33
	2.13.2 Re-suspension	33
	2.13.3 Particle production – trapping	33
	2.13.4 External boundaries – import	34
2.14	Temperature	34
	2.14.1 Heat storage	34
	2.14.2 Heat driven convection	34
	2.14.3 Light absorption	34
	2.14.4 External boundaries – import of heat	34
2.15	Radionuclides and toxins	34
	2.15.1 Boundary condition – release from the geosphere	35
	2.15.2 Sorption/desorption	35
	2.15.3 Sorption/uptake and excretion	35
	2.15.4 Degradation	35

2.15.5	Growth	35
2.15.6	Mixing	36
2.15.7	Phase transitions	36
2.15.8	Decay	36
2.15.9	External boundaries – export	36
2.16	Reference	36
3	Climate	37
3.1	Today	37
3.2	Future development, general	39
3.3	References	39
4	Study areas	41
4.1	Baltic Sea	41
4.2	Öregrundsgrepen	42
4.2.1	Freshwater discharge	43
4.2.2	Ice dynamics	44
4.3	Local model area	44
4.4	References	45
5	Shore level displacement	47
5.1	Introduction	47
5.2	Today	48
5.2.1	Öregrundsgrepen	48
5.2.2	Local model area	49
5.3	Future development	50
5.3.1	Öregrundsgrepen	50
5.3.2	Local model area	54
5.3.3	Hypsographic data 4,000 AD	56
5.3.4	Position of the discharge zone	57
5.4	References	57
6	Deposits/sedimentation	59
6.1	Deposits in terrestrial environments	59
6.2	Distribution of sediments	59
6.2.1	Baltic Sea	59
6.2.2	Öregrundsgrepen and local model area	59
6.3	Development of erosion/accumulation bottoms	61
6.3.1	General development	63
6.3.2	Outer model area – up to the present day	64
6.4	Sediment characteristics	66
6.5	References	66
7	Water turnover	67
7.1	Water turnover in the Baltic Sea	67
7.2	Water turnover in Öregrundsgrepen and the local model area	67
7.2.1	Exchange mechanisms in Öregrundsgrepen	67
7.2.2	Modelling the water exchange	68
7.2.3	Predicted water exchange in Öregrundsgrepen	68
7.2.4	Predicted water exchange in the local model area	72

7.3	Future development	75
7.3.1	10,000 years	76
7.4	References	81
8	Salinity	83
8.1	Today	83
8.1.1	Baltic Sea	83
8.1.2	Öregrundsgrepen	85
8.2	Future development	88
8.2.1	Baltic Sea	88
8.2.2	Öregrundsgrepen	89
8.3	References	89
9	Coastal area	91
9.1	Ecosystem structure, present day	91
9.1.1	The pelagic community	91
9.1.2	Bottom vegetation	91
9.1.3	Bottom fauna	93
9.1.4	Fish	93
9.1.5	Birds and seals in the area	93
9.2	Ecosystem function	93
9.3	Future development	95
9.4	References	97
10	Surrounding land	99
10.1	Present	99
10.1.1	Land classes and vegetation description	100
10.1.2	Fauna	102
10.1.3	Production and energy flow in terrestrial communities	102
10.2	Future development	104
10.2.1	Succession	104
10.2.2	Future vegetation of the model area	108
10.2.3	The vegetation year 3,000 AD	109
10.2.4	The vegetation, year 4,000 AD	110
10.2.5	The vegetation year 5,000 AD	111
10.2.6	General conclusions	112
10.3	References	112
11	Surrounding lakes	113
11.1	Introduction	113
11.2	Present day	113
11.2.1	Identification of characteristic lake-types within the Forsmark area	115
11.3	Lake characteristics	116
11.3.1	Oligotrophic hardwater lakes	116
11.3.2	Brownwater lakes	119
11.3.3	Deep eutrophic lakes	122
11.4	Water biology	125

11.5	Ecosystem function	126
	11.5.1 Oligotrophic hardwater lakes	126
	11.5.2 Brownwater lakes	129
	11.5.3 Deep eutrophic lakes	131
11.6	Future development	133
	11.6.1 Ontogeny of the oligotrophic hardwater lakes in the Forsmark area	133
	11.6.2 Ontogeny of the brownwater lakes of the Forsmark area	135
	11.6.3 Ontogeny of the deep eutrophic lake type	136
	11.6.4 The formation of new lake basins in the Forsmark area during the coming 10,000 years	136
	11.6.5 Development of Lake 4, first 1,000 years	137
11.7	References	140
12	Human society	145
12.1	Population	145
12.2	Farming practices	146
12.3	Wells	146
	12.3.1 Introduction	146
	12.3.2 Spatial distribution of wells	147
	12.3.3 Temporal distribution of well	148
	12.3.4 Future wells in the repository area	150
12.4	References	150
13	Future – a synthesis of the general development of the surface ecosystems	151
13.1	Climate	151
13.2	Shoreline displacement and lake development	152
13.3	The first 1,000 years (to 3,000 AD)	152
13.4	3,000 AD–4,900 AD (archipelago development)	152
13.5	4,900 AD–7,500 AD (lake development)	154
13.6	7,500 AD– (land period)	155

1 Introduction

This report is a summary of the results of several biosphere studies that were performed within SKB:s SAFE project. The SAFE project is a renewed safety analysis of the Final Repository of Radioactive Operational Waste (SFR).

The aim of this report is to provide information about the present-day biosphere in the area surrounding SFR and to use this information together with information about the previous development of the biosphere to predict the future development of the area. The main emphasis of the report is to give a synthesis of the development of the surface ecosystem in the area, based on the information on specific topics addressed in the underlying reports. The report gives a brief overview of the biosphere studies. For more detailed information, reference should be made to the underlying reports, listed in the reference list at the end of this chapter. In addition, this report presents new information about wells and their occurrence, which is not reported elsewhere.

The underground storage area of SFR is located in the bedrock beneath Öregrundsgrepen, a part of the Baltic Sea situated about 150 kilometers north of Stockholm. The safety analysis should, according to regulations, consider a period of at least 10,000 years, during which substantial changes will occur in the biosphere. For the first thousand years after closure, the analysis should be based on quantitative analyses of the effects on man. For the period after the first thousand years, the analysis should be based on probable scenarios for the development of the biosphere. A comparison should be also made with today's biosphere.

The general structure of the chapters is a presentation of today's biosphere and its development, the biosphere as predicted for 1,000 years from now, and finally, the biosphere as predicted during the period up to 10,000 years from today. The reports from which the information is derived are listed at the beginning of each chapter. Only additional references are then cited in this report. Citations of the information presented in this report should refer to the original, underlying reports, not to this document.

Chapter 2 of the report describes the biosphere processes and their interactions for the biosphere at their site. The description is made in a structured system, using the interaction matrix method.

A description of the current climate and its possible development is given in Chapter 3.

Three aquatic areas, the Baltic Sea, Öregrundsgrepen and a part of Öregrundsgrepen known as the local model area, are briefly described in Chapter 4, where basic data such as volumes, depths and fresh-water inflow are given.

Results of modeling the shore displacement in Öregrundsgrepen and the local model area are presented in Chapter 5. These studies form a basis for prognoses of the development of the area, see Chapter 9 and 11.

Shore displacement causes the creation of freshwater lakes, as well as changes in the conditions in deposits and sediments. Typical effects are alterations of the distribution

of erosion and accumulation bottoms with time, described among other things in Chapter 6.

Water turnover is an essential process for transport of contaminants. Water retention times in various water layers of Öregrundsgrepen and the local model area have therefore been calculated with a three-dimensional model. These model studies are described in Chapter 7. Results of the calculations are used, for example, in a model for the dynamics of carbon in the local model area, as well as in the safety assessments.

In addition to water turnover, salinity is a determining factor for the type of ecosystem that develops in aquatic areas. The results of studies of current salinity conditions and their future development are therefore summarized in Chapter 8.

Chapter 9 summarizes the current structure and function of the current ecosystem at the local model area and of the ecosystem predicted for 4,000 AD (the end stage of the brackish environment). A model for the dynamics of carbon in the aquatic ecosystem, for the present day and for 4,000 AD is presented.

New terrestrial areas are continuously emerging from the sea because of the shore level displacement. Development of the terrestrial areas at the site is summarized in Chapter 10. The current vegetation of the surrounding land is described together with prognoses of vegetation development in water-covered areas that will eventually be transformed to land.

A thorough documentation of current drainage areas in the Forsmark area was carried out in order to form a basis for predictions of the type of lakes that will be formed in the future. Data from present-day lakes was used as a basis for the prediction of the characteristics and ontogeny of the lake systems over the next 10,000 years. A summary of these studies is given in Chapter 11.

Chapter 12 gives a brief description of the human population and its activities in the area, e.g. information about the occurrence of wells in the Forsmark area.

Finally, a synthesis of the development of the surface ecosystem is presented in Chapter 13.

The reports that form the basis of this compilation are listed in section 1.1, below. The authors of these reports have carried out most of the work within the project. For an explanation of latin names, see the glossary in /Brunberg and Blomqvist, 2000/ and /Jerling et al., 2001/. The data used for the models are taken from the original reports and any discrepancies between this report and the original have been introduced by the editor.

This report has been prepared by Celia Jones and Sara Södergren, Kemakta Konsult AB, and edited by Ulrik Kautsky, SKB, with the help of Ulla Bergström, Studsvik Eco & Safety AB.

1.1 Reports used in this compilation

- Brunberg AK, Blomqvist P, 1999.** Characteristics and ontogeny of oligotrophic hardwater lakes in the Forsmark area, central Sweden.
SKB R-99-68, Svensk Kärnbränslehantering AB
- Brunberg A K, Blomqvist P, 2000.** Post-glacial, land rise-induced formation and development of lakes in the Forsmark area, central Sweden.
SKB TR-00-02, Svensk Kärnbränslehantering AB
- Brydsten L, 1999.** Change in coastal sedimentation conditions due to positive shore displacement in Öregrundsgrepen.
SKB- TR-99-37, Svensk Kärnbränslehantering AB
- Brydsten L, 1999.** Shore level displacement in Öregrundsgrepen.
SKB TR-99-16, Svensk Kärnbränslehantering AB
- Engqvist A, Andrejev O, 1999.** Water exchange of Öregrundsgrepen – A baroclinic 3d-model study.
SKB TR-99-11, Svensk Kärnbränslehantering AB
- Engqvist A, Andrejev O, 2000.** Sensitivity analysis with regard to variations of physical forcing including two hydrographic scenarios for the Öregrundsgrepen – A follow-up baroclinic 3D-model study.
SKB TR-00-01, Svensk Kärnbränslehantering AB
- Jerling L, Isaeus M, Lanneck J, Lindborg T, Schüldt R, 2001.** The terrestrial biosphere in the SFR region.
SKB R-01-09, Svensk Kärnbränslehantering AB
- Karlsson S, Bergström U, Meili M, 2001.** Models for dose assessments. Models adapted to the SFR-area, Sweden.
SKB TR-01-04, Svensk Kärnbränslehantering AB
- Kautsky H, Plantman P, Borgiel M, 1999.** Quantitative distribution of aquatic plant and animal communities in the Forsmark area.
SKB R-99-69, Svensk Kärnbränslehantering AB
- Kumblad L, 1999.** A carbon budget for the aquatic ecosystem above SFR in Öregrundsgrepen.
SKB R-99-40, Svensk Kärnbränslehantering AB
- Kumblad L, 2001.** A transport and fate model of C-14 in a bay of the Baltic Sea at SFR.
SKB TR-01-15, Svensk Kärnbränslehantering AB
- Meili M, Holmberg P, Jonsson P, Persson J, in manus.** Characteristics, fluxes, and ¹³⁷Cs content of sediments along the Swedish coast of the Bothnian Sea.
- Sigurdsson T, 1987.** Bottenundersökning av ett område ovanför SFR, Forsmark.
SFR 87-07, Svensk Kärnbränslehantering AB

SKB, 2001. Project SAFE – Scenario and system analysis.
SKB R-01-13, Svensk Kärnbränslehantering AB

Spangenberg J, Eriksson S, 2000. Naturvärden i Forsmarksområdet. Sammanställning av befintliga inventeringar, planer och program samt en fältstudie.
SKB R-00-20, Svensk Kärnbränslehantering AB

Westman P, Wastegård S, Schoning K, Gustafsson B, Omstedt A, 1999. Salinity change in the Baltic Sea during the last 8,500 years: evidence, causes and models.
SKB TR-99-38, Svensk Kärnbränslehantering AB

2 Biosphere matrix

In the SAFE project considerable effort has been put into the description of the biosphere processes and their interactions in an interaction matrix. The details are presented in /SKB, 2001/ together with the repository matrix and the geosphere matrix. The matrix will be further updated to provide general interaction matrix for the biosphere. Experts from different disciplines have participated in the work, many of them were also engaged in the other studies presented in this report. In the following sections, a short description of the elements and processes is presented. In the report /SKB, 2001/ the relevance of the processes for the safety assessment are evaluated.

2.1 Introduction

The biosphere matrix represents the surface environment in the repository area and should at least include:

- the parts of the surface environment with a potential impact on the repository,
- potential discharge areas and regions where any significant fraction of potentially released radionuclides may accumulate in significant concentrations.

The biosphere matrix is shown in Figure 2-1. It displays interactions (processes) between the different physical and biological components in the biosphere system, as well as interactions between the biosphere and geosphere systems and potential impacts from the surface environment outside the border of the biosphere system. Therefore, the geosphere and the external surface environment are included in the biosphere matrix as diagonal elements that represent different boundary conditions to the system.

A colour coding is used to display the priorities in the interaction matrices. In cases where an interaction box contains more than one interaction, the interaction with the highest priority determines the colour of the interaction box. The definition of the priorities used in the evaluation of the matrices is given in Table 2-1.

GEOSPHERE (B.C.)	a)Erosion/weath. b)Change in rock surface location	NONE	NONE	NONE	NONE	NONE	a)Material supply b)Settlement
a) Mech. load b) Consolidation	Quaternary deposits a)Relocation	a)Settlement b)Deposition	a)Settlement b)Consumption	a)Settlement b)Consumption	a)Settlement b)Consumption	a)Settlement b)Consumption	a)Settlement b)Consumption c)Material supply
Root penetration a) Rock b) Tunnels c) Biological	Root growth	Primary producers a)Stimul./Inhib.	a)Stimul./Inhib. b)Food supply	a)Stimul./Inhib. b)Food supply	a)Stimul./Inhib. b)Food supply	a)Stimul./Inhib.	a)Stimul./Inhib. b)Food supply d)Material supply
Potential intrusion	a)Decomposition b)Bioturbation	a)Stimul./Inhib.	Decomposers a)Stimul./Inhib. b)Food supply c)Feeding	a)Stimul./Inhib. b)Food supply	a)Stimul./Inhib. b)Food supply	a)Stimul./Inhib. b)Food supply	a)Stimul./Inhib. b)Food supply d)Material supply
Potential intrusion	Bioturbation	a)Stimul./Inhib. c)Feeding	a)Stimul./Inhib. b)Food supply c)Feeding	Filter feeders a)Stimul./Inhib. b)Food supply c)Feeding	a)Stimul./Inhib. c)Feeding	a)Stimul./Inhib. b)Food supply c)Feeding	a)Stimul./Inhib. b)Food supply d)Material supply
Potential intrusion	Bioturbation	a)Stimul./Inhib. c)Feeding	a)Stimul./Inhib. b)Food supply c)Feeding	a)Stimul./Inhib. b)Food supply	Herbivores a)Stimul./Inhib.	a)Stimul./Inhib. b)Food supply	a)Stimul./Inhib. b)Food supply d)Resource
Potential intrusion	Bioturbation	a)Stimul./Inhib.	a)Stimul./Inhib. b)Food supply c)Feeding	a)Stimul./Inhib. b)Food supply c)Feeding	a)Stimul./Inhib. c)Feeding	Carnivores a)Stimul./Inhib. b)Food supply c)Feeding	a)Stimul./Inhib. b)Food supply c)Feeding d)Resource
NONE	Disturbance (dredging, digging)	a)Stimul./Inhib. c)Feeding d)Dispersal/ Extermination	a)Stimul./Inhib. b)Food supply c)Feeding d)Dispersal/ Extermination	a)Stimul./Inhib. c)Feeding d)Dispersal/ Extermination	a)Stimul./Inhib. c)Feeding d)Dispersal/ Extermination	a)Stimul./Inhib. b)Food supply c)Feeding d)Dispersal/ Extermination e)Material use	Humans a)Stimul./Inhib.
a) Rech./disch. b) Press. change c) Mass flux d) Erosion/weath.	a)Erosion b)Water content change	a) Settlement b) Water uptake	a) Settlement b) Water uptake	NONE	a) Settlement b) Water uptake	a) Settlement b) Water uptake	a) Settlement b) Water use
a) Rech./disch. b) Press. change c) Mass flux d) Erosion/weath. e) Ice-load	Erosion (icescoring)	a)Settlement b)Relocation c)Water uptake	a)Settlement b)Relocation c)Water uptake	a)Settlement b)Relocation c)Water uptake	a)Settlement b)Relocation c)Water uptake	a)Settlement b)Relocation c)Water uptake	a)Settlement b)Relocation c)Water use
a) Mass flux b)Erosion/weath.	a) Sedimentation b) Precip./dissol. c) Erosion/weath.	a)Settlement b)Stimul./Inhib. c)Light attenu.	a)Settlement b)Stimul./Inhib.	a)Settlement b)Stimul./Inhib.	a)Settlement b)Stimul./Inhib.	a)Settlement b)Stimul./Inhib.	a)Settlement b)Stimul./Inhib.
Gas transport	a)Erosion b)Deposition c)Oxidation	a)Settlement b)Stimul./Inhib. c)Relocation d)Depos./Remov.	a)Settlement b)Stimul./Inhib. c)Relocation d)Depos./Remov.	NONE	a)Settlement b)Stimul./Inhib. c)Relocation d)Depos./Remov.	a)Settlement b)Stimul./Inhib. c)Relocation d)Depos./Remov.	a)Settlement b)Stimul./Inhib. c)Relocation d)Depos./Remov.
a)Heat transport b)Erosion/weath.	a)Weathering b)Thermal expands/contr	a)Settlement b)Stimul./Inhib.	a)Settlement b)Stimul./Inhib.	a)Settlement b)Stimul./Inhib.	a)Settlement b)Stimul./Inhib.	a)Settlement b)Stimul./Inhib.	a)Settlement b)Stimul./Inhib.
Contaminant transport	a) Surface dep./uptake b) Irradiation	a) Int. exposure b) Ext. exposure	a) Int. exposure b) Ext. exposure	a) Int. exposure b) Ext. exposure	a) Int. exposure b) Ext. exposure	a) Int. exposure b) Ext. exposure	a) Int. exposure b) Ext. exposure
NONE	a) Import b) Land rise	a) Import b) Insolation	Import	Import	Import	Import	a)Import of energy b)Immigration

Figure 2-1. The biosphere matrix /SKB, 2001/.

	Discharge/ recharge	Discharge/ recharge	Mass flux	Gas transport	Heat transport	Contaminant transport	NONE
	a) Water transport b) Dehydration	a)Water transport b)Wave formation	a)Resuspension b)Leaching c)Sorpt./desorpt.	a)Resuspension b)Non-biol decomp c)Wind field changes d)Air pressure	a)Radiation b)Heat transport c)Heat storage	a)Sorpt./desorpt. b)Dissolution	Export
	Root uptake	a)Interception b)Retard./Accel. c)Uptake/Excret. d)Covering	a)Uptake./Excret. b)Particle prod	a)Gas uptake/rel b)Part. trap/prod c)Wind retard.	a)Radiation b)Exo/Endo react. c)Heat transp.	a) Uptake/sorpt. b) Excretion c) Degradation d) Growth	Export <i>detached outflow of plankton</i>
	Decomposition	a)Decomposition b)Retard./Accel. c)Uptake/Excret. d)Movement	a)Uptake./Excret. b)Particle prod	a)Gas uptake/rel b)Part. trap/prod	a)Radiation b)Exo/Endo react. c)Heat transp.	a) Uptake/sorpt. b) Excretion c) Degradation d) Growth	Export
	NONE	a)Water-pumping b)Retard./Accel. c)Uptake/Excret.	a)Uptake./Excret. b)Particle prod	NONE	a)Radiation b)Exo/Endo react. c)Heat transp.	a) Uptake/sorpt. b) Excretion c) Degradation d) Growth	Export <i>detachment spawn</i>
	NONE	a)Movement b)Retard./Accel. c)Uptake/Excret.	a)Uptake./Excret. b)Particle prod	a)Gas uptake/rel b)Part. trap/prod	a)Radiation b)Exo/Endo react. c)Heat transp.	a) Uptake/sorpt. b) Excretion c) Degradation d) Growth	Export
	NONE	a)Movement b)Retard./Accel. c)Uptake/Excret.	a)Uptake./Excret. b)Particle prod	a)Gas uptake/rel b)Part. trap/prod	a)Radiation b)Exo/Endo react. c)Heat transp.	a) Uptake/sorpt. b) Excretion c) Degradation d) Growth	Export <i>swimming running</i>
	a)Water extraction b)Artific.infiltr.	a)Movement b)Retard./Accel. c)Uptake/Excret. d)Covering	a)Excretion b)Filtering c)Pollution	a)Gas uptake/rel b)Part. trap/prod c)Pollution d)Wind retard/acc.	a)Radiation b)Exo/Endo react. c)Heat transp. d)Antropogen eff	a) Uptake/sorpt. b) Excretion c) Degradation d) Growth	a)Export of energy b)Emigration?
NONE (former topography)							
	Water in quaternary deposits	Discharge (recharge)	a) Erosion b) Mixing c) Dens. effects	a)Evapo./Cond. b)Sublimation	a)Heat transp. b)Heat storage	Mixing	Export
	Recharge (discharge)	Surface water	a) Mixing b)Dens. effects	a)Evapo./Cond. b)Sublimation c)Erosion (seaspray/snowdrift)	a)Radiation b)Exo/Endo react. c)Heat transp. d)Heat storage e)Light reflection	Mixing	Export/import
	Water transport	Water transport	Water composition	a)Spray/Snowdrift b)Dissol./Degas.	a)Exo/Endo react. b)Light absorb. c)Light reflect./scatt. d)Adiab. compr.	a) Sorpt./desorpt. b) Dissol./precip. c) Sedimentation	Export
	a)Water transport b)Evapo./cond. c)Sublimation	a)Water transport b)Evapo./Cond. c)Precipitation d)Wind stress e)Sublimation	a)Precipitation b)Deposition c)Evapo./Cond. d)Dissol./Degas.	Gas Atmosphere	a)Radiation b)Exo/Endo react. c)Heat transp. d)Heat storage e)Adiab.temp.change f)Phase changes	a)Mixing b)Sorpt./desorpt. c)Photochem. reactions	Export
	Phase transitions	a)Phase transitions b)Convection	a)Kinetics & chem equil. b)Property changes c)Mixing	a)Pressure change b)Phase transitions	Temperature	a)Kinetics & chem equil. b)Phase transitions	Export of heat
	NONE	NONE	a) Radiolysis b) Stab. isotopes c) Chem. react.	Phase transition	Heat from decay	Radionuclides and toxicants a) Decay	Export
	Import	a) Sea level changes b) Sea currents	Import	a)Import b)Photochem-reactions	a) Import of heat b) Insolation	External load of contaminants	External conditions (B.C.)

Table 2-1. Definition of priorities used in the matrix.

Priority No.	Colour	Description
4	Pink	Important interaction only in the water saturation phase – part of the Safety Assessment. It can influence other parts of the process system included in this matrix, or other parts of the repository system not included in this matrix.
3	Red	Important interaction – part of the Safety Assessment. Could also influence other parts of the process system (defined in this matrix), or other parts of the repository system. The interaction can be either a prerequisite for the PA or handled by assumptions or modelling efforts in the PA.
2	Yellow	Interaction present – probably part of the Safety Assessment. Limited or uncertain influence directly via this interaction on other parts of the process system, or other parts of the repository system. However, this interaction can be the main focus of other matrices.
1	Green	Interaction present – does not have to be considered in the Safety Assessment. Negligible influence on other parts of the process system, (defined in this matrix) and other parts of the repository system.
0	White	No identified interactions.

2.2 Diagonal elements – system state variables

The physical and biological components of the biosphere system are (see Table 2-2):

- Quaternary deposits.
- Solid rock at the surface, outcrops.
- Buildings and structures such as roads, embankments, bridges.
- Vegetation.
- Animals.
- Humans.
- Water.
- Gas and atmosphere.

Element 1.1 covers the biosphere interaction with the SFR-1. It has been assumed that all such interactions occur through the geosphere/biosphere interface. Quaternary deposits, surface rock and buildings and other solid structures at the surface are included in element 2.2. Elements 3.3 to 8.8 cover the biological life, defined according to their trophic level in the food-web. The interface between solid, physical components in the biosphere and water or air is defined as the topography and was originally included as a separate element, 9.9. However, it was later found that it was more appropriate to include topography in element 2.2, Quaternary deposits, since it concerns the geometry of quaternary deposits. In order to avoid the extra work of renumbering all interactions in the matrix, the diagonal element 9.9 is left as an empty element in the matrix.

Elements 10.10 to 12.12 take care of the water in the biosphere, separated into the hydrology in quaternary deposits, 10.10, the hydrology of open surface waters in terms of sea, bays, lakes, rivers etc., 11.11, and the composition of the water in the quaternary deposits and surface waters, 12.12. Element 13.13 refers to the properties of gas in the physical components as well as to the atmosphere in the area and element 14.14 covers the temperature conditions in all physical components. Elements 9.9 to 14.14 cover the different physical transport-related conditions in the biosphere. As in the other matrices, radionuclides and toxins in all components of the biosphere are included in a separate diagonal element, 15.15. Element 16.16 includes all external conditions that can influence the local properties and conditions included in the biosphere matrix.

Table 2-2. Definition of the diagonal elements in the biosphere matrix.

Element name	Short description	Variables
1.1 Geosphere (Boundary condition)	The physical components in the geosphere that via interactions can affect and be affected by properties and conditions in the components of the biosphere, i.e. rock, backfill in tunnels and bore holes and ventilation shafts, plugs, water and gas	Those variables assigned to diagonal elements 5.5, 6.6, 9.9, 10.10, 11.11, 12.12, 13.13, 14.14, 15.15 and 16.16 in the geosphere matrix
2.2 Quaternary deposits	Loose deposits including recent materials (e.g. soil, fine grain sediments, large grain sediments and till) and surface rock (out crops). In addition, buildings and structures such as roads, road-banks, bridges and houses are included Interface between rock or sediments and air, and rock or sediments and surface waters	Amount, depth, location, spatial distribution, grain size distribution, pore- and fracture characteristics, composition, mineralogy, surface characteristics Baseline topography, e.g. land and bottom contours
3.3 Primary producers	Primary producers of organic matter (plants, algae, trees etc.). Particles and solids deposited on surfaces of primary producers are also included	Type and amount Location and size
4.4 Decomposers	Bacteria, worms, snails, fungi etc. that decompose dead organic matter. The decomposers live usually in the Quaternary deposits. Particles and solids deposited on surfaces of the decomposers are also included	Number of humans living at different places Behaviour, e.g. living habits, culture, technical development etc.
5.5 Filter feeders	Mussels, hydroids, sponges, insect larvae etc. that filter water. Filter feeders are living on rock surfaces and on loose deposits in water	Rate of growth and life time Radiologic and toxic effects
6.6 Herbivores	Plant eaters (e.g. snails, insects, cow, sheep etc.) that live both on land and in water. Omnivores are included here and in 7.7, e.g. bear	
7.7 Carnivores	Animal eaters (e.g. fish, eagle, seal, fox, birds etc.) that live both on land and in water. Mosquitoes, parasites and ticks are also included. Omnivores are included here and in 6.6, e.g. bear	
8.8 Humans	All humans living in the affected area	
9.9 None	Comment: Originally topography that later was moved into 2.2	
10.10 Water in Quaternary deposits	The hydrology in Quaternary deposits in terms of the pore water flow characteristics in the unsaturated zone and the groundwater flow characteristics in the saturated zone. The physical state of the water is also included, i.e. water/frost/ice	Level of groundwater table, water content, degree of saturation, water pressure, magnitude, direction and distribution of water flow, quantity of water in different physical states, i.e. water/frost/ice
11.11 Surface water	All surface waters except water in Quaternary deposits, i.e. Öregrundsgrepen and other water recipients such as rivers, lakes etc. Rainwater on surface rock and "droplets" sorbed on other surfaces, e.g. primary producers are also included as well as snow and ice on land	Size, location, amount, pressure, wave lengths and velocities, water level, layering Magnitude, direction, distribution of water flow Amounts and movements of ice/snow on surfaces

Element name	Short description	Variables
13.13 Gas/ Atmosphere	All gases in the biosphere including the atmosphere in terms of composition and movement. Composition includes the content of particulate (e.g. ice crystals, water droplets, pollen, etc.)	Amount, pressure, movements, composition, particulate content and type, wind velocity, wind field
14.14 Temperature	Temperature in the physical components of the biosphere system	Temperature
15.15 Radio-nuclides and toxins	Radionuclides and toxins in all physical and biological components of the system 1) from the repository 2) background levels (e.g. from Chernobyl and the Forsmark Power plant)	Amount, type, chemical and physical form Concentration Location
16.16 External conditions (Boundary condition)	All external conditions that affect the local conditions that are considered in the biosphere matrix	Human behaviour, wind conditions, Large scale weather systems, Large scale water movements and water composition

2.3 Quaternary deposits

Quaternary deposits are defined as loose deposits including recent materials (e.g. soil, fine grain sediments, large grain sediments and till) and the surface of the rock. In addition, buildings and structures such as roads, embankments, bridges and houses are included in this element. The topography is also included and defined as the interface between rock or sediments and air, and rock or sediments and surface waters (bottom topography). The following interactions are potentially important for the defined characteristics (see Table 2-2) of the deposits.

2.3.1 Relocation

Quaternary deposits may be relocated through deposition and erosion, including landslides. The degree of relocation is influenced by the grain size and water content of the quaternary deposits and influences the height distribution of the topography. Erosion caused by buildings and structures (e.g. bridges) is also included. The natural processes of changes in topography due to relocation of quaternary deposits can be significant. However, the effects on topography resulting from land rise of rock will set the limits.

2.3.2 Bioturbation

The type and the amount of decomposers affect the physical properties and the chemical composition of the Quaternary deposits, e.g. by homogenisation of the upper layers. Bioturbation is important in the terrestrial environment when e.g. earthworms rework some soil. In lakes and in the Baltic Sea the decomposer fauna has a limited effect, at most the top few decimetres are affected.

2.3.3 Change in water content

The magnitude and direction of the water flow in the Quaternary deposits influences their water content, particularly whether the soil is saturated or not.

2.3.4 Erosion

The turnover of sediments is dependent on this process. The magnitude and direction of the surface water flow influences the magnitude of erosion and thereby the structure and porosity of Quaternary deposits, e.g. beach drift. Other examples of agents of erosion are frost and ice scouring.

2.3.5 Sedimentation

Sedimentation of particles from the water column may change the composition, geometry and porosity of the Quaternary deposits. The annual sediment accumulation will increase with time from about 0.5 mm/year to 1 cm/year in this area.

2.3.6 External boundary – land rise

Land rise, a result of the recovery from land-loading during the last ice-age, is still occurring /Påsse, 1997/. The land topography is a major driving force for the ground-water flow and is treated as a time-varying condition in the hydrogeological and ecosystem modelling.

2.4 Primary producers

Primary producers are defined as primary producers of organic matter, usually by photosynthesis (plants, algae, trees etc.). This element also includes particles and solids deposited on surfaces of the primary producers. The following interactions are potentially important for the defined characteristics (see Table 2-2) of the primary producers.

2.4.1 Settlement

The settlement of primary producers (location and type) is influenced by grain size, porosity and composition of Quaternary deposits and the roughness and structure of rock surfaces. Also the inclination and contours of the land is important in terms of sheltering effects and elevation. It is important for primary producers in water and land. In water, hard substrates (e.g. rock, gravel and stone) are important for many macroalgae to settle. Soft substrates (sediments) are important for rooted plants.

The amount of water in Quaternary deposits affects the settlement of primary producers. Too little or too much water prevents settlement. In the assessment this interaction is not addressed directly, since the water table is assumed to remain near the surface and be constant.

The availability and movement of open surface waters influence the settlement of primary producers and determine the vegetation structure. Important factors are water depth, amount, water currents etc.

The water composition (e.g. trace elements, nutrients, toxins, etc.) in Quaternary deposits and open surface waters affects the settlement of primary producers. Salinity and alkalinity are important factors affecting the settlement of plants in water and on land. In addition, turbidity is an important factor with respect to the colonisation of plants in water.

2.4.2 Feeding

The type and amount of filter feeders will affect the type, amount and location of plankton (primary producers) by eating them. The effect on primary producers can be large, but it is assumed that this is reflected in species composition. The amount of food the filter feeders eat determines the amount of contaminants that will be ingested and is, therefore, important for the filter feeders. The transfer of food is included in the ecosystem models.

2.4.3 Stimulation/inhibition

The water composition (e.g. trace elements, nutrients, toxins, etc.) in Quaternary deposits and surface waters will affect the production of primary producers via stimulation/inhibition, thereby affecting the amount of primary producers living both in water and on land. Water droplets on land living producers are also included here.

Humans will also affect the type and amount of primary producers via cultivation, agriculture or selection, weeding, etc. This type of human activity e.g. in forests is important.

2.4.4 Water uptake

The amount of water in Quaternary deposits affects the water uptake and living conditions for primary producers and thus the type, amount and life-time of the primary producers in the area.

The surface water (including water on leaves) is a supply for the plants. The supply of waters will be important for irrigated plants where water will intercept with leaves and trunk. In water bodies plants will be well supplied with sufficient water. Root uptake by plants is from groundwater.

2.4.5 Light attenuation

The water composition (e.g. dissolved species and particulate matter) in surface waters influences the adsorption and distribution of light and thereby the type and productivity of primary producers. The process is also dependent on the location of primary producers (fixed on bottom surfaces or as plankton). Light attenuation sets the limits for how deep plants can grow in the sea and lakes.

2.4.6 Insolation

The extent of solar irradiation influences photosynthesis and thereby the type and amount of primary producers. This determines the rate of carbon fixation and is the driving mechanism in the ecosystem model.

2.4.7 Exposure

Concentration, location and type of radionuclides and other toxins in primary producers affect the internal exposure and the radiological and toxic effects on the primary producers. In addition, the concentration, location and type of radionuclides in surface waters, quaternary deposits and in the atmosphere, i.e. in all parts of the biosphere system, affect the external exposure and the radiological and toxic effects on the primary producers.

2.4.8 Import and export

Outflow/export of primary producers from the system can occur via e.g. detachment of macroalgae, timbering, and harvesting of hay, grass, vegetables that are transported from the area. In aquatic systems, the continuous outflow of pelagic organisms can be considerable. In terrestrial systems, the export is more occasional, e.g. timber.

2.5 Decomposers

Decomposers are defined as bacteria, worms, snails, fungi etc. that decompose dead organic matter. The decomposers usually live in the quaternary deposits. This element also includes particles and solids deposited on the surfaces of the decomposers. The following interactions are potentially important for the defined characteristics (see Table 2-2) of the decomposers.

2.5.1 Settlement

The settlement of decomposers (location and type) is influenced by location, grain size and chemical composition of Quaternary deposits and the location and mineralogy of rock surfaces (substrates). Most macroscopic decomposers (e.g. worms) prefer soft substrates (e.g. sand, clay, mud, and soils). Microscopic organisms (e.g. bacteria) are dependent on the surface area. The water composition (e.g. salinity and alkalinity, dissolved and particulate organic matter (DOM and POM)) also has a large effect on decomposers.

2.5.2 Consumption

Consumption of sediments or soils may occur accidentally with the food or on purpose. This is a normal process for many macro-decomposer.

2.5.3 Food supply

The type and amount of primary producers affect the type and amount of decomposers by acting as their food supply. Examples of processes influencing the food supply are detachment and sedimentation of e.g. leaves and needles. Herbivores and carnivores also supply food to decomposers as a result of debris production (faeces, mechanical fragmentation, horns, fur, feathers) and mortality (the mortality rate influences the supply of dead matter).

2.5.4 Feeding

The feeding of pelagic decomposers (e.g. bacteria) is an important pathway. However, filter feeders have a low abundance in the SFR area. The consumption of mushrooms by herbivores and its impact on the amount of mushrooms in the area is important since mushrooms are part of an important pathway for exposure.

2.5.5 Stimulation/inhibition

The temperature will affect the metabolism of decomposers.

2.5.6 Water uptake

The amount of water in Quaternary deposits affects the water uptake by decomposers and their living conditions, thereby determining the type, amount and life-time of decomposers in the area.

2.5.7 Exposure

The concentration, location and type of radionuclides and other toxins in decomposers affect the internal exposure and the radiological and toxic effects on the decomposers. The concentration, location and type of radionuclides in surface waters, quaternary deposits and in the atmosphere, i.e. in all parts of the biosphere system, affect the external exposure and the radiological and toxic effects on the decomposers.

2.6 Filter feeders

Filter feeders are mussels, hydroids, sponges, insect larvae etc. that filter water. Filter feeders are normally attached to rock surfaces and on loose deposits, including recent materials. The following interactions are potentially important for the defined characteristics (see Table 2-2) of the filter feeders.

2.6.1 Settlement

The settlement (location and type) of filter feeders is influenced by location, grain size distribution of sediments and the location and roughness of rock surfaces (substrates). Hard substrates are good settling areas for many filter feeders (e.g. blue mussels, zebra

mussels, hydroids, and sponges), while a few filter feeders prefer soft substrates (e.g. insect larvae).

Filter feeders are also dependent on permanent or diurnal submergence in water, and on the water composition, especially the salinity of the water. Thus, the species composition reflects the position of the water-bodies and their composition.

2.6.2 Stimulation/inhibition

The composition of surface waters will stimulate or inhibit the production of filter feeders. The amount of particles in the water is important, since particle uptake determines the uptake of contaminants sorbed to particles. The particle content in the water is assumed or estimated in the assessment. Temperature will affect the metabolism of filter feeders.

2.6.3 Exposure

The concentration, location and type of radionuclides and other toxins in filter feeders affect the internal exposure and the radiological and toxic effects on the filter feeders. In addition, the concentration, location and type of radionuclides in surface waters, quaternary deposits and in the atmosphere, i.e. in all parts of the biosphere system, affect the external exposure and the radiological and toxic effects on the filter feeders.

2.7 Herbivores

Herbivores are defined as plant eaters (e.g. snails, insects, cow, sheep). Herbivores live both on land and in water. Omnivores are included here, as well as under carnivores. The following interactions are potentially important for the defined characteristics (see Table 2-2) of herbivores.

2.7.1 Settlement

The settlement of herbivores (location and type) is influenced by location and type of quaternary deposits in that they determine the food resources available for herbivores (i.e. plants). In addition, some species need special locations for nests, e.g. a suitable substrate. Some herbivores live in water some other on land. Thus, the settlement of herbivores is also dependent on the existence of water. Also the water composition (e.g. salinity, trace elements, toxins, etc.) in quaternary deposits and surface waters affects the settlement of herbivores.

2.7.2 Consumption

Herbivores may consume solid material accidentally with their food. This is an important pathway for herbivores consuming plants.

2.7.3 Food supply

The amount of primary producers and supply rate, i.e. the food supply, set the upper limit for what food intake of the population can be.

2.7.4 Stimulation/inhibition

The quality of the food supply stimulates/inhibits the production of herbivores. The turnover of biomass by herbivores is an important part of the organic matter flow through the biological community. The cultivation and selection of domestic animals by humans is evidently important for the stimulation/inhibition of such species. Temperature will affect the metabolism of poikilothermic herbivores.

2.7.5 Water uptake

Herbivores need large quantities of water and can be limited by the supply of water. Water is important as a carrier of contaminants.

2.7.6 Exposure

The concentration, location and type of radionuclides and other toxins in herbivores affect the internal exposure and the radiological and toxic effects on the herbivores. The concentration, location and type of radionuclides in surface waters, quaternary deposits and in the atmosphere, i.e. in all parts of the biosphere system, affect the external exposure and the radiological and toxic effects on the herbivores.

2.8 Carnivores

Carnivores are defined as animal eaters or predators (e.g. fish, eagle, seal, fox, and birds). Omnivores are included here, as well as with herbivores. This element also includes mosquitoes, parasites and ticks. The following interactions are potentially important for the defined characteristics (see Table 2-2) of the carnivores.

2.8.1 Settlement

The settlement (location and type) of carnivores is influenced by location and properties of the quaternary deposits and by the location and properties of rock surfaces. These factors affect mainly the habitat and thus the occurrence of certain species. However, the major pathway for radionuclides will be determined by the species of a carnivore prey and how the prey is dependent on the substrate.

Carnivores live in water (e.g. fish) or on land (e.g. fox). Thus, the settlement of carnivores is also dependent on the existence of surface water and on the water composition.

2.8.2 Food supply and feeding

Decomposers can be an important food source for carnivores and the supply of decomposers can limit the carnivore population. The supply is also a pathway for contamination. The consumption of herbivores is an important pathway for ingestion of contaminants by carnivores. Carnivores can also eat other (species) of carnivores.

2.8.3 Stimulation/inhibition

The temperature will affect the metabolism of poikilothermic carnivores.

2.8.4 Exposure

The concentration, location and type of radionuclides and other toxins in carnivores affect the internal exposure and the radiological and toxic effects on the carnivores. In addition, the concentration, location and type of radionuclides in surface waters, quaternary deposits and in the atmosphere, i.e. in all parts of the biosphere system, affect the external exposure and the radiological and toxic effects on the carnivores.

2.9 Humans

The following interactions are judged to be important regarding the settlement and habits of humans in the area.

2.9.1 Settlement – living and building

The availability of quaternary deposits as a building material may affect settlement. In addition, the type of construction, the construction method and the location of the buildings are influenced by the physical properties of the materials used. The size and location of surface waters affects the settlement of humans in the area. The place where humans settle is important with respect to their exposure to gas and external radiation.

2.9.2 Food supply

The existence and supply of seed, herbs and roots for eating is essential for the intake of radionuclides. The supply of filter feeders, i.e. mussels, oysters etc., is usually not a limiting factor for humans, but the existence of these products and amount of supply is important to the intake of radionuclides. In the SFR- area the production of edible filter feeders is limited. Consumption of animals, cows, sheep etc., is an important pathway for ingestion of contaminants. Carnivorous seafood (shellfish and fish) are the only carnivores normally consumed by man. It is unusual to eat carnivorous terrestrial animals. The supply rate does not limit humans, but the contents of contaminants are important with respect to the total contaminant intake.

2.9.3 Material supply

The use of different materials in building or furniture can give rise to external exposure. The burning of wood gives ashes, which may contain high amounts of radionuclides. However, in most cases the external exposure is very small.

2.9.4 Water use

The amount of accessible water in quaternary deposits affects the way and how much of the water is used by humans living in the area, e.g. how much of the water is used as drinking water and for bathing, washing etc. Humans use water for many different purposes.

2.9.5 Stimulation/inhibition

The water composition (e.g. trace elements, toxins, etc.) in Quaternary deposits and surface waters can affect the stimulation/inhibition of humans. Human behaviour especially is affected (drinking water, swimming etc.) by the water composition.

2.9.6 Exposure

The concentration, location and type of radionuclides and other toxins in humans affect the internal exposure and the radiological and toxic effects on humans. Assessing these affects is one of the main endpoints of the safety assessment. The concentration, location and type of radionuclides in surface waters, quaternary deposits and in the atmosphere, i.e. in all parts of the biosphere system, affect the external exposure and the radiological and toxic effects on humans. External exposure could be small compared to internal exposure, but is certainly included in the assessment.

2.10 Water in quaternary deposits

This element is defined as the hydrology of the quaternary deposits. It includes the pore water flow characteristics in the unsaturated zone and the groundwater flow characteristics in the saturated zone (see Table 2-2). The following interactions are judged to be potentially important.

2.10.1 Water transport

The magnitude and distribution of the water flow in the quaternary deposits is influenced by the hydraulic conductivity and storage capacity (porosity) of these deposits and by the topography. Changes in the upper layer properties may occur as a result of natural processes or human actions, e.g. asphalt. The atmospheric pressure and the pressure of existing gas will affect the location of the groundwater table and thus also the water content and the water movement in the quaternary deposits.

2.10.2 Recharge/discharge

Infiltration and percolation of surface waters into the quaternary deposits will affect the hydraulic situation as well as the dilution.

2.10.3 Evaporation/condensation

Evaporation of water and condensation of water vapour in quaternary deposits will change the water content. The atmospheric conditions, e.g. pressure, humidity and content of particles will influence the degree of evaporation/condensation. The processes are included in the precipitation and runoff calculations.

2.10.4 Water extraction

Extraction of water by humans, e.g. from wells, may affect the water flow and water content in the Quaternary deposits.

2.10.5 External boundary conditions – import

The inflow of water to quaternary deposits within the defined system from quaternary deposits outside the defined system needs to be considered.

2.11 Surface water

This element is defined as all surface waters (i.e. not the water in quaternary deposits). It includes the Öregrundsgrepen and other water recipients such as rivers, lakes etc. and also rainwater on surface rock, “droplets” sorbed on other surfaces and snow on land. The following interactions are judged to be potentially important.

2.11.1 Discharge/recharge

Discharge of water in Quaternary deposits to surface waters and the recharge of water in the Quaternary deposits by surface waters is important for the contaminant transport from groundwater to surface water.

2.11.2 Water transport and convection

The topography determines the gravitational flow and influences thereby the amount of water infiltrating and the run off to surface waters. The topography determines the location and size of water reservoirs both on land and in the surface waters and influences thereby the water exchange. In addition, the topography can lead to choking of the water flow, resulting in higher water velocities.

The composition of surface waters will affect the density and viscosity of the water, which in turn will affect the magnitude, distribution and direction of surface water movements and the stratification of the water. The stratification and turnover water in lakes and the sea are dependent on the water density (salinity and temperature).

Atmospheric pressure will affect the location of the sea water level, affecting in turn the water turnover. Atmospheric pressure is also considered in the oceanographic model.

2.11.3 Wind stress and wave formation

The bottom topography determines the water depth and thereby influences the height of the waves. The strength and direction of the wind will affect the movement of surface waters, e.g. wave formation. In addition, the wind will influence the amount of water droplets and snow particles that are released to the atmosphere and thus the amounts of surface waters and amounts of snow/ice on surfaces.

2.11.4 Movement – human induced

The movement of humans (e.g. swimming) in surface waters may have an influence on the surface water movement. In addition, other human activities e.g. large-scale export, piping, wave generation, etc. will have an influence on the amount and movement of surface waters.

Uptake of surface water by humans for consumption can influence the amount and movement of surface waters. This is an important exposure pathway for humans and can affect a water body.

2.11.5 Evaporation/condensation

Evaporation of surface waters and condensation of humidity will have an influence on the volumes of surface waters. The atmospheric conditions, e.g. pressure, humidity and particles content will influence the processes of evaporation and condensation, which are included in precipitation and runoff calculations.

2.11.6 Precipitation

The magnitude of the precipitation, e.g. rainfall, snow and hail, will influence the surface water volume and the amounts of ice/snow on surfaces. Together with evaporation, precipitation also determines the amount available for groundwater recharge, though it is usually not the limiting factor.

2.11.7 External boundary conditions – sea currents

Ekman transport occurs as a result of the wind fields and the rotation of the earth. Coriolis forces give rise to water movement at right angles to the wind direction. Ekman transport is one of the driving forces for water turnover of the sea.

2.11.8 External boundary conditions – sea level changes

Sea level changes will affect the volumes and movement of surface waters. Sea level changes can be caused by e.g. earth quakes (tsunamis), clathrates, global heating, land slides, earth tides, weather and climatic changes. For SFR, the only sea-level changes considered are those due to the ongoing land-rise and the potential impact of the climate.

2.12 Water composition

This matrix element concerns the composition of water in Quaternary deposits and surface waters, including the composition of snow. The following interactions are potentially important for the defined characteristics (see Table 2-2) of the water composition.

2.12.1 Boundary condition – mass flux

Transport of groundwater components will affect the composition of water in quaternary deposits and surface waters.

2.12.2 Re-suspension

The size distribution of the particles in the quaternary deposits influences the amount of material re-suspended in the water and thereby the particulate content in the water. Re-suspension is an important process of transfer from sediments to water. It also determines where there will be soft bottoms in the future.

2.12.3 Uptake/excretion

The type and amount of primary producers and decomposers influence the water composition by uptake and excretion, for example the uptake of nutrients and CO₂ (by primary producers) or O₂ (by decomposers) and the excretion of O₂ (by primary producers) or CO₂ (by decomposers) and dissolved organic species. In addition, the uptake of pure water by organisms can lead to increased concentrations of dissolved salts and nutrients in the water.

2.12.4 Particle production and trapping

The existence of decomposers in surface waters gives rise to particle production. The type and amount of decomposers will thus influence the water composition. Decomposers such as bacteria are an indistinguishable part of the organic particle content in water. Larger decomposers also produce particles due to sloppy feeding or bioturbation, which affects the particle content in water.

2.12.5 Mixing

The magnitude, direction and distribution of surface water flow will affect the mixing of the water and thereby also the composition of the water. Mixing is an important process for dilution and substitution of particulate matter.

2.12.6 Property changes

Temperature affects the density and viscosity of water and is therefore the driving force for the turnover of water.

2.12.7 External boundary condition – import

The composition of the surrounding waters outside the system will, when water import occurs, affect the composition of the surface waters and the water in the quaternary deposits.

2.13 Gas – atmosphere

Gas is defined as all the gases in the biosphere including gas in pores and in the atmosphere. Both gas composition and gas flow are included in this element. The gas composition includes the content of particles (e.g. ice crystals, water droplets, pollen, etc.). This element also includes atmospheric flow and wind. The following interactions are judged to be potentially important.

2.13.1 Boundary condition – gas transport

The transport and release of gas from the geosphere will influence the amount and composition of gas in the biosphere. The supply of gas from the repository and the geosphere has no influence on surface waters, but may be of importance locally in the atmosphere. The turnover velocities influence the importance. Examples of gases released from the geosphere are; H₂, CO₂, CH₄, Rn and H₂S.

2.13.2 Re-suspension

The grain size distribution in the quaternary deposits influences the amount of material resuspended in the air and thereby the particle content of the air. Resuspension of particles is important for the formation of dust in air.

2.13.3 Particle production – trapping

Humans can generate particles, for example by ploughing.

2.13.4 External boundaries – import

The global wind directions, magnitudes and atmospheric composition affect the gas element in the studied system. Wind velocity and wind direction are important parameters with respect to water turnover and shore erosion in the sea and lakes.

2.14 Temperature

The following interactions are judged to be potentially important for the temperature in the quaternary deposits, in the surface waters and in the atmosphere.

2.14.1 Heat storage

The volumes and thermal properties of surface waters affect the heat storage capacity and thus the temperature in the surface waters. Heat storage drives convective circulation in the water bodies.

2.14.2 Heat driven convection

Heat driven convection affects the temperature stratification (and vices versa).

2.14.3 Light absorption

The particles content of surface waters will affect light absorption and thus the temperature in surface waters. Light absorption is an important process responsible for the thermal stratification of surface waters.

2.14.4 External boundaries – import of heat

Import of heat by different materials (wind, water etc.) entering the system will influence the temperature in the different components of the studied system.

2.15 Radionuclides and toxins

Radionuclides and toxins refer to all the radionuclides in all the biosphere components, including both those potentially released from the repository as well as background levels (e.g. from Chernobyl and the Forsmark Power plant). The following interactions are judged to be important.

2.15.1 Boundary condition – release from the geosphere

The release of radionuclides and other toxins in the water and gas phases from the geosphere affects the transport of radionuclides and toxins in aqueous and gaseous form in the biosphere. It is the source term for migration of radionuclides and toxins in the biosphere.

2.15.2 Sorption/desorption

The distribution of radionuclides and toxins between the solid phase and the aqueous phase is influenced by the composition and grain size distribution (available surfaces for sorption) of Quaternary deposits and by the mineralogy and porosity of the surface rock as well as on the water chemistry.

The particles in the water in the different parts of the biosphere system also affect the sorption/desorption of radionuclides and other toxins. This affects the concentration of radionuclides and toxins in the water and on the solid phases in the different parts of the biosphere system.

2.15.3 Sorption/uptake and excretion

The uptake of radionuclides and other toxins by primary producers, decomposers, filter feeders, herbivores and carnivores affects the concentration of radionuclides and other toxins in these organisms as well as in other components of the biosphere system. Accumulation in organisms is the net effect of uptake and excretion. Excretion is assumed to be less than uptake.

The uptake of radionuclides and other toxins by humans affects the concentration of radionuclides and other toxins in humans as well as in other components of the biosphere system. Accumulation in humans is the net effect of uptake and excretion and is important for the estimates of dose.

2.15.4 Degradation

Degradation of non-radiological toxins by the biological components of the system affects the type and concentration of toxins in the different parts of the biosphere system.

2.15.5 Growth

The rate of growth of the biological components of the system affects the concentration of radionuclides and other toxins in them.

2.15.6 Mixing

The distribution, magnitude and direction of water flow in quaternary deposits affect the concentration of radionuclides and other toxins in the water by mixing.

Also the characteristics of surface water flow affect the concentration of radionuclides and other toxins in the water by mixing. Mixing and dilution are important processes for radionuclide transport.

2.15.7 Phase transitions

The distribution of radionuclides and toxins between different phases (solid, liquid, gas) is influenced by the temperature.

2.15.8 Decay

Radionuclide decay is evidently important and considered in the models.

2.15.9 External boundaries – export

Radionuclides will be transported out from the local system, e.g. by moving water, which will affect the concentration of radionuclides in the local system.

2.16 Reference

Påsse T, 1997. A mathematical model of past, present and future shore level displacement in Fennoscandia.

SKB TR 97-28, Svensk Kärnbränslehantering AB

SKB, 2001. Project SAFE – Scenario and system analysis.

SKB R-01-13, Svensk Kärnbränslehantering AB

3 Climate

3.1 Today

A brief description of the climate of the SFR site has been given by /Jerling et al., 2001/, see Table 3-1 and Figure 3-1 below.

The SFR site is located in the snow climates (Dfb) according to the Köppen classification system. Dfb is the dominating climate zone in Sweden and in north-east Europe. Since the SFR is located at the coast, the Baltic Sea has an equalising effect on the climate and the climate is more humid here than further inland. The Dfb climate zone indicates that the coldest month's temperature in average is under 3°C and the warmest month is above 10°C. Precipitation is adequate in all months.

The year 1992 was selected by /Engqvist and Andrejev, 1999/ to be the year from which meteorological data should be taken in their modelling study of water turnover. The mean air temperature in 1992 measured at Örskär meteorological station was 1.4°C higher than the mean of 1961–1990. This was caused mainly by higher temperatures than normal in May and June, which also showed in the water temperature. The winter 91/92 was rather mild and the ice cover was slow to develop.

Table 3-1. Climatic characteristics of the SFR area.

Mean annual temperature	+5.5°C
Mean temperature of the coldest month	-4°C (February)
Mean temperature of the warmest months	+15°C (July–August)
Mean annual precipitation	563 mm/year *
Highest measured precipitation	80 mm/month (July–August)
Mean annual run off	200–300 mm/year
Mean durability of snow cover	110 days
Average snow depth	20 cm
Vegetation period	160–180 days (May–November)
Frostperiods during growing period	10–20 days
Mean sunshine duration/year	2000 hours
Mean global radiation during June	180–190 kWh/m ²

* from /Lindell et al., 1999/

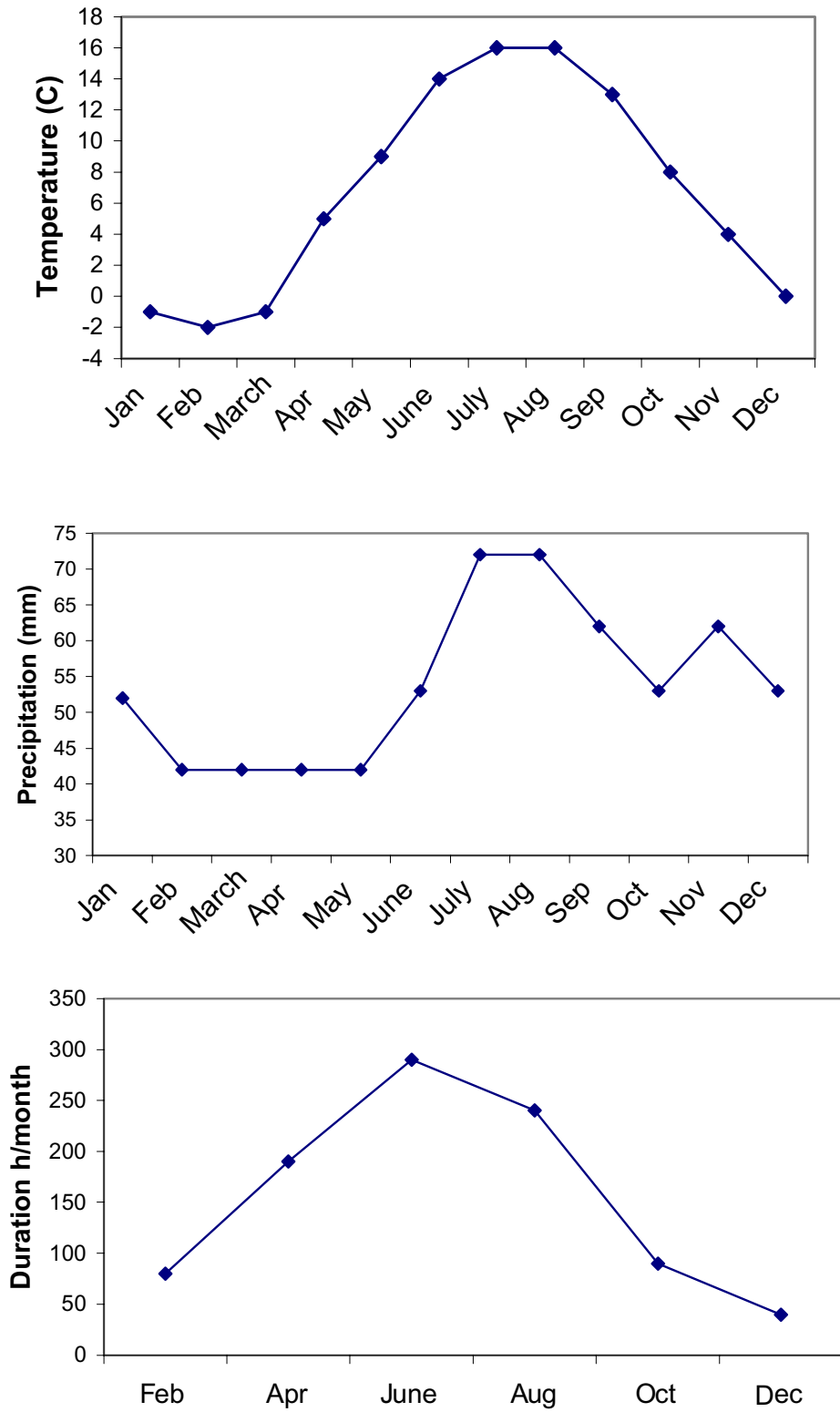

Figure 3-1. Monthly mean temperature (a), precipitation (b) and solar duration (c) in the SFR region from /Jerling et al., 2001/.

3.2 Future development, general

Short term changes in climate are difficult to predict. A large part of the expected climatic change, e.g. change due to the greenhouse effect, falls within the range of between-year variation. The most persistent and dramatic change is expected to be the next ice age /Boulton et al., 1999; SKB, 1999/. Earlier SKB studies have shown that a colder climate can reasonably be expected in about 5,000 years, i.e. 7,000 AD. The colder climate will also result in a decreased precipitation. Evapotranspiration will also be reduced. There is a possibility that permafrost will develop.

3.3 References

Boulton G S, Kautsky U, Morén L, Wallroth T, 1999. Impact of long-term climate change on a deep geological repository for spent nuclear fuel. SKB TR-99-05, Svensk Kärnbränslehantering AB

Engqvist A, Andrejev O, 1999. Water exchange of Öregrundsgrepen – baroclinic 3d-model study. SKB TR 99-11, Svensk Kärnbränslehantering AB

Jerling L, Isaeus M, Lanneck J, Lindborg T, Schüldt R, 2001. The terrestrial biosphere in the SFR region. SKB R-01-09, Svensk Kärnbränslehantering AB

Lindell S, Ambjörn C, Juhlin B, Larsson-McCann S, Lindquist K, 1999. Available climatological and oceanographical data for site investigations of surface ecosystems. SKB-R-99-70, Svensk Kärnbränslehantering AB

SKB, 1999. Deep repository for spent fuel SR 97 – Post closure safety. Main Report volume I and II. SKB TR-99-06, Svensk Kärnbränslehantering AB

4 Study areas

In the SAFE study three sea areas are studied, the Baltic Sea, Öregrundsgrepen and the area local to the SFR repository. These areas are used in the modelling studies /Brydsten, 1999a; Engqvist and Andrejev, 1999, 2000; Jerling et al., 2001; Karlsson et al., 2001; Kumblad, 1999, 2001/. This section defines and briefly describes these study areas /Brydsten, 1999b/ and their hydrography /Engqvist and Andrejev, 1999; Westman et al., 1999/. Further discussions of the characteristics of these areas are given in the relevant sections.

4.1 Baltic Sea

The Baltic Sea is one of the largest brackish water seas in the world and came into existence after the ice age. The Baltic Sea is connected to the North Sea through two narrow straits with only 8 and 17 meters depth. The sea consists of a series of rather shallow basins, separated by sills. The area of the Baltic Sea is 377,400 km². The mean water depth has been estimated to 56 m (Figure 4-1).

The Baltic Sea is an enclosed sea. The parallel sills in the Danish sounds are very much shallower than both the average depth and the maximum depth. The river runoff plus precipitation strongly exceeds evaporation. The river runoff is rather accurately known; the average river discharge to the Baltic Sea during 1950–1990 was about 14,000 m³/s plus an additional 1,200 m³/s to the Belt Sea and Kattegat. /Westman et al., 1999/ estimated the flushing time of the Baltic under present climatic conditions to be about 20 years. The flushing time is defined as the volume of the Baltic Sea divided by the sum of all the annual inflows.

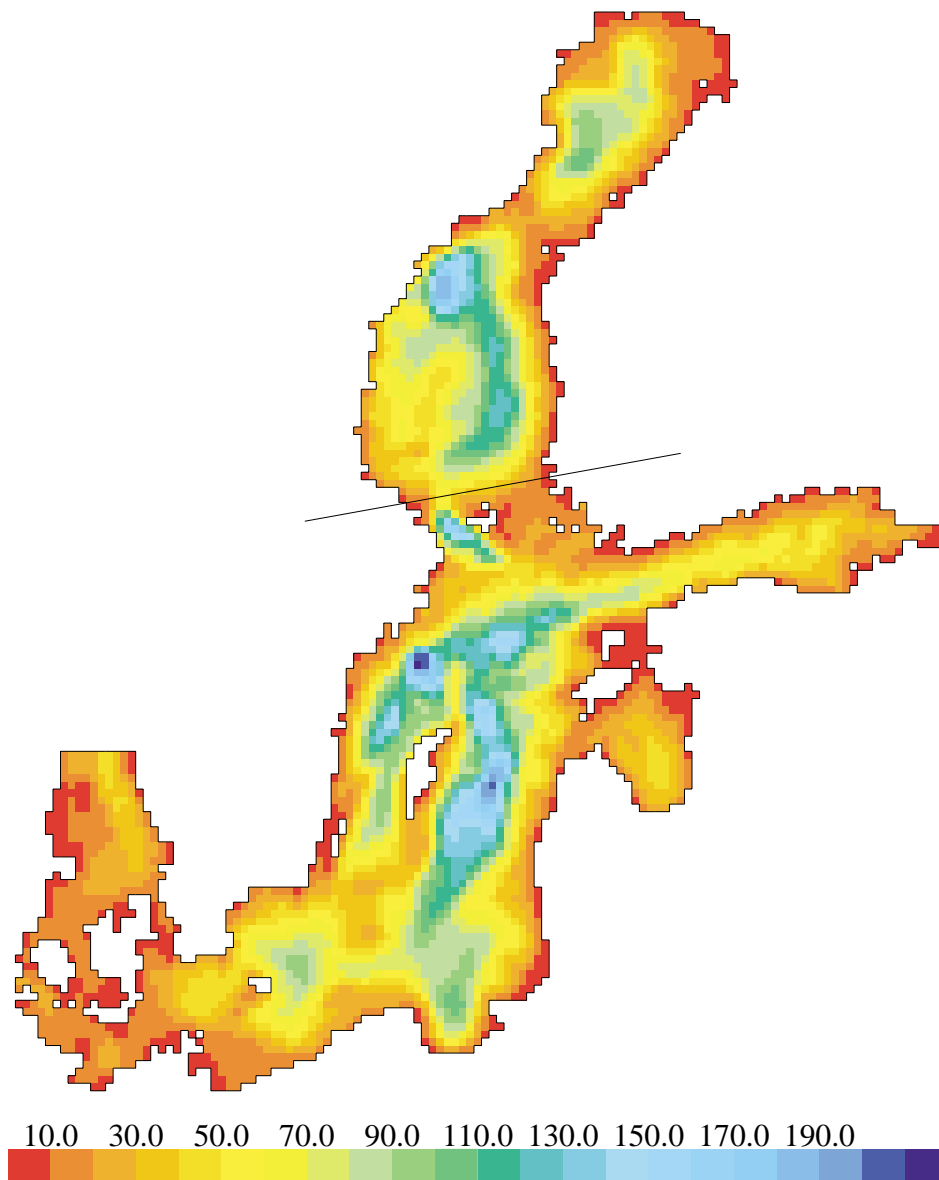

Figure 4-1. The Baltic hypsography. A line north of Åland indicates the position of a transect passing through the Öregrundsgrepen area /Engqvist and Andrejev, 1999/.

4.2 Öregrundsgrepen

Öregrundsgrepen (see Figure 4-2) is shaped like a funnel between the mainland and the islands Gräsö and Örskär, with its wide opening toward the Bothnian Sea in the North. In the south-eastern part there is a connection with the Åland Sea through a silled narrow strait at Öregrund. The western part of Öregrundsgrepen is a large shallow water area with many rocks and islands.

A 30 km long, deep channel stretches along Gräsö island from the deep sea in the north and through the Öregrund strait. The northern part of the channel runs in a north-south direction while the southern part is directed in a north-westerly direction. These two directions are the major tectonic structures in the area. The east side of the major

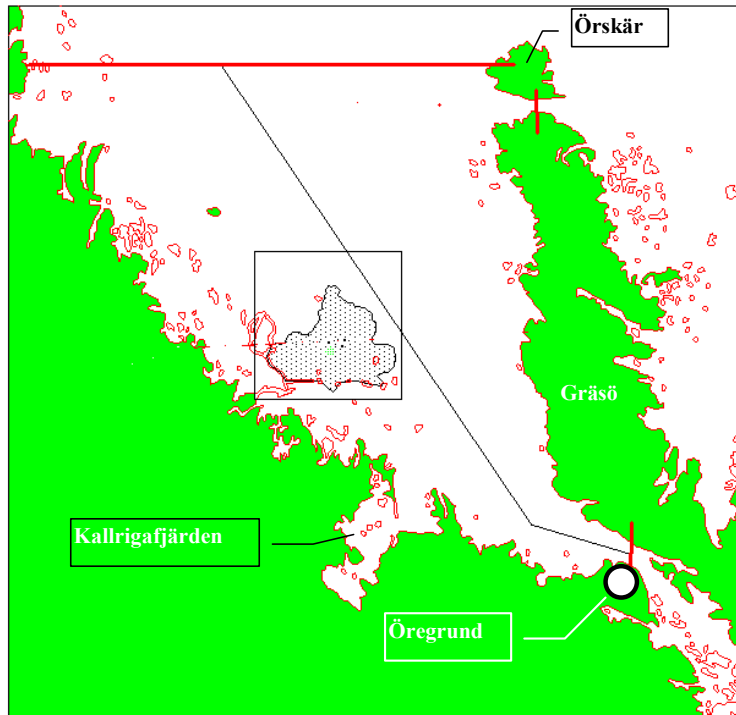

Figure 4-2. Map of Öregrundsgrepen (ÖG) with some local names indicated. The ÖG-model area is delimited by coarse lines /Engqvist and Andrejev, 1999/.

embayment has a deeper side east of a symmetry line with isolated depths exceeding 40 m, including the two deepest cavities in Öregrundsgrepen; Storgrunnan (51 meters) and a hollow to the west of the “Engelska Grundet” (59 meters). In the south the channel becomes increasingly shallow and has a depth of only 15 to 20 meters off the town of Öregrund.

The dominating directions of the currents in Öregrundsgrepen are southeast on the mainland side and north on the Gräsö side. The currents are mainly wind generated and coast-parallel.

The area of Öregrundsgrepen has been estimated to 456 km² and the mean water depth as 11.2 m calculated from /Brydsten, 1999a/.

4.2.1 Freshwater discharge

There are four streams that discharge freshwater into the area, but even the maximum monthly average flow of the largest one amounts merely to about 10 m³/s. The combined runoff of the streams in the area has been estimated to be 10 m³/s as average during a year. The two major streams discharge into the same minor embayment leading to a locally restricted effect by driving an estuarine circulation at the location of the discharge area. Since the amount of the water flushed across the boundaries is several orders of magnitude greater, see Chapter 7, the influence by these streams on the general circulation of the Öregrundsgrepen is small to the point of being negligible.

The addition of fresh water (precipitation–evaporation) on an area of about 400 km² amounts to about 10 m³/s (i.e. comparable to the run-off of the streams). This precipitation is however distributed over the entire Öregrundsgrepen, and is therefore also negligible compared to the inflow of water across the boundaries between Öregrundsgrepen and the Baltic. Therefor freshwater discharge has no influence on the water turnover in Öregrundsgrepen.

4.2.2 Ice dynamics

Ice formation occurs regularly and Öregrundsgrepen is ice-covered for about 100 days per year. On the average an ice cover forms the last week of December and melts by mid-April. During the model year 1992, ice formation began in the southern part at the end of January, reached its maximum extent northward at Engelska Grundet. All the ice was gone by the third week in March. An ice cover considerably reduces wind-mixing and provides an effective thermal insulation from the heat exchange with the atmosphere.

4.3 Local model area

The local model area, which is also shown in Figure 4-2 (above), is based on hydrological conditions /Brydsten, 1999b/ and corresponds to part of the catchment of the new lake (lake 4 in Figure 5-7 and Table 5-1) which will be formed to the north of SFR. The local model area is almost 11.5 km² of which at present 2.4% is land. This area has been adopted in the model of /Kumblad, 1999, 2001/, which represents the dynamics of carbon in the aquatic ecosystem, based on the description of aquatic plant and animal communities in /Kautsky et al., 1999/ (see Chapter 9). This area has also been adopted as the local area in the exposure models /Karlsson et al., 2001/. The mean water depth has been estimated to 9.5 m /Kumblad, 1999/.

The depth and volume of the different water layers in the local model area above SFR used in the modelling studies by /Engqvist and Andrejev, 1999/ are shown in the table below (Table 4-1).

/Kumblad, 1999/ has however adopted slightly different depth intervals in estimating the water layers and their volumes in modelling studies of carbon dynamics in the local model area. The values used by Kumblad for the present day and for 4,000 AD are given in the section 5.3.3.

Table 4-1. Hypsography of the gridded local model area.

Layer	Depth range	Thickness (m)	Volume (10 ⁶ m ³)
1	0 m–2.5 m	2.5	29.4
2	2.5 m–7.5 m	5	51.6
3	7.5 m–12.5 m	5	36.4
4	12.5 m–17.5 m	5	12.9

4.4 References

- Brydsten L, 1999a.** Shore level displacement in Öregrundsgrepen. SKB-TR-99-16, Svensk Kärnbränslehantering AB
- Brydsten L, 1999b.** Change in coastal sedimentation conditions due to positive shore displacement in Öregrundsgrepen. SKB TR-99-37, Svensk Kärnbränslehantering AB
- Engqvist A, Andrejev O, 1999.** Water exchange of Öregrundsgrepen – A baroclinic 3d-model study. SKB TR 99-11, Svensk Kärnbränslehantering AB
- Engqvist A, Andrejev O, 2000.** Sensitivity analysis with regard to variations of physical forcing including two hydrographic scenarios for the Öregrundsgrepen – A follow-up baroclinic 3D-model study. SKB TR 00-01, Svensk Kärnbränslehantering AB
- Jerling L, Isaeus M, Lanneck J, Lindborg T, Schüldt R, 2001.** The terrestrial biosphere in the SFR region. SKB R-01-09, Svensk Kärnbränslehantering AB
- Karlsson S, Bergström U, Meili M, 2001.** Models for dose assessments. Models adapted to the SFR-area, Sweden. SKB TR-01-04, Svensk Kärnbränslehantering AB
- Kautsky H, Plantman P, Borgiel M, 1999.** Quantitative distribution of aquatic plant and animal communities in the Forsmark area. SKB R-99-69, Svensk Kärnbränslehantering AB
- Kumblad L, 1999.** A carbon budget for the aquatic ecosystem above SFR in Öregrundsgrepen. SKB R-99-40, Svensk Kärnbränslehantering AB
- Kumblad L, 2001.** A transport and fate model of C-14 in a bay of the Baltic Sea at SFR. – Today and in the future. SKB TR-01-15, Svensk Kärnbränslehantering AB
- Westman P, Wastegård S, Schoning K, Gustafsson B, Omstedt A, 1999.** Salinity change in the Baltic Sea during the last 8,500 years: evidence, causes and models. SKB TR-99-38, Svensk Kärnbränslehantering AB

5 Shore level displacement

The shore level displacement in Scandinavia has been compiled and modelled by /Påsse, 1996, 1997/. /Brydsten, 1999/ has calculated and animated the resulting change for the model area as well as Öregrundsgrepen. The report also contains a CD-ROM with the animations.

5.1 Introduction

Two areas have been studied; the local model area (see Chapter 4), the outer area which includes Öregrundsgrepen and part of the water area outside Öregrundsgrepen. The areas are strongly influenced by shore level displacement. As a result of ice melt at the end of the last glacial period, both glacio-isostatic land uplift and a rise in sea level have resulted in shore level displacement. The present rate of shore level displacement has been estimated by /Påsse, 1997/ to be approximately 0.6 cm/y. The theoretical progress of the shore level at Forsmark is shown in Figure 5-1 below.

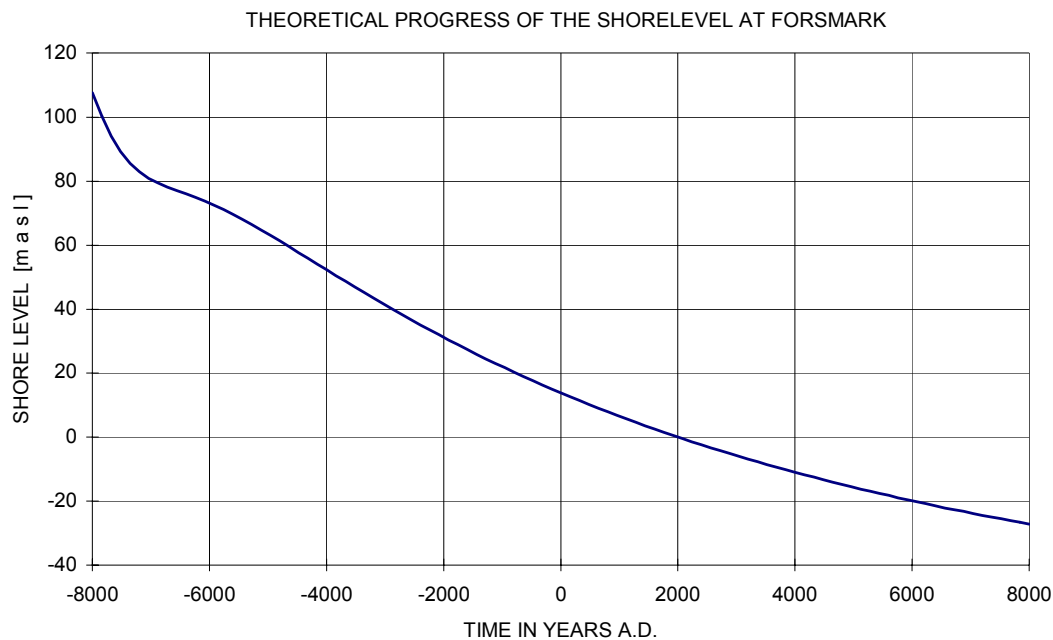

Figure 5-1. Shore level displacement as a result of land-rise and sea level change calculated average between Gävle and Stockholm from /Påsse, 1997/.

/Brydsten, 1999/ has modelled shore displacement in both Öregrundsgrepen and the local model area. The method is based on a digital elevation model (DEM) over the area, created from elevation point data from two different sources, using kriging as the interpolation method between irregularly spaced data points. DEMs were created for Öregrundsgrepen (50 metre grid) and the local model area (25 m grid). The effects of shore displacement on the landscape evolution can then be studied by using the shore displacement equation of /Påsse, 1997/ to calculate the elevation difference compared to the present day.

5.2 Today

5.2.1 Öregrundsgrepen

The prevailing water depth conditions in Öregrundsgrepen are shown in Figure 5-2.

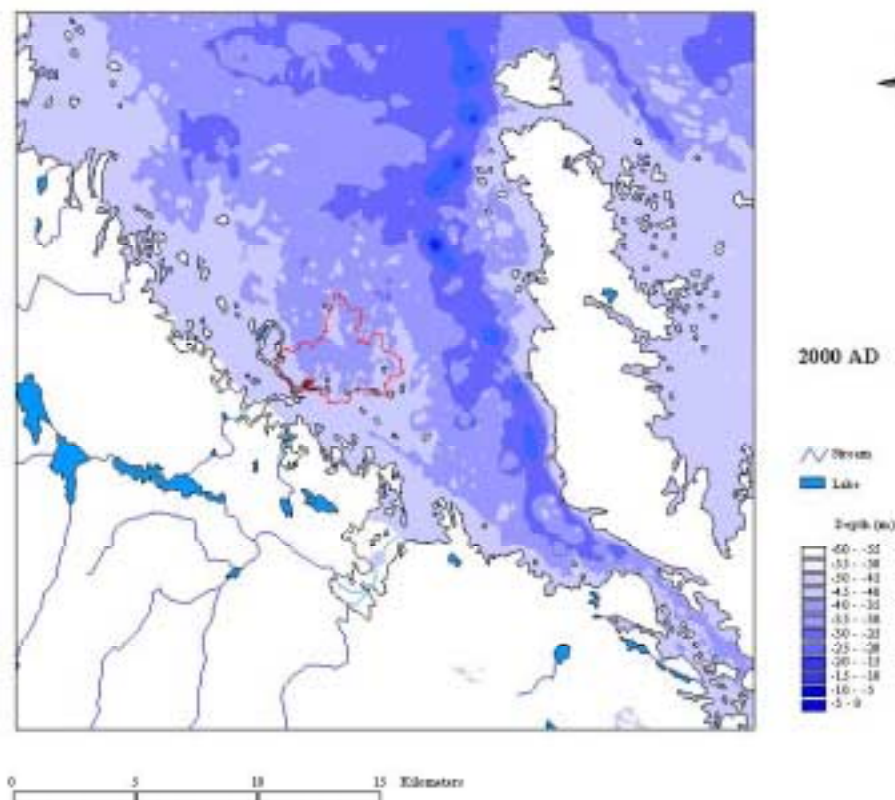

Figure 5-2. Öregrundsgrepen with the water depth conditions that prevail today (2,000 AD) /Brydsten, 1999/.

5.2.2 Local model area

The prevailing water depth conditions in the local model area are shown in Figure 5-3 below.

At present, the seawater table is about 6–10 m above the seabed in the area where SFR is located, and the shoreline is about 1,000 metres off the repository.

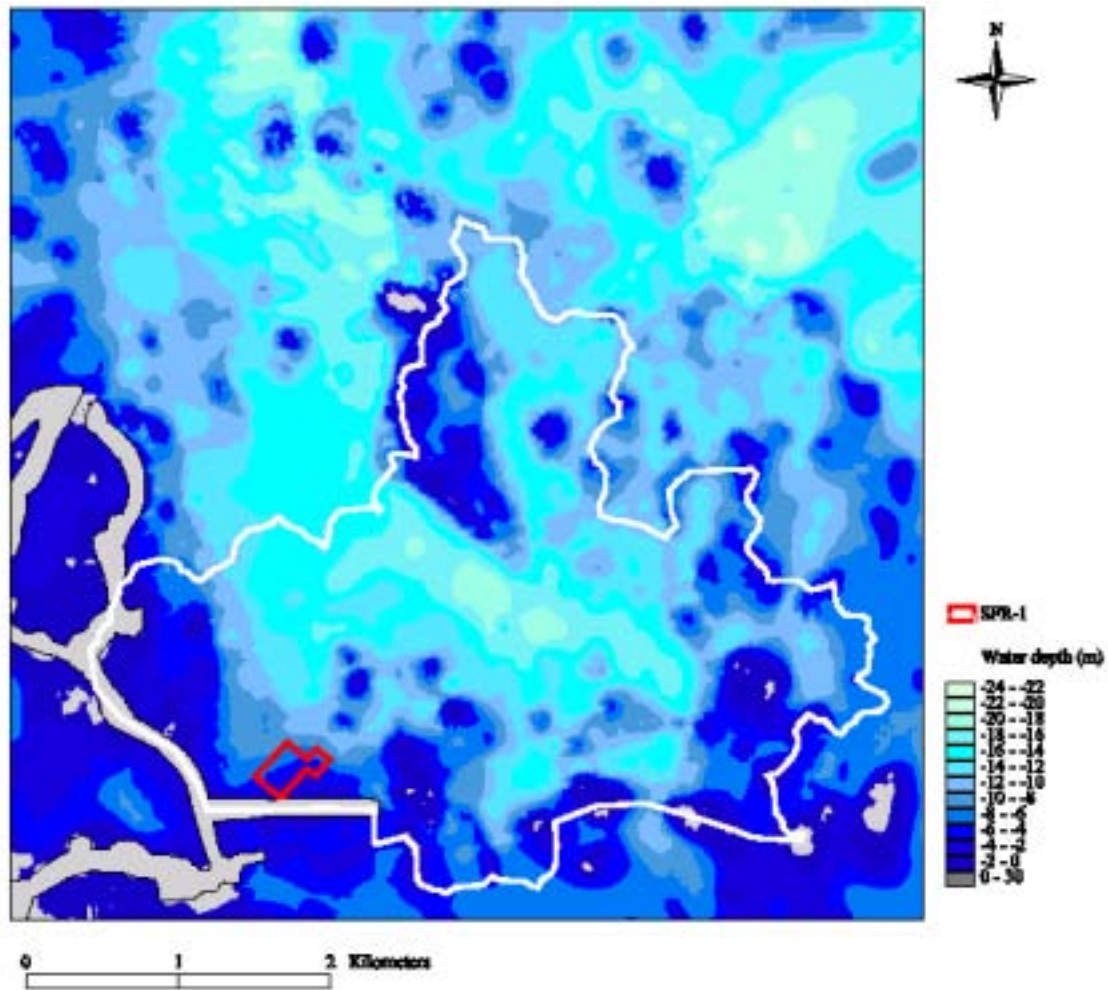

Figure 5-3. The water depth conditions prevailing today in the local model area. SFR is marked with a red line /Brydsten, 1999/.

5.3 Future development

The results of the modelling study are summarised below.

5.3.1 Öregrundsgrepen

3,000 AD

Initially, the major change in landscape evolution will occur close to the mainland and on the east side of Gräsö. The Öregrund strait will successively narrow and close at approximately 3,000 AD (Figure 5-4), i.e. the island of Gräsö will become part of the mainland. Öregrundsgrepen is transformed from a strait to a bay.

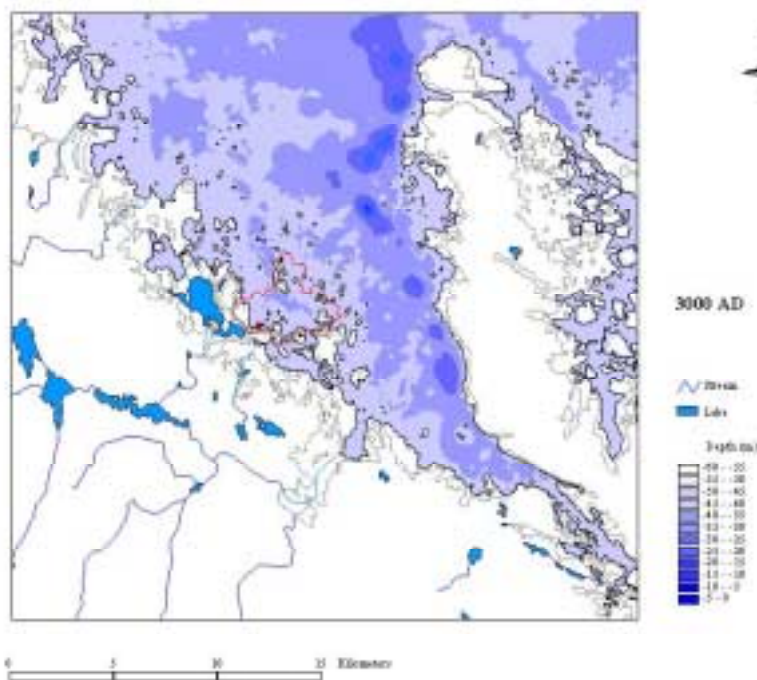

Figure 5-4. The water depth conditions in Öregrundsgrepen 3,000 AD shown on CD in /Brydsten, 1999/.

10,000 AD

Up until 4,000 AD most of the changes will occur close to the mainland and on the east side of Gräsö. The area around SFR is transformed to an archipelago and bay at 4,500 AD and then a lake at 5,000 AD (Figure 5-5).

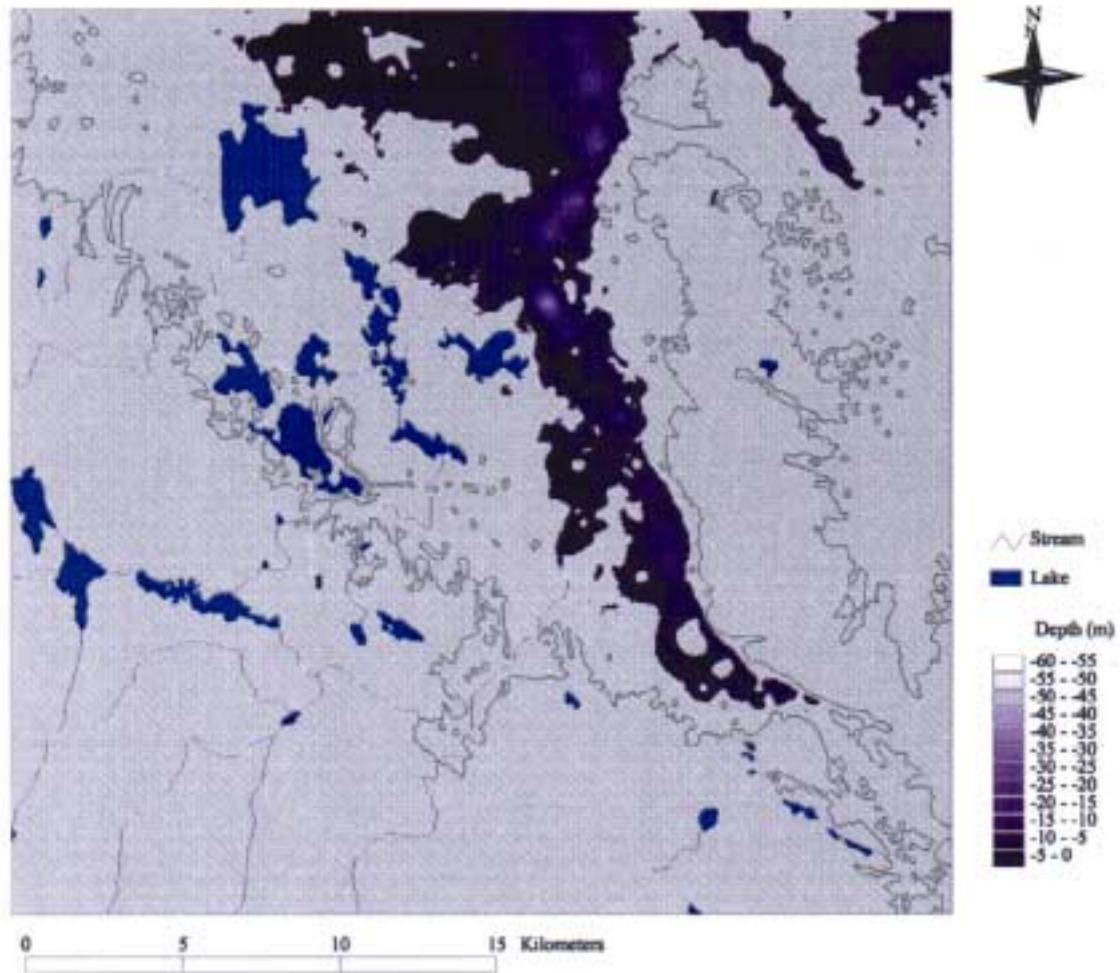

Figure 5-5. Öregrundsgrepen with the water depth conditions that will prevail 5,000 AD. Today's shoreline is marked /Brydsten, 1999/.

The change over time in the emergence of land is most rapid at the beginning of the period from the present day up to 7,000 AD. The decrease in brackish water area to 7,000 AD is shown in Figure 5-6. Half the water area in Öregrundsgrepen will become land within the next 2,000 years.

A large number of lakes will be formed in Öregrundsgrepen during the period 3,000 AD to 7,000 AD. The fourteen largest lakes are presented in Figure 5-7 and some of their characteristics are given in Table 5-1.

Large and deep lakes will be situated along the deep channel of the west of Gräsö. The future lakes will form a long chain of lakes along the northern fault fissure. The deepest of the future lakes is Lake 12, with a maximum depth of approximately 34 meters.

Many of the future lakes are shallow and will probably become filled with organic sediments. The basin fill process is most dependent on the basin depth, but other factors include nutrient status and water turnover. Four of the lakes will be small lakes with average depths lower than 1.5 m and a low theoretical water turnover (Lakes 2, 5, 7 and 8). These lakes are therefore potential future mires. Many of the remaining future lakes will partly have large shallows and will probably become lakes surrounded by organic soils. Further discussion of lake development in the area is given in Chapter 11.

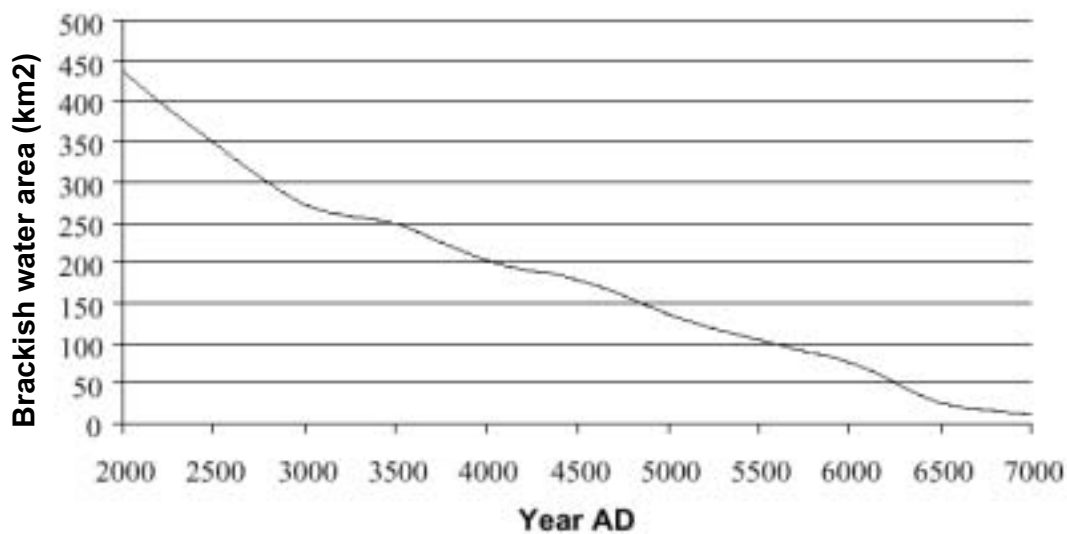

Figure 5-6. The area of the brackish water area from today (2,000 AD) to 7,000 AD. /Brydsten, 1999/.

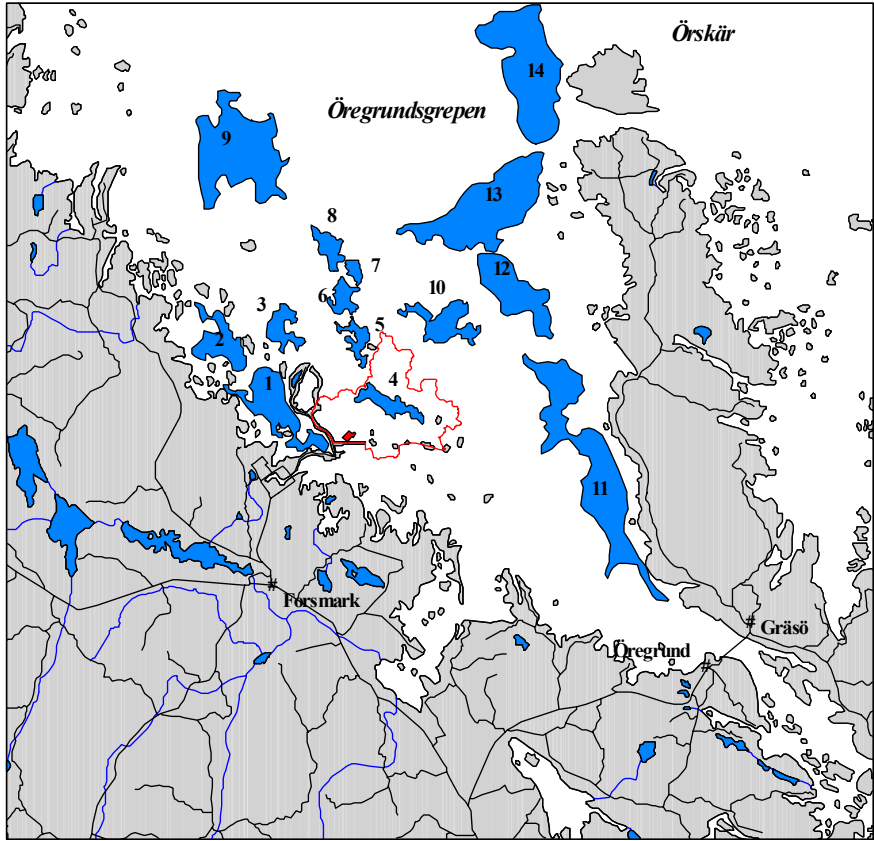

Figure 5-7. Future lakes in Öregrundsgrepen numbered according to Table 5-1. SFR is marked with a red symbol and the local model area with a red line /Brydsten, 1999/.

Table 5-1. Characteristics of future lakes in Öregrundsgrepen /Brydsten, 1999/. See Figure 5-7 for the location of the lakes.

Code	Elevation (m)	Area (km ²)	Volume (m ³ *10 ⁶)	Average depth (m)	Max depth (m)	Born (AD)
1	-3.60	3.08	8.3	2.7	6.0	2,600
2	-6.00	1.82	0.9	0.5	2.4	3,000
3	-9.30	1.04	1.7	1.6	4.2	3,600
4	-15.20	1.06	1.8	1.7	4.1	4,900
5	-15.20	0.74	1.0	1.3	4.2	4,900
6	-15.20	0.73	1.7	2.3	5.2	4,900
7	-15.20	0.31	0.3	0.9	2.0	4,900
8	-15.20	0.79	0.9	1.1	3.1	4,900
9	-15.70	7.11	25.0	3.5	7.2	4,900
10	-16.20	1.83	3.3	1.8	6.6	5,000
11	-21.40	8.14	33.3	4.1	19.3	5,400
12	-22.90	3.33	23.7	7.1	34.6	6,800
13	-22.90	7.12	36.4	5.1	22.3	6,800
14	-26.40	7.61	31.5	4.2	19.9	7,700

The rivers in the area, Forsmarksån and Olandsån, today have a common outlet to Öregrundsgrepen through Kallrigafjärden. In 6,000 AD this common outlet will discharge to the southernmost of the deep future lakes west of Gräsö. Thus, the water turnover in this future lake system will be relatively high. All other future lakes in the area will have low to extremely low theoretical turnover times, including the large future Lake 9, which will be a large lake both in area and volume, but will receive low inflow of water due to a small catchment.

5.3.2 Local model area

3,000 AD

The change in new land formation in the local model area during the period from today until 2,400 AD is undramatic. Existing islands grow in size and some new islands emerge from the sea. During the period 2,500 AD until 3,500 AD the area directly above SFR is drained gradually. A significant change will occur at about 2,900 AD when small lakes begin to be established directly downstream from SFR, and the shoreline is above the repository, see Figure 5-8.

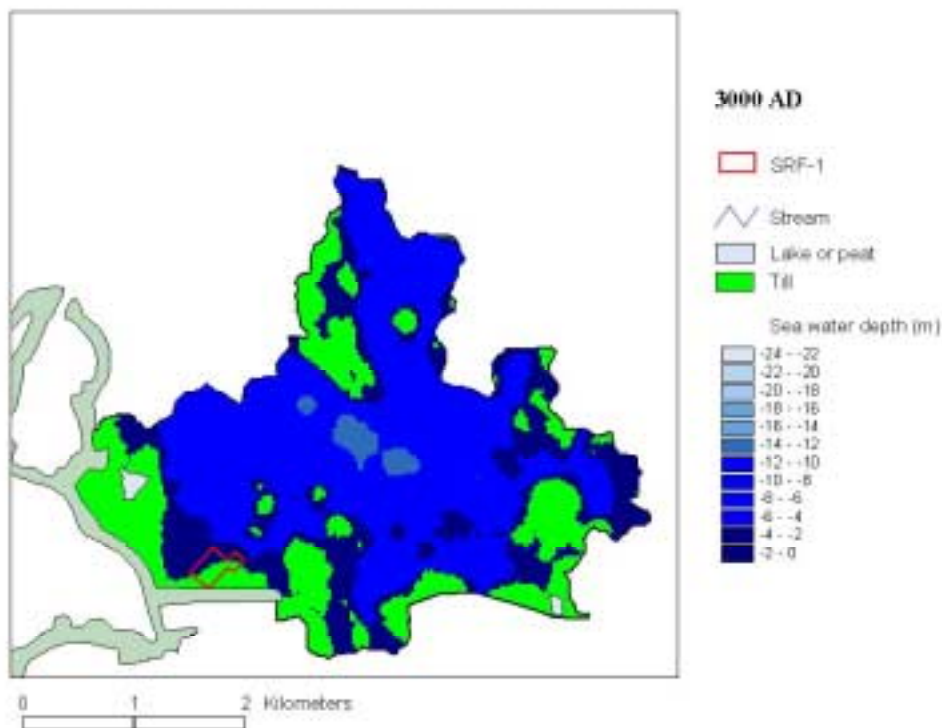

Figure 5-8. The water depth conditions in the inner model area 3,000 AD shown on CD in /Brydsten, 1999/.

10,000 AD

About 3,400 AD, the local model area will be closed off from both the southern and eastern directions and the only inlet to the area will be through a channel in the north. At 4,000AD an enclosed archipelago has formed (Figure 5-9). A model for the dynamics of carbon at this time is presented in Chapter 9.

By 4,500 AD, the greater part of the inner local model area will be drained and the remaining sea area will be a long narrow bay, sheltered against the open sea by an archipelago and finally isolated as a lake (no. 4) about 4,900 (Figure 5-10).

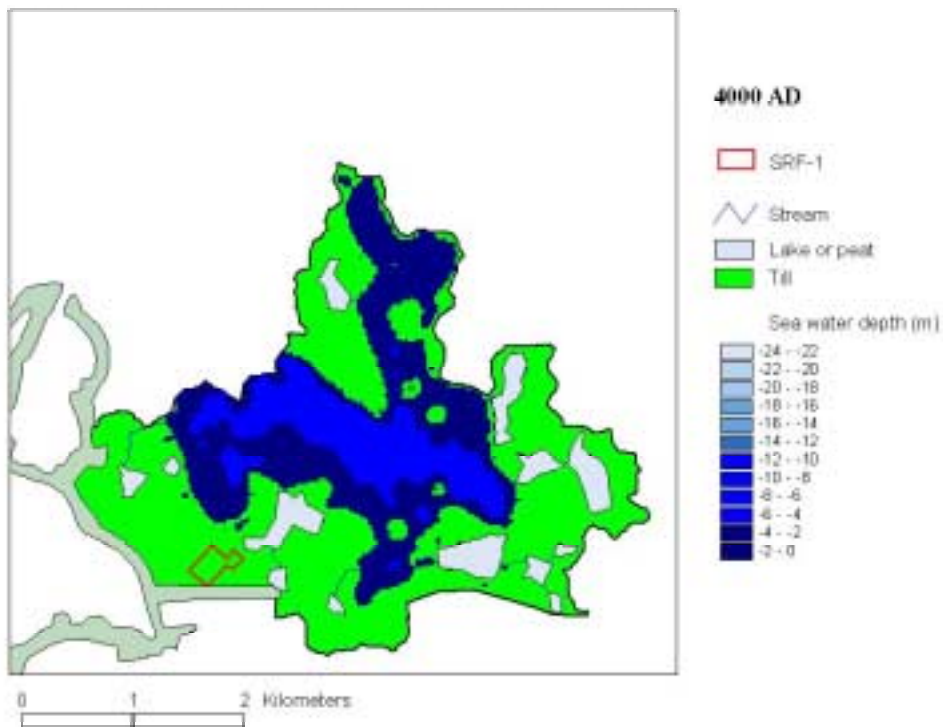

Figure 5-9. The water depth conditions in the local model area 4,000 AD shown on CD in /Brydsten, 1999/.

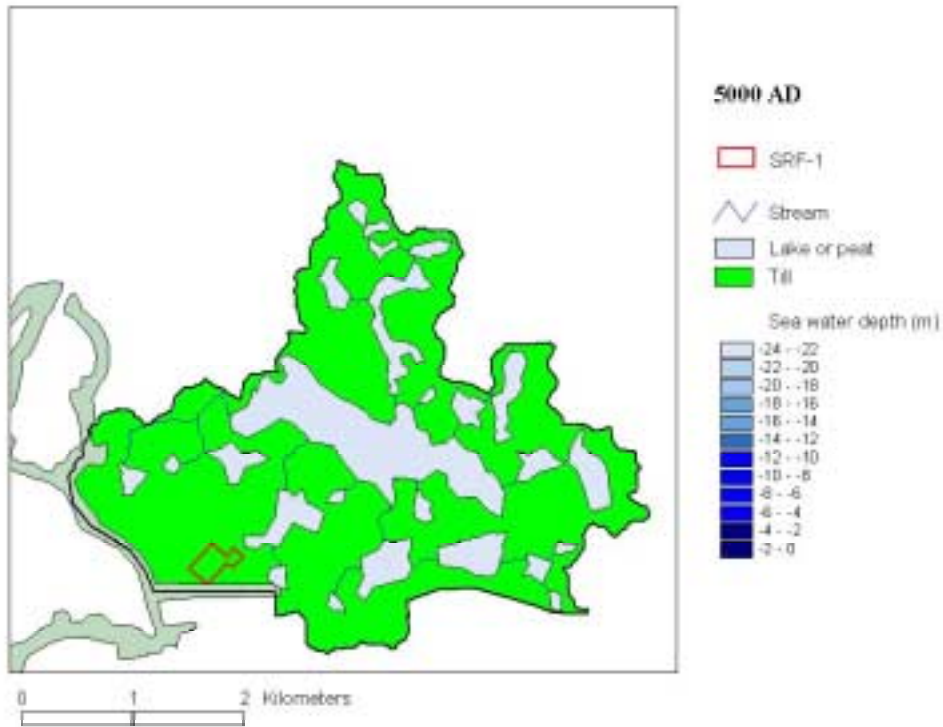

Figure 5-10. The water depth conditions in the local model area 5,000 AD /Brydsten, 1999/.

5.3.3 Hypsographic data 4,000 AD

/Kumblad, 2001/ has chosen the year 4,000 AD as a suitable time for modelling the carbon turnover in the local model area, as the model area still would be in contact with the coastal area. The open coast will however turn into a shallow archipelago with reduced water exchange compared to at present. Hypsographic information of the local model area at present (2,000 AD) and in 2,000 years (4,000 AD) is compiled in Table 5-2.

Table 5-2. Areas and percentages of different water layers to the total area for the local model area. In addition the same information for various types of bottoms. Water volumes are also given. Values for 2,000 AD and 4,000 AD, respectively.

Depth interval	Area (km ²)		Area (%) of total	
	2,000 AD	4,000 AD	2,000 AD	4,000 AD
Land	0.27	6.18	2.4	53.9
0–1 meters	0.29	0.86	2.6	7.5
1–2 meters	0.41	1.23	3.6	10.7
2–4 meters	0.90	1.89	7.8	16.5
4–6 meters	1.44	0.90	12.6	7.8
6–10 meters	2.84	0.41	24.8	3.6
10–15 meters	4.44	–	38.7	–
15–20 meters	0.87	–	7.6	–
Sea bed total	11.20	5.29	97.6	46.1
Area total	11.47	11.47	100.0	100.0
Photic zone	5.89	5.29	51.4	46.1
Aphotic zone	5.31	–	46.3	–
Volume (km ³)	0.11	0.0153	–	–

Source: /Brydsten, 1999/.

5.3.4 Position of the discharge zone

The position of the zone where discharge of groundwater from the SFR repository occurs is important with respect to the fate of radionuclides potentially contaminating the groundwater, as the type of environment into which the radionuclides are discharged determines the rate and direction of radionuclide transport in the biosphere.

The position of the discharge area will be affected by land uplift, as the topography and the position of the sea affect the groundwater flowpaths. The discharge areas are expected to follow the retreating shoreline, though the way in which the discharge areas move with the shoreline depends primarily on the velocity of the horizontal movement of the retreating shoreline in relation to the rate of the sediment accumulation. The positions of the groundwater discharge zones and their complicated interaction with shore level displacement, topography and the rate and extension of the sediment accumulation is discussed in /Holmén and Stigsson, 2001/.

5.4 References

Brydsten L, 1999. Shore level displacement in Öregrundsgrepen. SKB-TR-99-16, Svensk Kärnbränslehantering AB

Holmén J G, Stigsson M, 2001. Modelling of future hydrogeological conditions at SFR, Forsmark. SKB-R-01-02, Svensk Kärnbränslehantering AB

Kumblad L, 2001. A transport and fate model of carbon-14 in a bay of the Baltic Sea at SFR. – Today and in the future. SKB TR-01-15, Svensk Kärnbränslehantering AB

Påsse T, 1996. A mathematical model of the shore level displacement in Fennoscandia.
SKB TR 96-24, Sveriges geologiska undersökning, Göteborg,

Påsse T, 1997. A mathematical model of past, present and future shore level displacement in Fennoscandia.
SKB TR 97-28, Svensk Kärnbränslehantering AB

6 Deposits/sedimentation

This section is a synthesis of the information reported by /Brydsten, 1999/, /Meili et al., in manus/, /Sigurdson, 1987/ and /Kautsky et al., 1999/ concerning sediment characteristics and the distribution and movement of sediment in the Baltic Sea, Öregrundsgrepen and the local model area. The distribution of erosion/accumulation bottoms has also been calculated by Brydsten, using a model to simulate coastal sedimentation conditions in past, present and future conditions. The results of the modelling study are outlined in the following sections.

6.1 Deposits in terrestrial environments

The moraine in the area is calcium rich as a result of the southwards transport of sediments derived from the limestone lying on the seabed in the bay of Gävle /Sigurdsson, 1987/.

In addition, the process of land uplift results in the continuous cutting off from the sea of bays and inlets along the coast. Sedimentation and peat growth in the resulting lakes lead to an inhomogeneous accumulation of sediments onshore. The distribution of deposits in the terrestrial environment is therefore patchy.

6.2 Distribution of sediments

6.2.1 Baltic Sea

No detailed study of the distribution of sediments in the Baltic Sea has been made within the SAFE study. The fraction of accumulation bottoms has been assumed to 0.3 /Karlsson et al., 2001/. The sediment growth rate in the Baltic has been estimated to be 0.2 cm/year, based on the observed lamination structure and Cs-137 dating of sediment cores in offshore areas /Meili et al., in manus/. Future changes in the sedimentary conditions in the Baltic Sea have not been taken into account.

6.2.2 Öregrundsgrepen and local model area

Present day distribution of sediments

On the mainland side, Öregrundsgrepen has a shallow archipelago with a rocky bottom, partly covered with coarse moraine. The finer fractions of the moraine top layer have been flushed and transported away by waves and currents leaving sand, gravel, stones and boulders. In some places there are spots of glacial clay remaining, usually covered with a thin layer of sand /Sigurdsson, 1987/. Outside the archipelago the bottom is almost flat, gently tilted toward the north, except for the deeper trench off W. Gräsö.

Erosion and transport bottoms dominate in the area and sedimentation is therefore very small. Except for isolated spots, accumulation bottoms are only found in the groove along Gräsö, in parts of the Forsmarksfjärden west of the Biotest basin and in the shallowest, and less exposed bays. These are described as “soft bottoms” in Figure 6-1. The slope of the coastline and the exposure determine the sediment composition and the grain size.

The present day distribution of sediments, shown in Figure 6-1 below, is based on a summary of information in the literature.

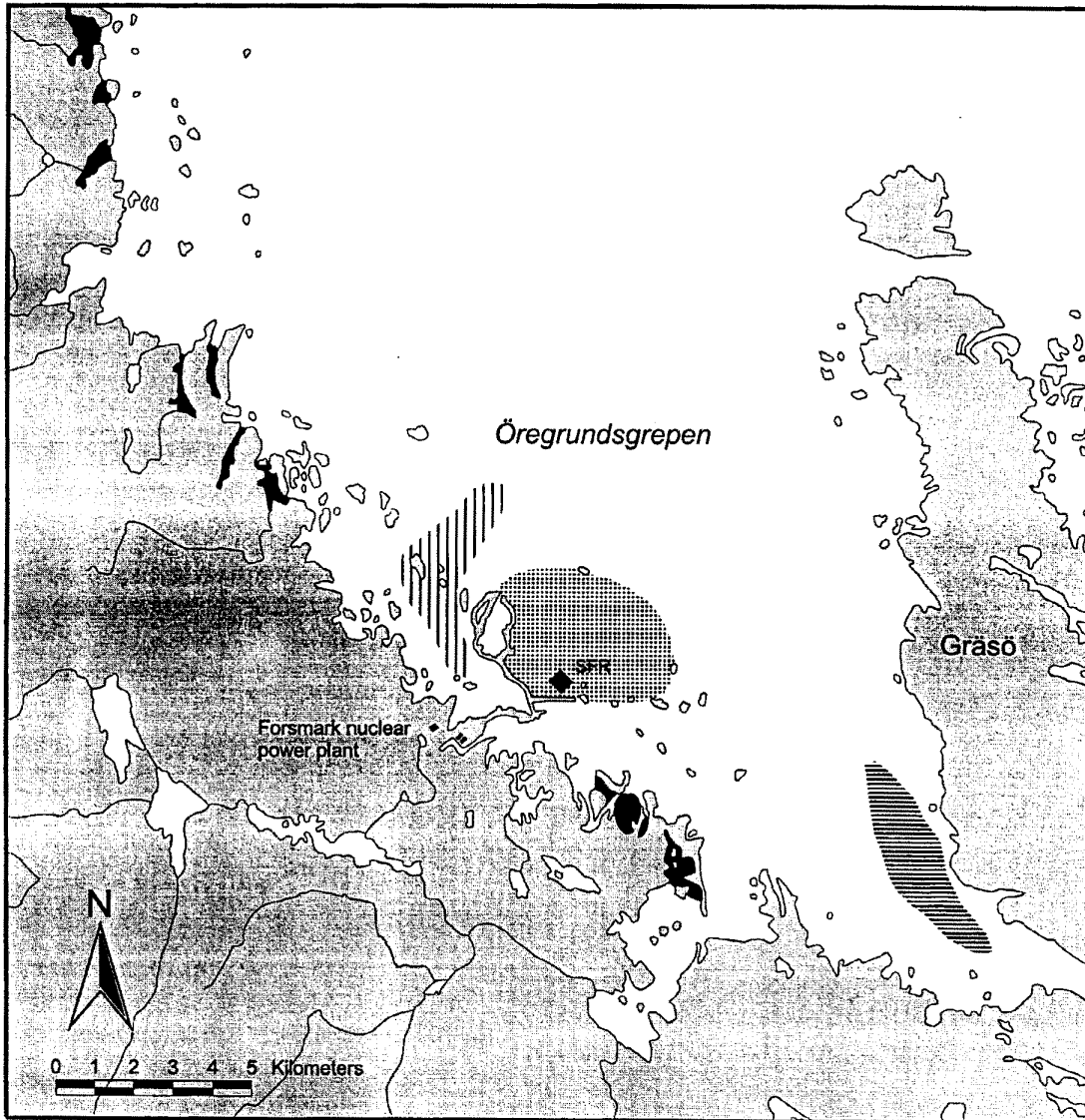

Sources: Wallström, "Grunda havsvikar i Uppsala län", 1997
 Gustavsson and Sköld, "sedimentkemiska undersökningar i Forsmarksområdet", 1984

- SFR.
- ▨ Study area
- Soft bottoms
 - ▨ Deep
 - Innermost creeks
 - ▨ Shallow open

Figure 6-1. Map of soft bottoms in Öregrundsgrepen.

The observations are confirmed by reports of divers investigating the local model area. Unstable substrates of stones, gravel and sand dominate in the area investigated by /Kautsky et al., 1999/ (five sites within the local model area).

The sediment growth rate in the Öregrundsgrepen and the local model area has been estimated to be 1 cm/year, based on the observed lamination structure and Cs-137 dating of coastal sediment cores /Meili et al., in manus/.

6.3 Development of erosion/accumulation bottoms

Due to the positive shore displacement (see Chapter 5) sedimentation conditions have fluctuated and will continue to fluctuate over time. Areas with accumulation bottoms can switch to erosion bottoms and vice versa. /Brydsten, 1999/ has simulated previous, present and future conditions using a mathematical model, which simulates the resuspension of fine particles caused by wave movement. The model simulates the wave-induced near bottom water dynamics based on meteorological data. By adjusting the water depth conditions in the sea, the model can be used to simulate both previous and future conditions. The areas studied were the same as those Brydsten modelled for the shore displacement.).

The model has been calibrated for four areas close to SFR, which provide a range of different sedimentation conditions. The model calibration led to the definition of an accumulation bottom as a bottom with a maximum resuspension grain size (MRGS) of less than 20 µm. Erosion bottoms were thus defined as bottoms that the model indicates have a MRGS larger than 20 µm.

The present-day extension of accumulation bottoms in both the local model area and the outer model area predicted by Brydsten is shown in Figure 6-2 below:

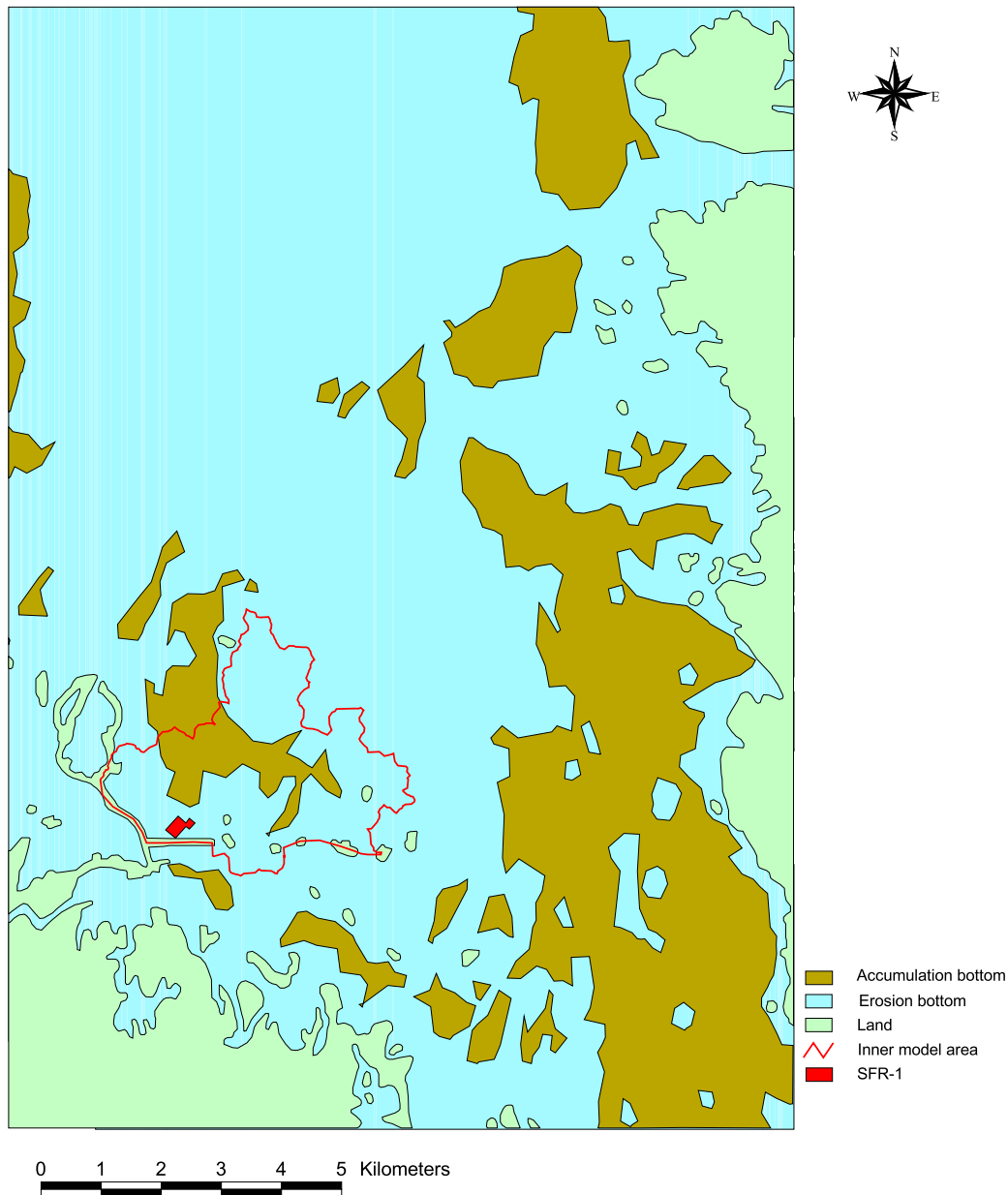

Figure 6-2. The extension of accumulation bottoms for the outer model area at present (2,000 AD). The accumulation bottom is defined as bottoms with average MRGS-values lower than $20 \mu\text{m}$. The black line is the present shoreline /Brydsten, 1999/.

The spreading of the current accumulation bottoms in the local model area predicted by the model predicts (Figure 6-2) is much more wide-spread than that shown in other investigations (Figure 6-1), and than observations by divers have been able to identify /Kautsky et al., 1999/. One reason for the difference between observed and modelled conditions can be that the shift from erosion to accumulative environments has occurred relatively late. The bottoms have not had time to build up with fine-grain sediment. Another reason could be that the availability of fine-grain particles in the local model area is limited after such a long period of extensive erosion.

6.3.1 General development

The results of the simulation show that sedimentation conditions change quickly, but normally a clear pattern is evident. Two opposing effects determine the distribution of accumulation and erosion bottoms; the shoaling and the wave energy filter effects of the coastal areas:

1. The shoaling effect is caused by the fact that the water's orbital movement of a wave decreases exponentially with the depth under the water surface. In other words, the shallower the water, the higher the horizontal orbital speed at the bottom and thus an increase in the ability for resuspension. The shoaling effect alone causes gradually lower numbers of accumulation bottoms as the positive shore displacement progresses.
2. The coast's wave energy filter effect is determined both by the density of the islands in coastal areas and the water depths of the coastal area. Waves with high energy generated in open sea brake on the island shores or when the waves pass shallow areas without breaking. The process results in high wave energies being filtered out while low wave energies are able to pass. Over time, the positive shore displacement results in increased density of islands and shallow areas becoming even shallower thus increasing the filter effect. An increased filter effect results in an increased number of accumulation bottoms.

A third effect, the wave breaking effect, occurs only at bottoms where morphometry results in breaking waves when the depth of water is less than approximately 5 meters. The water movements occurring under a breaking wave are generally much higher than wave-induced near bottom horizontal orbital movements under non-breaking waves. The number of accumulation bottoms therefore decreases again at near-shore shallow bottoms because the wave breaking effect dominates over the filter effect.

The predicted shift between the two types of bottoms over time for both the outer (solid line) and local model areas (dotted line) is shown in Figure 6-3 below for the period 5,000 BC to 3,000 AD.

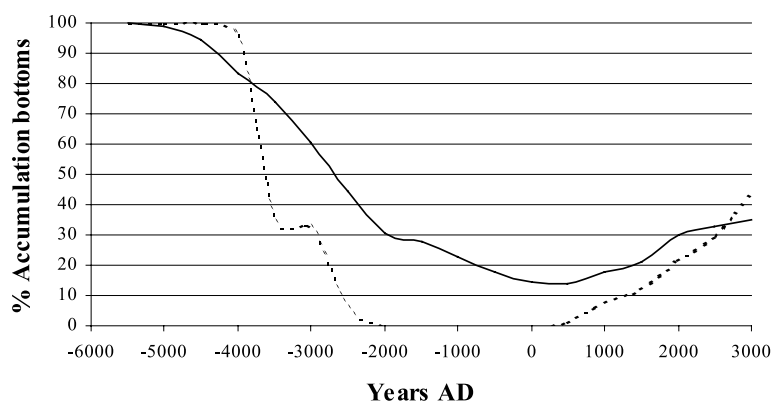

Figure 6-3. The change in % accumulation bottom over time for the outer (solid line) and local model area (dotted line) /Brydsten, 1999/.

The different sedimentation conditions can be interpreted as the shoaling effect dominating the filtering effect during the period –6,000 AD to 500 AD while the opposite situation occurs during the period 500 AD to the present.

The pattern should be general for all island coastal areas with positive shore displacement. The time of the minimum number of accumulation bottoms however and the degree of change of the coastal areas are determined by topography.

6.3.2 Outer model area – up to the present day

At the time the most recent glacial melted away from the region (–7,500 AD), the entire area was made up of accumulation bottoms. As the land rose and the area became more shallow, a shift from accumulative to erosional environments began approximately –5,550 AD. The fraction of accumulation bottoms reached a minimum of 14% in 500 AD. From this point until the present day, the fraction of accumulation bottoms increases to approximately 31% as a result of the growing archipelago, which provided protection from the waves of the open sea. Certain deep areas, such as the channel west of Gräsö, have had accumulation conditions for the entire post-glacial period.

Local model area – up to the present day

A comparison of the development of the outer and local model areas over time (Figure 6-3) shows that the local model area changed more quickly and consisted entirely of erosion bottoms during the period –2,000 to 500 AD. The local model area is more shallow, therefore a change initiated by a change in water depth influences the entire area faster.

The fraction of accumulation bottoms increased rapidly from 500 AD (0%) to the present (23%), primarily as a result of the increasing shallow areas that developed in the local model area's northern and north-eastern sections.

3,000 AD

The change in the extent of the accumulation bottoms from 500 AD to the present is primarily the result of the growth of existing accumulation areas. This trend will continue until at least 3,000 AD when approximately 43% of bottoms will be accumulation bottoms, as shown in Figure 6-4 below.

10,000 AD

Large parts of the area close to SFR have recently shifted from erosion bottoms to accumulation bottoms. This trend will continue until the area becomes land, around 2,400–3,500 AD /Brydsten, 1999/. As the area around SFR rises to become land, a large number of small lakes will form and a large lake will form approximately 5,000 AD about 2 km north-east of SFR.

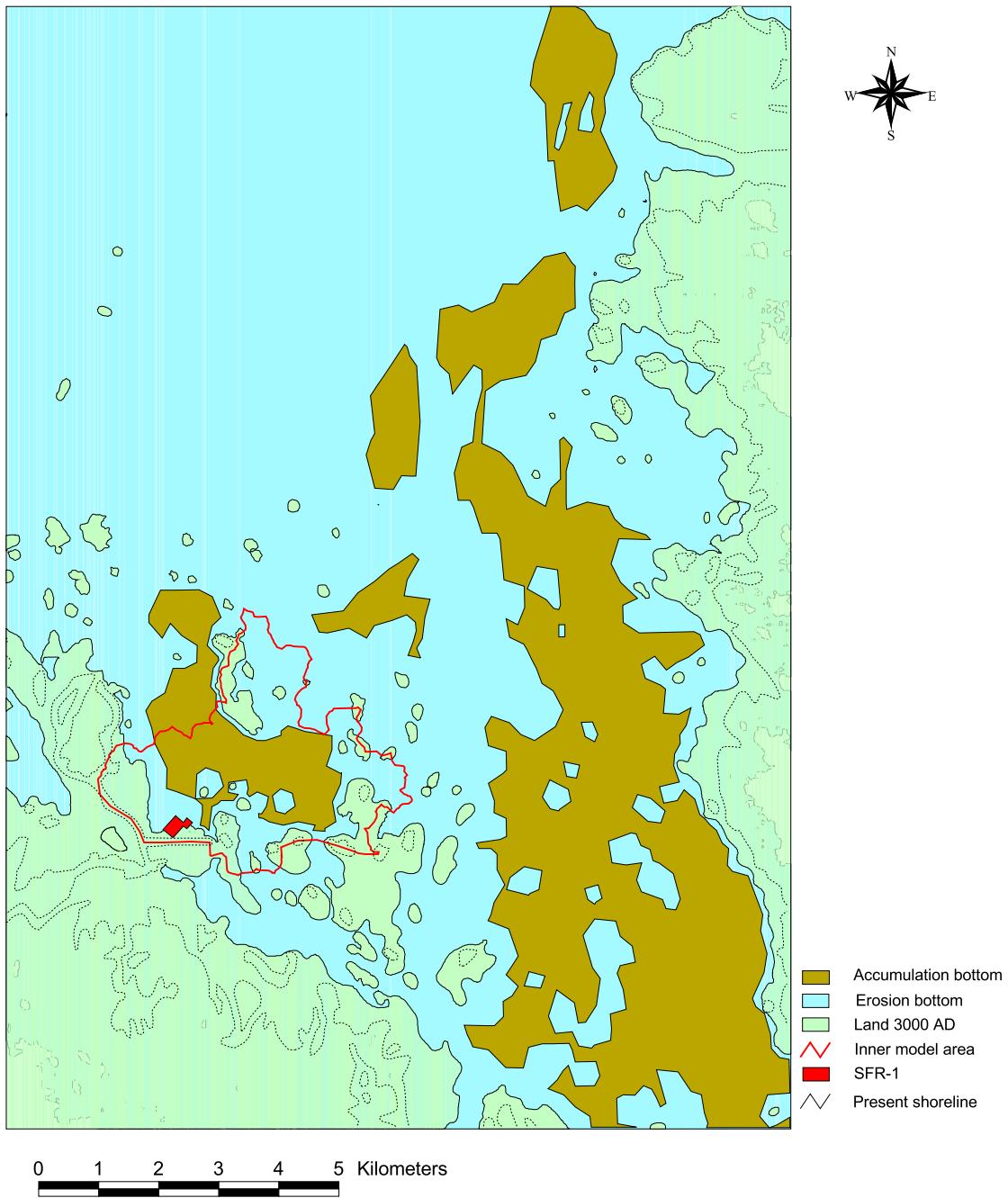

Figure 6-4. The extension of accumulation bottoms for the outer model area at 3,000 AD. The accumulation bottom is defined as bottoms with average MRGS- values lower than 20 μm . The dotted line is the present shoreline /Brydsten, 1999/.

6.4 Sediment characteristics

There is relatively little data on sediment characteristics, mainly because except for isolated spots, the present accumulation bottoms are so limited in extent. Where accumulation bottoms do occur, the sedimentation of especially organic matter, forming gyttja, would be expected from the morphology of the area. The organic matter content in these sediments is expected to be high, 15–40%, because of the high primary production in the area, see Chapter 9.

Some data has been obtained from six sediment cores collected from two sites within the local model area /Kautsky et al., 1999/. At six sampling points within the local model area, the bottom varied from even sandy bottoms with some stones and gravel, to a mixture of small and large boulders, stones and gravel, with occasional minor areas of sand. The occurrence of organic sediment was patchy.

The sediment cores were oxidised to a depth of 0.03 m at one of the sites and 0.001 m at the other. The mean organic content of the sediment at one of the sites was found to be 0.3%. The corrected mean values for chlorophyll-a and pheopigment contents about 4.0 µg/g sediment wet weight.

6.5 References

Brydsten L, 1999. Change in coastal sedimentation conditions due to positive shore displacement in Öregrundsgrepen.

SKB TR-99-37, Svensk Kärnbränslehantering AB

Karlsson S, Bergström U, Meili M, 2001. Models for dose assessments. Models adapted to the SFR-area, Sweden.

SKB TR-01-04, Svensk Kärnbränslehantering AB

Kautsky H, Plantman P, Borgiel M, 1999. Quantitative distribution of aquatic plant and animal communities in the Forsmark area.

SKB R-99-69, Svensk Kärnbränslehantering AB

Meili M, Holmberg P, Jonsson P, Persson J, in manus. Characteristics, fluxes, and ¹³⁷Cs content of sediments along the Swedish coast of the Bothnian Sea.

SKB TR-xx-xx, Svensk Kärnbränslehantering AB

Sigurdsson T, 1987. Bottenundersökning av ett område ovanför SFR, Forsmark.

SKB SFR 87 07, Svensk Kärnbränslehantering AB

7 Water turnover

Water turnover is one of the major factors affecting the exposure and dispersal of radionuclides in the biosphere. The water turnover was modelled in /Enqvist and Andrejev, 1999/ and a sensitivity analysis was used to explore different scenarios in /Enqvist and Andrejev, 2000/. The underlying concepts of these reports are described in /Enqvist, 1997/.

7.1 Water turnover in the Baltic Sea

The water retention time in the Baltic Sea has been estimated to be 22 years /Sjöberg, 1992/.

7.2 Water turnover in Öregrundsgrepen and the local model area

/Enqvist and Andrejev, 1999/ have estimated the water exchange during a representative full year cycle in Öregrundsgrepen and the local model area using a 3D model.

The model's forcing factors are atmospheric and hydrographic. The year 1992 was chosen for the atmospheric forcing factors (air pressure, wind velocity and direction, air temperature, humidity, cloudiness, precipitation, solar radiation).

7.2.1 Exchange mechanisms in Öregrundsgrepen

The dominating mechanism of water exchange is the intermediary circulation. This type of exchange is induced by the densimetric fluctuations of the adjacent Baltic coastal water induced by up-/down-welling events when along-coast winds transport surface coastal water sea-/coastwards. This type of circulation is enhanced in Öregrundsgrepen by the wide cross-section of the northern interface and the absence of any marked sill. This baroclinic-type of exchange was estimated in /Engqvist and Andrejev, 1999/ to be equivalent to a long-term mean flow of approximately $13 \cdot 10^3 \text{ m}^3/\text{s}$.

Differences in sea level induce barotropic circulation, which also contributes to the ventilation of the Öregrundsgrepen water. A coarse estimate may be achieved if 5 cm/day, representing a 10-year mean rate of change of the sea level at 60.5° latitude according to /Engqvist and Andrejev, 1999/, is multiplied with the Öregrundsgrepen surface area of about 400 km². This calculation gives a volume flow of 230 m³/s, which is orders of magnitude smaller than the baroclinically induced flows across the northern boundary. Sea level differences between the northern and southern parts of the Öregrundsgrepen may be maintained by the prevailing wind regime in combination

with the off-coast circulation resulting in a barotropic flow component through the Öregrund strait with current velocities of considerable magnitude. The mean through-flow has been estimated to $540 \text{ m}^3/\text{s}$.

7.2.2 Modelling the water exchange

The hydrographic factor of dominating importance is the boundary condition along the north westerly boundary of Öregrundsgrepen with the Baltic. Thus the first phase of modelling consisted of running a model encompassing the entire Baltic Sea in order to generate coherent densimetric (combined salinity and temperature) and sea level elevation boundary data relative to the adjacent Baltic coastal water.

This model resolves the Baltic horizontally in five by five nautical miles ($5' \times 5'$). The model was driven by gridded (approx. $20' \times 20'$) synoptic weather data with geostrophic wind and the varying density and sea level elevation on the Kattegat border. Freshwater discharge from the major rivers along the Baltic coastline was also taken into account.

The second phase consisted of running a local model over the Öregrundsgrepen with a higher horizontal grid resolution consisting of a $0.1' \times 0.1'$ grid. This model was driven by the same weather data, combined with the saved densimetric and sea level elevation boundary data that were produced by the Baltic model with the coarser grid. This procedure applies both for the wide northern and the narrow southern interface. Local stream discharge in the Öregrundsgrepen area has been taken into account, though it is of little importance.

Special emphasis has been placed on estimating the ventilation of the local model area, located above the SFR-repository, within the Öregrundsgrepen model area. The exchange intensity, expressed as a yearly average transit retention time, spanned from 0.5 days (surface) to 1.2 days (bottom) with regard to the depth strata that the model resolves. The bulk volume average for all strata was 0.77 days with a standard deviation of 0.22 days equally for both intra-monthly and inter-monthly variations. The corresponding average total volume flow across the boundary was $2.1 \cdot 10^3 \text{ m}^3/\text{s}$.

7.2.3 Predicted water exchange in Öregrundsgrepen

The retention time of Öregrundsgrepen was found to vary between 12.1 days (surface) and 25.8 days (bottom) as a yearly average.

In Figure 7-1, the spatial distribution of the modelled transit retention time in Öregrundsgrepen is shown for three occasions during the modelled year; January 31st, June 30th and December 31st. The rejuvenation of the surface water either from the northern and southern boundaries or at the mouth of the Kallriga local estuary can be seen, although this latter effect is counteracted by a tendency towards recirculation. In more secluded coastal areas with no freshwater discharge, the more or less stagnant water is obviously of higher age.

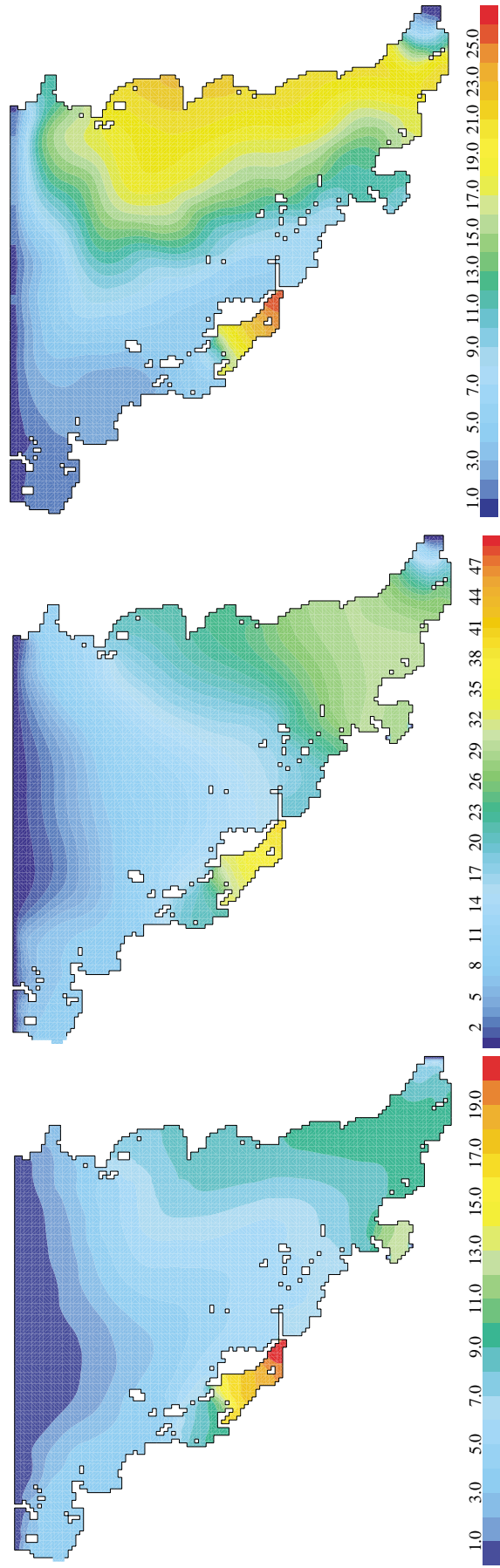

Figure 7-1. *Modelled transit retention times (days) distribution within Öregrundsgrepen. a) 1992-01-31, b) 1992-06-30, c) 1992-12-31 /Engqvist and Andrejev, 1999/.*

The vertical gradients for both temperature and salinity along the cross-section in Öregrundsgrepen were found to be very weak, i.e. there is very little stratification. Slight thermal stratification was observed in June, but this diminished quickly due to the effect of strong winds.

Table 7-1 below shows the monthly average retention times at different depths in Öregrundsgrepen. The yearly average for each depth is also shown.

The retention time for all layers increases to a maximum during the summer, declining and stabilising by the end of the year, when the retention times of all layers were approximately the same. The average retention time does not monotonously increase with depth but has a minimum for the layer centred around 40 m of depth. The statistical distribution of the predictions of retention times is summarised in Figure 7-2.

Table 7-1. Monthly averages and yearly average of retention times (days) at different depths of Öregrundsgrepen /Enqvist and Andrejev, 1999/.

	Depth of layer midpoint (m)									
	1	5	10	15	20	25	34	40	50	60
Jan	2.0	2.1	2.0	2.1	2.5	3.1	3.3	3.2	4.9	9.6
Feb	3.7	3.8	3.7	3.8	4.4	5.6	5.8	5.7	9.1	12.5
Mar	6.0	6.0	5.9	6.1	6.5	7.7	7.5	6.7	12.0	19.6
Apr	9.0	8.8	8.0	7.6	7.8	8.7	7.6	5.6	10.3	23.3
May	10.9	10.7	9.9	9.1	8.5	8.7	7.3	5.4	15.5	24.5
Jun	16.2	16.1	15.5	15.8	17.2	19.6	18.1	14.8	35.0	40.4
Aug	13.2	13.0	12.3	11.5	10.6	10.6	8.5	5.6	22.1	42.2
Sep	17.3	17.2	16.3	15.8	16.1	17.6	15.3	11.0	19.2	33.8
Oct	19.0	19.0	18.1	17.2	17.3	19.1	17.1	13.4	23.2	36.5
Nov	17.8	17.6	16.7	15.9	15.5	16.8	14.7	11.0	19.0	19.6
Dec	17.6	17.6	17.4	17.3	17.4	18.9	16.5	12.5	21.5	21.9
Avg.	12.1	12.0	11.4	11.1	11.2	12.4	11.1	8.6	17.4	25.8

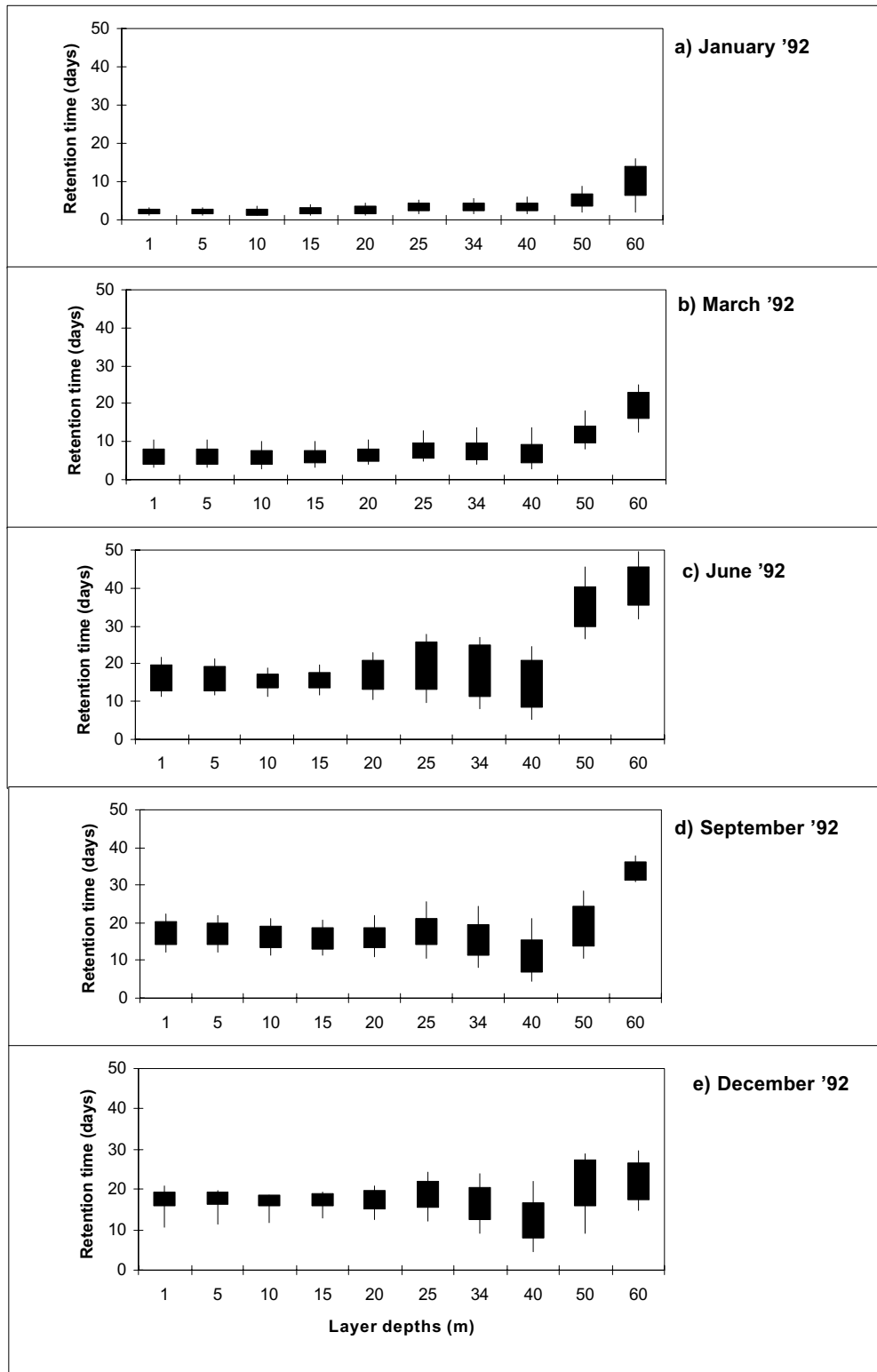

Figure 7-2. The variation in the average retention time at different depths in Öregrundsgrepen. The thin line connects the maximum and minimum values. The broader line shows ± 1 S.D. relative to the monthly average /Engqvist and Andrejev, 1999/.

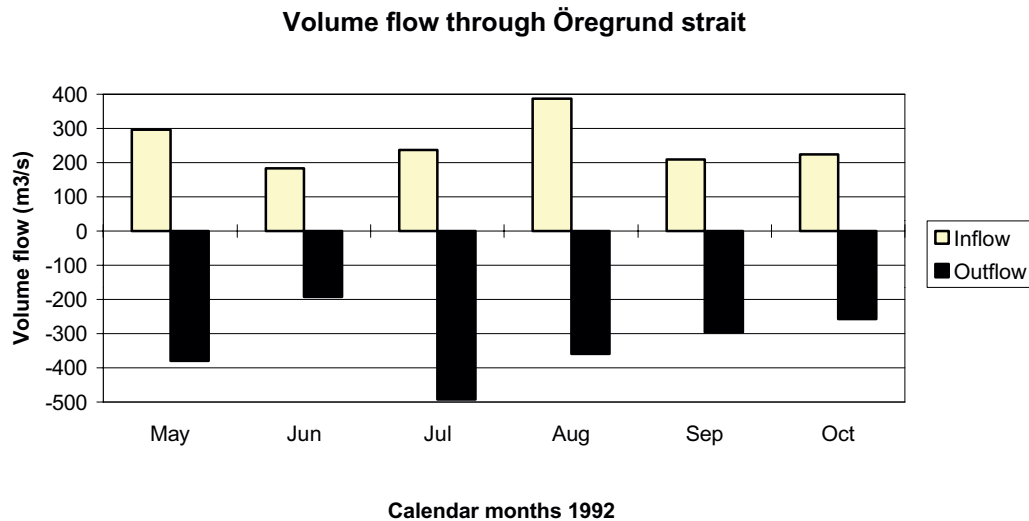

Figure 7-3. Volume flow through the souther strait of Öregrundsgrepen, near Öregrund /Engqvist and Andrejev, 1999/.

The volume flux through Öregrundsgrepen is shown in Figure 7-3. The nature of these flows is believed to be mainly barotropic, i.e. the opposing flows mostly occur separately in time. The inflow corresponds to currents in the northerly direction. It is clear that the south-going currents dominate.

7.2.4 Predicted water exchange in the local model area

Special emphasis has been placed on estimating the ventilation of the local model area, located above the SFR-repository, within the Öregrundsgrepen model area. The exchange intensity, expressed as a yearly average transit retention time, spanned from 0.5 days (surface) to 1.2 days (bottom) with regard to the depth strata that the model resolves. The bulk volume average for all strata was 0.77 days with a standard deviation of 0.22 days equally for both intra-monthly and inter-monthly variations. The corresponding average total volume flow across the boundary was $2.1 \cdot 10^3 \text{ m}^3/\text{s}$.

The monthly average retention times for each of the four layers of the local model area are listed in Table 7-2. The annual average values are also shown in the table.

Table 7-2. Monthly resolved retention time (days) of the local model area with regard to depth and the average volume flow (m³/s) across the model border.

	Layer 1 (days)	Layer 2 (days)	Layer 3 (days)	Layer 4 (days)	Volume average (days)	Total volume flow (m ³ /s)	PlugFlow ret. time (days)
Jan	0.266	0.355	0.507	0.666	0.447	6008	0.148
Feb	0.400	0.484	0.666	0.882	0.605	1775	0.501
Mar	0.496	0.552	0.731	0.993	0.688	2035	0.437
Apr	0.512	0.556	0.672	0.809	0.635	2414	0.369
May	0.620	0.691	0.965	1.461	0.924	1350	0.659
Jun	0.699	0.791	1.216	2.221	1.212	751	1.185
Jul	0.629	0.683	0.936	1.660	0.964	1626	0.547
Aug	0.656	0.684	0.905	1.556	0.937	1241	0.717
Sep	0.650	0.693	0.858	1.359	0.881	1389	0.641
Oct	0.574	0.631	0.771	1.080	0.759	1827	0.487
Nov	0.564	0.581	0.669	0.812	0.653	2180	0.408
Dec	0.472	0.498	0.592	0.712	0.566	2950	0.302
Avg.	0.545	0.600	0.791	1.184	0.773	2129	0.418
S.D.	0.124	0.119	0.195	0.472	0.215	1353	0.260
%	23	20	25	40	28	64	62

As for Öregrundsgrepen, the retention times increase towards the bottom and peak during the month of June.

The average retention time over the entire local model area has also been computed taking into account the volume of the respective layers. The corresponding volume flows passing through the layers have been calculated and the total flow passing through the local model area is also shown in Table 7-2 above. The variation in the monthly average transit retention times for the four layers of the local model area are shown in Figure 7-4.

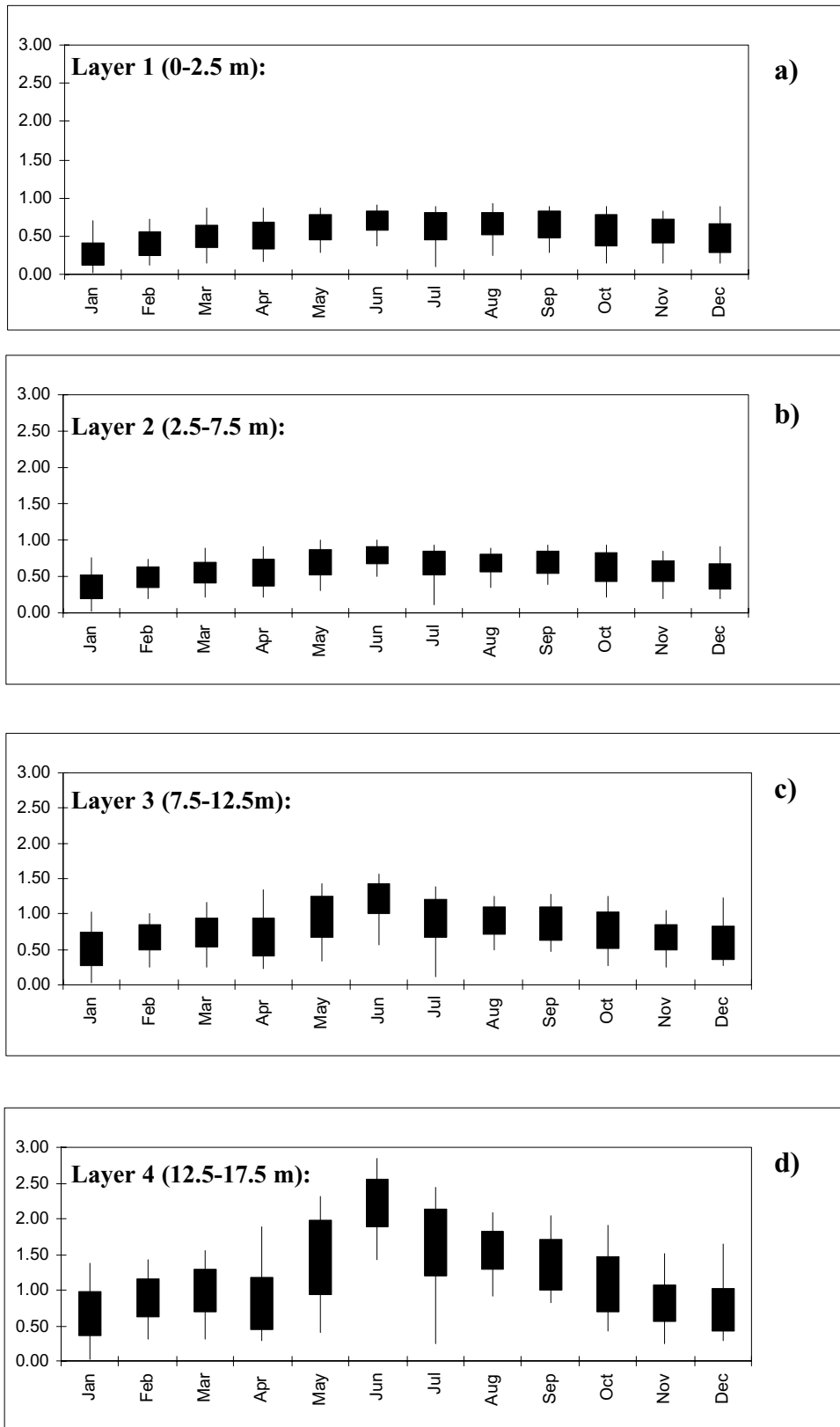

Figure 7-4. Variation in the monthly average transit retention times for the four layers of the local model area. The thin line connects the maximum and minimum values. The broader line shows ± 1 S.D. from the average value /Engqvist and Andrejev, 1999/.

Again it can be seen that the retention time increases toward the bottom and has a marked peak for the summer months when the thermal stratification produces buoyancy forces that counteract vertical mixing. The inter-monthly variation of the transit time for the entire local model area amounts to 0.220 days, or 29% of the average value (0.77 days) (see Table 7-2).

7.3 Future development

A sensitivity analysis of the model used to predict water turnover in Öregrundsgrepen and the local model area /Engqvist and Adrejev, 1999/ with regard to variations of the physical forcing factors has been performed by /Engqvist and Adrejev, 2000/. Again, data for the whole-year period of 1992 has been used. The results of these variations are compared to a nominal run with unaltered physical forcing. This nominal simulation is based on the experience gained in the whole-year modelling of the same area; the difference is mainly that the present nominal simulation is run with identical parameters for the whole year. From a computational economy point of view it has been necessary to vary the time step between the month-long simulation periods. For all simulations with varied forcing, the same time step as for the nominal run has been used. The analysis also comprises the water turnover of the local model area. The external forcing factors that have been varied are increase and reduction of atmospheric temperature, increase and reduction of the local freshwater discharge rate, increase and reduction of the salinity range at the boundary of the area with the Baltic and a reduction in the wind speed.

For the local model area, the ranking order of impact on the retention time is as follows (with the yearly average influence on the retention time given within parentheses).

1. Decreasing the local freshwater discharge by 50% (0.01%)
2. Increasing the atmospheric temperature by 2.5 °C (−0.1%)
3. Reducing the atmospheric temperature by 2.5 °C (0.6%)
4. Increasing the salinity variation range by 100% (−0.8%)
5. Increasing the local freshwater discharge by 100% (−1.6%)
6. Decreasing the wind (local and large-scale) by 10% (8.6%)

The most dominating factor is the wind speed. A 10% reduction in wind speed results in increased retention time for all layers and throughout the whole year for both Öregrundsgrepen and the local model area. In the local model area, the retardation of water circulation is more marked for the bottom layers, indicating that the dampened general circulation of Öregrundsgrepen is also reflected by a slower local baroclinic ventilation.

The predicted annual average water retention times were relatively insensitive to the other forcing factors.

Two additional full-year simulations of possible future hydrographic regimes have also been performed. The first mimics a hypothetical situation with permanent ice cover, which increases the average retention time 87%. The second regime entails the future hypsography with its anticipated shoreline displacement by an 11 m land-rise in the year 4,000 AD, which also considerably increases the average retention times for the two remaining layers of the BioModel area when simulated with the same forcing as for the nominal run.

7.3.1 10,000 years

Changes due to land rise

The change in water turnover expected to result from the future land rise regime was studied by carrying out a run with the nominal parameters but with a Baltic and Öregrundsgrepen hypsography modified according to the anticipated shoreline displacement for the year 4,000 /Påsse, 1997/. The resulting retention times are presented in Table 7-3 below for both Öregrundsgrepen and the local model area. The retention times are presented as the ratios of the predicted value for the land-rise regime and the value from the nominal run. The two lower layers have disappeared as a result of land rise.

Table 7-3. The monthly average differential transit retention times (days) expressed relative to the nominal run for different depth layers.

Month	ÖG Depth (m)								BM Depth (m)	
	1	5	10	15	20	25	31	40	1	5
1	1.46	1.10	1.16	1.37	0.62	-0.74	-0.42	1.56	4.176	1.928
2	2.19	1.70	1.84	2.18	1.12	-0.97	-0.42	2.55	5.956	2.263
3	2.94	2.22	1.87	2.19	0.71	-1.97	-0.59	3.71	7.551	2.310
4	2.90	2.12	1.93	2.36	0.62	-2.57	-1.22	4.28	9.272	2.392
5	3.82	2.74	1.88	2.15	0.60	-1.67	0.78	6.78	10.751	2.530
6	2.59	1.03	0.29	0.95	-1.28	-4.50	2.06	17.76	12.448	2.506
7	2.29	0.63	-0.32	-0.52	-3.32	-7.71	-4.40	6.41	13.995	2.437
8	4.77	3.29	2.25	2.08	-0.29	-4.11	-2.15	3.05	15.507	2.262
9	5.22	3.58	2.93	2.43	-1.11	-7.24	-6.65	-2.09	17.176	2.374
10	3.13	1.84	1.75	2.16	0.82	-1.73	-0.65	2.88	18.664	2.162
11	3.58	2.17	1.85	2.33	1.12	-1.07	0.40	4.54	20.181	2.217
12	4.29	2.80	2.59	3.01	1.63	-0.43	0.79	4.88	21.537	2.075
Avg.	3.27	2.10	1.67	1.89	0.10	-2.89	-1.04	4.69	13.101	2.288

A more detailed picture of the temporal variation in Öregrundsgrepen is given in Figure 7-5. Water rejuvenation takes place at an intermediary level which indicates that intermediary circulation is the dominant process. A conspicuous vertical symmetry occurs at mid-depths due to the formation of a new sill. In general, the retention times of the deeper layers are much shorter than those of the nominal run.

Retention time Öregrundsgrepen: Land rise 4,000 AD

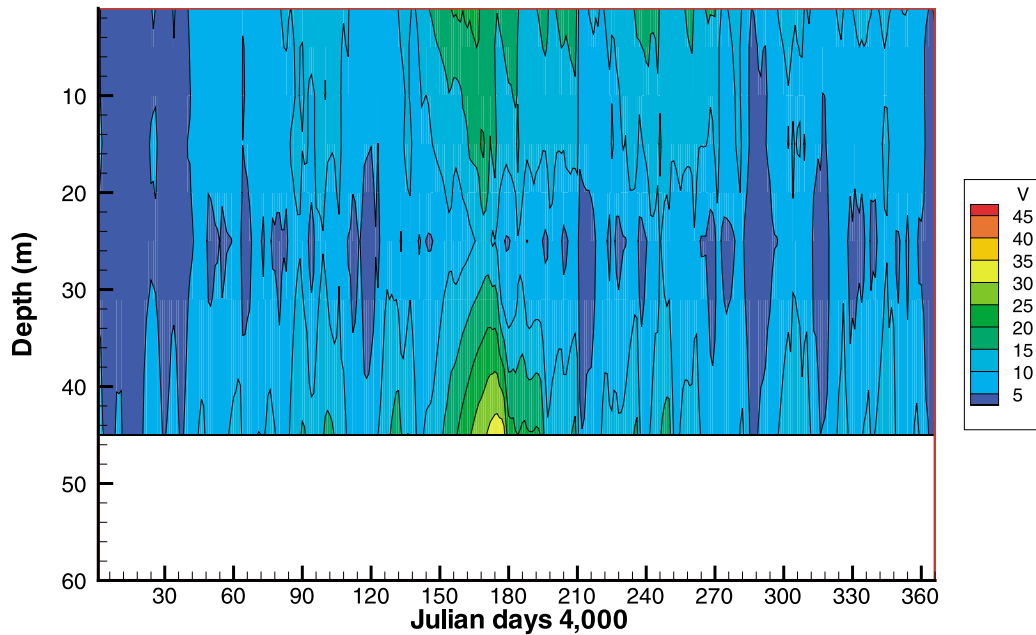

Figure 7-5. The volume retention time (days/m^3) at different levels of Öregrundsgrepen over a one-year period predicted for the year 4,000 AD /Engqvist and Andrejev, 1999/.

In the local model area, the renewal of bottom water is considerably faster than the renewal of the more voluminous surface water layers. This indicates that exchange through the narrow, elongated entrance to the local model area will be determined by baroclinic processes. The retention times over the modelled one-year period of the top and bottom layers in the local model area are shown in Figure 7-6 together with the retention times of the different layers in the nominal run. The top layer reaches a quasi-equilibrium in just less than three days. The lower layer (top curve) does not reach steady state during the simulated year. This means that the estimated yearly averages given in Table 7-3 are underestimates. The annual average value given in the table for the top layer could be doubled to give a conservative estimate.

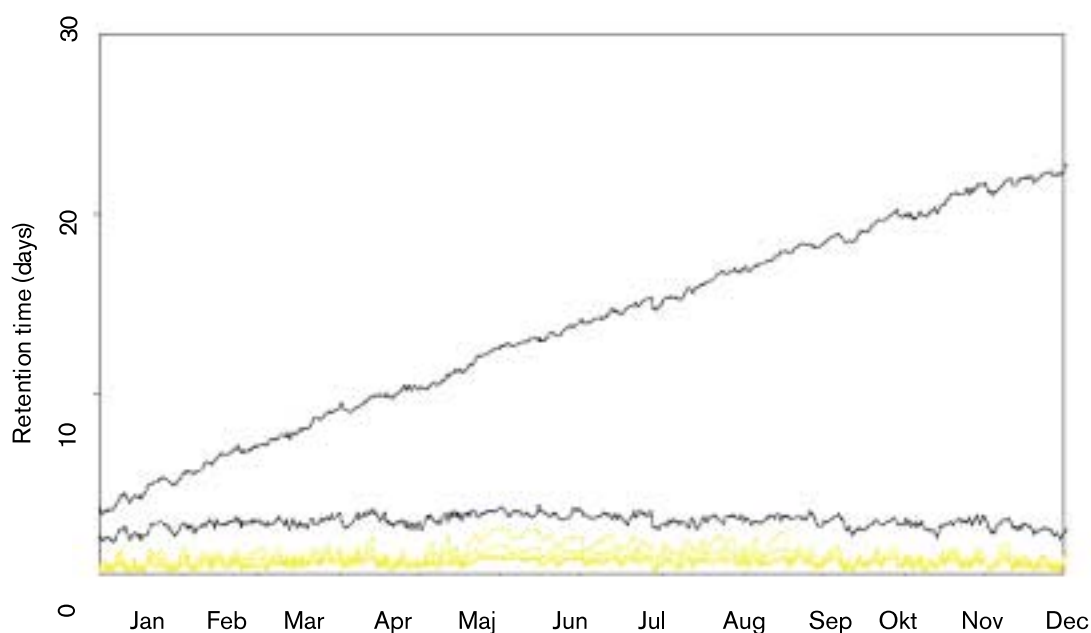

Figure 7-6. The retention time (days) for different levels of the local model area over a one-year period predicted for the year 4,000 AD. The different layers of the nominal run are given in yellow and the top and bottom layers of the land-rise regime are given in black /Engqvist and Andrejev, 1999/.

Changes induced by permanent ice cover

The simulation of a permanent ice cover regime is carried out by reducing the wind speed by 90% when the surface temperature reaches 0.2°C and below. When the temperature is further lowered to 0.0°C, the vertical heat exchange with the atmosphere is shut off. Table 7-4 shows the monthly averages of the differential retention time (days) relative to the nominal run for the permanent ice cover regime.

The elimination of the heating and cooling surface processes reduces the water circulation in two ways. First, the differential warming and cooling between the shallower and deeper areas are virtually eliminated. These processes drive the local thermally induced baroclinic horizontal currents. Thus, the retention time is increased relative to the nominal case during spring and autumn. Secondly, the summer stagnation situation does not occur, leading to increased retention time relative to the nominal case during the summer. Figure 7-7 shows only a small remaining circulation in Öregrundsgrepen, caused mainly by baroclinic effects. In the local model area, the only remaining movement-inducing forces are the reduced local wind and the much reduced densimetric fluctuations on the Baltic border driving a substantially weakened intermediary circulation. Figure 7-8 shows that seasonal variations have more or less ceased for the local model area.

Table 7-4. The monthly averages of differential retention time (days) relative to the nominal run for the permanent ice cover regime and the different depth layers of Öregrundsgrepen and the local model area.

Month	ÖG Depth (m)										Local Model Area, Depth (m)			
	1	5	10	15	20	25	31	40	50	60	1	5	10	15
1	13.21	13.74	13.48	12.59	11.22	12.93	14.17	15.14	20.52	15.34	0.507	0.605	1.098	1.486
2	12.23	12.91	13.20	12.97	11.44	12.36	13.43	14.40	20.24	19.55	0.360	0.465	0.968	1.516
3	10.49	11.10	11.28	11.00	9.23	10.08	11.73	13.46	25.43	20.02	0.263	0.404	0.926	1.415
4	7.87	8.34	8.77	9.16	7.72	8.52	10.19	12.57	37.68	28.69	0.268	0.394	0.995	2.173
5	4.98	5.06	4.22	4.39	4.42	6.06	7.92	10.44	32.19	37.18	0.168	0.280	0.704	1.596
6	-5.28	-5.22	-5.52	-4.50	-3.37	-0.81	2.30	6.16	-0.92	11.39	0.079	0.152	0.381	0.982
7	-0.91	-1.12	-2.17	-2.15	-2.14	-1.02	1.46	5.18	-2.93	-3.70	0.191	0.283	0.578	1.290
8	3.32	3.26	2.07	1.74	2.01	3.31	5.02	7.15	7.67	5.76	0.194	0.304	0.575	1.299
9	3.06	2.86	1.60	0.83	-0.06	-0.46	0.01	1.64	3.12	2.88	0.230	0.316	0.619	1.616
10	6.04	5.88	4.79	4.50	4.70	6.52	7.69	9.42	17.22	24.78	0.278	0.371	0.769	2.000
11	6.35	6.02	4.75	4.45	4.95	7.28	8.92	10.88	20.05	31.64	0.316	0.448	0.887	2.167
12	8.44	7.87	6.11	5.37	5.54	8.03	9.70	11.53	21.01	32.51	0.422	0.541	0.979	2.268
Avg.	5.82	5.89	5.22	5.03	4.64	6.07	7.71	9.83	16.77	18.84	0.273	0.380	0.790	1.651

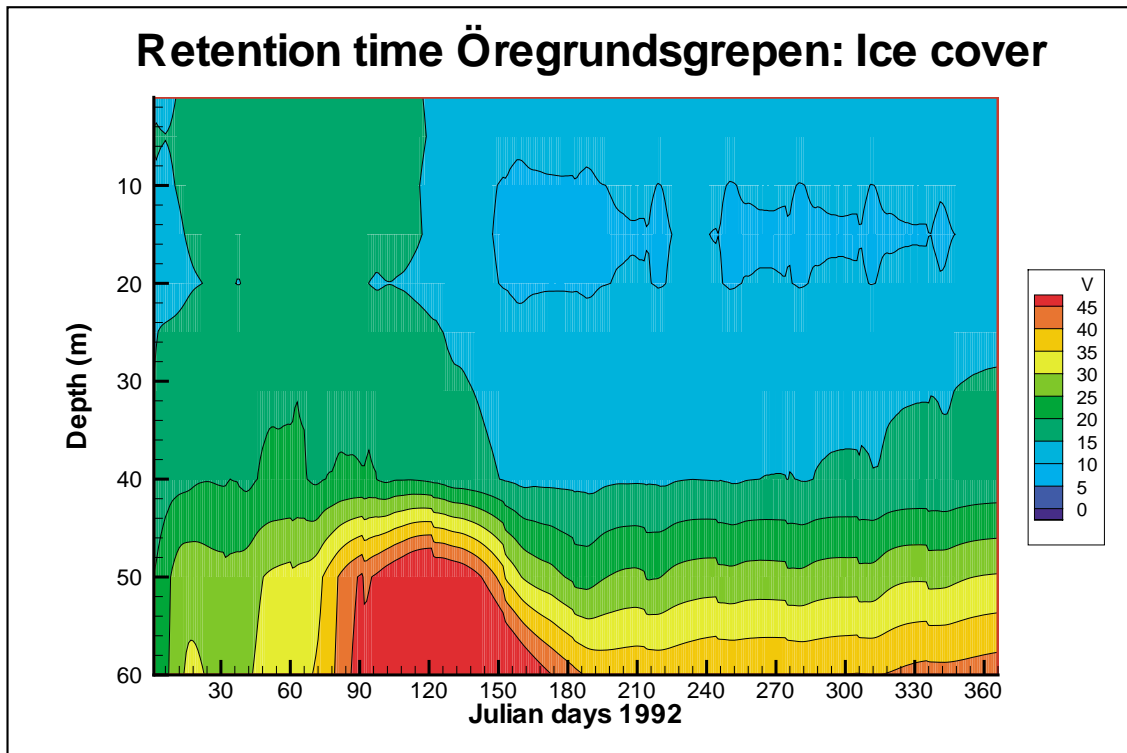

Figure 7-7. The volume retention time (days/m^3) at different levels of Öregrundsgrepen over a one-year period with permanent ice cover /Engqvist and Andrejev, 1999/.

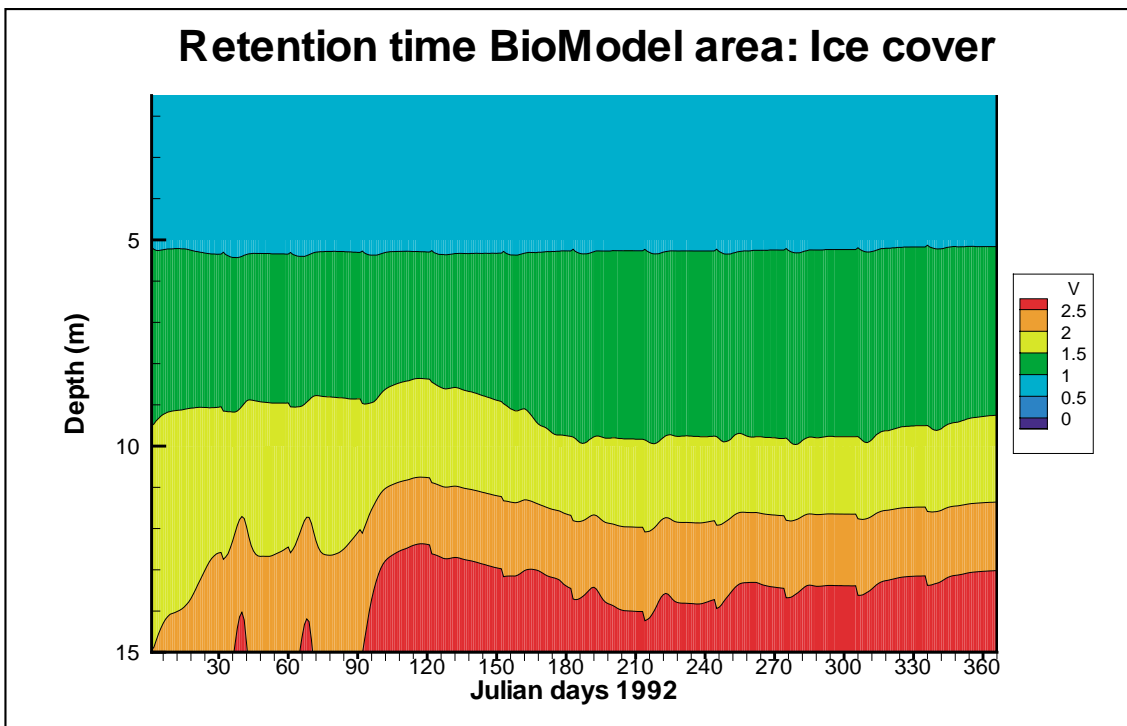

Figure 7-8. The volume retention time (days/m^3) at different levels of the local model area over a one-year period with permanent ice cover /Engqvist and Andrejev, 1999/.

7.4 References

Engqvist A, 1997. Water exchange estimates derived from forcing for the hydraulically coupled basins surrounding Äspö island and adjacent coastal water. SKB TR 97-14, Svensk Kärnbränslehantering AB

Engqvist A, Andrejev O, 1999. Water exchange of Öregrundsgrepen – A baroclinic 3d-model study. SKB TR 99-11, Svensk Kärnbränslehantering AB

Engqvist A, Andrejev O, 2000. Sensitivity analysis with regard to variations of physical forcing including two hydrographic scenarios for the Öregrundsgrepen – A follow-up baroclinic 3D-model study. SKB TR 00-01, Svensk Kärnbränslehantering AB

Påsse T, 1997. A mathematical model of past, present and future shore level displacement in Fennoscandia. SKB TR 97-28, Svensk Kärnbränslehantering AB

Sjöberg B (ed.), 1992. Hav och kust: Sveriges Nationalatlas. Almqvist & Wiksell International, Stockholm, 128 p.

8 Salinity

The salinity affects the species distribution in the ecosystem, the water turnover in surface waters and groundwaters and the chemistry of the water. Information about salinity comes from several reports /Engqvist and Andrejev, 1999; Engqvist and Andrejev, 2000; Gustafsson, 1997; Gustafsson et al., in manus; Westman et al., 1999/.

8.1 Today

8.1.1 Baltic Sea

Because of the large freshwater supply and the limitation of the water exchange, due to shallow sills and channels with large frictional resistance in the Öresund and the Belt Sea, the surface salinity is only 7‰–8‰ in the Baltic proper and even less in Bothnian Sea, the Bothnian Bay and the Gulf of Riga. The halocline of the Baltic proper is located at about 60 m depth, below which the salinity increases to 11‰–13‰.

The salinity change in the Baltic Sea during the last 8,500 years has been modelled by /Westman et al., 1999/. The model has been used to gain an understanding of the processes which affect the present day salinity, and will be used to develop a model to predict the future salinity /Gustafsson et al., in manus/.

The water exchange through the Danish Sounds is very important for the hydrographic conditions in the Baltic Sea. The net water flow through the Sounds is equal to the net freshwater supply to the Baltic drainage basin, i.e., about 16,000 m³/s. However, the instantaneous flows across the sills are an order of magnitude greater. The variability of the flows is of crucial importance for the effective salt transport across the sills. The Belt Sea and Öresund are usually very strongly stratified because of the large supply of low saline water from the Baltic Sea and supply of highly saline waters from the Kattegat for the lower layers. The momentary conditions in the vicinity of the sills are strongly dependent on the direction, magnitude and duration of the flow.

/Engqvist and Andrejev, 1999/ have modelled the surface salinity of the Baltic as part of their study of water turnover in Öregrundsgrepen. The plots of surface salinity for three occasions during the modelled year are shown in Figure 8-1.

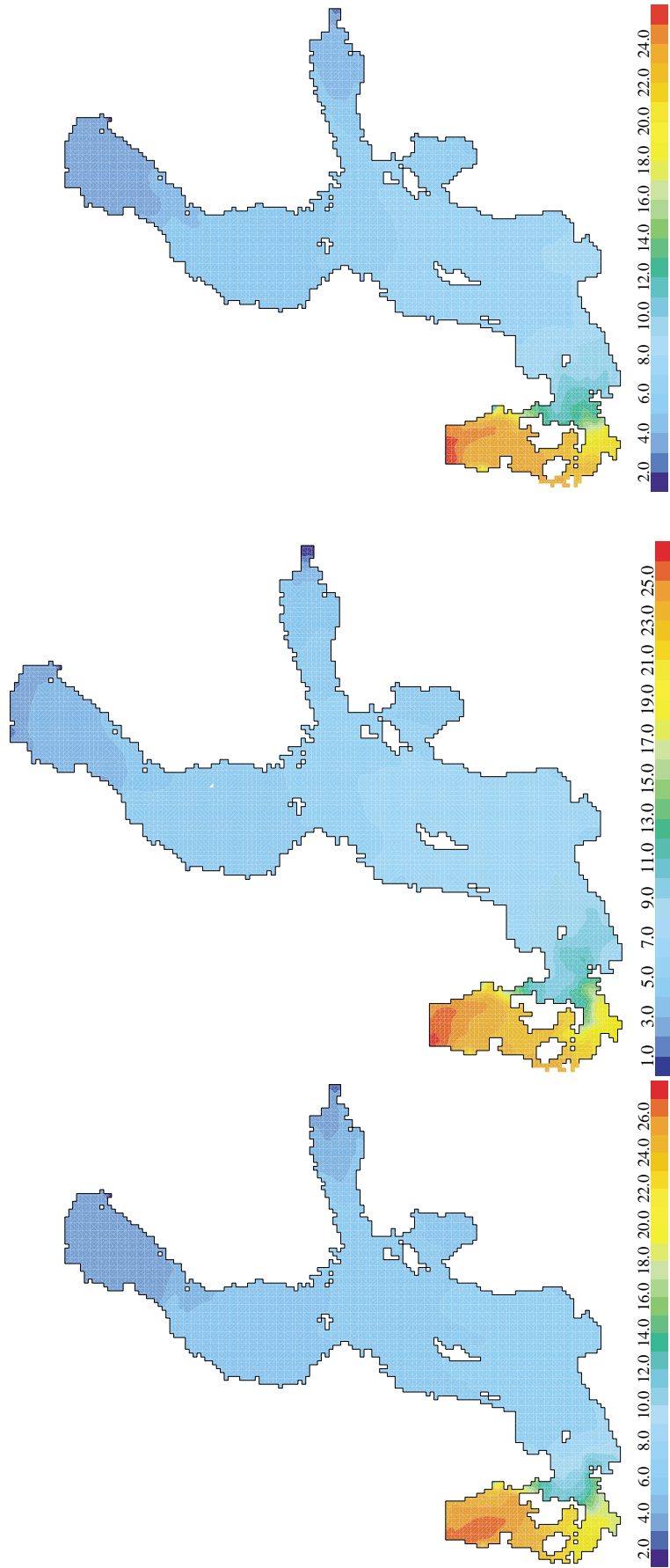

Figure 8-1. Modelled surface salinity distribution of the Baltic model 1992-01-01 (a), 1992-06-30 (b), 1992-12-31 (c) /Engqvist and Andrejev, 1999/.

8.1.2 Öregrundsgrepen

The salinity in Öregrundsgrepen in 1977–78 was between 4.5–5.8‰ in surface water and 5.6–6.4‰ at a depth of 40 m. A monthly mean from twenty years (1971–1991) salinity measurements in Åland Sea shows a variation of only 0.5‰. The salinity in Åland Sea is somewhat higher and more stable compared to Öregrundsgrepen. During the winter period when Öregrundsgrepen can be ice-covered, the salinity can decline to less than 1‰ in the surface water layer because fresh water from the ice accumulates.

The surface salinity of Öregrundsgrepen was modelled by /Engqvist and Andrejev, 1999/ and is shown in Figure 8-2. The salinity depletion at the mouth of Kallriga bay, where two streams discharge is clearly visible. Except for this, the salinity surface distribution is homogeneous. A cross sectional picture of salinity (Figure 8-3) shows that the vertical gradients in Öregrundsgrepen are feeble.

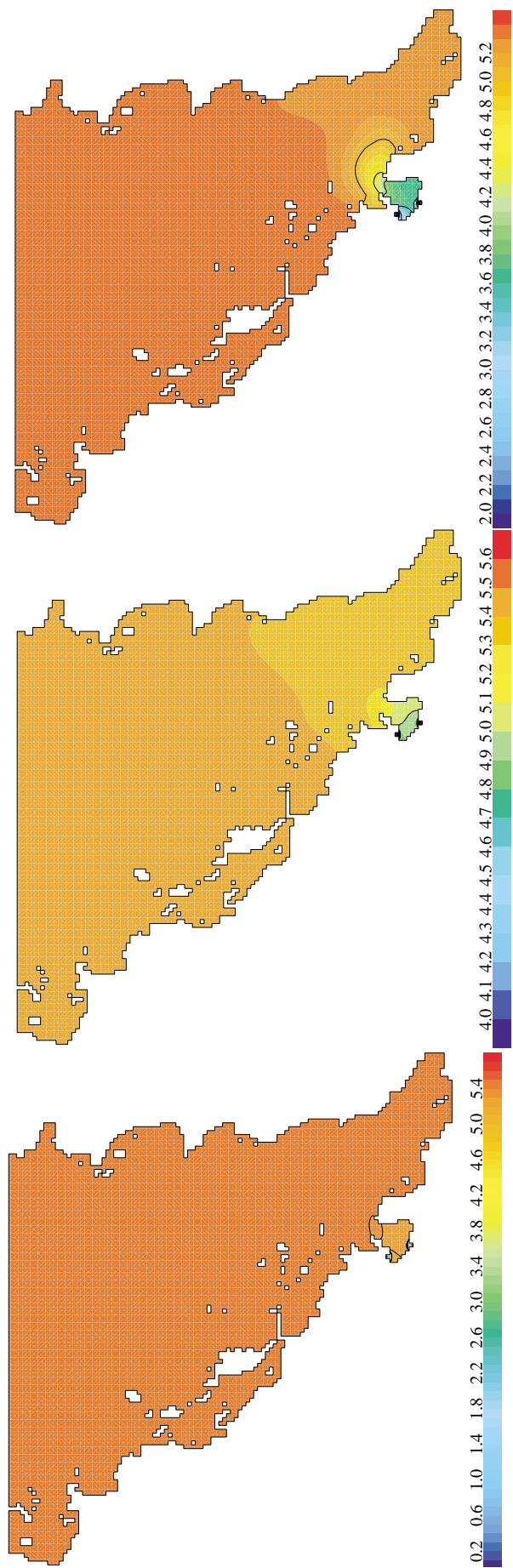

Figure 8-2. Modelled surface salinity distribution of the ÖG area model 1992-01-01 (a), 1992-06-30 (b) and 1992-12-31 (c) /Enqvist and Andrejev, 1999/.

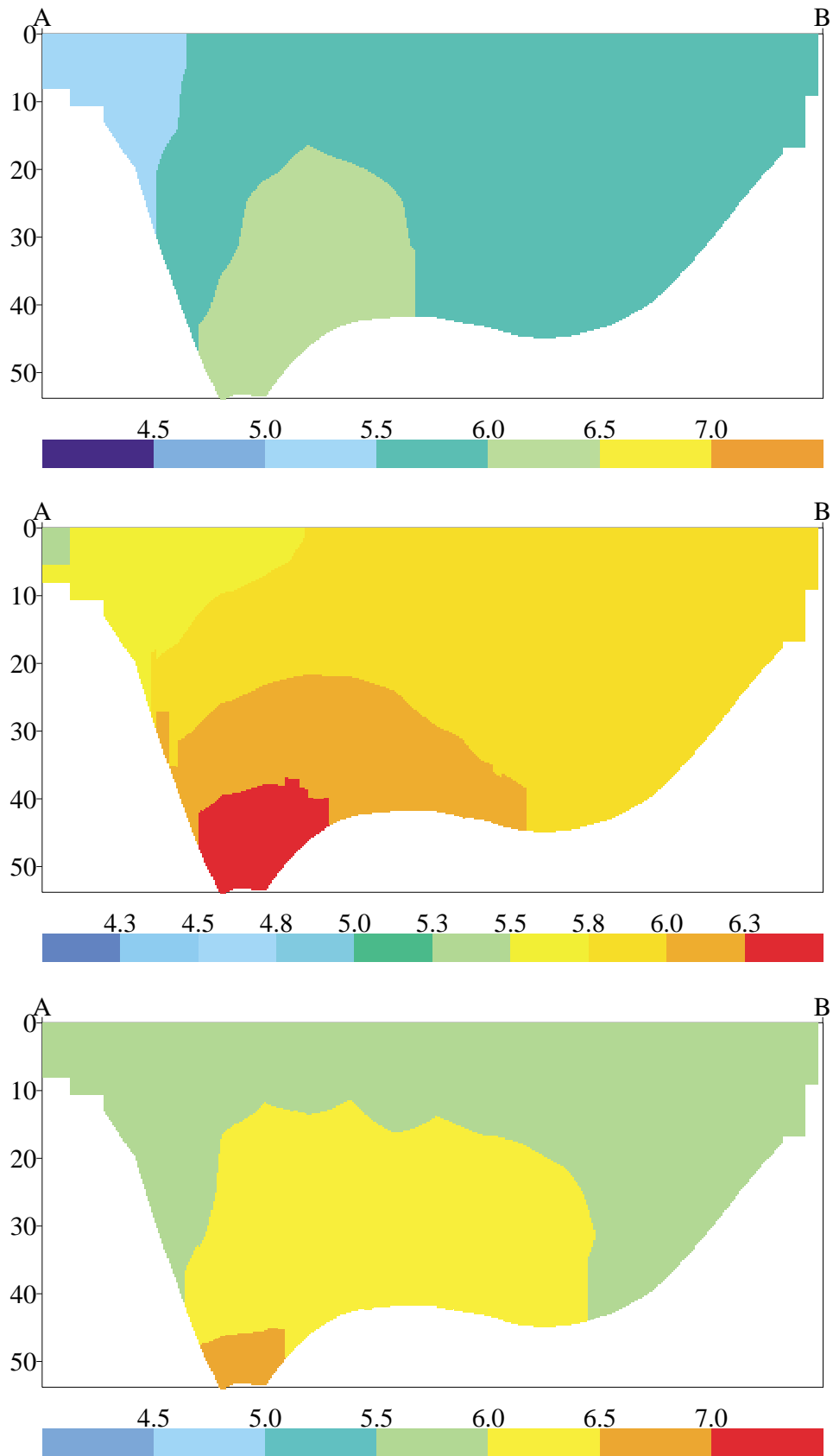

Figure 8-3. Modelled vertical salinity distribution in a cross-section 1992-01-01 (a), 1992-06-30 (b) and 1992-12-31 (c). The approximate location of this cross-section is indicated in Figure 4-1 /Engqvist and Andrejev, 1999/.

8.2 Future development

8.2.1 Baltic Sea

The vertical structure of the Baltic Sea salinity is strongly dependent on saline-water inflow, freshwater inflow and turbulent mixing. Change in any of the factors can thus have a large impact on the vertical stratification. For example with an increased inflow of ocean water the halocline depth could easily decrease, forcing the Baltic Sea towards conditions similar to the Skagerrak or the Hudson Bay, with a thin brackish layer over a deeper saline layer. At the other extreme, with very reduced inflows, the Baltic Sea could become a lake with negligible salinity. The sensitivity of the Baltic Sea surface salinity to changes in freshwater inflow, wind and sea level fluctuations in the Kattegat are shown in Figure 8-4. A 20% change in freshwater inflow has a strong impact on the surface salinity.

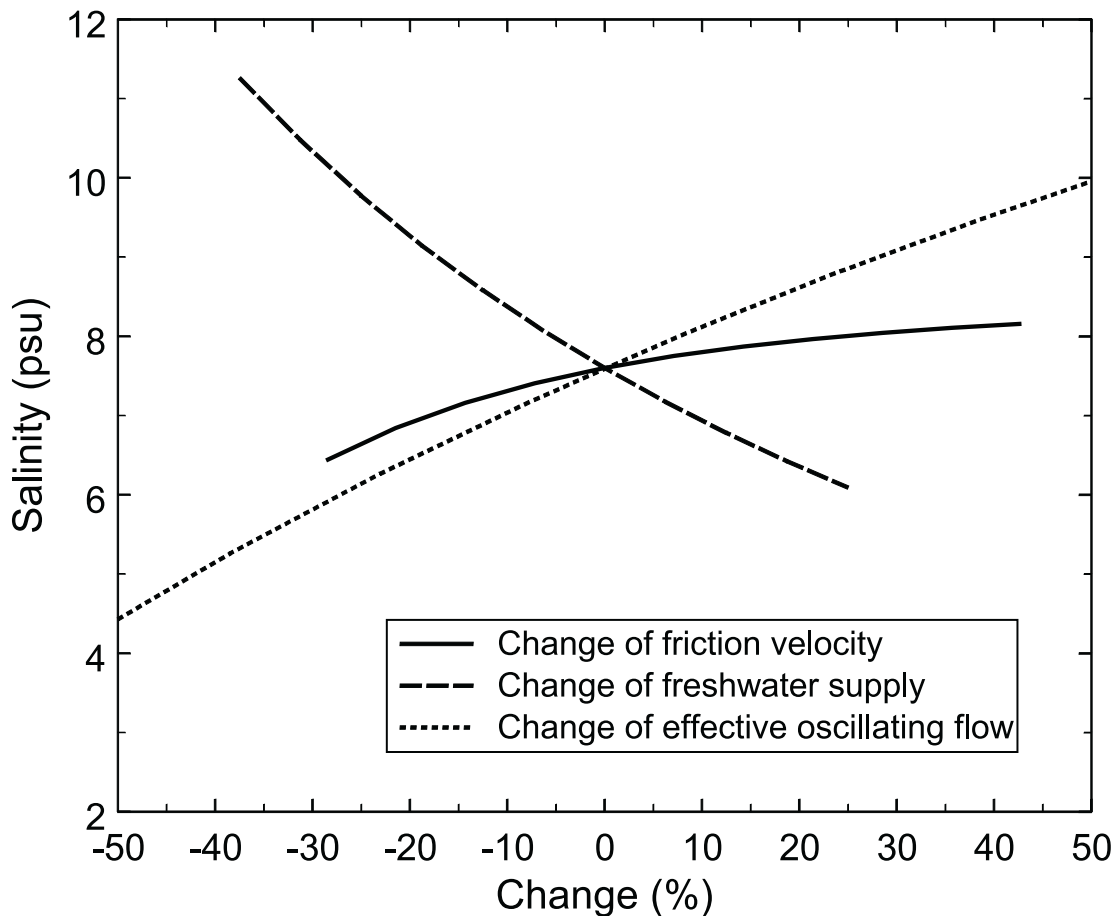

Figure 8-4. Model results for the response of Baltic Sea salinity with respect to changes in wind stress (solid line), freshwater input (dashed line) and effective flow oscillations (dotted line) /Westman et al., 1999/.

/Westman et al., 1999/ have developed a model to describe the importance of changes in the cross-section areas of the Öresund strait and the Darss sill compared to direct climatic influences (temperature and net freshwater input). A steady-state model for the salt exchange between the Baltic Sea and Kattegat /Gustafsson, 1997/ has been used to study past changes of salinity during the Holocene. The model will be used to study future development of the salinity of Baltic Sea.

According to the model used, the salinity variations during the last 8,500 years can be explained by the changes in cross-section areas of the inlets together with a variation in net freshwater input (compared to the present value) between 15% (if the maximum salinity of 10‰ is assumed) and 60% (if a maximum salinity of 15‰ is assumed).

8.2.2 Öregrundsgrepen

/Brydsten, 1999/ has modelled the shore displacement of Öregrundsgrepen. The modelling shows that from about 4,500 AD the sea in the area consists of a long and narrow bay (see Figure 5-5). During this period it is likely that the sea in the model area has pronounced estuarine environment, i.e. low salinity, a sharp developed halocline, an estuarine water circulation and a sedimentation that is controlled by this water circulation.

8.3 References

Brydsten, L, 1999. Shore level displacement in Öregrundsgrepen.
SKB TR-99-16, Svensk Kärnbränslehantering AB

Engqvist A, Andrejev O, 1999. Water exchange of Öregrundsgrepen – A baroclinic 3d-model study.
SKB TR 99-11, Svensk Kärnbränslehantering AB

Engqvist A, Andrejev O, 2000. Sensitivity analysis with regard to variations of physical forcing including two hydrographic scenarios for the Öregrundsgrepen – A follow-up baroclinic 3D-model study.
SKB TR 00-01, Svensk Kärnbränslehantering AB

Gustafsson B, 1997. Interaction between Baltic Sea and North Sea.
Deutsche Hydrographische Zeitschrift, 49: 165–183.

Gustafsson B, Omstedt A, Westman P, Wastegård S, Schoning K, in manus. Salinity change in the Baltic Sea in the future (prel.).
SKB TR-xx-xx, Svensk Kärnbränslehantering AB

Westman P, Wastegård S, Schoning K, Gustafsson B, Omstedt A, 1999. Salinity change in the Baltic Sea during the last 8500 years: evidence, causes and models.
SKB TR-99-38, Svensk Kärnbränslehantering AB

9 Coastal area

Several studies of the aquatic ecosystem have been performed in Öregrundsgrepen mainly due to the building of the nuclear power plant and the work with the biotest basin. The results relevant to the SAFE study are reviewed in /Isaeus, 1998/. Some new surveys have also been made for the SAFE project /Kautsky et al., 1999/. The results have then been compiled as a model of the carbon dynamics in the local model area, /Kumblad, 1999, 2001/. If no other references are given in the text below, the sources are from the reports mentioned above or cited in these reports.

9.1 Ecosystem structure, present day

The biosphere of today in the local model area is a brackish water coastal ecosystem, which is part of Öregrundsgrepen. The local model area will be the recipient for hypothetical future discharges of radionuclides at least for the next 3,000 years. The major point from the existing body of knowledge are described below and a summary of the dominating carbon flows and carbon reservoirs is compiled.

9.1.1 The pelagic community

The pelagic community embraces the water mass with phytoplankton, bacterioplankton, zooplankton and fish. During the spring the phytoplankton community in Öregrundsgrepen is dominated by diatoms (*Bacillariaophyceae*) and dinoflagellates (*Dinophyceae*) while the biomass in summer and autumn mainly is composed of bluegreen algae (*Cyanophyceae*) and small flagellates.

The zooplankton community is low of diversity since *Acartina bifilosa* and *Eurytemora affinis*, both copepods, constitute about 80% of the zooplankton biovolume. The rest is composed of cladocerans, mainly the genera *Bosmina spp*, *Podon spp* and *Evadne spp*, rotatorians with the genera *Keratella spp* and *Synchaeta spp*, ciliates with both *Tintinnida* and naked forms, and also different larvae stages of benthic animals.

9.1.2 Bottom vegetation

On shallow soft bottoms the vegetation is dominated by vascular plants. In Forsmarksfjärden, west of the Biotest basin, vascular plants like *Myriophyllum spicatum* and different species of *Potamogeton spp*. were common in a survey performed in 1974. *Chara tomentosa* and/or *Potamogeton pectinatus* can be dominating down to a depth of two meters in the shallow bays, which have limited water exchange with the sea. *Chara baltica* and *Najas marina* often form small stands on the bottoms of the shallow bays. In places where the sediments are more stable *Chara marina* is usually found, and on sandier sediment the diversity can be great and include many vascular plants like *Potamogeton pectinatus*, *P. perfoliatus*, *Ranunculus baudotti*, *Zanichellia palustris*,

Myriophyllum spicatum and *Callitriche spp.* Some of the Charophytes found in these areas are redlisted and occur on the list of species in Sweden that need to be protected.

At depths of 2–4 m the soft bottoms often are covered by *Vaucheria spp.* On these bottoms sparse stands of *Potamogeton perfoliatus*, *Myriophyllum spicatum* and *Ranunculus baudotti* can also be found.

The occurrence of macrophytes was verified by a diving survey /Kautsky et al., 1999/.

On the hard, more stable substrates (boulders, rock) a luxuriant growth of the bladder wrack (*Fucus vesiculosus*) could be seen. Also, the moss *Fontinalis dalecarlica* was common. The average plant biomass in the local model area for different depth intervals is shown in Figure 9-1. The filamentous green algae (*Cladophora spp*) dominate the first two meters and some filamentous brown algae (*Ectocarpus/Pilayella* and *Sphacelaria arctica*) also occur. Between 2 to 4 m the bladder wrack (*Fucus vesiculosus*) dominates the biomass (totally 214 gDW m⁻²). Vascular plants (*Potamogeton spp* and *Zostera spp*) as well as perennial redalgae (*Furcellaria lumbricalis*) also contribute to the total biomass. Perennial redalgae dominate the vegetation from 4 to 10 m depth. Deeper down vegetation is scarce.

Compared to the results from studies of nearby areas, the maximum value of biomass was lower, 214 g/m² compared to 580 g/m². This is probably due to the lack of suitable substrate in the area.

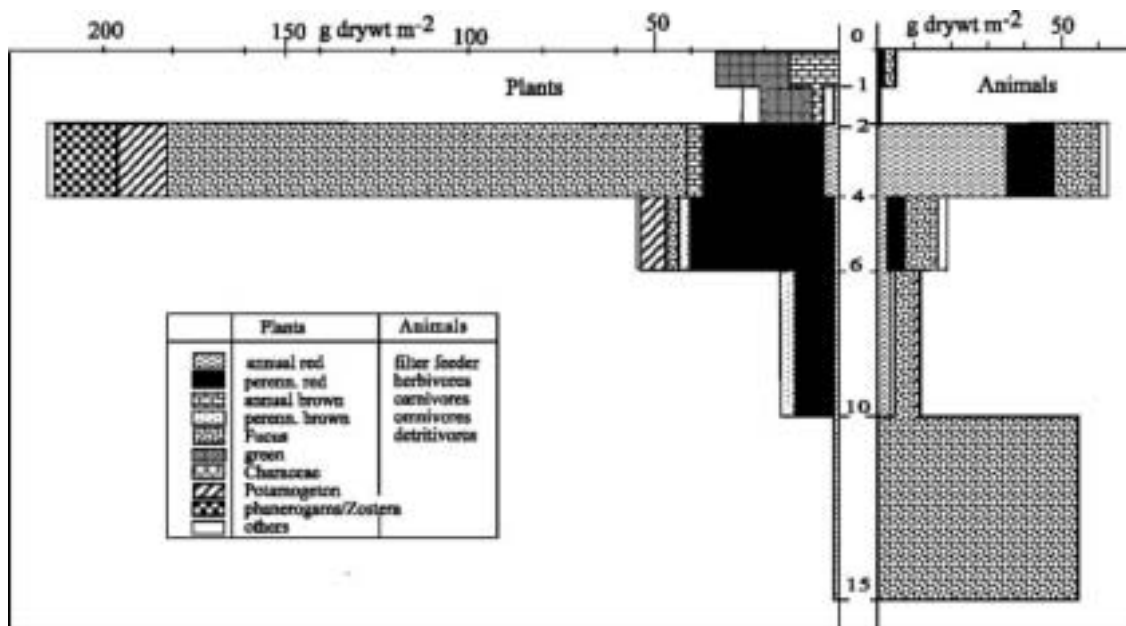

Figure 9-1. The average depth distribution of benthic biomass in the local model area at SFR from /Kautsky et al., 1999/.

9.1.3 Bottom fauna

The diving survey visited the bottom from the surface down to maximally 18 m in the local model area. Both the biomass and diversity peak at depths from 2 to 4 m (mean biomass 60 gDWm⁻²) with a high contribution of filter feeders (mainly *Cardium spp*), herbivores (*Theodoxus fluviatilis* and *Lymnaea peregra*) and detritivores (mainly *Macoma balthica*). Deeper, the detritivores dominate (mainly *Macoma balthica*), with a high biomass down to 15 m. The blue mussel (*Mytilus edulis*) was to a large extent missing, although suitable substrate was present. In the Bothnian Sea blue mussels extend up to the Northern Quark, but usually few individuals are found at each site along the coast and never at the densities that can be observed further south in the Baltic proper.

9.1.4 Fish

The most common species of fish in Öregrundsgrepen are herring, roach and perch, followed by ruffe, smelt, fourhorn sculpin, sprat and cod. Other species that occur in the Öregrundsgrepen are for instance pike and eel. With the fishing method used it was not possible to monitor small sized species e.g. three-spined stickleback, sand goby, common goby, bleak and minnow, which may have affected the results of fish species distribution. The distribution of the most abundant species is reported in Table 9-1.

9.1.5 Birds and seals in the area

The area offers good conditions for sea birds. The most common birds are goldeneyes, tufted ducks, gooseanders, mute-swan, mallards and eider-ducks. The sea eagle is also a frequent visitor in the area. Seals are occasional visitors in Öregrundsgrepen.

Table 9-1. The distribution of fish species in the study area (% of the total catches in gill nets) presented in /Kumblad, 1999/.

Herring	Roach	Perch	Ruffe	Smelt	Others
78.0	10.0	4.7	3.0	1.7	2.6

9.2 Ecosystem function

In the work by /Kumblad, 1999, 2001/ the coastal ecosystem model of the area around SFR was compiled from various data sources (see above) and estimates made for the local model area (Figure 4-2) based on hypsographic information (Table 5-2). The total standing stocks and flows of carbon are shown in Figure 9-2.

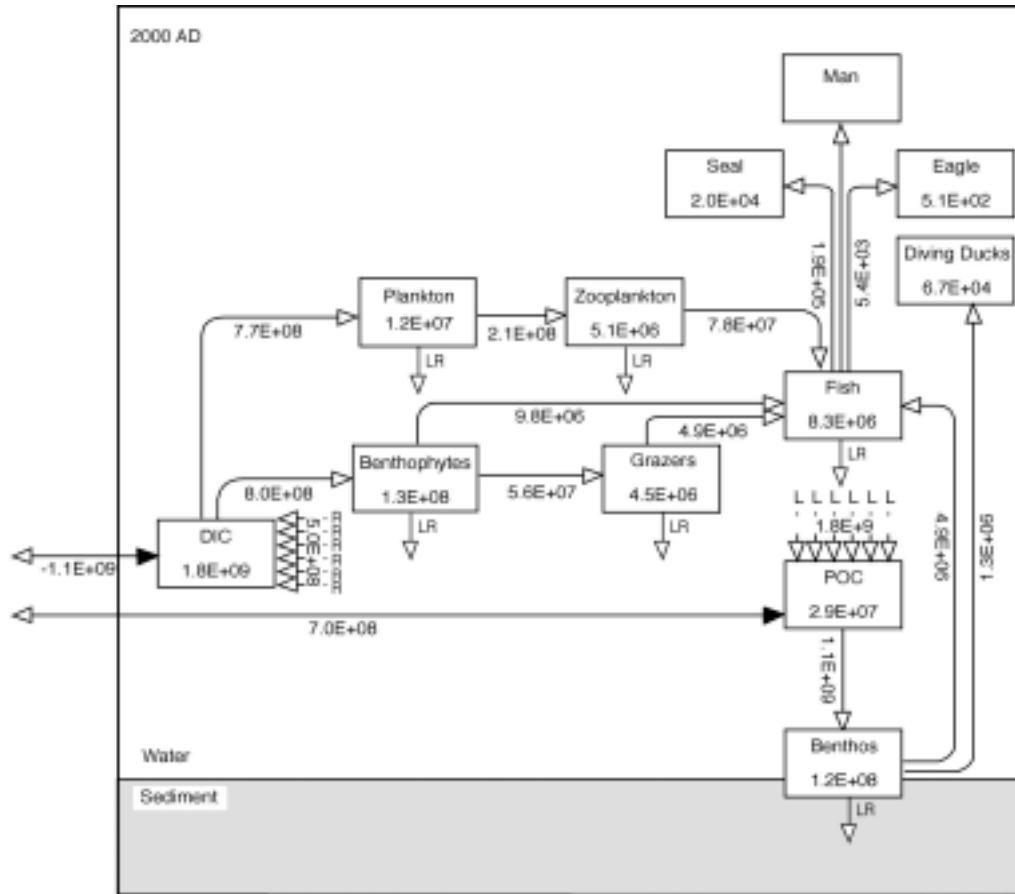

Figure 9-2. Annual standing stocks and flux of carbon (gC and gC/year) in the study area at 2,000 AD. R = respiration, L = loss (i.e. primary production or consumption – respiration – predation) /Kumblad, 2001/.

The carbon budget was based on masses and flows of carbon between eleven functional groups (including POC and DIC) in the ecosystem above SFR and the results indicate that the organisms are self-sufficient in carbon and that the area exports carbon corresponding to approximately 35% of the annual primary production. The largest organic carbon pool is DIC and the major functional organism groups are the macrophytes (37% of the total biomass), benthic macrofauna (36%), and the microphytes (11%). The soft bottom and phytobenthic communities seem to have important roles in the ecosystem since these communities comprise the main part of the living carbon in the studied area.

The phytobenthic community contributes to the larger share (70%) of the primary production whereas the larger part of the consumption is taken part in the soft bottom community (49%).

9.3 Future development

In Chapter 5 the effects of the shoreline displacement on the extension of the coastal area are shown. The future development gradually shrinks the coastal ecosystem within the modelling area and finally at about 4,900 AD a large lake in the modelling area is isolated from the sea. In these sequences one case of a future ecosystem, at 4,000 AD, was selected and argued to be a critical but still representative stage, and presented below.

2,000 AD–3,000 AD

During the first 1,000 years the changes in the coastal ecosystem in the model area and in Öregrundsgrepen are limited. The water surface area is reduced by approximately 20% and the maximum depth is about 12 m at the end of this period. This will give a small change in the water turnover time for the area (cf. Chapter 7). The accumulation bottoms increase from 20 to 40%. The resulting changes in total biomass are limited, because even at 4,000 AD (see below) the changes are quite small.

3,000 AD–4,900 AD

The continuing shore line displacement will result in the start of development of terrestrial vegetation in areas formerly covered by water (see Chapter 10). At the end of this period the coastal area shrinks to an enclosed archipelago, which eventually is isolated and develops to lakes (c.f. Chapter 11). The area of water surface in the local model area is reduced by about 50% and the water volume by about 90%. The water-turnover time increases to about 13 days in the model area (c.f. Chapter 5, 7). This affects the distribution of the marine biomass. /Kumblad, 2001/ has estimated the future coastal ecosystem at 4,000 AD (Figure 9-3).

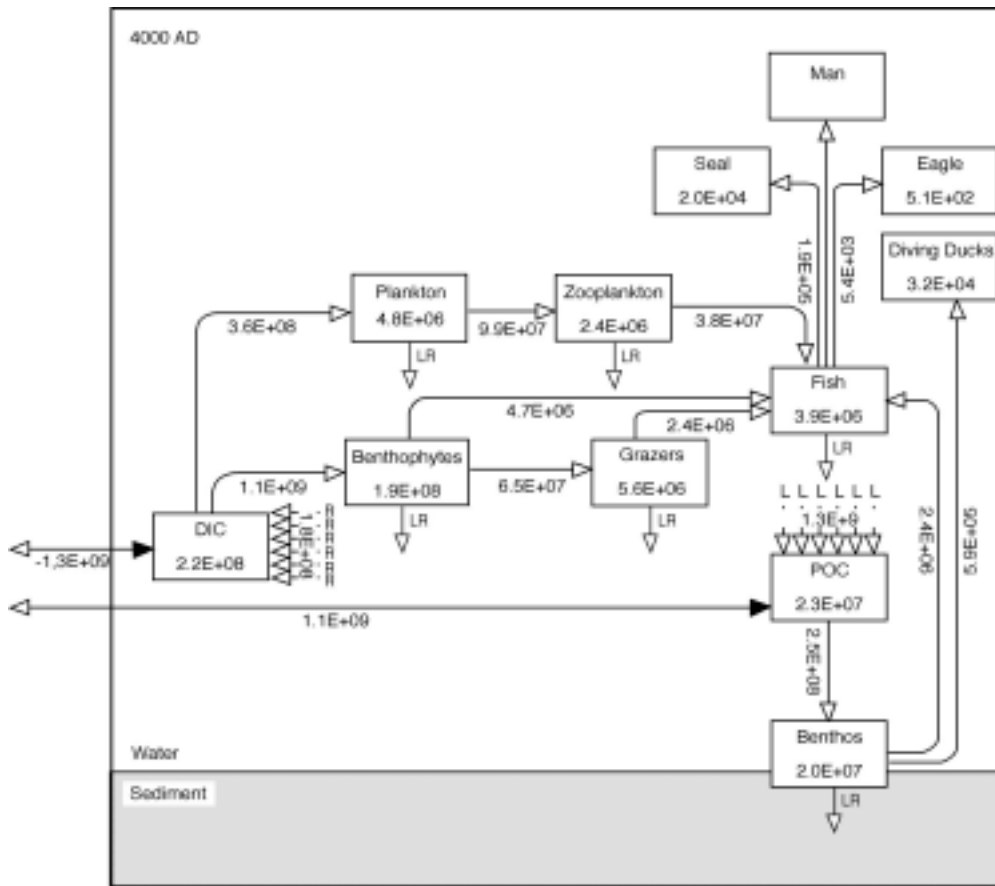

Figure 9-3. Annual standing stocks and flux of carbon (gC and gC/year) in the study area at 4,000 AD. R = respiration, L = loss (i.e. primary production or consumption – respiration – predation) /Kumblad, 2001/.

The total biomass decreases by 20% from year 2,000 AD to 4,000 AD due to decreased water surface in the future area. Since the water at 4,000 AD will be shallower than at present, the area of the photic zone will increase, even though the total area decreases, which results in increased dominance of benthic plants and grazers at the cost of benthic consumers such as benthos. The biomass of benthophytes and grazers increases almost 50% and 25% respectively while benthos decreases almost 80%. However, the species are assumed to be the same as today.

The turnover of matter in the model area will change. The total primary production increases by almost 10% due to higher benthophyte biomass and the decomposition is reduced by approximately 80% as a consequence of decreased benthos biomass. This may result in a larger export of excess production from the area at 4,000 AD compared to 2,000 AD but probably also in an increased sedimentation of organic matter due to the slower water exchange rate that is expected in the future ecosystem.

In total this means a higher retention of organic matter in the coastal area at 4,000 AD compared to today. Which means that radionuclides associated to organic matter will be buried in the sediment to a larger extent than at present.

9.4 References

Isaeus M, 1998. Description of the brackish environment in the Forsmark area.
SKB PR-U-98-15, Svensk Kärnbränslehantering AB

Kautsky H, Plantman P, Borgiel M, 1999. Quantitative distribution of aquatic plant and animal communities in the Forsmark area.
SKB R-99-69, Svensk Kärnbränslehantering AB

Kumblad L, 1999. A carbon budget for the aquatic ecosystem above SFR in Öregrundsgrepen.
SKB R-99-40, Svensk Kärnbränslehantering AB

Kumblad L, 2001. A transport and fate model of C-14 in a bay of the Baltic Sea at SFR. – Today and in the future.
SKB TR-01-15, Svensk Kärnbränslehantering AB

10 Surrounding land

This chapter is a summary of information found in the reports /Jerling et al., 2001/, /Spangenberg and Eriksson, 2000/.

The surrounding land, i.e. the Forsmark area, comprises large areas of wetland and coniferous forest on moraine. The area is situated on the border of two different landscapes: forests typical of this part of Sweden and the coasts and archipelagos of the Baltic Sea. The calcareous moraine is an important contribution to the rich flora and calcareous influenced Chara-lakes. The soils on the flat peneplain are naturally rich in nutrients, but the soils in the areas closer to the coast are thinner, supporting less agricultural activity.

The coastline, including the archipelago, is about 400 km. The topography on the islands is also very flat. The largest island is Gräsö. The shore displacement in this area is of great importance and leads to the occurrence of special wetlands connected with the land uplift; fen affected by the topography and the sea shore.

10.1 Present

A vegetation map of the SFR area has been prepared by /Jerling et al., 2001/ and is shown in Figure 10-1. The vegetation in the SFR area was assigned to four main classes, each class being further subdivided as follows:

- | | | | |
|---|--------------------|------------------------|------------------------|
| 1 | Coniferous forests | a) > 70% tree cover | b) < 70% tree cover |
| 2 | Mixed forests | a) > 70% tree cover | b) < 70% tree cover |
| 3 | Deciduous forests | a) > 70% closed canopy | b) < 70% closed canopy |
| 4 | Open grassland | a) dry to moist | b) moist to wet |

In addition, rocky outcrops, gravel and excavated masses are indicated as well as bitumen coated roads and parking areas.

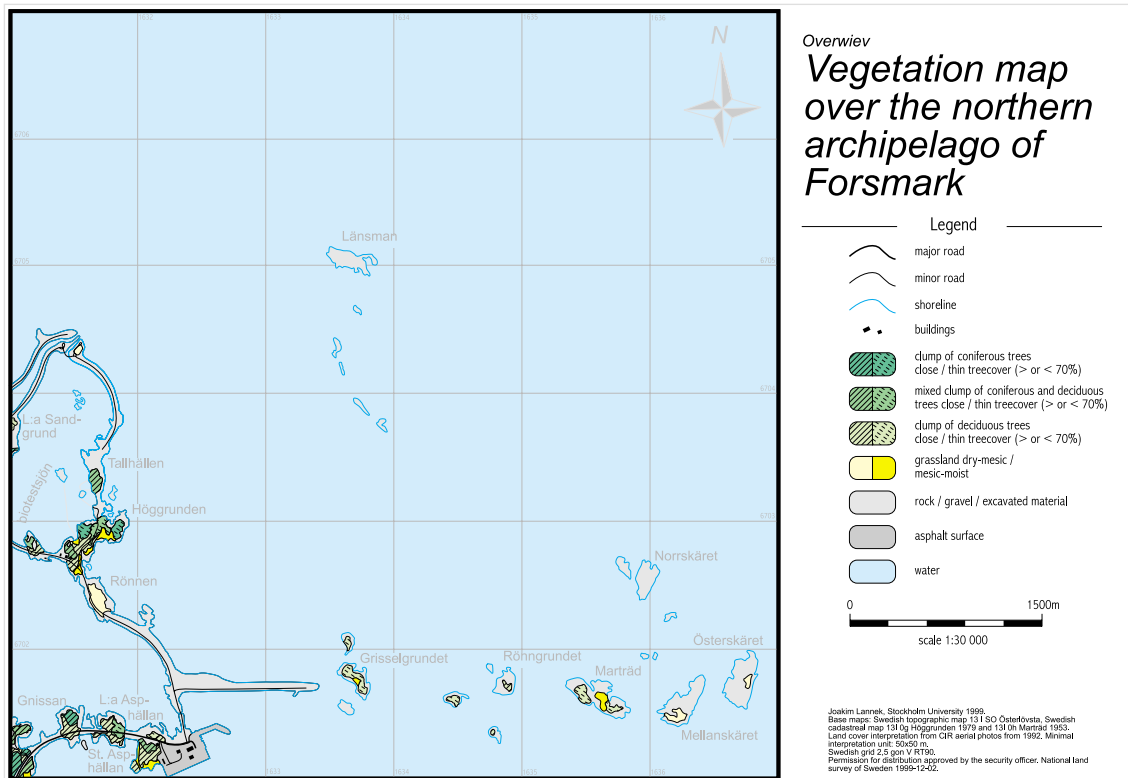

Figure 10-1. Vegetation map of present time for the northern archipelago of Forsmark area /Jerling et al., 2001/.

The present vegetation shows a clear spatial vegetation pattern with three zones from the west (inner) to the east (outer) archipelago: an inner dominated by pine (*Pinus sylvestris*) forest, an intermediate dominated by deciduous forests and an outer where exposed bedrock carrying few trees is most common. The larger islands, such as Gräsö, function as mainlands, making the pattern irregular in some places.

10.1.1 Land classes and vegetation description

The total area of Östhammar municipality is 2,790 km². The total area of land is 1,451 km² (52%), fresh water is 51 km² (2%) and the sea is about 1,287 km² (46%). Forests are the dominating land class with ca. 71%, fields 11%, pastures and meadows ca. 3% and the rest (impediment, urban areas and other land) is ca. 15%.

Forests

The most common forest type is the 70-year old pine forest, typical of broken terrain in eastern Svealand. The cover of forest trees in the region is pine (*Pinus sylvestris*) 40–60%, spruce (*Picea abies*) 20–40%, birch (*Betula pendula*) 10–20%, oak (*Quercus robur*) <1 and other broad-leaved trees 5–10%. Closer to the coast and the SFR-region the amount of pine decreases in favour of spruce. The most common undergrowth is the nutrient rich herb type, which is often found in calcareous areas. Some 25–50% of the

undergrowth in the SRF-region is of this rich herb type, but it decreases further inland to ca. 15–25%.

In general, the coniferous forests in the area often have a major element of deciduous trees and a shrubby undergrowth. In wetter areas the deciduous trees dominate, together with increasing amount of herbs and grasses. Pine forest is found on thin soils of rocky outcrops of bedrock. The shores are often bordered by alder (*Alnus glutinosa*), and sometimes ash (*Fraxinus excelsior*).

Agriculture

The amount of arable land has decreased over the years. Today Östhammar municipality has ca. 17,200 ha cultivated land and ca. 2,500 ha pastures and meadows. There are 550 farmers and four of them are defined as large companies, i.e. farms with more than 100 cattle units. There are no farms close to the SFR site.

The amount of semi-natural grasslands in the Forsmark region is today ca. 1% of the total land area. The forest grazing and grazing on the shore-meadows have almost totally ceased and the landscape is changing character with increased growth in accordance with the successional development. Where grazing still occurs, the intensity is low.

Wetlands

The Forsmark catchment area has a high percent of wetlands compared to Uppland in general. The wetlands are characterised by the calcareous post-glacial clay, which is a prerequisite for the high amount of rich-fens and extreme rich-fens in the area. The buffer capacity is good in ground water and lakes with pH levels >7.1. The Forsmark catchment is dominated by oligotrophic hardwater lakes, surrounded by mires. The characteristics and ontogeny of the lakes in the SFR-region are presented in Chapter 11.

Archipelago and shore meadows

The shore surrounding SFR is a “land uplift shore”, where new terrestrial areas are continuously emerging from the sea because of the shore level displacement. The flat moraine shores outside Forsmark are rich of calcareous rock ground/sediments, giving the islands a vegetation dominated by broad-leaved trees and thickly wooded vegetation. The islands in Kallrigafjärden are of botanical interest containing partly natural coniferous forests rich with deciduous trees and herb-rich undergrowth.

The small islands in the outer archipelago have a high degree of exposed bedrock and a vegetation strongly influenced by the guano from the birds, which favours specific lichen species (e.g. *Xanthoria parietina*, *Xanthoria candelaria* and *Ramalina sp.*). The rockiest shores are the outer limit for the green plants. Further inland the vegetation is more diverse, but because of the thin and poor soil several of the species that occur are drought resistant (e.g. Sea campion (*Silene uniflora*), Biting stonecrop (*Sedum acre*), Woad (*Isatis tinctoria*), Scentless mayweed (*Matricaria perforata*), Chives (*Allium schoenoprasum*). The rocky and sandy shores are often colonised by shrubs like Hawthorn (*Hippophaë rhamnoides*), which is an early colonising species in land uplift areas.

In the outer limit in the archipelago trees often form groups on patches of thicker substrate, e.g. birch, aspen (*Populus tremula*), rowan (*Sorbus aucuparia*), grey alder (*Alnus incana*) and pine. Behind this border of deciduous trees, pine forest develops where outcrops of bedrock occur. The pine forest only occasionally grows all the way down to the sea shore. Rock pools are a common element on the sea shores and form opportunities for species like Lesser Bulrush (*Typha angustifolia*), Bur reeds (*Sparganium sp.*) and certain bryophytes to exist. The species of plants and animals change due to salinity and nutrition conditions.

10.1.2 Fauna

The influence from the coast is of great importance for the wild fauna, especially for bird life and game. The coastal zoning creates a mosaic of small habitats which in turn give good conditions for high biodiversity.

The estimated population density of roe deer (*Capreolus capreolus*) and moose (*Alces alces*) in Uppsala county is 4 roe deer/km² and 0.7 moose/km² (winter population). None of the four species of large carnivores is now present in this part of Sweden. Mammals frequently occurring in the region are badger (*Meles meles*), beaver (*Castor fiber*), fox (*Vulpes vulpes*), hare (*Lepus sp.*), marten (*Martes martes*), mink (*Mustela vison*), moose (*Alces alces*) and roe deer (*Capreolus capreolus*).

The number of breeding bird species is very high in northern Uppland (185 species) and there are about 100 different bird species nesting in the Forsmark region.

The County Administration has established sanctuaries for birds and seals along the coast. There are 15 sanctuaries in Östhammar municipality and most of them are located far out in the archipelago.

10.1.3 Production and energy flow in terrestrial communities

In order to support future modelling studies of energy and carbon flows in the terrestrial communities in the area, /Jerling et al., 2001/ have estimated the net primary production and the carbon production in the SFR region. A small area (ca. 3.3 km²) south of Forsmark was chosen as the study area.

Table 10-1 shows the landclass distribution used by /Jerling et al., 2001/ to calculate the average production per m² in the study area. The values shown are based on literature studies and field observations of the coastal area.

These percentages are used to weight the net primary production and carbon production per m² for the different landclasses to obtain a production per unit area of the region studied (m²), the result of which is shown in Table 10-2.

Though the studied area has a higher percentage of forest and less agricultural area than Sweden in general the primary production in the study area (419 ton/km²) is higher than in the rest of Sweden (317 ton/km²).

Table 10-1. Land class distribution in the small study area.

Land use		% land area
Forest	coniferous	38
	deciduous	4.8
	mixed	4.9
	broadleaved	0.5
Clear Cut		13.6
Field		19.9
Meadow		10.9
Reed		0.9
Fen		0.8
Gravel pit		0.7
Bedrock		0.3
Lake		0.2
Settlements		4.4

Table 10-2. Total annual primary production per m² and its distribution in the study area and Sweden.

Land class	Annual net primary production		
	Study area (g dw/m ²)	Study area (g C/m ²)	Sweden (g C/m ²)
Forest land			
Productive	521.0	260.5	223.7
Impediment (< 1 m ³ /ha)	5.2	2.6	
Agricultural land			
Field*	204.8	102.4	40.3
Hay meadow#	73.7	37.0	
Semi- natural grassland#	29.2	15.0	
Lake and low-productive wetland (GPP)	1.1	0.2	0.1
Shore meadow	5.1	2.5	No data
Total primary production	839.0 ^α	419.5	317.20

* Based on the following annual yields for crops in the Forsmark area (tonnes dw per average km² in the study area: oats 43.5, barley 144.3, winter wheat 5.5, unspecified (mixed crops) 11.5.

Hay meadows and semi-natural grassland are assumed to contribute equally (50%) to the cultivated pasture/meadow land.

α No data on the production in high productive wetland could be located. Since this land class is very small in the SFR area the lack of data will have very little importance for the total production in the model area.

10.2 Future development

/Jerling et al., 2001/ studied the past development of the vegetation in a coastal area, the Södertörn peninsula, in the southern part of the Stockholm archipelago, which is analogous to the Forsmark area in many ways. Predictions of the future development of the vegetation have been based on knowledge concerning the past vegetation.

The history of vegetation is a combination of long-term and short-term changes. Differences in plant community structure can be related, to a large extent, to climatic change and human activities. Three factors mainly drive the shorter-term changes in vegetation development; human management, colonisation of species on islands from the main land and succession in relation to shore displacement. In the predictions of future development of vegetation, changes in climate and most human activities are omitted.

10.2.1 Succession

Regional succession

Figure 10-2 shows the number of species of vascular plants in an east west gradient from the mainland to the outermost islands in the southern part of the Stockholm archipelago. The number of species on islands decreases as one moves from the main land outwards through the archipelago. There are several reasons for this. The number of species in a particular area is a function of dispersal ability and the potential to establish and persist.

Some species possess efficient dispersal characteristics. Others are poor dispersers. The latter will be out-distanced in the colonisation race but may slowly catch up. Even though a species may reach an island it may not be able to establish, e.g. the abiotic environment prevents establishment, competition from other species, lack of a suitable biotic environment. Several plant species are thought to be absent from the outer archipelago because there are no forests there, i.e. the forests have to be there first.

The flora of the archipelago of today is somewhat special depending on the relatively high proportion of deciduous trees, of which alder is a key species producing litter rich in nitrogen. The flora of the organic soils formed may include more demanding plant species such as Ramsons (*Allium ursinum*), Wood barley (*Hordelymus europaeus*) and others. Bushes or small trees are frequently mixed in e.g. Guelder rose (*Viburnum opulus*), Mountain currant (*Ribes alpinum*) and Yew (*Taxus baccata*).

In small populations, as on small islands, the risk for extinction is increased. Thus, there is a faster turnover of the populations of many species in the outer archipelago. This rapid turnover may reduce the diversity. Small islands, dominant in the outer archipelago, are more difficult targets for seeds to hit. Furthermore they carry smaller populations inferring increased risks of extinction, and are thus expected to contain fewer species. This is obvious from the graph in Figure 10-2. As the area of islands increase they will approach the same level of species number as that of the mainland.

N.O. SPECIES FROM MAINLAND TO OUTER SKERRIES

Correlation: $r = -,7027$

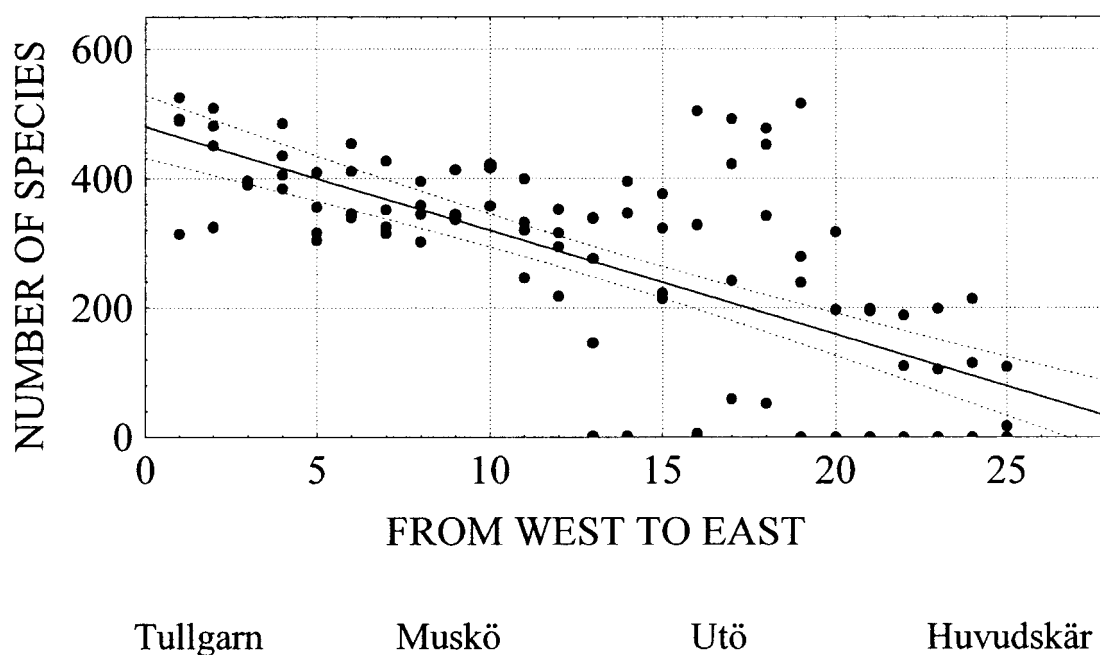

Figure 10-2. The number of species of vascular plants in an east west gradient from the mainland to the outermost islands in the southern part of the Stockholm archipelago. A significant reduction in the species pool from mainland to outer skerries can be seen /Jerling et al., 2001/.

Local succession

Post-glacial isostatic land uplift affects the entire coastline of the northern Baltic Sea. The most important abiotic conditions, affecting the vegetation community on the sea-shore, are due to the soil type, the degree of exposure and the salinity. The soil type is strongly connected to the degree of exposure, where high wave exposed areas contain larger stone fractions than areas with low exposure. Studies of the vegetation on the Baltic Sea shores show that emerging areas are rapidly colonised by vegetation. Because of the flooding frequency and salt spray intensity, the vegetation composition does not change independently from the land uplift rate until many years after emergence of sites from the sea.

A long time after the emergence of an island the colonising plants risk being submerged, as the variation in sea level is more than a meter annually. Thus, the first colonisers must be tolerant to inundation. In crevices and depressions debris may accumulate together with litter from established organisms. This material facilitates colonisation by new species. As the risk for inundation decreases lichens and mosses establish and build up organic soils. These new soils are mixed with bird faeces, forming soils that are favourable for a number of colonising plants.

Litter from the new species adds to the loose material. Some species like alder and hawthorn have litter that is rich in nitrogen, facilitating the establishment of many other species. Bushes and trees create a varied light environment and thus, new habitats. In this way, the flora and vegetation steadily changes, but with a relatively high degree of determinism. This results in patterns related to the age, size and physical properties of islands.

The vegetation zonation of the primary succession of the Baltic Sea shore is not only a response to changes in environment due to land uplift, but also a successional trend reflecting micro climate, edaphic and topographic heterogeneity, or salt spray gradients. The degree of wave exposure at the site may also influence plant establishment. Human activities may also disturb the sequence. After primary succession, the internal dynamic of the communities is the main structural process in the sea shore system.

In an undisturbed coastline the winter ice often leaves traces of ice erosion. Alder is a species that seldom establishes in closed vegetation and relies on gap in the terrain. Along the coastline a fringe of alder is common as a result of establishment in the ice-eroded scars.

Succession in the SFR area

The Baltic Sea shore can be divided into four different types: rocky shores, shores with fractions of pebbles/moraine, sandy shores and shores with fine sediments. In the SFR area, shores with various fractions of pebbles together with moraine are the most common; rocky shores and shores with fine sediments do occur.

The moraine shores with various fractions of pebbles have a sparse vegetation, even though the amount of nutrition may be high, favouring species like Lyme grass (*Elymus arenarius*), Marram (*Ammophila arenaria*), Scentless mayweed (*Matricaria perforata*), Oraches (*Atriplex spp.*), Silverweed (*Potentilla anserina*) and Woad (*Isatis tinctoria*). On the rocky shores the lichen vegetation and the tree border grows close to the water line. Further up on the rocks, where there is available soil, the lichen zone changes to a community dominated by vascular plants. All species on the rocky shore are salt- and drought resistant, e.g. Stonecrops, Plantains, Mayweed.

A general pattern for vegetation zonation in a sea shore site on the Baltic Sea coast is hard to predict, because of local factors such as soil type (rock, boulder, pebbles, sand and fine sediment), the surrounding plant communities systems and the type of land use. When the fissure valley landscape occurs in the coastal area, pine (*Pinus sylvestris*) forest and exposed bedrock is found all the way down to the water level. In areas with pebbles or fine sediment the sea-shore often is used for grazing, i.e. sea shore meadow, and the succession zonation is more fine scaled.

It is possible to make a generalised zonation for moraine shores in the SFR-area, with a time scale according to the land uplift rate. An example of one type of moraine/pebble shore in the SFR area is presented in Figure 10-3, showing the occurrence of the different plant communities.

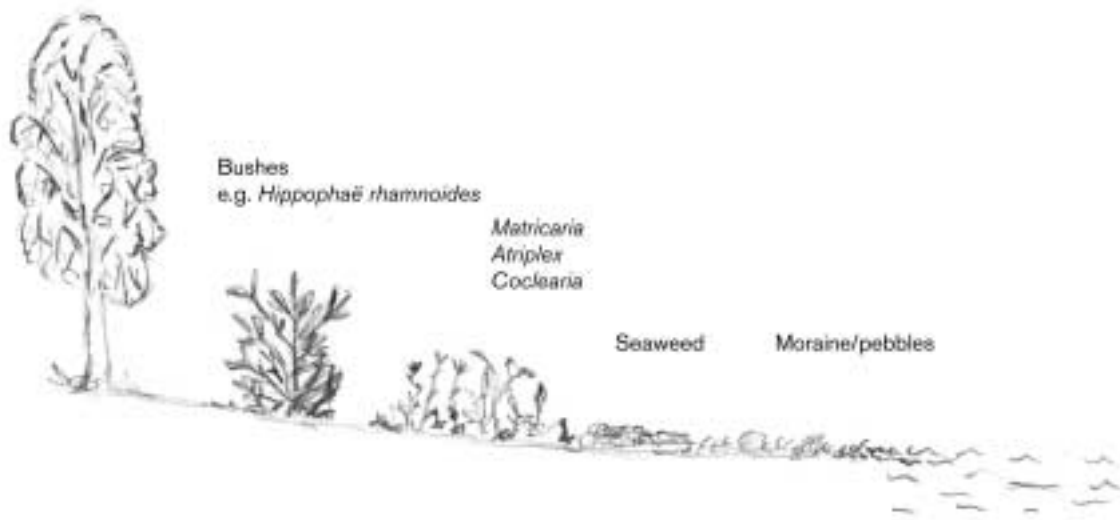

Figure 10-3. A generalised figure of an exposed moraine/pebble shore in the SFR region. The lower part of the sea-shore often has poor vegetation. Above the seaweed zone, salt and water tolerant species can establish. Further up, shore bushes like hawthorn (*Hippophaë rhamnoides*) are common in front of a border of trees. Time scale according to land uplift rate /Jerling et al., 2001/.

Below, a general description of the zonation of the plant community on fine sediment in the Swedish archipelago is given together with a presentation of the most common species. The size of the zones is not estimated since they are depending on how steep the slope is on the sea shore.

Zone 1 Because of the frequent inundations close to the shore line, species with high water tolerance inhabit this zone. Many species in this zone have the ability to store air bubbles for CO₂ supply. If the sea-meadow is grazed the zones are more defined close to the reed-zone.

Species: reed (*Phragmites australis*), rush (*Schoenoplectus lacustris*), Horned pondweed (*Zannichella palustris*), Beaked tasselweed (*Ruppia maritima*).

Zone 2 Since the water level in the archipelago may have an amplitude of 1.5 metre, the species existing further up, in zone 2, must be able to tolerate flooding during some time during the year. Increased sedimentation makes it possible for species depending on deeper soil cover to establish.

Species: Tufted hairgrass (*Deschampsia cespitosa*), Slender spike-rush (*Elocharis uniglumis*), Sedges (*Carex spp*).

Zone 3 Further inland the ground is swampy, favouring several species. The species in this zone must also be able to tolerate frequent salt sprays.

Species: Saltmarsh rush (*Juncus gerardi*), Sea plantain (*Plantago maritima*), Sea milkwort (*Glaux maritima*).

Zone 4 The ground in the fourth zone is drier. Because of evapotranspiration the ground dries up but the salt remains and creates a hard salt crust on the ground surface, which is very difficult to penetrate for some species. Therefore this zone has sparse vegetation.

Species: Lesser Sea-spurrey (*Spergula salina*), Saltmarsh grass (*Puccinellia distans*), One-flowered glasswort (*Salicornia europea*).

Zone 5 In this zone the plant community is similar to a sea-shore meadow.

10.2.2 Future vegetation of the model area

Geologically the model area consists mainly of outwash till rich in calcareous deposits with big boulders (a diameter between 1 and 2 m is common). Sedimentation in the future terrestrial areas will generally be small with the exception of a few persistent lakes. Thus, the sediment will be thick enough to cover the boulders in only a few places. /Jerling et al., 2001/ concluded that it was reasonable to assume that only insignificant areas have the potential to be used for agricultural purposes at least with the techniques of today. However, we cannot foresee how techniques to exploit nature will be developed in the future. Based on the landuse until today it seems reasonable to assume that forestry will dominate the future exploitation of the area. Open land in general is confined to shores, mires and rocky outcrops of bedrock and will therefore be of little spatial significance. Open grassland (dry, moist and wet grasslands) are excluded since the significance of these categories becomes unimportant when management is excluded. The only type of open grasslands that will occur is shore meadows, which in absence of management, only will consist of a narrow fringe close to shores.

/Jerling et al., 2001/ predict that almost all terrestrial areas with a groundwater level below the soil surface eventually will end up in different types of forest, as occurs today. The forest types will vary depending on the substrate and on the water content of the soil and soil mobility. In areas with ground water level above the soil surface, lakes and mires will develop, though most of these will, sooner or later, become forests.

Based on the vegetation map of the present situation as well as on the dominating soil types of the area, the topography and closeness to the sea, transitions from aquatic to terrestrial vegetation were predicted. In addition the altitude above sea level was used to predict the dominating types of vegetation. The classes of vegetation predicted are kept on a generalised level, partly to emphasise the subjectiveness of the prediction, partly to make it clear that the material is not to be regarded as a scientific prediction but rather as a good guess based on science.

Basic assumptions underlying the predictions are:

- that the climate is not changing; change is driven mainly by the shore displacement
- shore displacement continues at the same speed for the whole future period as described in Chapter 5.
- the species pool remains relatively constant i.e. the species which are the dominating elements in the vegetation remain the same
- species do not change their ecological habits and the niches remain constant
- agriculture is absent in the area and the vegetation is left for free development or managed for forestry i.e. the cultural landscape is not taken into account.

All these assumptions are simplistic and to some extent determine the direction of the predictions of future vegetation.

10.2.3 The vegetation year 3,000 AD

Figure 10-4 is a generalised map of the predicted vegetation of the Forsmark area at the year 3,000 AD.

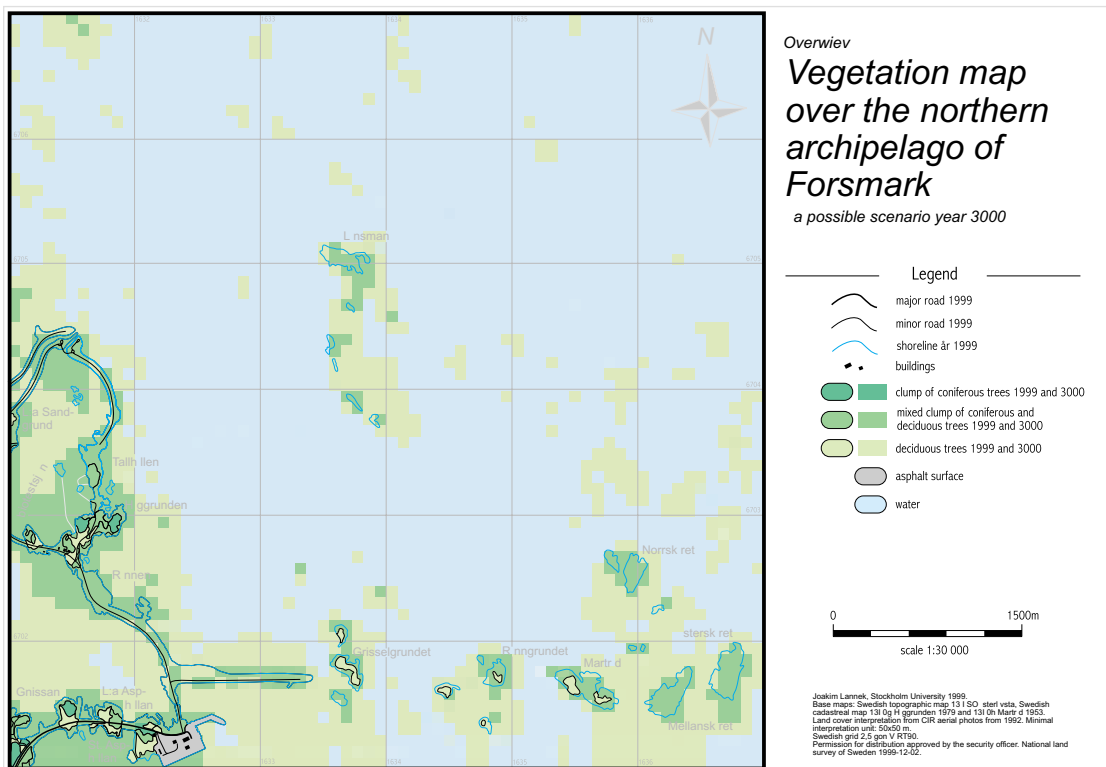

Figure 10-4. *Vegetation map of year 3,000 AD /Jerling et al., 2001/.*

The flora will presumably be very close to the one seen in corresponding areas of today. Almost all of the Biotest lake and the bay just south of it have become terrestrial and are covered with about equal parts of deciduous forests and mixed forests (compare with figure 10-1 (present day vegetation). Reeds and alder woods fringe the remaining lakes. The coast-line is pushed outwards outside Grisselgrundet where about equal parts of deciduous and mixed forests will develop. The areas of highest elevation are covered with coniferous forest, while the lower, wetter areas carry deciduous forests, mainly alder. The skerries Länsmän and the islands just south, as well as Norrskäret, Österskäret, Mellanskäret and Marträäd, have grown into one island where deciduous forests dominate. Rönnggrundet has grown considerably into terrestrial areas dominated by deciduous forests although mixed forests occur. New islands have emerged further out in Öregrundsgrepen. They contain either open land on rocky outcrops of bedrock and close to the shore line, or deciduous forests where either the sediment or the organic material is thick enough. Many of the coves and flades will be colonised by reeds.

10.2.4 The vegetation, year 4,000 AD

Figure 10-5 is a generalised map of the predicted vegetation of the Forsmark area at the year 4,000 AD.

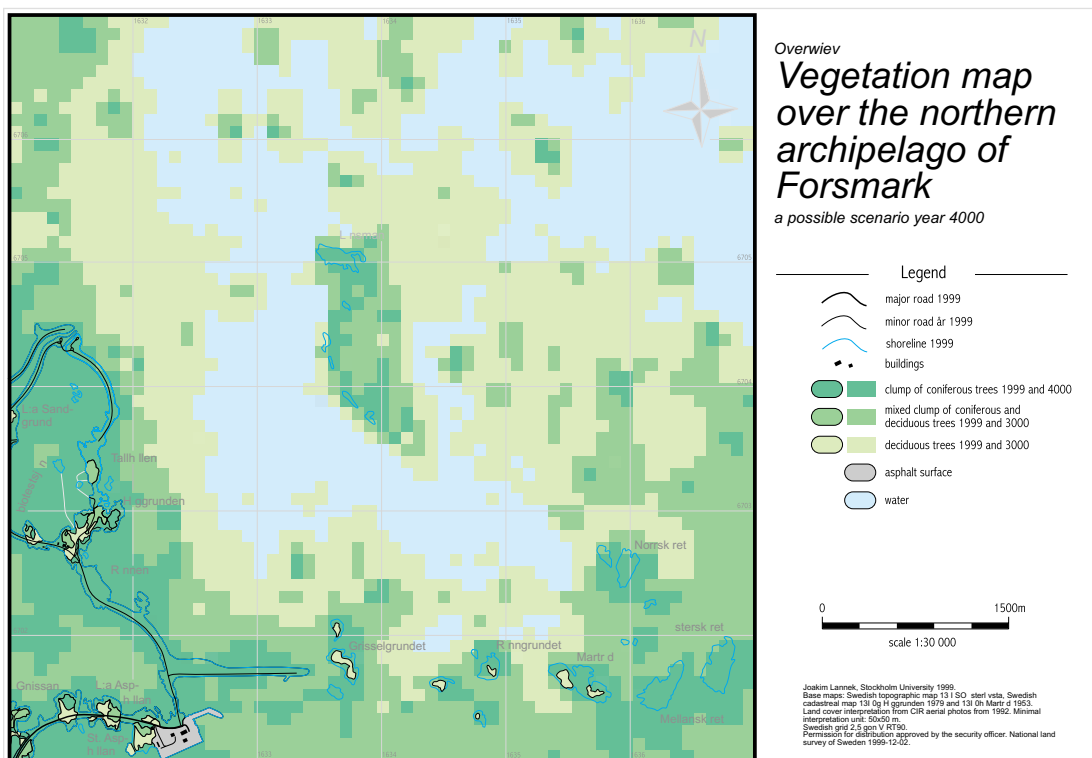

Figure 10-5. Generalised map of the predicted vegetation year 4,000 AD /Jerling et al., 2001/.

A major part of the SFR area is at this time terrestrial. There remains a bay with only a narrow mouth to the sea (which is not seen in the map). This bay will presumably be encroached by reeds and rushes (not indicated) which makes the area appear as open wet grassland. The lower parts of the coastal area will be covered by deciduous forest. The forests now consist mainly of alder in wet areas, whereas ash will dominate in slightly drier sites. In moist ground, aspen is expected to colonise. In areas of higher altitude mixed forests will be replaced by coniferous forests with pine dominating in dry areas, and spruce in moist areas.

10.2.5 The vegetation year 5,000 AD

Figure 10-6 is a generalised map of the predicted vegetation of the Forsmark area at the year 5,000 /Jerling et al., 2001/.

Only a small lake is now left in the SFR area. The coniferous forests dominate although in lower areas such as the former bay the mixed forest element is significant. The pure deciduous forest type is reduced to moister areas in depressions, where the terrestrial habitat is of more recent date. The composition of species and their habitat requirements will follow the patterns already described in former sections.

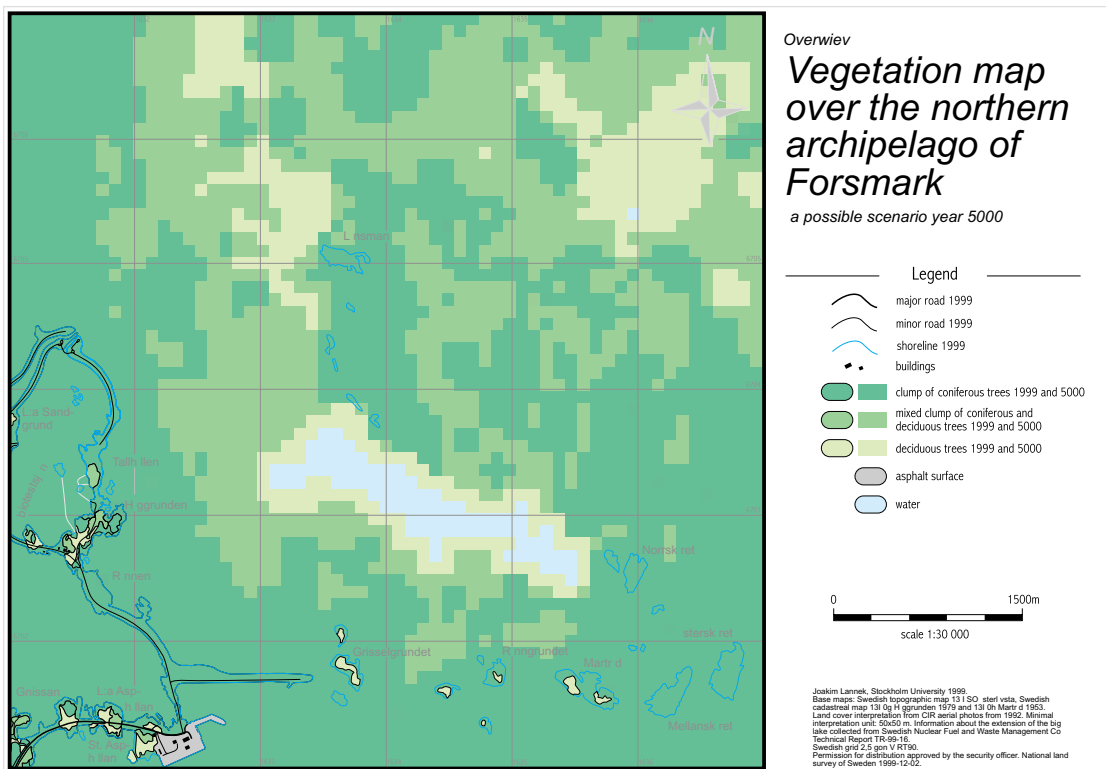

Figure 10-6. Generalised map of the predicted vegetation year 5,000 /Jerling et al., 2001/.

10.2.6 General conclusions

On a general level, coniferous forests, mixed forests and deciduous forests will dominate the emerging island and land (assuming limited human impact in the area). In the local model area, wetlands will generally be replaced by drier areas. The type of vegetation developing is of great importance to the transport of the components of organic material, e.g. carbon. The relative abundance of wet and dry areas is important for the carbon release-accumulation balance. In wet areas, mires and lake-sediments, decomposition is slow due to oxygen deficiency, and organic production exceeds decomposition, i.e. carbon accumulates. In drier areas, decomposition of organic material is fast, increasing the release of carbon to the atmosphere as carbon dioxide, increasing the release of carbon. The net effect of these two opposing processes depends upon the relative area of different ecosystems together with data concerning carbon fixation and decomposition for each type of ecosystem.

10.3 References

Jerling L, Schüldt R, Isaeus M, Lanneck J, 2001. The terrestrial biosphere in the SFR region.
SKB R-01-09, Svensk Kärnbränslehantering AB

Spangenberg J, Eriksson S, 2000. Naturvärden i Forsmarksområdet. Sammanställning av befintliga inventeringar, planer och program samt en fältstudie.
SKB R-00-20, Svensk Kärnbränslehantering AB

11 Surrounding lakes

The characteristics of lakes in the SFR and Forsmark area and their development over time has been analysed in two reports /Brunberg and Blomqvist, 1999, 2000/, which are summarised below.

11.1 Introduction

Along the coastal areas of Sweden new lakes are continuously being formed as the land rises. New surface water catchments will develop, and within these catchments both rivers and lakes will be formed.

An ontogenic process starts immediately after the formation of the lakes, whereby the basins are filled with sediments and eventually the lakes become extinct. Depending on the environmental conditions the lakes may become either bog or forest.

/Brunberg and Blomqvist, 2000/ have carried out a study of the lakes within the Forsmark area with the aim of characterising the different main types of lakes and their development from the time they are cut off from the waters of the Baltic due to land rise. The study provides a basis for prediction of lake ontogeny, which can be used for the new lakes by shoreline displacement during the next 10,000 years.

11.2 Present day

The present lakes in the Forsmark area are shown in Figure 11-1 below.



Figure 11-1. The lakes in the “Forsmark area” within the SMHI catchments no 54/55 and 55. Lakes indicated by number refer to the oligotrophic hardwater lakes (54/55) and the brownwater lakes (55) respectively, which are discussed in the text (sections 11.3.1 and 11.3.2) /Brunberg and Blomqvist, 2000/.

The lakes, which are situated in the Forsmark area (as delimited above), have several characteristics which separate them from the lakes of Uppsala County in general:

- Because of their location close to the Baltic coast in a lowland area the lakes in the Forsmark area are generally younger than the inland, i.e. more elevated, lakes.

- Lakes in the Forsmark area are situated in an area where the soil is mainly till, which means that the land use in the catchments is not so intense as in the catchments which have been formed on the post-glacial clay. This is reflected in the percentage of wetland and farmland, where the Forsmark lake catchments have a higher percentage of wetland but lower percentage of farmland.
- The lakes in the Forsmark area have not been subject to drainage and lowering of the water level to the same extent as the average (or median) lake of the county. The average lowering of the lake water levels caused by land drainage is 0.75 m for the whole county, while the corresponding value for the lakes of the Forsmark area is 0.28 m.
- The Forsmark lakes are smaller, shallower and have smaller volume of water than the lakes of Uppsala County in general, and the renewal time of their water is shorter.
- The water chemistry does not differ much between the two groups of lakes. Slightly less nutrient-rich conditions are shown for the Forsmark lakes if compared to average values. The lakes of the Forsmark area clearly have a much better buffering capacity than the other lakes of the county, indicated by the higher concentrations of bicarbonate (HCO_3^-) ions, and are slightly less nutrient-rich.

11.2.1 Identification of characteristic lake-types within the Forsmark area

The environmental conditions within the drainage area, and thereby the quality of the inflowing water, is one of the most important factors determining the character of the lake ecosystem. Therefore, the composition of the soils, in particular the calcium content, within the drainage area has been used as a basis for distinguishing between different lake types in the Forsmark area, as this affects the inflow of different substances to the lakes. Using data on the soils of northern Uppland, the lakes within the selected area could be divided into two different categories:

1. Brownwater lakes: Lakes whose draining areas have less than 6% calcareous matter in the fine grain fraction of the till. These lakes are found within the drainage area of River Forsmarksån, situated mostly within the main river of this water system. These lakes are characterised by high water flow and thus very large influence from the upstream water system.
2. Oligotrophic hardwater lakes (more usually known as Chara lakes): Lakes draining areas with more than 20% calcareous matter in the fine grain fraction of the till. This type of lakes is described in detail in section 11.3.1

Although oligotrophic hardwater lakes and brownwater lakes dominate the coastal region of the Forsmark area, the formation large, comparatively deep, and naturally highly eutrophic lakes must be considered. This type of lake therefore forms the third type of lake studied.

11.3 Lake characteristics

11.3.1 Oligotrophic hardwater lakes

A summary of the data collected for the oligotrophic hardwater lakes in the Forsmark area (average, maximum and minimum values) is given in Table 11-1. Additional data from other oligotrophic hardwater lakes in the area, complemented with data from studies of *Chara* lakes from different areas of Sweden and Europe, have been used where data from the Forsmark area were lacking.

Table 11-1. Characteristics of oligotrophic hardwater lakes in the Forsmark area /Brunberg and Blomqvist, 2000/.

Parameter	Average	Median	Max	Min	N obs
Catchment characteristics					
Catchment area (km ²)	6.57	1.85	54.80	0.22	11
Forest (%)	70.8	71.5	83	57	10
Wetland (%)	16.2	15.5	28	6	10
Farmland (%)	3.9	2.5	20	0	10
Lakes (%)	9.1	10.5	17	0	10
Other land use (%)	0	0	0	0	10
Lake morphometry					
Lake area (km ²)	0.14	0.07	0.61	0.03	11
Average depth (m)	1.0	0.9	1.9	0.5	9
Maximum depth (m)	1.8	1.7	3.2	0.9	9
Volume (Mm ³)	0.155	0.066	0.427	0.022	9
Elevation m.a.s.l.	4.70	5.50	10	0	10
Water renewal time (days)	194	229	383	1.2	9
Lowering of water level (m)	0.22	0.15	0.75	0	10
Water chemistry classification					
Total P, where	2.1	2.0	3	1	8
1= \leq 12.5 (\square g P/l)					
2=12.5-25 (\square g P/l)					
3=25-50 (\square g P/l)					
4=50-100 (\square g P/l)					
5= $>$ 100 (\square g P/l)					
Alkalinity, where	1.0	1.0	1	1	10
1= $>$ 0.20 (meq/l)					
2=0.10-0.20 (meq/l)					
3=0.05-0.10 (meq/l)					
4=0.02-0.05 (meq/l)					
5= \leq 0.02 (meq/l)					
Water colour, where	3.5	3.5	5	2	10
1= \leq 10 (mg Pt/l)					
2=10-25 (mg Pt/l)					
3=25-60 (mg Pt/l)					
4=60-100 (mg Pt/l)					
5= $>$ 100 (mg Pt/l)					
Oxygen conditions	3.1	4.0	4	1	7
1=small risk for low O ₂ conc during winter					
2=risk for $<$ 5 mg O ₂ /l					
3=risk for $<$ 1 mg O ₂ /l					
4=risk for anoxic conditions					
Data from standardised survey gillnet fishing					
Number of fish species	3.7	4.0	5	1	6
CPUE* no of ind.	36	31	76	14	6
kg	3.6	3.7	7.8	0.32	6

* Catch per unit effort.

Catchment areas

The drainage areas of the oligotrophic hardwater lakes in the Forsmark area are generally very small (Table 11-1). Only one catchment has a large size (54.8 km²); the other lakes have catchments with areas less than 5 km². The geology of the catchment areas consists of a bedrock dominated by granites and gneisses, covered by calcareous glacial till and in minor areas postglacial clay (coinciding with agriculture areas). The high content of lime in the till originates from the kambrosilurian area in the Bothnian Sea.

The vegetation of the catchments is dominated by forest and wetlands which together cover 87% of the area (median value, Table 11-1). The lakes themselves constitute a large proportion (median 10%) of the catchment area. These lakes are always furthest upstream of all lakes in the subcatchment. The differences in elevation within the catchments are often small, especially in the riparian zone. Visible inlets as well as outlets are often more or less lacking, unless the catchments have been subject to drainage projects. Thus, a major part of the water transported through the catchments is more or less filtered through the surrounding wetlands before entering the lakes.

Lake morphometry and water turnover

The oligotrophic hardwater lakes in the Forsmark area are generally very shallow, with an average depth of 0.9 meter (median value, Table 11-1) and have small areas. The small water volumes give a short renewal time of the water. The water renewal time has been estimated to ca. 240 days.

Sediment characteristics and sedimentation rate

Oligotrophic hardwater lakes are often characterised as “bottomless”; i.e. there is no distinct border between the very soft sediment and the lake water. The lake sediments are very unusual and very characteristic. The calcareous and highly organogenic sediment is of autochthonous origin, with minor contribution of mineral particles. It has been characterised as “algal gyttja” or “cyanophycée gyttja”. The microbial activity in these lake ecosystems is concentrated to the soft bottoms.

The sediments of the oligotrophic hardwater lakes in the Forsmark area, are of two types, depending on the amount of mineral particulates transported to the lake. The typical cyanophycée gyttja is reddish-brown, gelatinous and almost free from mineral particles, except for precipitated CaCO₃, which in some cases may add a greyish colour to the sediment (“lime gyttja”). Lakes where mineral particles from the drainage area are mixed into the sediments have a green or bluegreen coloured non-gelatinous surface sediment. This is the case when the inflowing water reaches the lake by visible inlets instead of being filtered through the riparian zone from diffuse sources. Sedimentation rates are approximately 1–1.5 mm of sediment per year during the oligotrophic hardwater stage.

Water chemistry

The *Chara* lakes are chemically characterised as hard-water lakes and have a high conductivity and richness of calcium and magnesium dissolved in the water. However, due to both chemically and biologically induced interactions in the lake water, the amounts of nutrients (e.g. phosphorus) transported to the lakes may be effectively reduced by precipitation of calcium-rich particulate matter. This restricts the production of organisms in the lake that not have access, directly or indirectly, to the sediments as a nutrient source. Nitrogen, on the other hand, tends to be present in relatively high concentrations in the water, due to the combination of high input but low biotic utilisation.

The oligotrophic hardwater lakes of the Forsmark region all show the typical hard-water lake chemistry, although the principal source of the hardness is not the bedrock but the glacial till and postglacial deposits constituting the soils in the area. Most of the lakes have low or moderately high phosphorus concentrations (<12.5 and 12.5-25 µg P/l, respectively). The alkalinity is very high, varying between 1.35 and 4.21 meq/l and the lakes have a very good buffer capacity.

Table 11-2 below shows the ionic composition of the bicarbonate group of the *Chara* lakes in Uppland.

The oligotrophic hardwater lakes often experience oxygen deficit during the winter period. This is not surprising, considering the shallowness and small water volume of these lakes. The effects of the depletion of dissolved oxygen may be seen on e.g. the structure of the fish community.

The riparian zone

Most of the oligotrophic hardwater lakes in the Forsmark area are, to a large extent surrounded by mires, which in the outermost part form floating mats constituting the littoral zone of the lake. The mires often have a mixed character with components of pine bog, poor fen, rich fen, extremely rich fen and, at the edge of the lake, *Phragmites*-populated floating *Sphagnum*-mats. The dominating constituents of the bottom layer and important constituents of the field layers of these mire components are shown in Table 11-3 below.

Table 11-2. The ionic composition of the bicarbonate group of *Chara* lakes in Uppland from /Forsberg, 1965/.

Ion (equiv. %, average values)						
Ca	Mg	Na	K	HCO ₃	SO ₄	Cl
79.1	10.9	8.3	1.7	71.9	22.7	5.4

Table 11-3. Important constituents of the mire components of the riparian zone, oligotrophic hardwater lakes.

Mire component	Bottom layer,	Field layer
Pine bog	<i>Sphagnum</i>	<i>Ledum palustre</i> , <i>Rubus chamemorus</i> , and <i>Eriophorum vaginatum</i>
Poor fen	<i>Sphagnum</i>	<i>Rhynchospora alba</i> , <i>Scheuchzeria palustris</i> , <i>Carex rostrata</i> , and <i>C. lasiocarpa</i>
Rich fens, interspersed with extremely rich fen	A variety of brown coloured mosses	<i>Parnassia palustris</i> , <i>Primula farinosa</i> , <i>Dactylorhiza incarnata</i> , <i>Epipactis palustris</i> , <i>Liparis loeserii</i> , and <i>Dactylorhiza traunsteineri</i>

From the point of view of the functioning of the combined mire-lake ecosystem, at least four potentially important observations can be made.

1. The strongly variable character of the surrounding mire-littoral system indicates interesting differences in hydrology and water chemistry between its components.
2. The horizontal growth of the surrounding mire is an important part of the ontogeny of the entire lake ecosystem towards a mire.
3. A characteristic of this kind of lake, is the compact character of the littoral zone. This almost closed, often floating, three-dimensional littoral system, dominated by *Sphagnum* (which in turn to some extent is colonised by *Phragmites*), most likely minimises the access to the system for larger lake biota (e.g. fish and benthic fauna).
4. For many of the lakes, the drainage of the system is “diffuse” through the mire. It is not until the edge of the mire is reached that the outlet becomes visible. This filtration of the outflowing water must have considerable impact on the water quality as biologically active compounds probably are efficiently retained in the mire.

11.3.2 Brownwater lakes

Brownwater lakes are characteristic compartments of the boreal forest zone. The colour of the water originates from large amounts of dissolved organic material in the form of humus which are transported from the soils of the drainage area to lakes and streams, and these compounds have a substantial influence on the ecosystem functioning.

In the following description, data for all lakes of the River Forsmarksån larger than 3 hectares are included together with data from three additional brownwater lakes in the Forsmark area. The data collected is summarised (mean, median, maximum and minimum values) in Table 11-4.

Table 11-4. Characteristics of brownwater flow-through lakes in the Forsmark area /Brunberg and Blomqvist, 2000/.

Parameter	Average	Median	Max	Min	N obs
Catchment characteristics					
Catchment area (km ²)	111.7	105.5	285	4.8	14
Forest (%)	64.1	64.5	78	50	14
Wetland (%)	25.7	25.5	46	5	14
Farmland (%)	4.5	2.0	20	0	14
Lakes (%)	5.6	6.0	10	0	14
Other land use (%)	0	0	0	0	14
Lake morphometry					
Lake area (km ²)	1.30	1.14	4.09	0.09	14
Average depth (m)	1.5	1.5	2.8	0.5	11
Maximum depth (m)	2.6	2.7	4.0	1.2	12
Volume (Mm ³)	2.142	0.999	7.771	0.170	11
Elevation m.a.s.l.	22.4	28.0	32	4	14
Water renewal time (days)	69	31	249	2	11
Lowering of water level (m)	0.39	0.30	1.0	0	11
Water chemistry classification					
Total P, where	2.2	2.0	3	2	12
1= \leq 12.5 (\square g P/l)					
2=12.5-25 (\square g P/l)					
3=25-50 (\square g P/l)					
4=50-100(\square g P/l)					
5= $>$ 100 (\square g P/l)					
Alkalinity	1.0	1.0	1	1	13
1= $>$ 0.20 (meq/l)					
2=0.10-0.20 (meq/l)					
3=0.05-0.10 (meq/l)					
4=0.02-0.05 (meq/l)					
5= \leq 0.02 (meq/l)					
Water colour	4.3	4.0	5	4	14
1= \leq 10 (mg Pt/l)					
2=10-25 (mg Pt/l)					
3=25-60 (mg Pt/l)					
4=60-100 (mg Pt/l)					
5= $>$ 100 (mg Pt/l)					
Oxygen conditions, where	1.9	2.0	4	11	13
1=small risk for low O ₂ conc during winter					
2=risk for $<$ 5 mg O ₂ /l					
3=risk for $<$ 1 mg O ₂ /l					
4=risk for anoxic conditions					
Data from standardised survey gillnet fishing					
Number of fish species	7.1	7	9	5	12
CPUE no of ind.	45	43	88	18	12
kg	1.92	1.75	4.1	0.42	12

Catchment areas

There is a considerable variation in the size of the lake sub-catchments of the brown-water lakes in the area. This is due to the fact that most of the lakes are part of a chain within the main river, thus successively adding the lakes together in an increasing catchment.

The geology of the catchment areas consists of a bedrock dominated by granites and gneisses, covered by glacial till and in some lower parts also by postglacial clay. The vegetation is dominated by forest, which covers 64% (median value) of the area (Table 11-4). Wetland is also an important component of the catchment areas (median 26%), partly due to the presence of a very large mire complex in the upper parts of the River Forsmarksån catchment. The proportion of farmland is generally low.

The difference in elevation of land naturally divides the River Forsmarksån into two parts; one above and one below the 13 meter high waterfalls at Lövestabruk, respectively (Table 11-4).

Lake morphometry and water turnover

The median surface area of the brownwater lakes of the River Forsmarksån (Table 11-4) (1.3 km²) is much larger than that of the oligotrophic hardwater lakes in the adjacent area (0.07 km²). The average depth (1.5 m) is also larger than that of the oligotrophic hardwater lakes (0.9 m). Hence, the brownwater lakes also hold a larger volume of water than the adjacent oligotrophic hardwater lakes. The brownwater lakes of River Forsmarksån have a shorter median water renewal time (31 days) than the oligotrophic hardwater lakes (240 days) due to that the main river passes through most of the lakes.

Sediment characteristics and sedimentation rate

The lake sediments are brown in colour and organogenic. This indicates a characteristic “dy” sediment with large contribution of allochthonous material (i.e. material that has not been produced within the lake). The lakes are situated in an area with strong influence from wetlands producing organic compounds (humus) that are transported to the lakes. Some of the lakes have substantial autochthonous production of higher vegetation (e.g. *Phragmites*), which also contributes organic matter to the sediments.

Paleoecological studies of the sediments of Lake Vikasjön show that this lake initially passed through an oligotrophic hardwater stage after the isolation from the Baltic Sea, during which “cyanophycée-gyttja” was settled. After about 1,000 years, the sediment switched to dy character, due to the influence of humic compounds from the surrounding mires which were developed in the drainage area. Most of the lakes in the upper parts of River Forsmarksån have the same or at least a similar historical record in the sediments. In contrast, the lakes which are situated below the 13 m falls at Lövestabruk have not passed any oligotrophic hardwater stage. Instead they developed to brownwater lakes more or less directly after the isolation, depositing dy sediments at the lake bottoms. Sedimentation rates roughly correspond to 1 mm per year during the brownwater stage.

Water chemistry

The water chemistry along the length of River Forsmarksån varies very little. The ionic composition of the water in the River Forsmarksån (Table 11-5) indicates, despite the relatively strong water colour, a hardwater system with dominance of Ca²⁺ and HCO₃⁻ ions. This is due to the odd combination in the drainage area of calcareous soils covered by peatlands.

Table 11-5. Water chemistry at two stations in the River Forsmarksån; Lake Vikasjön, in the upper part of the river system, and Johannisfors, 1.5 km from the outlet to the Baltic Sea.

	Ionic composition (equiv. %)							Water colour (mg Pt/l)
	Ca	Mg	Na	K	HCO ₃	SO ₄	Cl	
L. Vikasjön, 28 m a.s.l.	73	10	14	2	76	8	15	180
Johannisfors, 3 m a.s.l.	79	8	11	2	74	15	11	75

The brownwater lakes in the Forsmark area show very high concentrations of total organic carbon (TOC), with a long-term average of 25 mg C/l in Lake Vikasjön and 20 mg C/l in the river at Johannisfors. Most of the humic substances entering the lakes are in the form of dissolved organic compounds (DOC) and the sedimentation of these substances is very low, less than 5%. Elements associated with the DOC also show low retention in the lakes basins, e.g. ¹³⁷Cs. The phosphorus concentrations of the lakes in River Forsmarksån are usually moderately high (12.5–25 µg P/l). The alkalinity is high for brownwater lakes in general and varies between about 0.5 meq/l in the upstream lakes and 1.5 meq/l in the lowland lakes closer to the coast. The oxygen situation during winter is normally good in the lakes, due to the fast flow of water through the system.

The riparian zone

The upper parts of River Forsmarksån, situated upstream of Lövstabruk, drain a wetland area of unusual size in this region. Within the area different forms of peatland form a mosaic pattern of e.g. swamp forest, bogs and rich or moderately rich fens. Thus, the riparian zones of the lakes in this area are to a large extent peatland, often in the form of mires, which are frequently flooded at high water flows. *Phragmites australis* (common reed) is often a dominating compartment of the flora along the lake shores, especially around the in- and outlet streams, sometimes with a transition within the riparian zone to a fen with *Equisetum* (horsetail) and various *Carex* (sedge) species.

The surrounding mire is therefore important in the development of brownwater lakes. Unlike the smaller oligotrophic hardwater lakes, the outer edge of the mire surrounding the brownwater lakes seldom forms a floating mat. Instead, emergent aquatic plants, mostly *Phragmites*, grow in the sediments and form a border between the mire and the open water.

11.3.3 Deep eutrophic lakes

A summary of the data collected for the two deep eutrophic lakes Erken and Limmaren is given in Table 11-6.

Table 11-6. Characteristics of two deep eutrophic lakes, Lake Erken and Lake Limmaren /Brunberg and Blomqvist, 2000/.

Parameter	Lake Erken	Lake Limmaren
Catchment characteristics		
Catchment area (km ²)	141	21.1
Forest (%)	70	68
Wetland (%)	0	0
Farmland (%)	10	6
Lakes (%)	20	26
Other land use (%)	0	0
Sediment data (compiled from Pettersson (1986) and Pettersson and Lindqvist (1993))		
C/N	7.5	7.0
Ca (mg/g dw)	8	5
Fe (mg/g dw)	32	33
Total-P (mg/g dw)	1.2	1.5
Largest fraction* of sediment P	Residual-P	NaOH-P, residual-P
Lake morphometry		
Lake area (km ²)	24.2	5.9
Average depth (m)	9.0	4.7
Maximum depth (m)	20.7	7.8
Volume (Mm ³)	213.5	27.3
Elevation m.a.s.l.	11.7	3.9
Water renewal time (days)	2,701	2,137
Lowering of water level (m)	1.5	1.1
Typical physical and chemical data		
Mixing regime	Dimictic	Monomictic
Duration of ice cover (days)	100–140	100–140
Duration of summer stratification (days)	100	–
Conductivity (mS/m)	25.4	24.7
pH value	8.0	8.0
Alkalinity (meq/l)	1.8	1.4
Calcium, Ca ²⁺ (meq/l)	2.00 (64%)	1.53 (64%)
Magnesium, Mg ²⁺ (meq/l)	0.70 (23%)	0.31 (13%)
Sodium, Na ⁺ (meq/l)	0.35 (11%)	0.51 (21%)
Potassium, K ⁺ (meq/l)	0.06 (2%)	0.06 (2%)
Bicarbonate, HCO ₃ ⁻ (meq/l)	1.80 (60%)	1.40 (65%)
Sulphate, SO ₄ ²⁻ (meq/l)	1.00 (33%)	0.30 (14%)
Chloride, Cl ⁻ (meq/l)	0.21 (7%)	0.45 (21%)
Total N (□g/l)	660	985
Total P (□g/l)	27	54
Silica (□g Si/l)	1.10	1.76
TOC (mg/l)	8.5	9.2
Water colour (mg Pt/l)	20	20
Data from standardised survey gillnet fishing		
Number of fish species	9	7
CPUE no of ind.	66	165
Kg	2.0	4.6

The drainage area

The catchments of Lakes Erken and Limmaren, (Table 11-6), differ substantially in size, but so does also the size of the lakes. Hence, the relative composition of the catchment is very similar between the two lakes. Characteristic for both catchments is the large percentage of the total area; 20 and 26% made up of the lakes themselves. Forest dominates the catchments, while farmland has a minor contribution. Wetland is almost totally lacking, which is a striking difference from the two other lake types described in this report.

The geology is similar in both drainage areas and also similar to that of the Forsmark area. Thus, the bedrock is dominated by granites and gneisses and is covered by lime-rich till of glacial origin. Minor areas, both in the lake basins and on land (coinciding with agricultural areas), have glacial and post-glacial clay deposits.

Lake morphometry and water turnover

Both lakes can be classified as large, i.e. belonging to the largest 10% of the more than 50,000 lakes in the country. The lakes have a relatively modest maximum depth for Swedish lakes in general, though they belong to the deepest lakes in the province of Uppland with average depths of 9 and 4.7 m, respectively. Because of their large volumes and limited drainage areas, the renewal time of the water in the lake basins, 7.4 years for Lake Erken and 5.8 years for Lake Limmaren, is long, especially compared to that of the lakes in the Forsmark area. Both lakes have been lowered more than one meter by drainage projects. With a shoreline displacement of ca. 0.5 m per century, the isolation of Lake Erken can be calculated to year 2,500 BP and that of Lake Limmaren to year 1,000 BP.

Sediment characteristics and sedimentation rates

Lakes Erken and Limmaren have characteristic “gyttja” sediments, with a dark greenish-grey colour. The organic material within the sediments originates mainly from autochthonous production (i.e. material produced within the lake), and the ratios between carbon and nitrogen concentrations are typically low; 7.5 and 7.0, respectively (Table 11-6). The sediment chemistry is generally similar between the two lakes (Table 11-6). In Lake Erken, a major part of the sediment phosphorus is found in the “residual” phosphorus fraction, which is considered to consist mainly of organically bound P. Lake Limmaren has a higher total concentration of phosphorus, most of which is associated to Fe compounds (NaOH-P) and to organic material (residual-P). In both lakes, phosphorus is released from the sediments during some periods of the year.

Due to their large size and wind exposure, the accumulation of sediments at the bottom of the lakes is very heterogeneously distributed. In Lake Erken, the sediments thickness varies between 1.5 and 10 m (including both freshwater and marine sediments). True accumulation bottoms are found only in the deepest parts of the lakes. Other soft-bottoms are subject to substantial resuspension by waves and internal currents, followed by further transport to the deeper areas (“sediment focusing”), making it difficult to assess the sedimentation rate and sediment growth. A yearly sedimentation of ca. 6 mm has been calculated for Lake Erken /Brunberg and Blomqvist, 2000/.

Water chemistry

Lake Erken and Lake Limmaren have similar water chemistries, but different mixing regimes (Table 11-6); Lake Erken is dimictic while Lake Limmaren is unstratified during summer. Both lakes are covered by ice from December to April. Lake Erken normally stratifies in early June and stratification lasts till early September. Both lakes are typical hardwater systems with dominance of Ca^{2+} and HCO_3^- , high pH values and high alkalinity.

Both lakes can be considered as nutrient rich, and Lake Limmaren in particular has very high concentrations of total phosphorus for a lake where influence of human activities is minimal. Concentrations of total nitrogen are moderately high, resulting in very low N/P quotients (24 and 18, respectively) in the lake water. Water colour is very low while concentrations of total organic carbon (TOC) are high, together indicating that most of the organic carbon stems from the high autochthonous production typical of nutrient rich lakes.

The riparian zone

The shores of both Lake Limmaren and Lake Erken are characterised by very narrow riparian zones, consisting of a thin zone of alder trees forming a border between mature coniferous forest and open water or a thin belt of *Phragmites*. Lake Erken has the characteristic vegetation-free wind-exposed littoral zone in large parts of the main basin, and there is a more or less direct transition from forest to open water. In Lake Limmaren, which is smaller and does not have so much of the wind-exposed habitat, there is a sharp transition from mature forest to a *Phragmites*-belt of 10–30 m thickness. Due to the lowering of the water level, particularly in Lake Erken, wetlands in the form of alder forest interspersed with *Phragmites* constitute a major share of the riparian zone in sheltered bays along the Western and Southern shores.

11.4 Water biology

Limnologists traditionally divide the main habitats in lakes into: The open water or pelagial zone, the littoral zone, which is the bottom areas with photosynthesising plants and the profundal zone, which is the deeper parts of the bottom area lacking photosynthesising plants. The littoral zone, is often further divided into the wind sheltered “emergent macrophyte habitat” and “wind-exposed habitat”. In deeper areas of many lakes, a more or less pronounced ecotone between the littoral and profundal zones, “the light-exposed soft-bottom zone” can also be identified. This zone is characterised by the presence of photosynthesising plants in the form of submersed macrophytes and a microflora dominated by cyanobacteria and algae. Thus, five key habitats can be identified in the ecosystem of a lake, all contributing to the total biodiversity of the system. The occurrence of these types of habitat in the three types of lake considered in section 11.2 above is shown in Table 11-7:

Table 11-7. The main habitats in the three types of lakes which may occur in the Forsmark area.

Habitat	Oligotrophic hardwater lake	Brownwater lake	Deep eutrophic lake
Pelagial	Found in all types of lake		
Littoral - Wind exposed	Missing (lakes too small)	Missing (lakes too small)	Yes
Littoral - Wind sheltered, emergent macrophyte zone	Yes	Yes	Yes
Light exposed, soft bottom zone	Yes	Missing due to strong colour of water	Yes
Profundal	Missing (lakes shallow and clear)	Yes	Yes

/Brunberg and Blomqvist, 2000/ have presented a synthesis of the available data concerning the water biology of each of the habitats in the three types of lake, Table 11-7. The information on the biology of the various habitats is synthesised in the next section and in Table 11-9.

11.5 Ecosystem function

The information in the previous sections has been synthesised by /Brunberg and Blomqvist, 2000/ in the form of conceptual models for the three lake types.

11.5.1 Oligotrophic hardwater lakes

The existing hardwater lakes in the Forsmark area can be characterised by the presence of three main key habitats: the sheltered littoral zone, the light-exposed soft-bottom sediments, and the open water. In relatively mature systems, the two former habitats are well developed, and there is reason to believe that both these components may have great influence on the quality of the inflowing water before it reaches the pelagic zone. The open-water habitat, on the other hand, is most likely of little importance to the production and turnover of carbon and nutrients in the system in this as well as in all other stages of succession. The reason for the low importance of the pelagial is that the hardwater lakes typically have very limited drainage areas. As a consequence, most of the inflow is “diffuse”, i.e. in the form of groundwater, and this inflow passes through one or the other of the two bottom habitats. Thus, any water entering the pelagic zone of the lakes has been slowly prefiltered through a biological sieve, and thereby most likely cleared from biologically active substances.

A tentative model for the functioning of the mature hardwater lake based on current knowledge can be formulated as shown in (Figure 11-2):

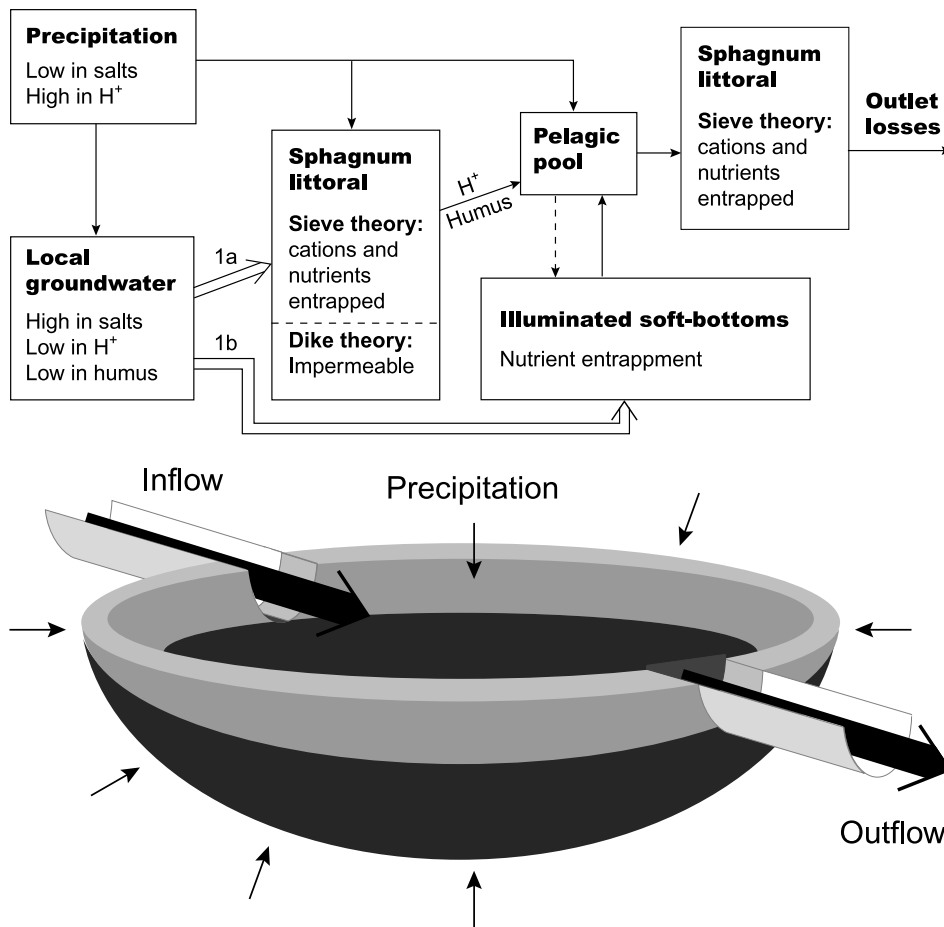

Figure 11-2. A tentative model for the functioning of the mature oligotrophic hardwater lake /Brunberg and Blomqvist, 2000/.

All groundwater entering the mire-lake basin system contains large amounts of carbonates and associated cations. This can be assumed to be the major source of inorganic nutrients for the producers (i.e. heterotrophic bacteria, fungi, cyanobacteria, algae and higher plants) at the basis of the food web in the different key habitats.

Water entering the edge of the mire-sheltered littoral complex may be efficiently filtered by the *Sphagnum* and its necromass, which act as cation exchangers. As the mire-littoral vegetation circumscribes the lake basin, the buffering capacity of the water is successively reduced, as all water entering the system must at least be filtered once (during the passage towards the outlet).

Thus the *Sphagnum* littoral may either be regarded as a separate, slowly growing unit receiving nutrients primarily from rainwater, or as an efficient sieve retaining a major share of the nutrients (“the sieve theory”). An alternative hypothesis, “the dike theory”, is that due to the formation of peat underneath the growing part of the *Sphagnum*-mire, this water is diverged along the outer edge of the mire and does not enter the lake basin, or enters the lake basin after passage under the peat layer. A new hydrological system is created which is fueled by rainwater and which creates a flow of water out of the

system, preventing the calcareous groundwater from entering that habitat (i.e. the raised bog type of hydrological system,). The diverted water is compensated for by more inflow of groundwater in the soft-bottom area, or alternatively the turnover time of the water in the lake basin gets longer. Most likely, both of these processes are important to the metabolism of the system.

The production system inside the *Sphagnum*-littoral seems likely to rely on carbon primarily produced by *Sphagnum* and macrophytes in the field layer above. It is most likely characterised by a very low primary production inside the habitat (e.g. by cyanobacteria and algae) because of the shading from the plants above. The large amounts of organic material produced in the habitat should favour production of bacteria and fungi but, this production is probably restricted because of anoxic conditions, which favours accumulation of peat. It seems also likely that very little basal production is linked further on to higher trophic levels because a) very few, if any, animals are known to feed directly on *Sphagnum* and b) the closed three-dimensional character of the system probably limits the access for aquatic animals such as benthic macrofauna and fish. However, the system will certainly contribute with dissolved allochthonous organic matter to the pelagic zone. By reducing the available light, this organic material will also interfere with the primary production in both the pelagic and soft-bottom habitats.

Water entering the basin through the soft-bottom habitat will pass through an unusually thick microbial mat including autotrophic as well as heterotrophic components. These organisms will sieve off biologically active substances from the water and production will be high in the microbial mat because of the relative fertility of the groundwater which is rich in nutrients from the drainage area. High primary production because of favourable light conditions will lead to elevated pH-values during the growth season and this will result in precipitation of CaCO_3 and co-precipitation of important plant nutrients, especially P but also Fe and Mn, in the surface layer of the sediment. Growth of *Chara*, which deposits CaCO_3 inside the cells, also leads to trapping of nutrients in the system and subsequent deposition in the sediments as the charophytes die. These biologically mediated processes are probably responsible for the oligotrophic hardwater character of the system.

Benthic fauna is known to be rich on submersed macrophytes such as charophytes and the productive microbial mat should favour development of a rich fauna too, but this remains to be proved. It is known that Crucian carp is often dominant in the system and that biomass of fish is high compared to many other parts of Sweden.

The low primary production in the pelagic zone is relatively well documented, and this low production is assumed to be the result of trapping of important nutrients in the other two habitats. An alternative is that bacterioplankton outcompetes phytoplankton for available nutrients. An indication that bacterioplankton production could be substantial is that chrysophytes almost always dominate and these organisms avoid competition with bacterioplankton for inorganic nutrients by ingestion of bacteria.

11.5.2 Brownwater lakes

A tentative model of the ecosystem functioning of the brownwater lakes is shown in (Figure 11-3). The dominating feature of these lakes is the rapid flow of water through the system, which continuously brings allochthonous substances from the upstream wetland and forest areas. They may have a relatively high production at the base of the food web, mainly in the form of pelagic production by heterotrophic bacterioplankton, but a low energy transfer to higher trophic level such as benthic fauna and fish. A major share of the production is exported downstream. Despite the high inflow of water and carbon, the accumulation of organic material in the system is low. This is also true for all the elements entering the lake associated to the humic substances.

The inflowing water is characterised by a strong colour caused by humic substances, mainly in the form of dissolved organic carbon compounds. A large part of the lake water's phosphorus is associated with the dissolved organic compounds, and thereby less available to the primary producers.

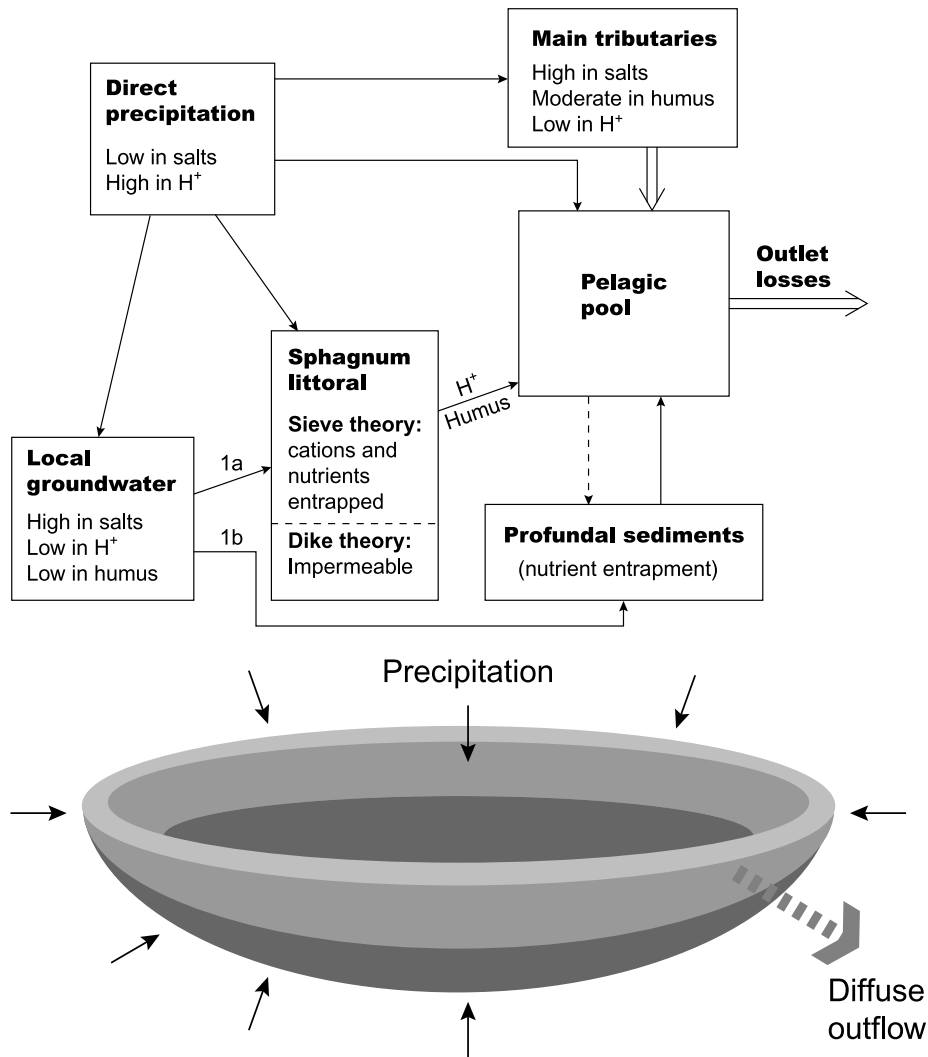

Figure 11-3. A tentative model for the functioning of the brownwater lakes in River Forsmarksån /Brunberg and Blomqvist, 2000/.

The three main habitats of the lakes are the pelagic zone, the emergent macrophyte zone and the profundal zone. Despite both low availability of nutrients and a poor light climate, the pelagic community may be well developed, although of a more heterotrophic character than in less humic lakes. Heterotrophic bacteria, produced within the lake or transported from the upstream areas, mobilise energy to the system at the base of the food web by utilising the organic substances in the lake water. The primary production of the phytoplankton is restricted by the low light conditions as well as of the competition with bacterioplankton regarding nutrients. In addition, the phytoplankton community is usually dominated by mixotrophic flagellates. These organisms are able to ingest bacteria and thereby survive during environmental conditions that restrict purely autotrophic organisms. Both bacterioplankton and phytoplankton are utilised as food for zooplankton, which may have a high production in the brownwater lake ecosystems.

The high flow of water rapidly transports both dissolved and particulate matter through the lakes. As a consequence, the accumulation of material by sedimentation in the lake basins is restricted to a rate of about one millimetre per year. The sediments are of allochthonous character, with low concentrations of nutrients. Thus, the characteristic “dy” sediments of the brownwater lakes are a relatively poor environment, restricting the growth of benthic fauna organisms, the community of which is characterised by low diversity as well as low productivity. The fish community of the lakes in River Forsmarksån have a high diversity, although the production is low.

The emergent macrophyte zone is often well developed along the shores of the lakes. Usually a surrounding mire, dominated by *Sphagnum* mosses, functions as a filter for the water entering the lake, and affects the quality by exchanging cations and nutrients for H⁺ ions and organic acids. The three-dimensional mire littoral is also a more or less closed system for larger organisms, e.g. benthic macrofauna and fish. Rooted emergent macrophytes, typically *Phragmites*, form a border zone between the mire and the open water. Neither this part of the littoral zone to any greater extent seems to provide food items for benthic fauna and fish. The primary production is restricted by low light availability due to shading from the *Phragmites* as well as due to the coloured lake water. However, heterotrophic organisms, e.g. bacteria and fungi, may provide some energy that can be linked to higher trophic levels in the lake ecosystem.

The relative contribution of the littoral zone to total lake turnover of carbon and nutrients is however smaller than in the oligotrophic hardwater lakes, which are completely surrounded by littoral. The relative importance of the littoral zone for the ecosystem functioning is tightly coupled to the hydrology of the system, i.e. how much water is filtered through the littoral zone compared to the inflow from the main river. Nevertheless, the functioning of the littoral zone as a sieve and sink for substances entering from local sources (i.e. via diffuse inflow of water) may be considerable.

11.5.3 Deep eutrophic lakes

A hypothetical model for the ecosystem functioning in this kind of lakes is shown in (Figure 11-4). Due to the large volume of water and the limited drainage area, the water renewal time is low and, as a result internal processes dominate the metabolism of carbon in the systems. Habitat diversity is high and includes all the five key habitats that can be distinguished in lakes. The pelagic zone is usually regarded as the most important habitat in terms of production of organisms at the base of the food web. That pelagic production really is important is evidenced by the fact that primary production alone contributes up to one gram of carbon per m^2 and year. However, also the littoral zones may contribute significantly, especially in Lake Erken, which has a relatively high transparency. Assuming the euphotic zone extend down to four meters, which is a conservative estimate, the area covered by littoral producers would be 4.7 km^2 or some 20% of the lake area. Productivity in the emergent macrophyte and submersed littoral zones may be up to 7–8 times higher per unit of area than that of the pelagial. Hence, primary production in the littoral zone of Lake Erken may well match that of the production in the pelagial. Although Lake Limmaren has a much shallower euphotic zone, ca. 2 meters, the corresponding calculation indicates that production in the littoral zone may match that of the pelagial also in this lake.

Because of the long water renewal time and the resulting small losses of material through the outlet, most of the pelagic production will sooner or later end up in the profundal sediments (Figure 11-4). The same is valid also for most of the production in the wind-exposed and illuminated soft-bottom areas, respectively.

Far from all of the settled organic material is finally deposited in the profundal sediment. Of the sedimenting organic carbon roughly 50% is recycled by resuspension, respiration and various biological transport processes (migration, hatching of insects etc.). The fraction of other elements finally deposited in the lake varies. For example, the sediments of Lake Limmaren seem to be a source of phosphorus to the water column, while in Lake Erken the phosphorus retention calculated on an annual basis is 30%. In contrast, the retention of Cs-137 has been estimated to vary between 80 and 100% in lakes with a long water-turnover time.

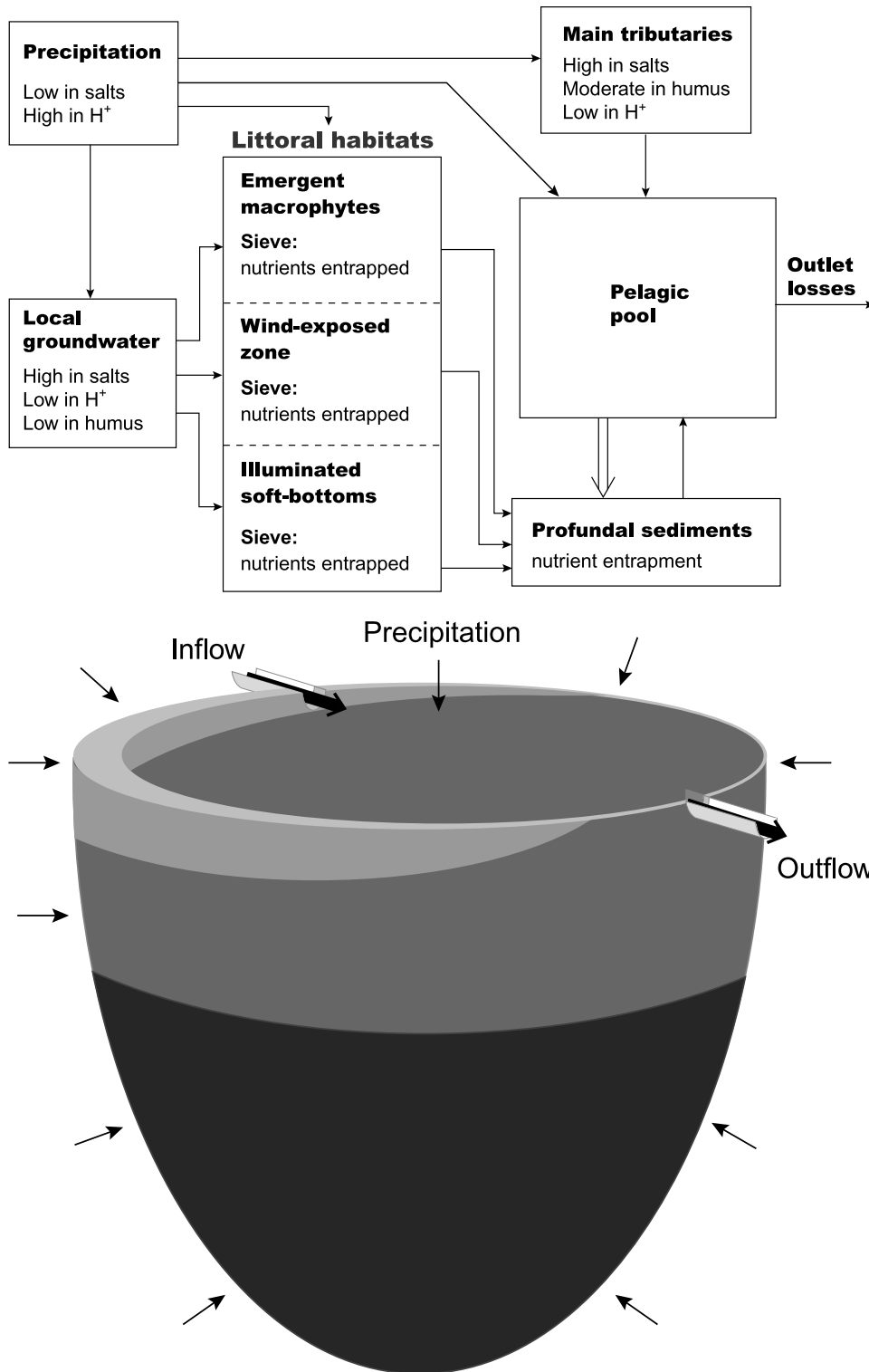

Figure 11-4. A tentative model for the functioning of the deep eutrophic Lakes Erken and Limmaren /Brunberg and Blomqvist, 2000/.

11.6 Future development

11.6.1 Ontogeny of the oligotrophic hardwater lakes in the Forsmark area

The oligotrophic hardwater lakes in the Forsmark area can from at least two points of view be regarded as being of an ephemeral nature. First of all, like all lakes, they are successively being filled with material from the drainage area and material produced in the lake basin itself, the final stage being a wetland forest or a bog. Secondly, the oligotrophic hardwater stage is also of ephemeral nature. The reason is that the exceedingly high concentrations of bicarbonates and cations, principally calcium, typically found at an early stage after the isolation of the lake basin from the Baltic Sea originates from the calcium rich glacial and post-glacial soils of the catchment basin. When isolated from the Baltic Sea and as the groundwater level descended, weathering of the soils began and this gave rise to large amounts of dissolved substances in the water. However, as the underlying bedrock consists of granites and gneisses, the storage of carbonates and base cations is restricted to the soils, which is a finite source of ions that will be depleted in a relatively short geological perspective. Regardless of the duration of the hard-water stage, it is evident that the system will sooner or later reach a point when the precipitation of CaCO_3 in the lake water will no longer take place. At that point, there will be no co-precipitation of important plant micronutrients (e.g. P) or essential trace elements (e.g. Fe, Mn). Instead, these elements, and especially P, will contribute to the production of organisms in the system and there will be a rapid change towards eutrophic conditions. This change will in turn lead to increased amounts of sedimenting organic matter (i.e. increased infilling), increased decomposition rates, at least until anoxic conditions are reached, and enhanced nutrient recycling.

A more likely ontogeny of the hardwater-lakes in the Forsmark area is that towards a reed swamp, a fen, and finally a bog ecosystem. This idea is supported by the fact that mires constitute a large part of the two principal catchments in the Forsmark area, today 8 and 17%. It is also supported by the fact that the riparian zone of most existing oligotrophic hard-water lakes in the area to a great extent is dominated by mires.

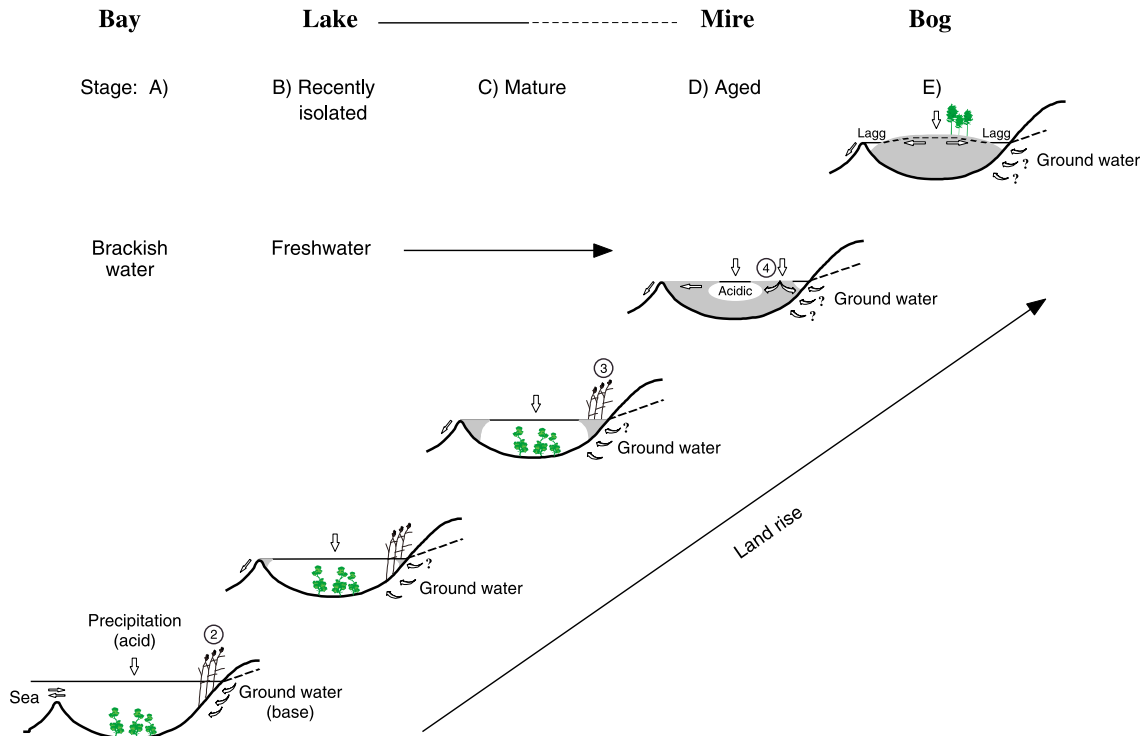

Figure 11-5a-e. Suggested ontogeny of the oligotrophic hardwater lakes in the Forsmark area. The numbers in the figure represent different major components of the ecosystem: 1 = *Chara meadow*, 2 = *Phragmites littoral*, 3 = mire/floating-mat littoral, 4 = *Sphagnum littoral* /Brunberg and Blomqvist, 2000/.

All lakes in the Forsmark area originate as depressions in the bottom of these large aquatic systems. As the land-rise proceeds, these areas are successively transported upwards to become shallow bays along the coast (Figure 11-5). Inflow of freshwater in the form of ground- or surface water begins and the system changes slowly from a brackish to a freshwater stage. In such coastal basins, there is a “threshold” in the mouth to the main part of the coastal basin. This threshold allows settling fine material to accumulate in the deepest part of the basin. At this stage, when the waterlevel is less than 2–3 meters, different *Charales* (e.g. *Chara tomentosa*) colonises the illuminated soft-bottom sediments. Along the shore, *Phragmites* and other aquatic vascular plants also begin to colonise the system and a wind-sheltered littoral zone is developed. In both these habitats, the colonisation by plants reduces the bottom currents resulting in increased sedimentation. Thus, two of the major components of the oligotrophic hardwater lakes start to develop already when the basin is a brackish water system along the coast (Figure 11-5a). The water entering the bay from the catchment will be rich in dissolved substances and well buffered as a result of the new soils being rich in carbonates and associated ions.

As the basin successively becomes isolated from the Baltic Sea, the influence of the brackish coastal water decreases and so does the salinity of the system. In recently isolated lake basins which lack major tributaries the inflowing groundwater becomes the only source of water to the system. It is probably at this stage that precipitation of CaCO_3 and co-precipitation of P, Fe, and Mn becomes pronounced. An oligotrophic clearwater system, in which the major components are the illuminated soft-bottom zone

and the *Phragmites*-dominated sheltered littoral zone, establishes (Figure 11-5b). During the proceeding succession towards a more mature oligotrophic hardwater lake stage, *Sphagnum* mosses start to colonise the macrophytes of the sheltered littoral. As the growth of *Sphagnum* proceeds in an outward direction and organic accumulation underneath these plants increases, a mire/floating-mat littoral zone is successively developed. This mire-littoral is important in that it alters the groundwater flow and/or chemistry of the inflowing water, as discussed above. Thus, the invasion of the sheltered littoral by *Sphagnum*, should, at least theoretically have a profound effect on the functioning of the lake ecosystem (Figure 11-5c), which still has two major key habitats both allocated to the bottom area. In a later stage of succession, the accumulation of organic detritus in the lake basin completely covers the previous illuminated soft-bottom area (Figure 11-5d). At this stage, the *Sphagnum* littoral alone dominates the metabolism of the system, while the previous soft-bottom habitat has been lost through sedimentation of peat. The whole system; the mire-littoral as well as the open water, is now acidic. The final stage, the raised bog ecosystem (Figure 11-5e), represents an autonomous hydrological system which is exclusively fed by precipitation on the surface of the bog and which, through the capillary capacity of the *Sphagnum* necromass, is characterised by a raised groundwater surface in the bog and an outflow of water to the surrounding ecosystems. In this situation, material from the groundwater in the catchment area is transported through the surrounding lagg.

11.6.2 Ontogeny of the brownwater lakes of the Forsmark area

From a historical and ontogenic point of view the catchment of River Forsmarksån, and thereby also its lakes, may be divided in two parts with different ontogeny; the area upstream and downstream, respectively, of the 13 m high falls at Lövestabruk.

The paleoecological studies show that Lake Vikasjön passed through an oligotrophic hardwater stage after the isolation from the sea, during which “cyanophycée-gyttja” was settled. This corresponds to the present situation in the oligotrophic hardwater lakes along the coast. This stage had a duration of about 1,000 years, and was followed by a period of 1,000–2,000 years when the lake basins successively were isolated from each other and partly were grown over by mires. The sediments in the remaining lake basins then switched to “dy” sediments due to the influence of humic compounds from the surroundings. Thus, most of the lakes in the upper parts of River Forsmarksån have a similar historical record in the sediments.

The lakes which are situated below the 13 m fall at Lövestabruk have a different history. Due to the substantial difference in the topography they were isolated from the sea at least 2,000–2,500 years later than the upstream lakes. At this time period, the upstream lakes had passed the oligotrophic hardwater stage, and were already more or less brownwater systems. The inflowing water from the upstream areas to the newly formed lakes thus was less alkaline. This water from the main river constituted a major share of the inflowing water to the newly formed lake basins. The large flow of water dominated, and still dominates, the hydrology of the system, thus diluting and washing out the contributions from the land areas in the close vicinity of the newly formed lakes. Consequently, no oligotrophic hardwater stage has been present in the chain of lakes situated along the main river below Lövestabruk. Instead they developed to brownwater flow-through lakes more or less directly after the isolation.

11.6.3 Ontogeny of the deep eutrophic lake type

The ontogeny of Lake Erken over the 10,000 coming years can be estimated. The accumulation of lake sediments in the deepest parts of the basin is maximally 1 m over the 2,500 years that have passed since the lake was isolated from the Baltic Sea. Assuming the same rate of sediment deposition, the accumulation of sediments during the coming 10,000 years would be 4 meters. The accumulation of sediments in other parts of the lake would be considerably lower. Thus, even after 10,000 years from now, Lake Erken will be a large and, for the region, relatively deep lake (maximum depth ca. 16 m).

The situation in Lake Limmaren is different. First, the sedimentation rate over the past 1,000 years has been considerably higher than that in Lake Erken, with an accumulation of some 1.4 m of sediment in the deepest part of the lake. Secondly, Lake Limmaren is much shallower than Lake Erken. Calculated for the coming 10,000 years, the accumulation of sediments in Lake Limmaren will be about 14 m, it seems reasonable to conclude that the basin will be completely filled with sediments in 5,000 to 10,000 years from now. A first transition to a reed-marsh seems very likely but whether the end station is a mire or a wetland forest (dominated by alders) is highly uncertain.

11.6.4 The formation of new lake basins in the Forsmark area during the coming 10,000 years

The formation of new lakes due to the shoreline displacement in the Forsmark area has been analysed by Brydsten (see section 4). Most of the lakes will be relatively shallow, with mean and maximum depths below 3 and 6 meters, respectively. However, a chain of large and relatively deep lakes will be isolated late (more than 5,000 years from now) along the W side of the island of Gräsö. These lakes will have average and maximum depths of more than 4 and 19 meters, respectively. Lake number 4 (in the following termed "Lake 4") has been identified as the most important since the SFR will be located in the drainage area of this lake (Figure 5-5). This lake, which will emerge about 4,900 AD, will have a surface area of 1 km², a mean depth of 1.7 m and a maximum depth of 4.1 m, thus belonging to the majority of small and relatively shallow lakes. At present, most of the catchment area is submerged, i.e. located at the bottom of the Baltic Sea. The size of its drainage area has been estimated to 29.4 km² and the water renewal time to 102 days. One of the lakes present in the Forsmark area today, Lake Eckarfjärden, will drain to Lake 4 and the catchment of this lake will represent the uppermost part of the catchment of Lake 4. The differences in elevation within the catchment of Lake 4 will be relatively small, at most ca. 30 meters. The geology of the catchment will consist of granites and gneisses covered by glacial till. The glacial till will contain more than 20% of calcareous matter in the fine grain fraction. In the following chapter, these data have been used to predict the initial lake type to be formed and, together with information about existing lakes, its ontogeny during the first thousand years after formation.

After leaving Lake 4, the water will pass through a short river north of the basin and enter a chain of tightly coupled small lakes (Lakes 5–8) before the river turns east towards Gräsö. The water from this river will then enter the large and relatively deep lakes 13 and 14 which will be isolated from the Baltic Sea some 6,800 and 7,700 years

from now. These lakes will also drain both the two existing rivers Forsmarksån and Olandsån which will join into one river less than a millennium from now and will therefore have very large drainage areas. The river draining the area including Lakes 4–8 will in comparison be relatively small.

11.6.5 Development of Lake 4, first 1,000 years

Type of ecosystem in lake 4 shortly after isolation from the Baltic

The information summarised above about the characteristics of the three main lake types can be used to predict the ontogeny of new lake basins isolated from the Baltic Sea due to the land rise, particularly that of Lake 4.

Existing data about Lake 4, and corresponding values for the three different lake types are presented in Table 11-8. In many respects, Lake 4 will be most similar to the brownwater lakes of River Forsmarksån, eg lake area, average depth, and maximum depth. However, Lake 4 will have almost twice the volume of water of the brownwater lakes and, consequently, the water renewal time will also be substantially longer. In other respects, Lake 4 is more similar to the hardwater lakes. The drainage area of Lake 4 is considerably smaller than that of the brownwater lakes, and the average calcium content of the surface soils in the drainage area is very high, exceeding 20%.

From this comparison, Lake 4 takes an intermediate position between the brownwater and hardwater lake types.

By considering which characteristics of the are coupled to lake morphology, it is possible to refine the prediction. The key features of the three different main lake types with respect to morphometry and drainage area characteristics are presented in Figure 11-6.

Table 11-8. Lake morphometry and drainage area characteristics of Lake 4 compared to those of the three main lake types present today along the coast of the province of Uppland. For hardwater and brownwater lakes the figures represent median values from Tables 11-1, 11-4 and 11-6.

Lake	Area, km ²	Average depth, m	Maximum depth, m	Volume, Mm ³	Water renewal time, days	Catchment area, km ²	Ca in soils %
Lake 4	1.06	1.7	4.1	1.8	89	29	>20
Hardwater	0.07	0.9	2.0	0.07	240	1,9	>20
Brownwater	1.14	1.5	2.7	1.0	31	106	<6
Erken	24.2	9.0	20.7	213	2,700	141	?
Limmaren	5.9	4.7	7.8	27	2,140	21	?

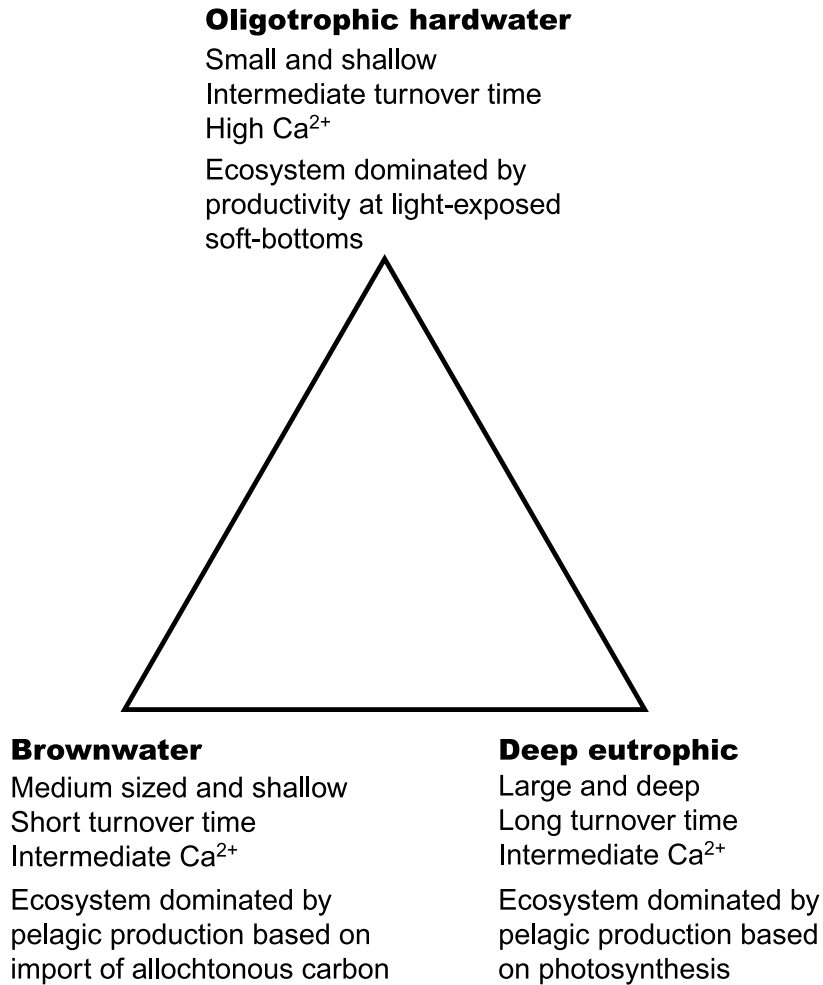

Figure 11-6. Characteristics of the three different lake types in the Forsmark area /Brunberg and Blomqvist, 2000/.

Lake 4 is similar to the hardwater lakes in that it will be small and shallow, and its drainage areas will be characterised by very high calcium content of the surface soils. As a result of these characteristics, the water, which is rich in dissolved salts, is relatively clear and large parts of the sediments have light enough to develop a soft-bottom habitat dominated by photosynthesising organisms. This is the key habitat in the lake, functioning as a filter for inflowing groundwater entrapping nutrients and base cations via biological uptake and/or precipitation followed by storage in the sediments. Based on these considerations, it seems likely that this new lake will undergo an oligotrophic hardwater stage just after formation.

However, water turnover time of Lake 4 is more similar to the brownwater lakes. Turnover time is another key factor for the development of the hardwater stage, and is, in turn coupled to the colour of the water. The moderate turnover time indicates that the water colour will be considerable already at lake formation. Notably, the lakes that were formed in River Forsmarksån below the 13 m high falls at Lövstabruk do not seem to have passed through an oligotrophic hardwater stage, despite their relative shallowness. The most likely reason is that the water colour initially was high enough to prevent light from penetrating to the soft-bottom sediments.

A factor that must be coupled to the inflow of humic matter to the lake ecosystem is the time of isolation of major parts of the drainage area, since the presence of humic matter is a function of the percentage of mires in the area. Large parts of the drainage area of Lake 4 will be isolated from the sea only shortly before isolation of the lake itself. Therefore it seems unlikely that mires would have developed to such an extent that the water colour at lake formation would be high enough to prevent light exposure of shallow sediments. Summarising this knowledge it seems likely that Lake 4 will undergo an oligotrophic hardwater stage shortly after formation, although the duration of this stage may be shorter than that of the existing hardwater lakes.

Both the existing brownwater and hardwater lakes in the Forsmark area show a successive growth of mire around the lake basin, which results in the formation of a *Sphagnum*-littoral habitat at the border between the mire and the lake. There is no reason to believe that Lake 4 would deviate from this pattern. Whether this habitat functions as a sieve for nutrients and cations in the inflowing water or as a dike under which groundwater from the soils of the drainage area has to pass to reach the lake is uncertain. There is most likely to be a successive change in the function of the *Sphagnum*-littoral, from being a sieve to being a dike. The function of the habitat will determine the entrapment of nutrients (as well as eventual contaminants) from the inflowing water.

The presence or absence of open watercourses through the system is another important difference between the hardwater and the brownwater lakes. Depending on the character of the system, nutrients (and contaminants) can either be trapped or exported to downstream localities. Lake 4 most likely will take an intermediate position in this respect.

Assuming that Lake 4 does not function as a trap for contaminants, these substances will flow via a chain of smaller lakes (Lakes 5-8, Figure 5-7) and end up in the larger and deeper basins 13 and 14. These large lakes have morphometrical characteristics similar to those of Lakes Limmaren and Erken. A considerable difference between Lakes 13 and 14 and Lakes Erken or Limmaren will be that the drainage area of these new lakes will be very large. As a consequence, the turnover time of the water will be much shorter than that of Lakes Erken and Limmaren and the water colour will be much higher. The turnover time of the water in these lakes would be about 40 days. Hence, in this respect Lakes 13 and 14 will very much resemble the brownwater lakes, with highly stained water and a thin productive layer. It seems unlikely that these two lakes will concentrate contaminants in the sediments. Instead, most of the material entering these lake basins will be transported further downstream, i.e. to the Baltic Sea.

Altogether, during the first millennium after formation, it seems likely that nutrients and contaminants entering the drainage area of Lake 4 will be trapped in the *Sphagnum*-littoral or in the microbial mat on the illuminated soft bottoms, especially if entering the lake basin directly via the groundwater. If entering the lake basin with the relatively small river, a considerable share will most likely be transported further downstream to the Baltic Sea. In later developmental stages the functioning of the lake ecosystem of Lake 4 will most likely change due to the growth of mire around the basin.

Development during first 1,000 years after isolation

Assuming that Lake 4 directly after isolation develops into an oligotrophic hardwater lake, the ontogeny of its basin will principally follow that of the oligotrophic hardwater

lakes described in Figure 11-5. During the first 1,000 years, the system will be characterised by one key habitat of major importance to the turnover of nutrients and other ions in the system, i.e. the light-exposed softbottom zone. Successively another important habitat will develop; the mire-littoral zone dominated by *Sphagnum*. As long as the formation of peat between the bottom of the lake and the *Sphagnum*-littoral is not complete, this habitat will most likely function as a sieve for inflowing groundwater and thus accumulate eventual contaminants. Later, when the habitat is well developed, it may act as a dike and force inflowing groundwater to enter the lake basin after passage underneath the peat layer. Also in that case, the microbial mat on the illuminated soft-bottoms will act as a sieve and nutrients and other material will still be trapped in the basin. During later developmental stages, when the mire completely covers the basin and is in the process of developing into a bog, the former lake basin will most likely function as a flow-through system, in which water, nutrients, and contaminants are passing through along the open water in the lagg which creates the border between the wetland and the dry terrestrial ecosystems. The duration of the different developmental stages of Lake 4 is difficult to assess, as no data on growth of mires in this area are available. However, the duration of the oligotrophic hardwater stage in Lake Vikasjön in the upper part of the River Forsmarksån has been calculated to about 1,000 years, based on paleo-ecological studies of the sediments. From the same investigation, sedimentation rates have been calculated to 1–1.5 mm per year during the oligotrophic hardwater stage and 1 mm per year during the following brownwater stage. Applying these values to Lake 4, and assuming a similar duration of the oligotrophic hardwater stage, the life span of Lake 4 may be predicted to at least 3,600 years. This calculation does not include the effects of mire growing into the lake. The effects of the growth of mire may be that the life span of the lake is shortened, but it may as well counteract the process of filling out by enhancing the lake threshold if the mire grows also within the outlet. However, the latter process may be of less importance in this case, as Lake 4 will have a substantial flow-through of water (estimated water renewal time 89 days, Table 11-8).

Finally, it must be stressed that although the theoretical models about the functioning of the brownwater lakes and the hardwater lakes, the facts behind the models to a great extent remains to be verified. The discussions and conclusions regarding the fate of contaminants that eventually may enter the lake systems are thus highly speculative.

11.7 References

Brunberg A K, Blomqvist P, 1999. Characteristics and ontogeny of oligotrophic hardwater lakes in the Forsmark area, central Sweden.
SKB R-99-68, Svensk Kärnbränslehantering AB

Brunberg AK, Blomqvist P, 2000. Post-glacial, land rise-induced formation and development of lakes in the Forsmark area, central Sweden.
SKB TR-00-02, Svensk Kärnbränslehantering AB

Forsberg C, 1965. Environmental conditions of Swedish Charophytes.
Symb Bot Ups 18:4

Tabell 11-9. Water biology of the three types of lake in the Forsmark area. /Data from Brunberg and Blomqvist, 2000/

Habitat	Oligotrophic hardwater lake	Brownwater lake	Deep eutrophic lake
Pelagial	<p>Very low production, limited by P availability and availability of micronutrients, especially Fe and Mn.</p> <p>Low phytoplankton biomass due to oligotrophic conditions. Chrysophyceae dominate, green algae and cryptophytes also important. Dinoflagellates and diatoms. Few cyanobacteria due to lack of Fe.</p> <p>Bacterioplankton production expected to be as big as, or exceed, phytoplankton production because of available allochthonous organic carbon in the lake water and the low P concentrations, which favours smaller organisms.</p> <p>Zooplankton biomass expected to be low.</p> <p>Number of species and individuals of nektonic invertebrates expected to be low due to presence of fish</p>	<p>Most important habitat with respect to total production in brownwater lakes.</p> <p>Primary production is low, limited by extinction of light caused by humic substances, and by competition with bacteria for available inorganic nutrients. Total P concentrations moderate, but P associated with humic substances unavailable for organisms.</p> <p>Phytoplankton biomass low, but highly variable due to presence in some lakes of rare species (e.g. <i>Gonyostomum</i>). May be higher in Forsmark area than in this type of lake in general. Phytoplankton dominated by chrysophytes and cryptophytes. Also present are green algae, cyanobacteria and some diatoms.</p> <p>Zooplankton dominated by fine-particle feeders, eg cladocerans, rotifers and ciliates.</p> <p>Bacterioplankton and metazooplankton may have biomass as high as, or exceeding, phytoplankton. Production at the base of the food web relies to a large extent on bacterial utilisation of allochthonous organic compounds.</p>	<p>Most important habitat in these lakes with respect to total carbon production. Phytoplankton dominate the biota (diatoms and cyanobacteria are the dominant components, with chrysophytes and dinoflagellates under certain conditions) and phytoplankton productivity is high.</p> <p>Bacterioplankton production relies on phytoplankton derived organic carbon as there is little allochthonous organic material. Bacterioplankton have a biomass 27% of that of phytoplankton in summer and have a production of 20% of the primary production.</p> <p>Pelagic biota utilise a large part of the primary production. Primary consumers are omnivorous zooplankton, mainly crustaceans. The biomass of heterotrophic bacterioplankton and zooplankton is expected to be fairly high, almost as high as that of phytoplankton. The remainder of the primary production is lost to the profundal zone by sedimentation. Because of the long water renewal time, losses through the lake outlet are small.</p>

Habitat	Oligotrophic hardwater lake	Brownwater lake	Deep eutrophic lake
<p>Littoral - emergent macrophyte</p>	<p>Continuous shift from complex mire system of riparian zone to an often floating outer edge.</p> <p>Floating character caused by <i>Phragmites</i> whose air filled roots become detached from the substrate. Floating mats are then colonised by <i>Sphagnum</i> mosses, which dominate these systems.</p> <p><i>Sphagnum</i> and <i>Phragmites</i> do not form food source for aquatic herbivores (<i>Sphagnum</i> is not eaten by other herbivores either)</p> <p>Microflora biomass very low, due to shading by <i>Sphagnum-Phragmites</i> stands.</p> <p>Decomposers (bacteria and fungi) expected to be important producers of organic carbon for higher trophic levels, as habitat is rich in organic matter,</p> <p>Access for larger benthic fauna (eg insect larvae, crustaceans, molluscs) is restricted by compact structure of <i>Sphagnum- Phragmites</i> stands.</p>	<p>Similar in nature to that in oligotrophic brownwater lakes, though the outer zone is dominated by <i>Phragmites</i> (covering 30–50% of lakes surface)</p> <p>Very little photosynthetic production in the water, due to restricted light penetration caused by shading and by strong water colour. Heterotrophic organisms expected to be important, utilising the released organic substances and forming an important link to higher trophic levels (e.g. benthic fauna and fish).</p> <p>Influence of emergent macrophyte zone on lake water chemistry and contribution to lake turnover of carbon an nutrients is smaller than in oligotrophic hardwater lakes, and depends on hydrology, i.e. balance between flow through of river water and inflow of water through littoral zone</p>	<p>Habitat is smaller, but more productive than the open water. Dominated by <i>Phragmites</i> in dense 4-5m high beds. Sediment environment is highly variable, with diurnal changes in temperature, concentrations of dissolved oxygen, nutrients etc.</p> <p>Rich and highly diverse periphyton community colonising the macrophytes, including microalgae, cyanobacteria, heterotrophic bacteria, fungi, protozoa, nematodes. Larger benthic organisms graze the biofilm, e.g. smalls, insect larvae, crustaceans.</p> <p>Production of the emergent macrophyte habitat is high. Primary production may exceed pelagic phytoplankton production by a factor of 5-8.</p> <p>This zone gives important shelter to fish fry.</p>

Habitat	Oligotrophic hardwater lake	Brownwater lake	Deep eutrophic lake
Littoral – Wind exposed	Missing (lakes too small)	Missing (lakes too small)	<p>Stony substrate dominated by macroalgae, especially <i>Cladophora glomerata</i> in dense belts close to the shoreline. Macroalgae have a productive and diverse epiphyton, including diatoms and other microalgae. Primary production of the epiphyton can exceed that in the pelagic zone by up to 6 times per unit area. A highly productive habitat. Organic matter produced is respired or lost to the profundal zone, very little organic matter accumulation. Benthic fauna dominated by omnivorous organisms scraping the rich flora off the substrate, eg snails .</p> <p>Zebra mussel (non-native species) can be a major constituent in some lakes and have the potential to affect many of the organisms in the plankton.</p>
Light exposed, softbottom zone	<p><i>Chara</i> meadows, consisting of high standing stock of submersed macrophytes; <i>Charales</i>. <i>Charales</i> are able to withstand high H₂S levels in sediments. They are restricted to highly calcareous and nutrient poor water, using HCO₃⁻ in photosynthesis and precipitated calcium carbonate for support in cell walls. Decomposition of <i>Charales</i> is slow, therefore retention of nutrients, especially P, is high.</p> <p><i>Chara</i> meadows stabilise sediments, provide protection for other organisms and a substrate for scrapers feeding on the microbial biofilm of plants . Overwintering <i>Charales</i> favour slow colonisers. Cladocera, gostropods, gammarids, isopods and some chironomids are abundant.</p> <p>Unusually thick microbial mat (10–20 cm) on top of soft sediments. Very diverse microbial community (photosynthetic and non-photosynthetic), including cyanobacteria, algae phototrophic sulphur bacteria, heterotrophic bacteria, fungi. Almost all microbial production occurs in this zone. Production of heterotrophs is high as soft bottom zone is rich in organic matter from both <i>Chara</i> meadows and surrounding <i>Sphagnum/Phragmites</i> mire system</p>	Missing due to strong colour of water	<p>No macrophytes. Photosynthesising organisms are cyanobacteria, diatoms and in some areas green algae e.g. <i>Cladophora aegagrophilia</i>. Productivity unknown, but likely to be a substantial contributor to total productivity.</p> <p>Benthic fauna community rich in individuals, dominated by Asellus. Not clear whether this high production at high trophic levels indicates substantial primary production within the habitat, or whether the carbon supply is imported from the pelagic zone.</p>

Habitat	Oligotrophic hardwater lake	Brownwater lake	Deep eutrophic lake
Profundal	Missing (lakes shallow and clear)	<p>Least productive of the three habitats, though form the dominating habitat due to restricted light penetration in the strong coloured water.</p> <p>Benthic organisms include macro-, meio- and microfauna, heterotrophic bacteria and fungi. Macrofauna includes insect larvae, molluscs, crustaceans and other invertebrates.</p> <p>Benthic organisms decompose and utilise organic carbon imported to this habitat by sedimentation. About 30% of the sedimenting carbon is lost by respiration. Sediments have high organic matter contents, though much of the organic matter is not readily decomposable and concentrations of important nutrients are depleted. Therefore biomass of benthic fauna is low. <i>Chironomid</i> larvae dominate species composition.</p>	<p>Recipient of settling autochthonous matter from rich pelagic production. A large proportion of the added carbon is lost by respiration processes and transfer to higher trophic levels of the profundal zone. Amount of autochthonous material varies seasonally in amount and quality, though the material is more readily decomposable by benthic organisms than the allochthonous material in brown water lakes. The benthic fauna have a higher biomass and diversity than the brownwater lakes. The benthic biota is highly dynamic, responding to seasonal variations in organic matter input.</p> <p>Some of the carbon is recycled to the lake water by recruitment (plankton). 5–7% of the pelagic biomass is recruited from the sediments. Other processes transporting carbon back to the lake water are migration of fish between lake habitats and hatching of insect larvae.</p> <p>Up to half of the yearly sedimentation of carbon may be permanently buried in the sediments.</p>
Fish	Few individuals and few species, though biomass is high. 6 species encountered: roach (<i>Rutilus rutilus</i>), Crucian carp (<i>Carassius carassius</i>), tench (<i>Tinca tinca</i>), perch (<i>Perca fluviatilis</i>), ruffe (<i>Gymnocephalus cernua</i>), and pike (<i>Esox lucius</i>). Crucian carp dominates in many of the lakes, indicating poor oxygen conditions during winter in these small, shallow lakes.	<p>Relative diverse fish community, including all species expected to occur in lakes in this part of the country. Poor in abundance and biomass. Total of 9 species encountered; pike (<i>Esox lucius</i>), roach (<i>Rutilus rutilus</i>), perch (<i>Perca fluviatilis</i>), ruffe (<i>Gymnocephalus cernua</i>), bream (<i>Abramis brama</i>), white bream (<i>Blicca bjoerkna</i>), rudd (<i>Scardinius erythrophthalmus</i>), tench (<i>Tinca tinca</i>) and Crucian carp (<i>Carassius carassius</i>).</p> <p>Perch dominates in most lakes.</p>	<p>Diverse and productive fish community including all species typical of lowland lakes and, in addition, pelagic planktivores and their predators. At least 16 different species, with dominance of perch (<i>Perca fluviatilis</i>), roach (<i>Rutilus rutilus</i>), smelt (<i>Osmerus eperlanus</i>), ruffe (<i>Acerina cernua</i>), pike (<i>Esox lucius</i>), burbot (<i>Lota lota</i>) white bream (<i>Blicca bjoerkna</i>), and bleak (<i>Alburnus alburnus</i>).</p>

12 Human society

The activities of humans are an important parameter in the safety assessment. Most parameters are generic and summarised in the data report /SKB, 2001/ and the exposure model /Karlsson et al., 2001/. Some parameters site specific and are compiled below.

12.1 Population

Östhammar municipality is quite small and most of the inhabitants live in urban areas. The greatest population density in the municipality is in the south-west, because of the nearness of the urban areas of Uppsala and Arlanda/Märsta. The following values for population density in Östhammar are taken from /Strömqvist and Pleiborn, 1996/.

Population, total	22,500
Population in urban areas	14,500 (64%)
Population per km ²	15.5

The coastal area of Östhammar municipality has many visitors in the summer and many summer cottages are located close to the Baltic Sea. However, the population density for rural areas is more relevant to the SFR region than that of urban areas. The area nearest to SFR (the parish of Forsmark) has a very low population density of only 1.1 inhabitant per km². The population density of the Forsmark area (data from SCB) is shown in Figure 12-1.

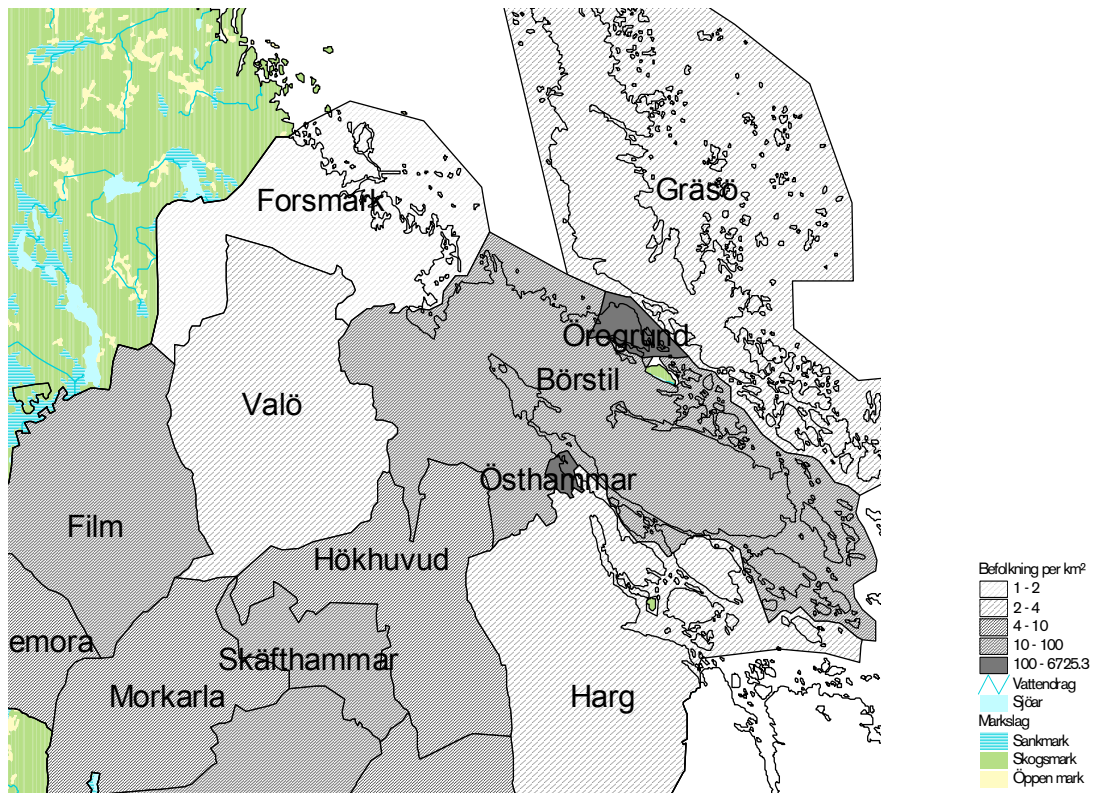

Figure 12-1. Density of permanent population in the Forsmark area (data from SCB).

12.2 Farming practices

Because of the thinness of the soils in the area, farming is not expected to be important in the Forsmark area. The soils are usually drained lakes or mires. Section 10-1 on the surrounding land discusses the present land use and outlines the assumptions made concerning future land use.

12.3 Wells

12.3.1 Introduction

Knowledge about wells is important for the safety analysis. One of the most important exposure pathways for radionuclides comes from wells /cf. Karlsson et al., 2001/. Drilled wells are critical since they short-cut flow paths to the biosphere from the geosphere. Moreover, drilling a well can also be a potential intrusion into the repository, adding potential exposure by transporting particles as drill residues to the surface and affecting the repository performance. Fortunately drilled wells are documented through the Swedish well archive, which covers all legally drilled wells and the majority of

the drilled wells in the area. Dug wells are, however, seldom documented, but are mainly fed by surface water. This section reviews the existing information from the well-archive about drilled wells in the Forsmark area and surrounding region and analyses of the possibility to drill new wells in the future.

12.3.2 Spatial distribution of wells

The spatial distribution of drilled wells in the area surrounding SFR is shown in Figure 12-2. The average density of wells in the area closest to SFR (approx. 400 km²) is 0.2 wells/km² and the maximum is 0.9 wells/km², cf. Figure 12-2 lower panel. In the larger regional area (approx. 3,300 km²), covering popular coastal resorts the average is 0.5 wells/km² and the maximum is nearly 2 wells/km², Figure 12-2, upper panel. The distribution is uneven and some coastal sites have the highest densities (Figure 12-2). The sites are usually located at rocky sites and near old existing settlements, usually good natural harbours. The majority of the coastal sites are summer cottages. The area around SFR has a very low density, dependent on the low population along the shore and inland. The area has not been popular in the past and in recent time due to the lack of coastal rock sites, flat topography and boulder rich till and the wave and wind exposed coast. This made the site unsuitable as shelter for boats, for farming unattractive and unattractive for summer cottages. The building of the nuclear power plant in Forsmark has also reduced the interest and possibility in this area for summer cottages. The distribution of the wells is dependent on the proximity to the shoreline due to several reasons.

- The popularity of the coast, moving close to the sea.
- The probability of saltwater intrusion in the well, avoiding places close to the sea.
- Houses are usually built some distance from the shore, to provide shelter from the sea, high tides and also because of legal constraints.
- Steep slopes or high elevation of the coast, reduces the distance to the shoreline for a suitable well.

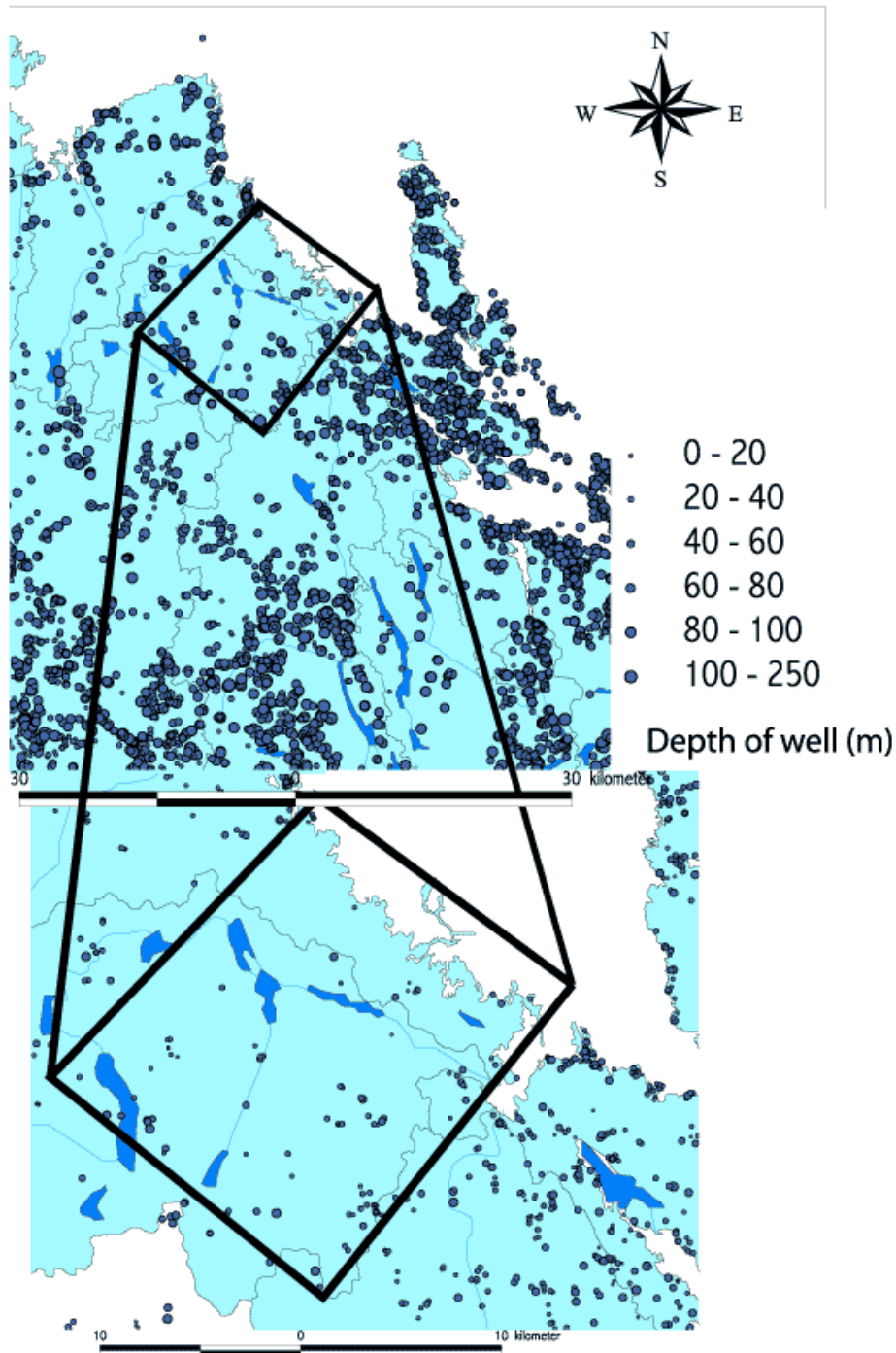

Figure 12-2. Drilled wells in the coastal region of Northern Uppland (upper map) and of the area surrounding SFR (lower map). The size of the symbol illustrates the depth of the well. Data from the Swedish Well archive, SGU.

12.3.3 Temporal distribution of well

The proximity of well to the shore is dependent on several factors as outlined above. One of the best descriptors of near shore wells is the elevation above sea level. This is also an indicator of how much time has elapsed after the shore-line has passed by the

site before a well is drilled. Thus the density of wells can be estimated to be dependent on the age of the land the well is situated on. In Figure 12-3 this relationship is shown for the area around SFR.

The density increases gradually the first 1,800 years, from 0.03 wells/km², 0.5 wells/km² at 1,000 years and at about 1,800 years from shoreline 0.9 wells/km² (Figure 12-3a) Thereafter the density declines. For the regional area the density of wells at about 2,000 years and thereafter declines with values below 0.5 wells/km² (Figure 12-3b).

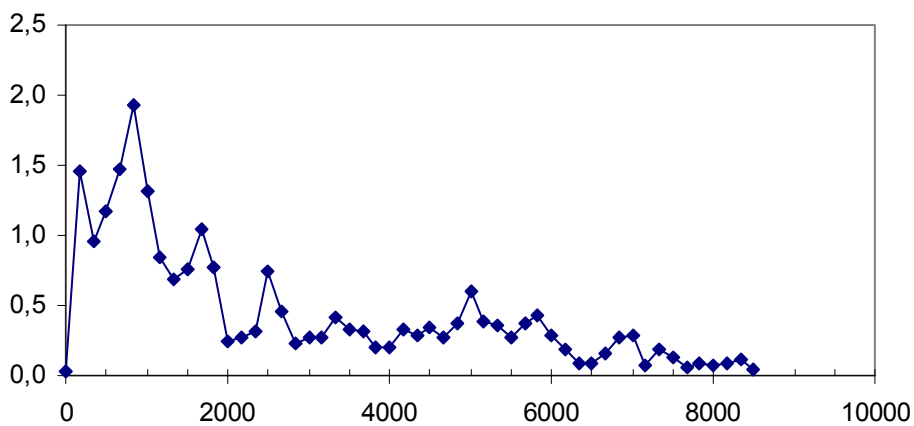
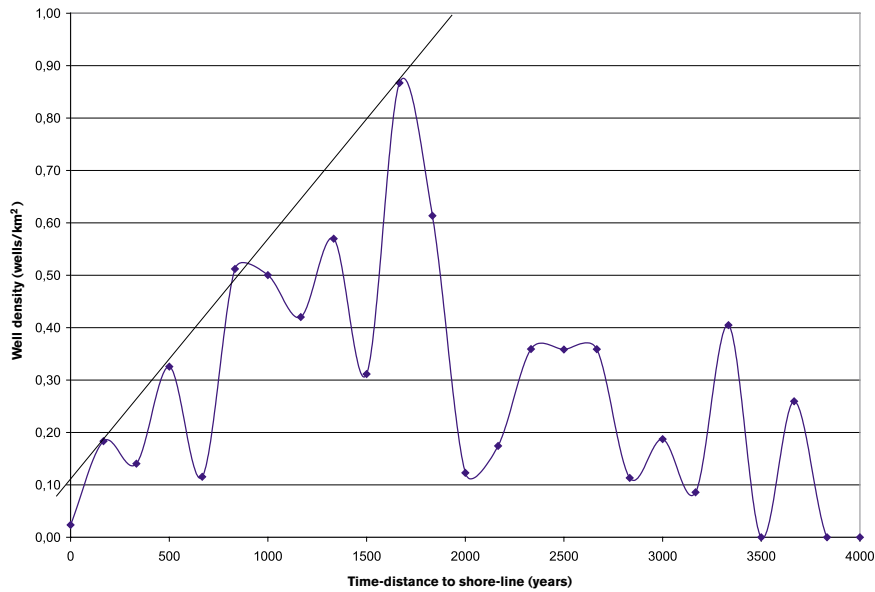

Figure 12-3. Upper: The density of wells in the area surrounding SFR (cf. Figure 12-2) and its distance from the shore expressed as years from retreat of shoreline. Line indicates the maximum well density the first 200 years. Lower: The same relationship for the coastal area of northern Uppland.

12.3.4 Future wells in the repository area

Based on the best available information, outlined above, it is assumed that future drilling activities have the same distribution regarding distance to the shore and elevation. This means that maximally 0.5 new wells/km² are drilled after the first 1,000 years in the repository area and maximally 0.9 wells/km² after 1,800 years. This assumes that the shore-line displacement has the rate as described in Chapter 5.

12.4 References

Karlsson S, Bergström U, Meili M, 2001. Models for dose assessments. Models adapted to the SFR-area, Sweden.
SKB TR-01-04, Svensk Kärnbränslehantering AB

SKB, 2001. Project SAFE – Compilation of data for radionuclide transport analysis.
SKB R-01-14, Svensk Kärnbränslehantering AB

Strömqvist U, Pleiborn M, 1996. Förstudie Östhammar, Konsekvenser för bosättning och sysselsättning.
SKB PR D-96-021, Svensk Kärnbränslehantering AB

13 Future – a synthesis of the general development of the surface ecosystems

This chapter summarises the previous chapters and the supporting documents to provide a consistent and reasonable picture of the development of the biosphere up to the next 10,000 years, based on the understanding of the biosphere today. Of course, the uncertainties will increase dramatically with the time in future.

Land uplift, climatic change and slow, local processes such as vegetation succession and the filling of lakes by sediment and the growth of vegetation from the lakeshores are the most important processes with respect to biosphere development.

13.1 Climate

Short-term changes in climate are difficult to predict. A large part of the expected climatic change, e.g. change due to the greenhouse effect, falls within the range of between-year variation. Climatic change will result in a change in the amount of runoff. On a large scale and in the long term, changes in runoff will lead to a change in the salinity of the Baltic Sea. Changes in salinity will affect water turnover, and also the species composition in Öregrundsgrepen. A 1‰ higher salt concentration will lead to the development of ecosystems similar to those at current in the Baltic proper, with higher biomass and production, and increased importance of seaweeds such as bladderwrack (*Fucus vesiculosus*) and filtering organisms like the blue mussel. A 1‰ lower salt concentration will lead to the development of an ecosystem similar to those occurring further north in the Baltic Sea, with lower biomass, lower production, few filtering organisms and little bladderwrack.

The most persistent and dramatic change is expected to be the next ice age, which starts as a colder climate in about 5,000 years. An ice age will result in a lowering of the sea level, which will accelerate shoreline displacement to about double the present rate. However, when this occurs, the shoreline will already have passed over the SFR area, which will be on land. The colder climate will also result in a reduction in precipitation. At the same time, evapotranspiration will be reduced because of the lower temperatures. The relative size of these changes will determine whether the runoff increases or decreases. Increased runoff will facilitate the growth of peat, whereas drier conditions will slow down the peat growth rate. A successive change to more taiga-like vegetation can be expected. If permafrost develops, the vegetation will change successively to tundra vegetation. Agriculture is not expected under these conditions, the main exploitation will be hunting, fishing and gathering of berries. Under these conditions, the large lakes that will develop to the east of Gräsö may be important food sources.

13.2 Shoreline displacement and lake development

The most important changes expected to occur in the repository area in the future are due to shoreline displacement and the consequent processes of lake development and their eventual infilling. Land uplift gives rise to new islands and an area of protected archipelago. This results in a change in the sedimentation conditions. Shallow, exposed areas, which are subject to erosion, are created. On the other hand, large areas of shoreline will be protected from erosion by the newly-formed archipelago and sedimentation is expected to increase in the protected waters. The water turnover within the archipelago will be reduced, which will result in increased retention of substances, including radionuclides, within the area. The shallower water will give rise to an alteration in the biological community. The total biomass will decrease because of the decrease in the water volume and bottom area. In addition, the proportion of plant biomass will increase. When sea areas are cut off, the consequent change in salinity gives rise to dramatic changes. The type of lake formed is determined by the drainage from the surrounding land and upstream river systems. Sedimentation and ingrowth of shoreline vegetation leads to the development of fens and, eventually, bogs. These former lakes or mires can be drained and cultivated if the sediment layer (with fine sediment or peat) is thick enough. Alternatively, vegetation succession can continue, ending in the development of forest areas.

13.3 The first 1,000 years (to 3,000 AD)

Neither the local model area nor Öregrundsgrepen will undergo dramatic changes in the first 1,000 years. In the model area, the water-area will decrease by 20% and the maximum depth will decrease by 6 metres. The total water turnover can decrease somewhat. The proportion of accumulation bottoms will increase from about 20% to about 40%, as the erosion bottoms disappear due to shoreline displacement. The decrease in total biomass in the area is expected to be marginal, as the total decrease in biomass will only be 20% by the year 4,000 AD. The discharge zones for groundwater from SFR will be on the seabed throughout this period. At the end of this period, the shoreline will pass over the repository, which will affect the size of the discharge zones.

13.4 3,000 AD–4,900 AD (archipelago development)

Continued shoreline displacement during this period results in the former discharge zones being situated on land. The development of vegetation on the newly formed land also begins. A large number of islands will arise, which coalesce at the end of this period, cutting off a number of lakes from the sea. The sea area in the model area decreases to 50% of its present size by 4,000 AD. The water volume decreases with 90% and the water retention time increases by about 13 days from a previous retention time of only 1 day. The narrow Öregrund strait will be closed about 3,000 AD and the water retention time in Öregrundsgrepen will be increased by about 5 days by 4,000 AD.

The change in bottom area and water volume in the local model area affects the plant and animal communities. The total biomass decreases by about 20%, but the proportion of bottom fauna and their grazers increases by about 60% due to the increase in the area of sunlit bottoms. Benthic fauna on soft bottoms is reduced by 50–80%. The biomass of pelagic plankton will be reduced by 50%, though the species composition is not expected to change.

The turnover of matter will also be affected. The increase in bottom flora will result in an increase in the total primary production by about 10%, whereas decomposition will be reduced to about 20 % of the present rate. This may result in a larger export of excess production from the area at 4,000 AD compared to 2,000 AD but probably also in an increased sedimentation of organic matter due to the slower water exchange rate that is expected in the future ecosystem.

The increased retention of matter within the model area in the year 4,000 AD compared with the present day will most probably lead to an increased retention of the radionuclides associated with organic material, mainly in the sediment.

The area of land will increase. Generally, deciduous forest will develop in the areas nearest the shoreline, whereas coniferous forest increases in importance with time and inland, as the ground becomes drier. In the lower areas, lakes will develop. However, most of the lakes will be shallow and therefore will develop quickly to mires as a result of ingrowth of vegetation from the lakeshores and infilling of organic sediments. The mires will eventually develop to forest. As the sediment- and peat layers will be thin, and the ground will be rich with large boulders, the drainage and cultivation of these former lakes is unlikely.

The discharge zones may continue to be the lower points of the topography of the newly-arisen land areas. This will occur if there is no significant change in topography. The groundwater level will probably be higher because of the accumulation of organic material in the fens and bogs, which will shift the discharge zones towards the shoreline. The discharge zones can reasonably be expected to follow the shoreline and a large proportion of the groundwater will probably be discharged direct into the sea and the newly-formed archipelago. Radionuclides that accumulate in the sediments of earlier discharge can remain in the newly-formed land. However, radionuclides that have been sedimented out from the water column to the sediment layers will probably be redistributed by resuspension as land uplift proceeds. The resuspended material can be resedimented in deeper areas, or be washed out from the model area to other parts of Öregrundsgrepen.

For the first time, it becomes possible to drill wells in the repository area. The drilling of wells is assumed to follow shore-line displacement and occur at the density found in the Forsmark area today.

13.5 4,900 AD–7,500 AD (lake development)

Several bays near to SFR will be cut off from Öregrundsgrepen around 4,900 AD, forming lakes. In the local model area a lake of about 1 km² will be formed, with an average depth of 1.7 m and a maximum depth of 4.1 m. The lake is deep enough (>2 m) for the process of ingrowth by vegetation to be retarded during the first 2,000–3,000 years after formation. The change to freshwater conditions from brackish water conditions will affect the turnover of water and material, the environmental chemistry and the structure of the ecosystem.

Water turnover is determined by the size of the catchment area and the calculated runoff assuming present day climate. The catchment area will be relatively small for a lake of this size and no larger watercourse is expected to flow through the area, as the rivers Olandsån and Forsmarksån are expected to flow through the lake system created further to the east. (see Figure 5-7). Based on the types of lake with similar catchment areas and morphometries in the area today, the lake is expected to be an oligotrophic hardwater lake. The high alkalinity of the lake is a result of the effect of the calcareous quaternary deposits effect on the groundwater. The oligotrophic hardwater lakes in this area are characterised by a high rate of sedimentation of “alggjyttja” and by hard, clear water. The lakewater can be attractive as drinking water, and can support a high fish production. However, the lake will be too small for its fish production to be important. The high calcium carbonate content results in very little bioaccumulation of radionuclides such as cesium and the dilution of ¹⁴C by stable carbon atoms of the carbonates. The lifetime of the lake is expected to be 2,000–3,000 years. As the ingrowth of vegetation, especially *Sphagnum* mosses, proceeds, the lake is expected to change in character to a brownwater lake. It is possible that lake will be drained for agriculture, as it will be the only part of the area where the sediment layer is thick enough to support crop growth. If the lake is not drained, peat growth will occur.

As the lake lies within the model area, radionuclides leaving the repository will either pass through the lake bottom or will be discharged within the lake's catchment area. It is likely that for a time, the discharge zone will be in the lake. The lake sediments are therefore potential accumulators of radionuclides as a result of two processes. Firstly, as a result of the groundwater flowing through them in the lake stage. Secondly, as a result of the resedimentation of contaminated sediments from earlier discharge zones during the stage when the lake was a bay of the Baltic Sea. In the lakes downstream of the model area, erosion of the bottom before isolation from the sea can be significantly greater. The material that sedimented in these depressions will therefore be resuspended and transported to the deeper areas of Öregrundsgrepen.

Changes in the vegetation on land within the local model area will be slight during this period, as the shoreline displacement slows down when the lakes have been developed. A succession from the earlier deciduous wooded shoreline to a forest dominated by coniferous forest is expected. Areas suitable for agriculture are not expected as the ground is stony and lacking in thicker soils derived from fine-sediment of organic deposits.

Wells can be drilled in the area at a density equivalent to that found today. It is possible that the lake in the local model area can be an attractive water supply, as the demand for water is not expected to be high. As a result of the limited opportunity for establishment of self-sufficient farming units, it is likely that the area will be very like that seen today a few kilometres inland of Forsmark, with low population density and low well density.

13.6 7,500 AD– (land period)

After 7,500 AD, the whole of the former Öregrundsgrepen will have become land, with a number of large, deep lakes along the west of the present island Gräsö. The lake in the local model area is expected to have been filled by sediment/vegetation and have been drained. The sediments of former lakebed are probably the only part of the model area with the potential to support agriculture. The former lakebed may have accumulated radionuclides that have been transported in the groundwater from the repository after its closure. The terrestrial vegetation will be dominated by forest, with a large proportion of coniferous trees. The greatest radiological consequences are therefore expected to result from the exposure of people farming the former lakebed.

There are large uncertainties associated with the predictions of the nature of the biosphere in this period, as land uplift and the sealevel have a large effect on shoreline displacement. Erosion of the unconsolidated deposits on land as well as uneven landuplift can affect the relatively flat topography and alter the drainage of the area.

During this period, transition to a colder climate is expected, which has consequences for the terrestrial vegetation as well as for shoreline displacement, as discussed in the introduction to this section.